

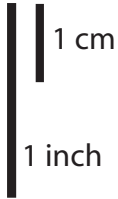

SPACE-X "Falcon-9 v1.1"

Print on Cardstock (110 lbs)



SES-8

1:100 Scale



FALCON 9

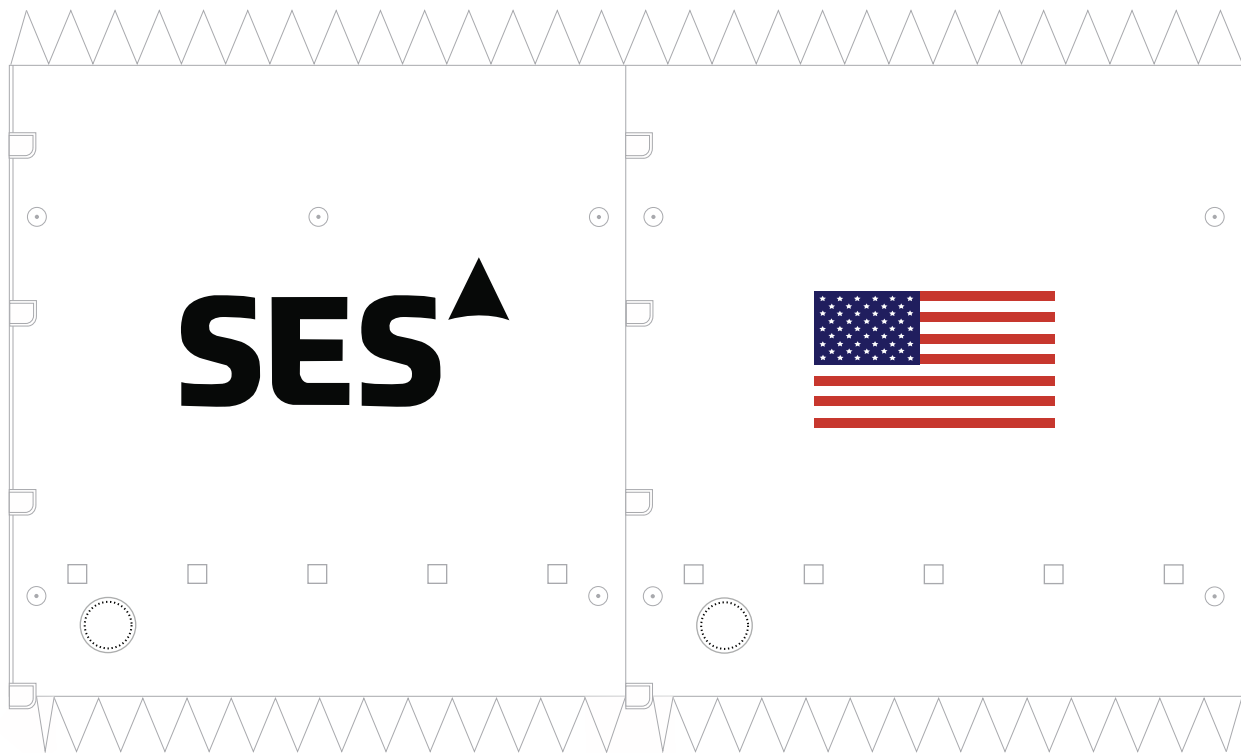
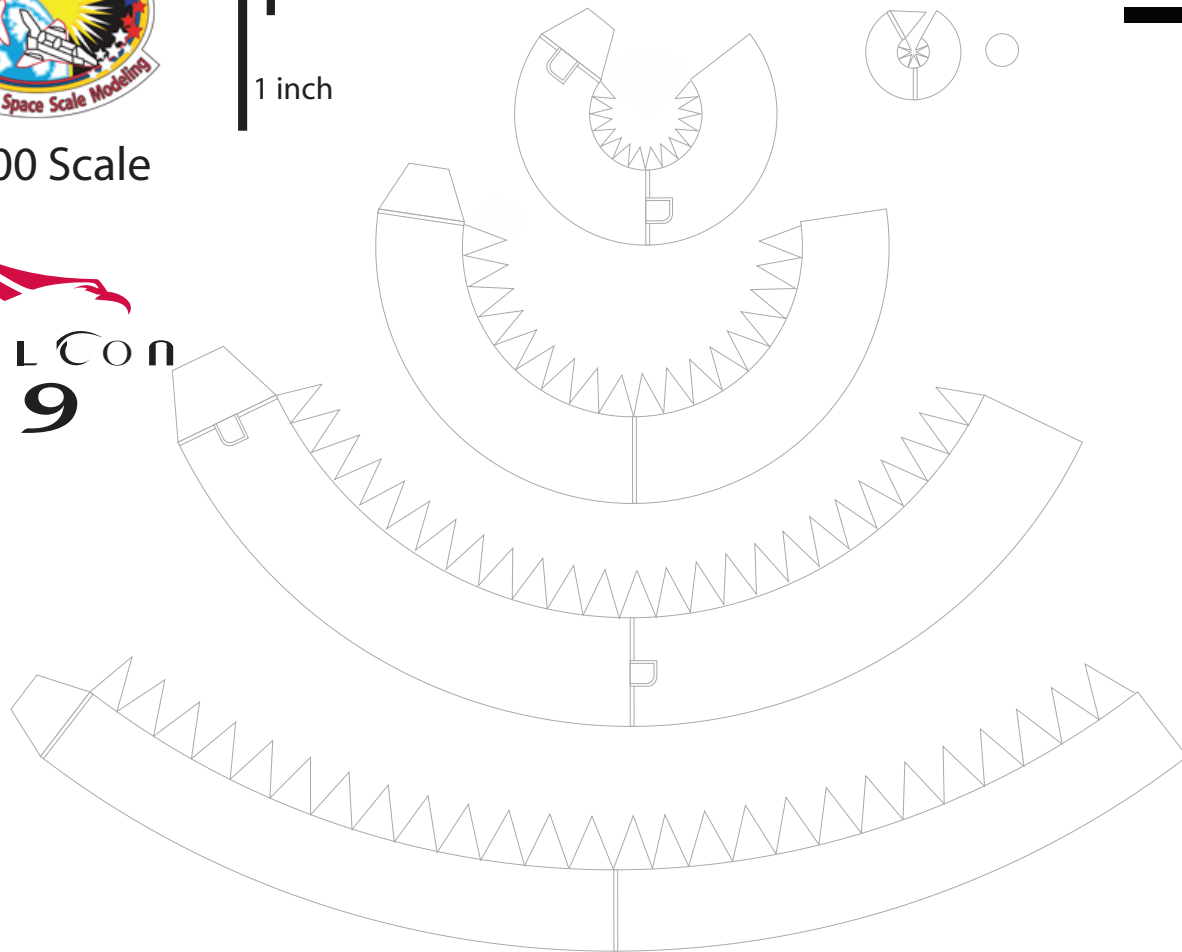



1:100 Scale



SPACE-X "Falcon-9 v1.1"

Print on Cardstock (110 lbs)

Rev 9/14

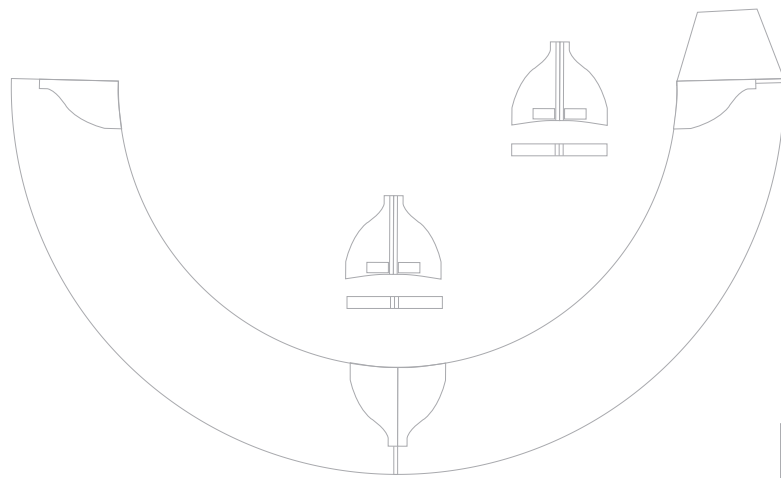
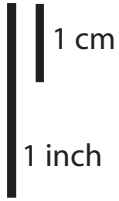

Second Stage / Interstage

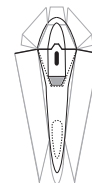
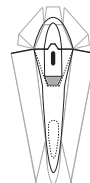
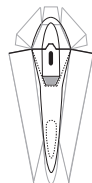
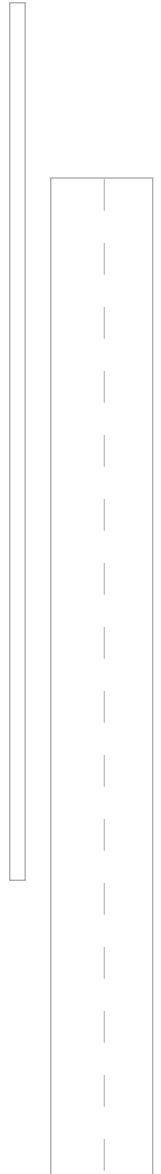
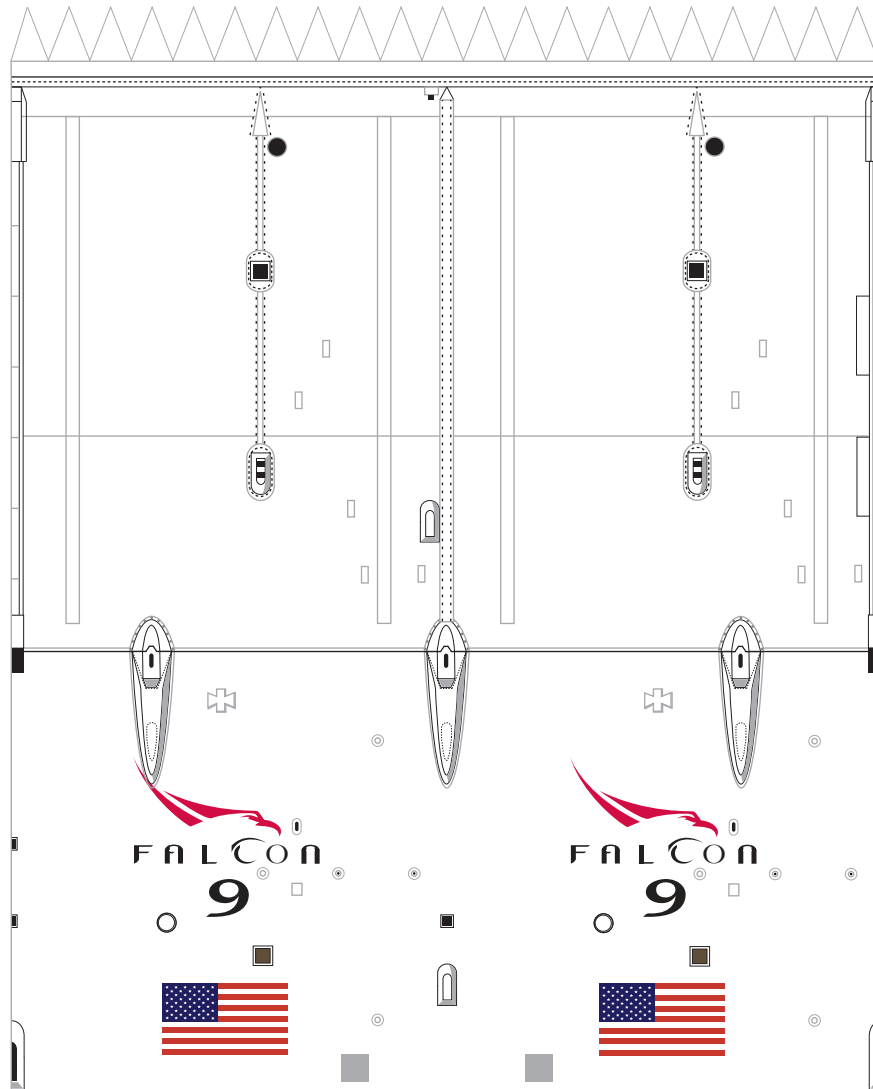
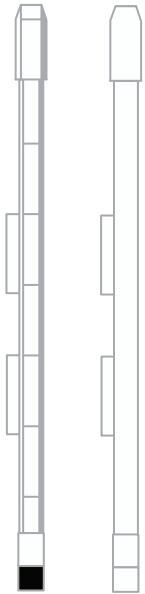



1:100 Scale



FALCON
9

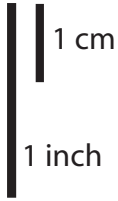

SPACE-X "Falcon-9 v1.1"

Print on Cardstock (110 lbs)

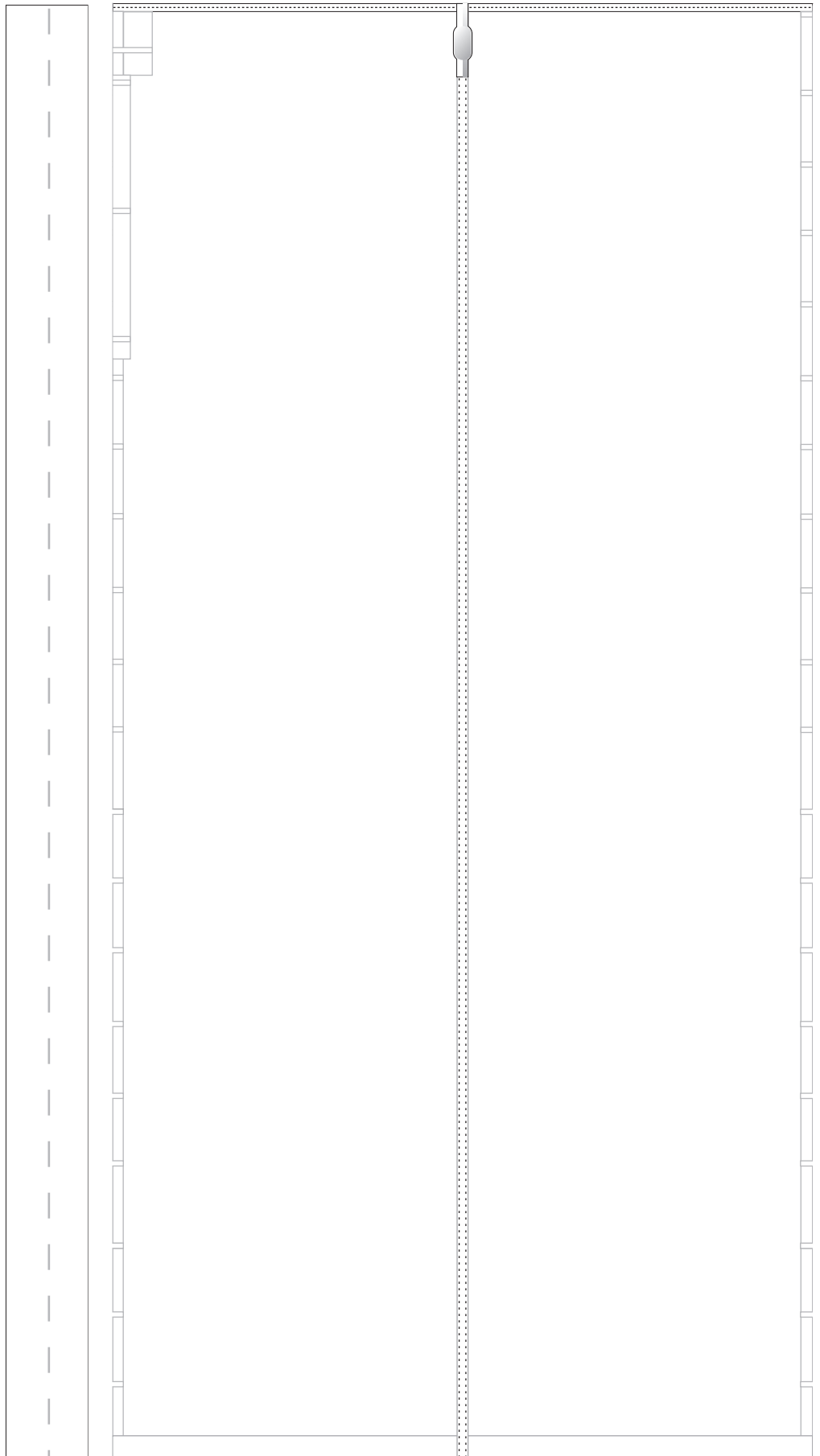
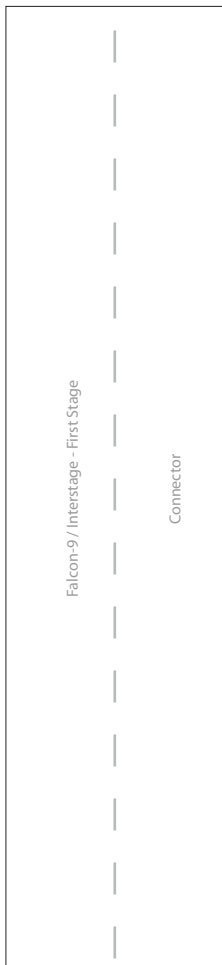



1:100 Scale



FALCON
9

SPACE-X "Falcon-9 v1.1"

Print on Cardstock (110 lbs)

(No legs, SpaceX logo lower)

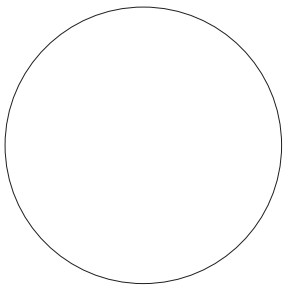
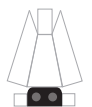
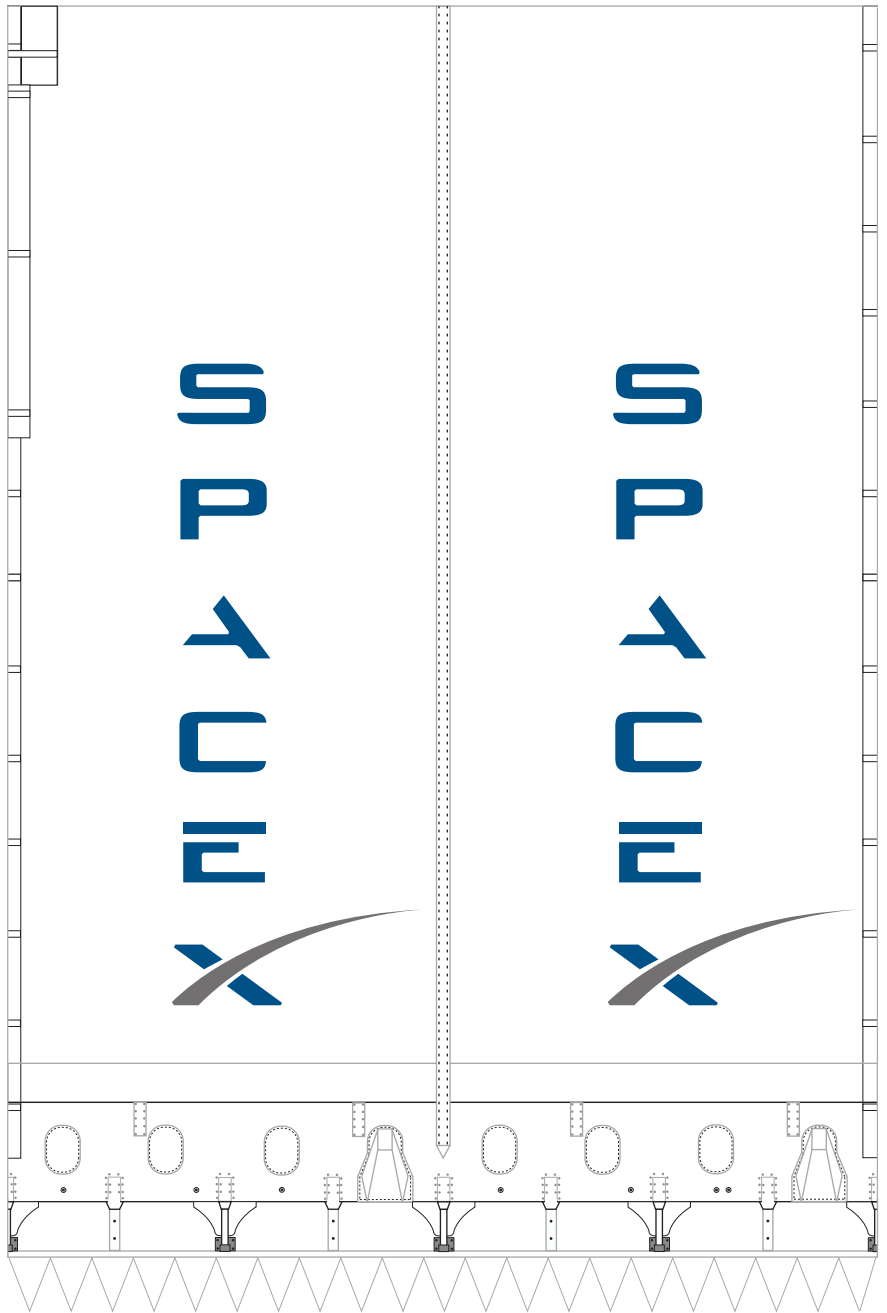
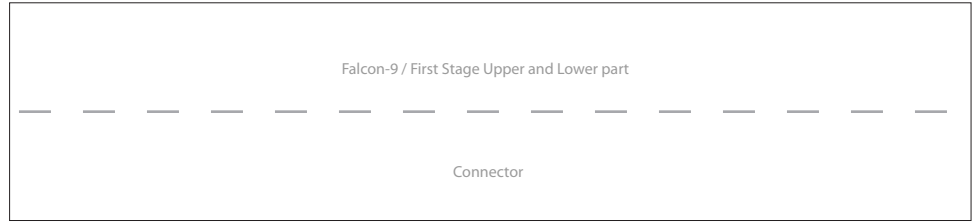



1:100 Scale



SPACE-X "Falcon-9 v1.1"

MERLIN Engines

Print on Cardstock (110 lbs)

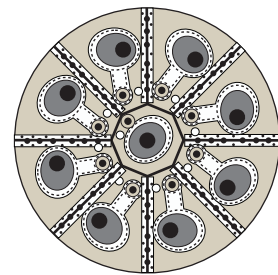
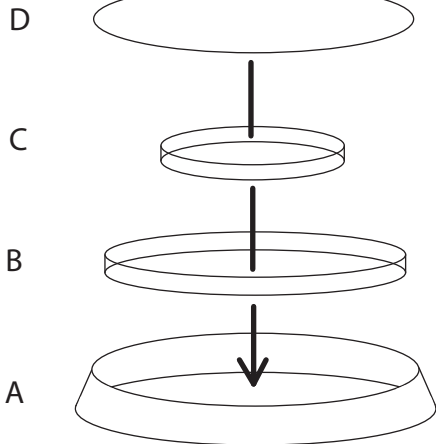
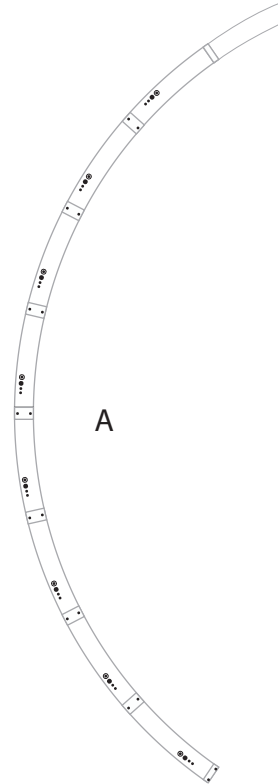
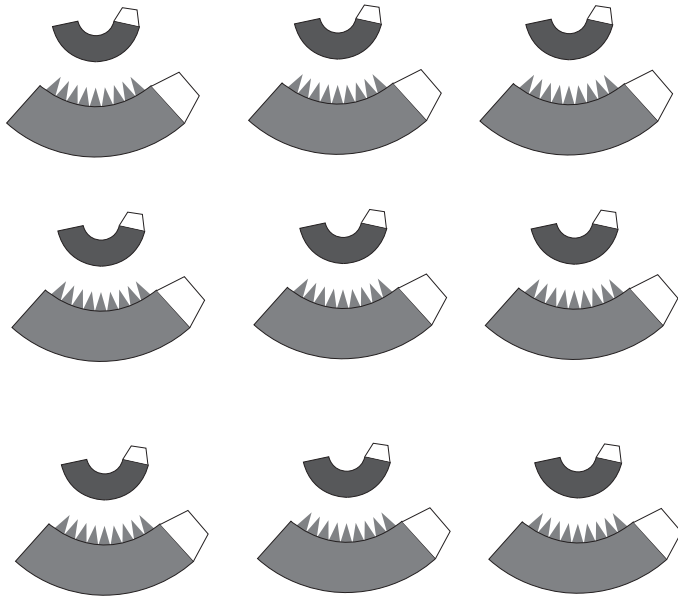

Engine Grid
OCTAWEB



1:100 Scale

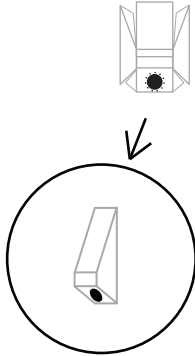

SPACE-X "Falcon-9 v1.1"

Umbilical Tray

Print on Cardstock (110 lbs)

