

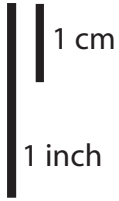

SPACE-X "Falcon-9 v1.1"

Print on Cardstock (110 lbs)



THAICOM 6

Rev. 1

1:100 Scale



FALCON 9

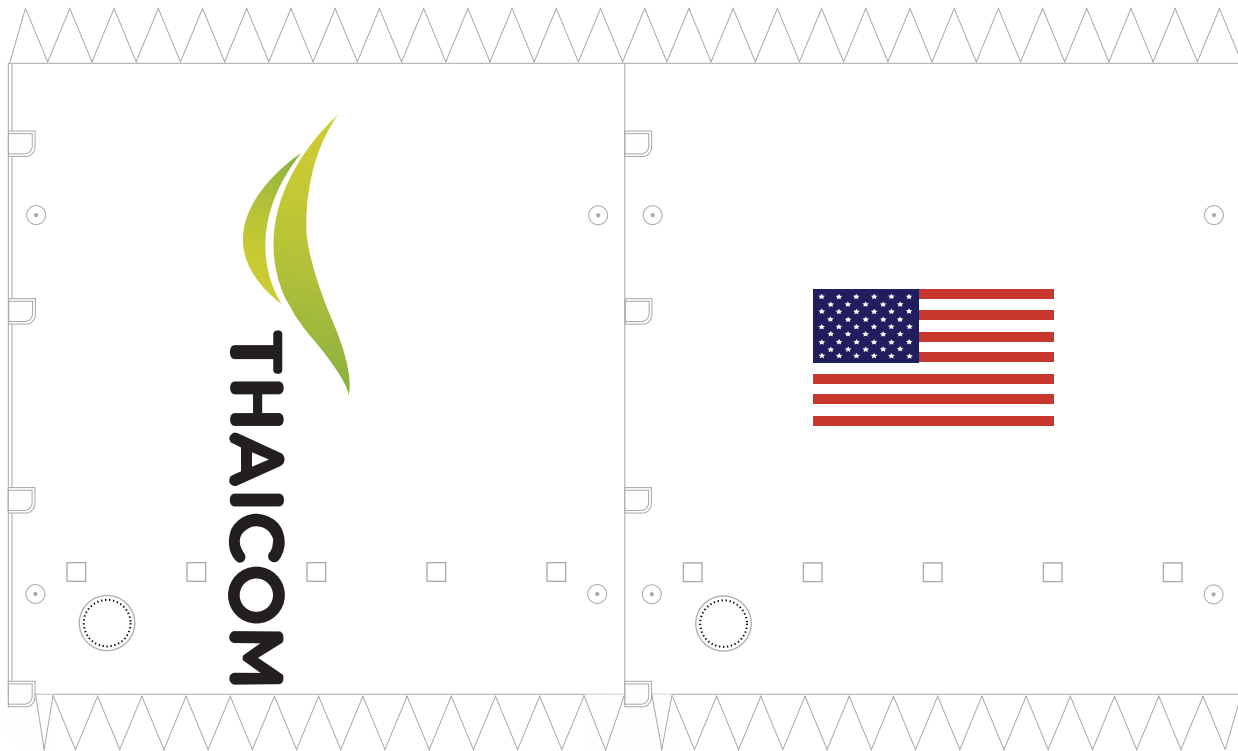
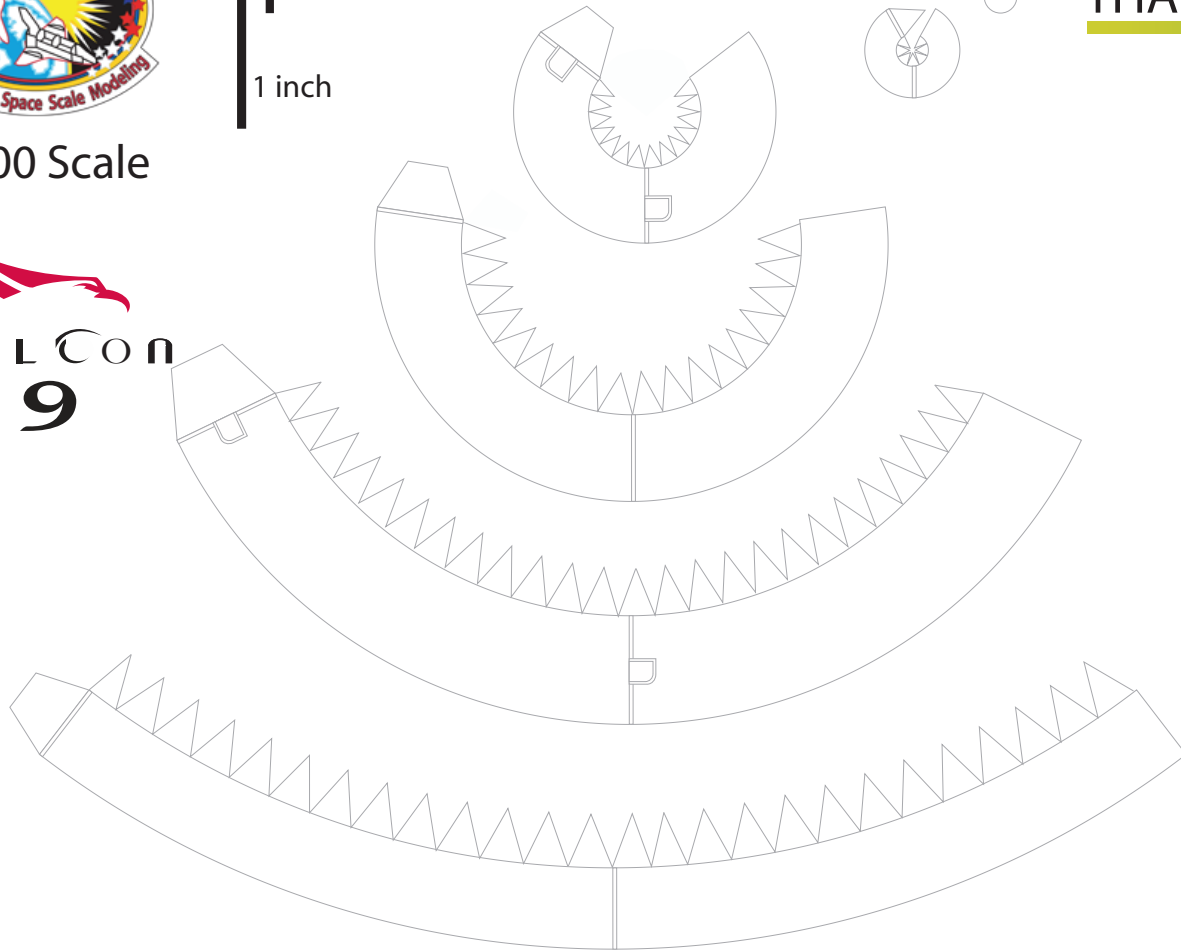



SPACE-X "Falcon-9 v1.1"

Print on Cardstock (110 lbs)

Rev 9/14

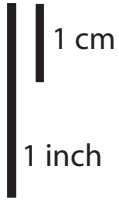

1:100 Scale

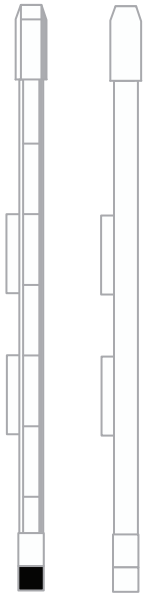
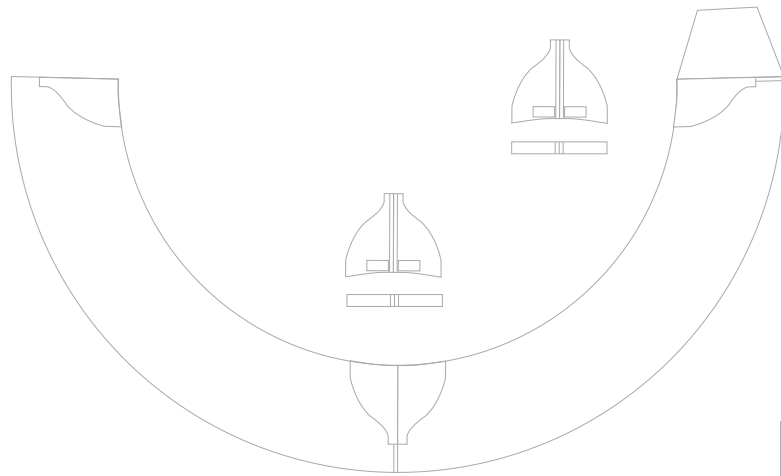

Second Stage / Interstage

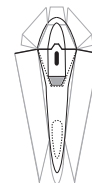
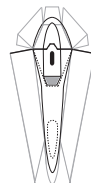
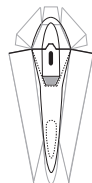
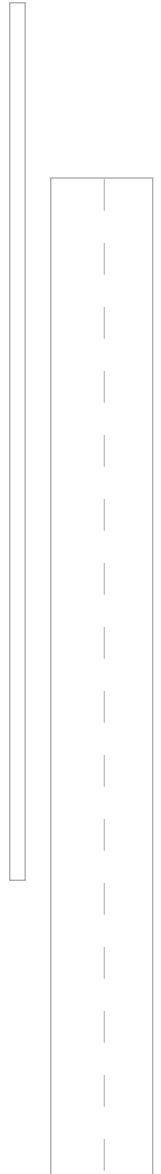
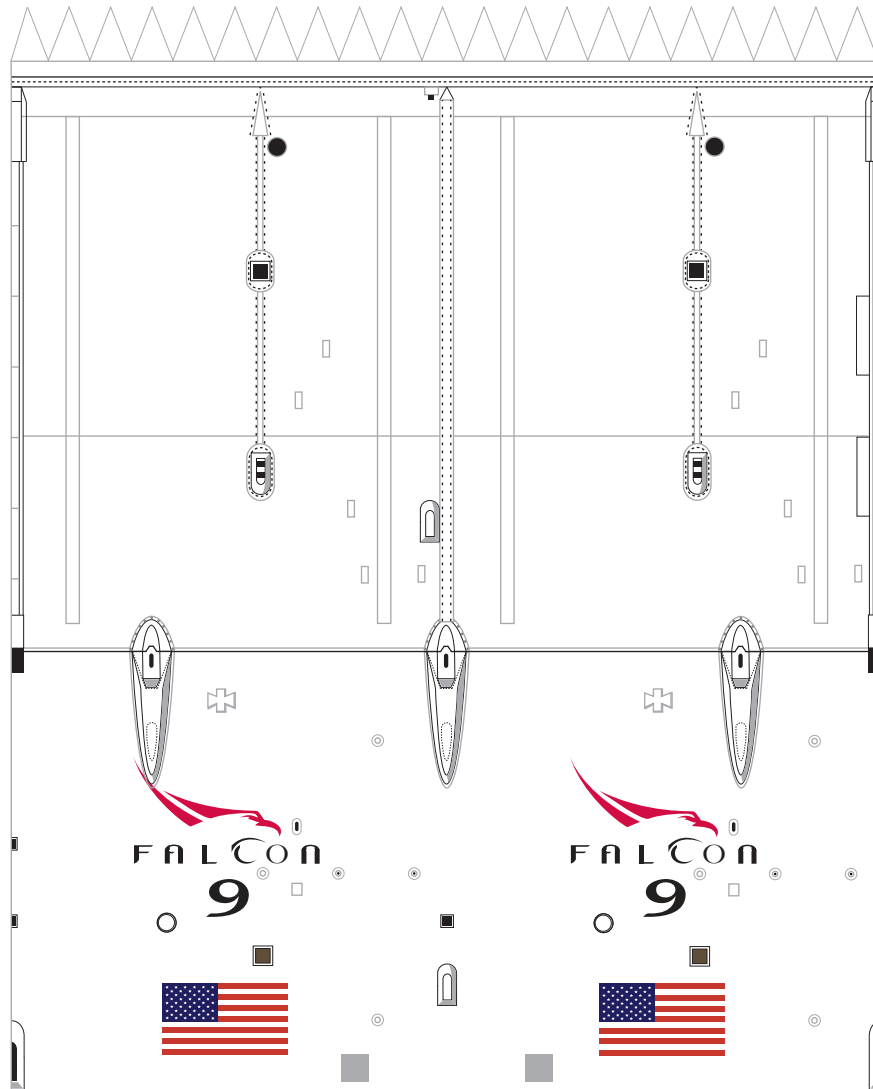



1:100 Scale



FALCON
9

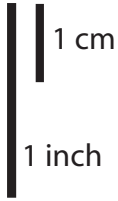

SPACE-X "Falcon-9 v1.1"

Print on Cardstock (110 lbs)

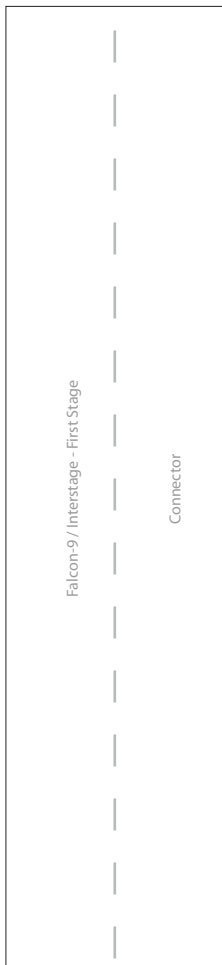

Connector

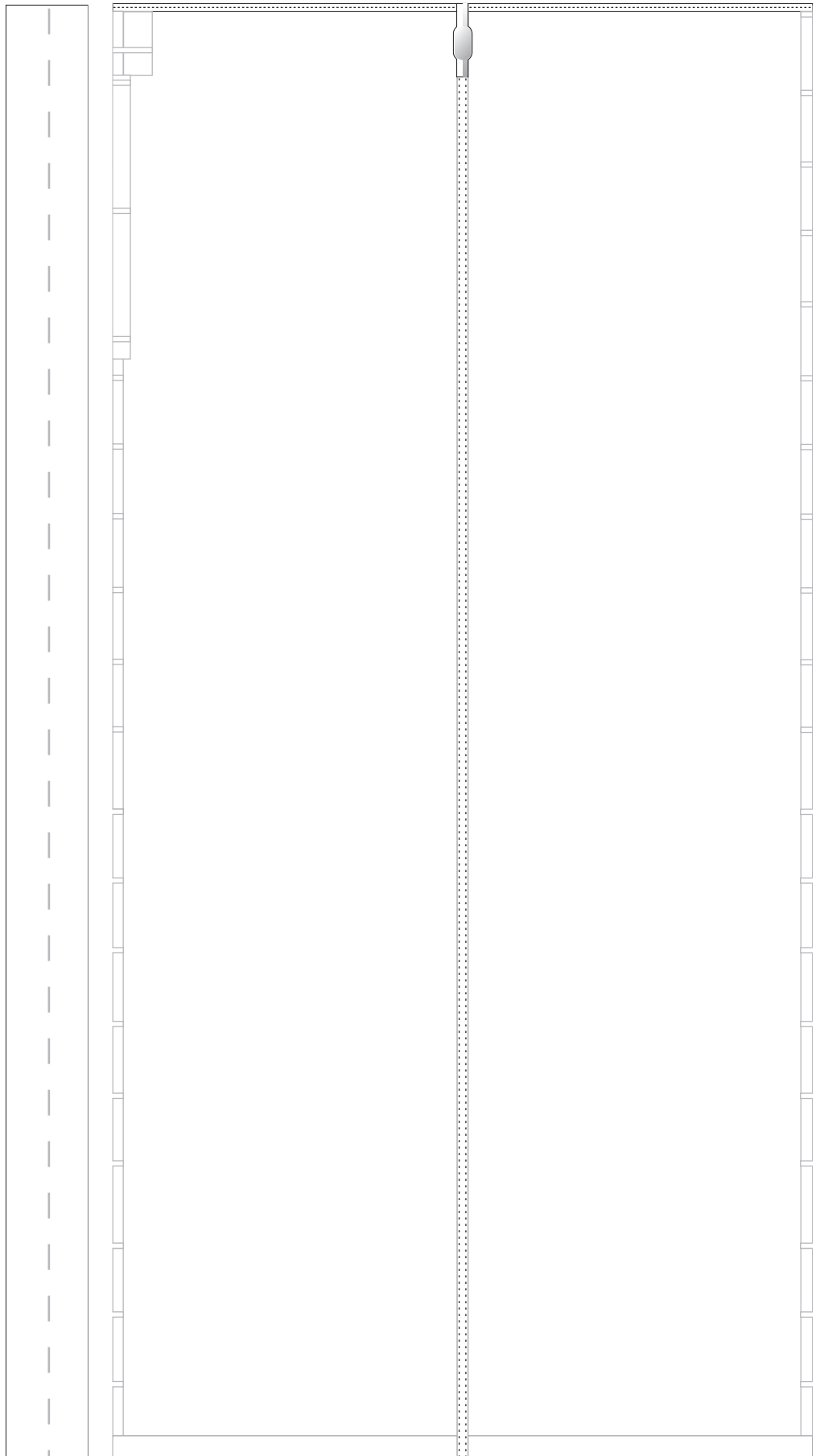



1:100 Scale



FALCON
9

SPACE-X "Falcon-9 v1.1"

Print on Cardstock (110 lbs)

(No legs, SpaceX logo lower)

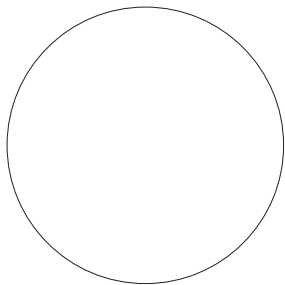
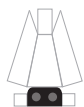
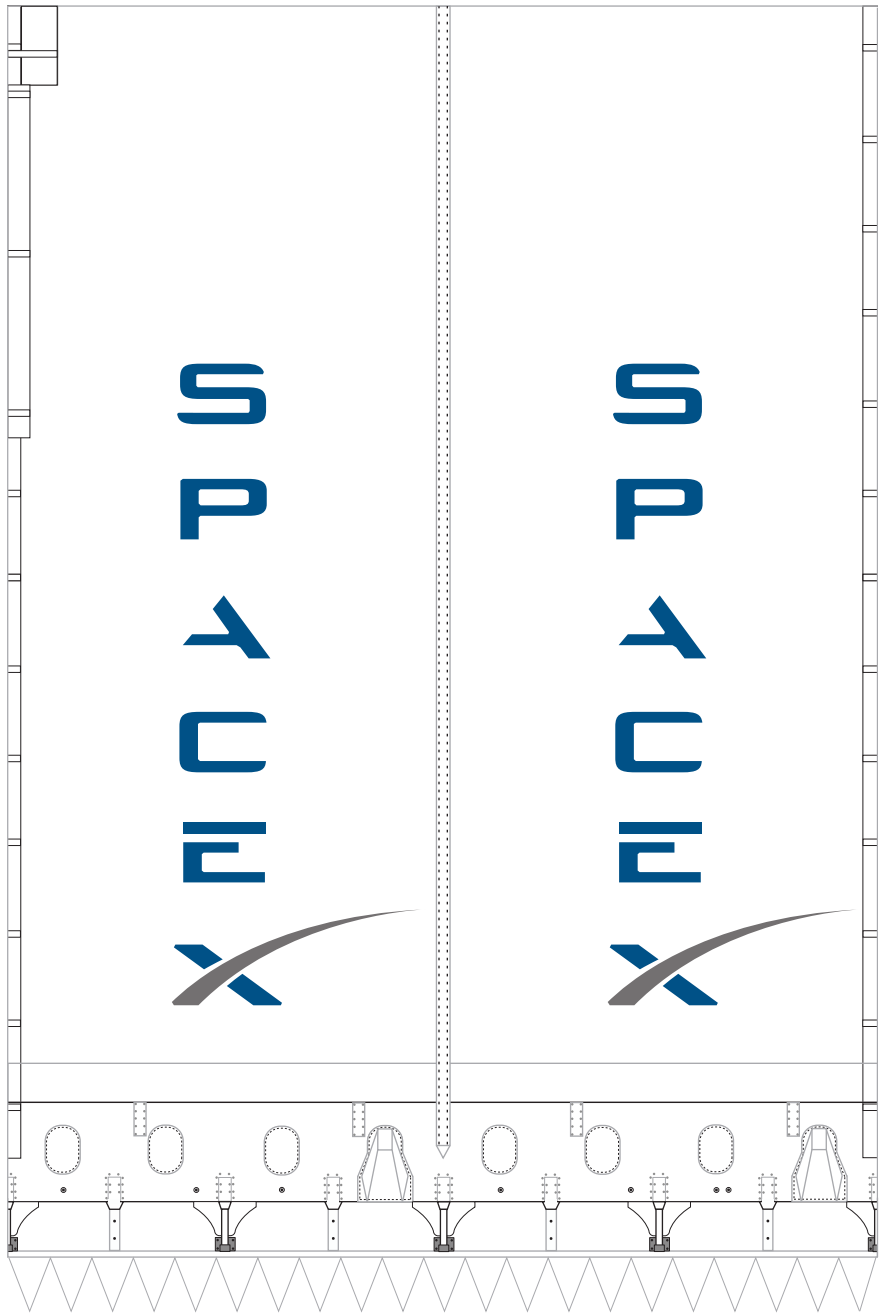
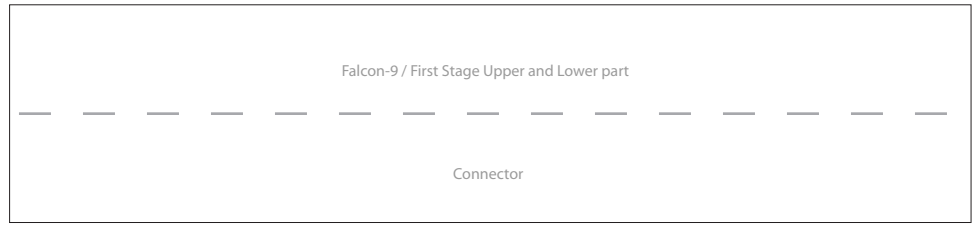
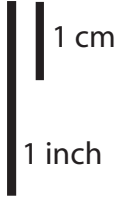



1:100 Scale



SPACE-X "Falcon-9 v1.1"

MERLIN Engines

Print on Cardstock (110 lbs)

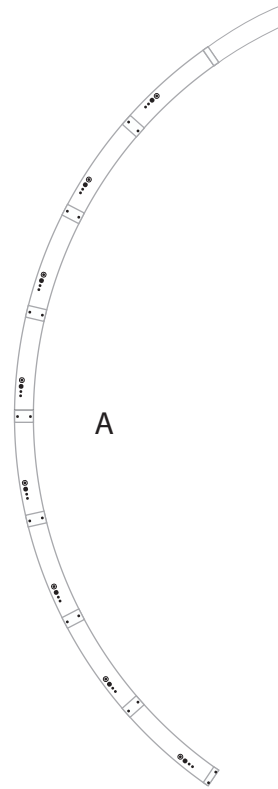
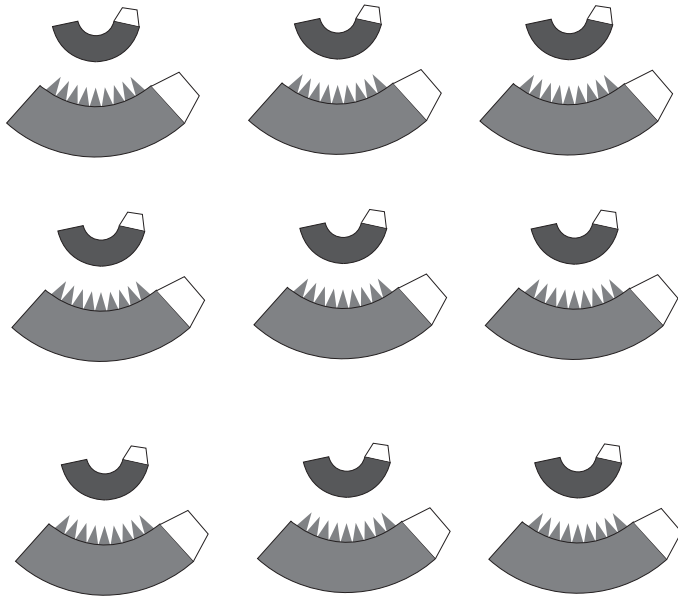

D
C
B
A

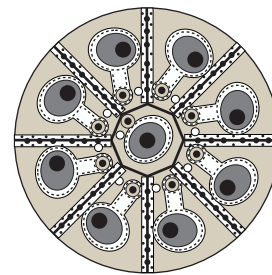
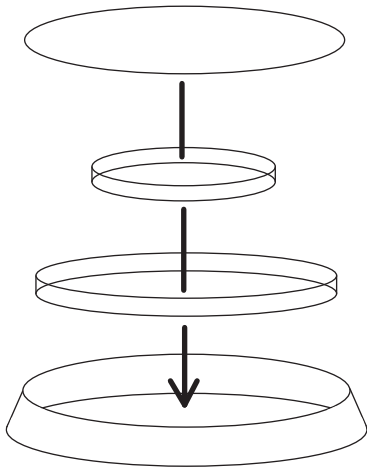

Engine Grid
OCTAWEB



1:100 Scale

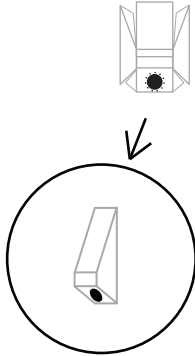

SPACE-X "Falcon-9 v1.1"

Umbilical Tray

Print on Cardstock (110 lbs)

