



1 cm  
1 inch

# Delta IV Second Stage

Print on Cardstock (110 lbs)

UPDATE

Use the backprint page for the Second Stage when printing this page

1:96 Scale

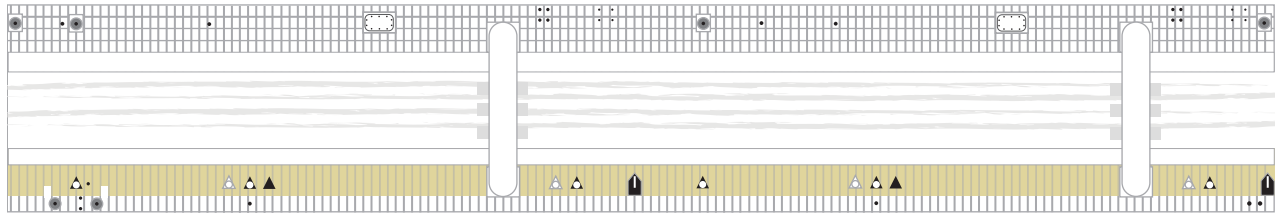

Fuel lines  
to upper  
dome

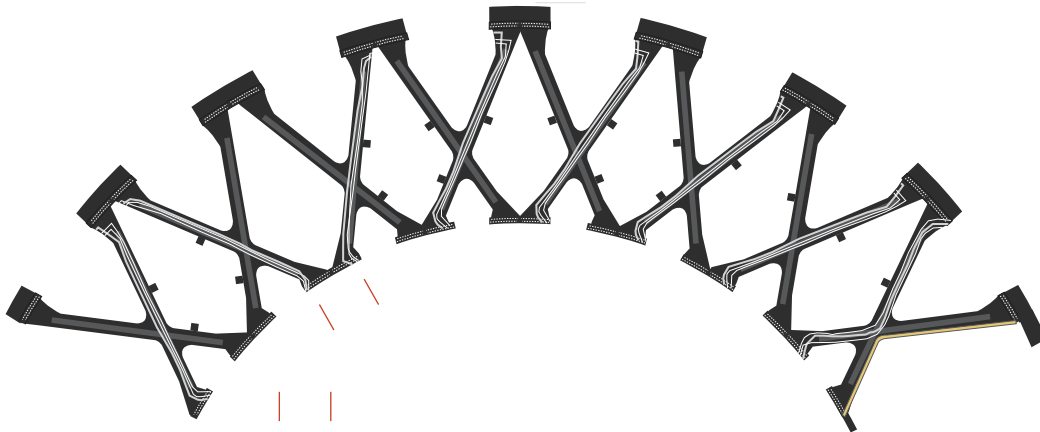

Fuel lines  
to lower  
dome

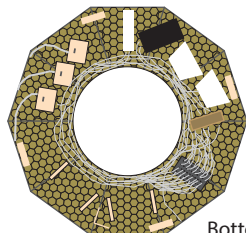
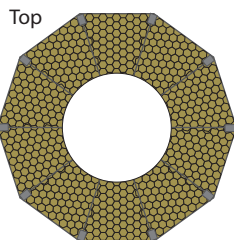
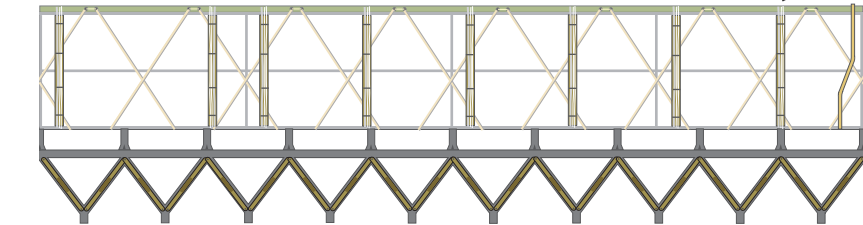
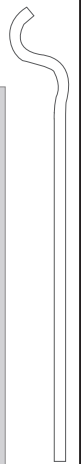

Bottom

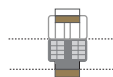
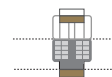
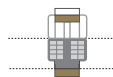
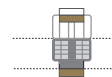

Tanks

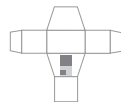
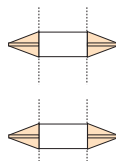
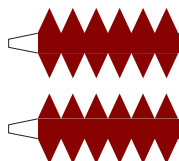



# Delta IV Second Stage

Print on Cardstock (110 lbs)

1:96 Scale

Backside print for Second Stage X Pattern framework





# Delta IV Second Stage

Print on Cardstock (110 lbs)

1:96 Scale

## Second Stage LH2 tank dome

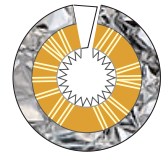
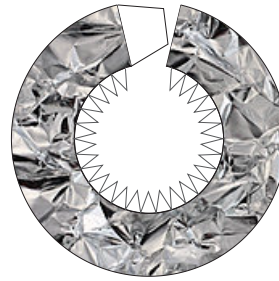
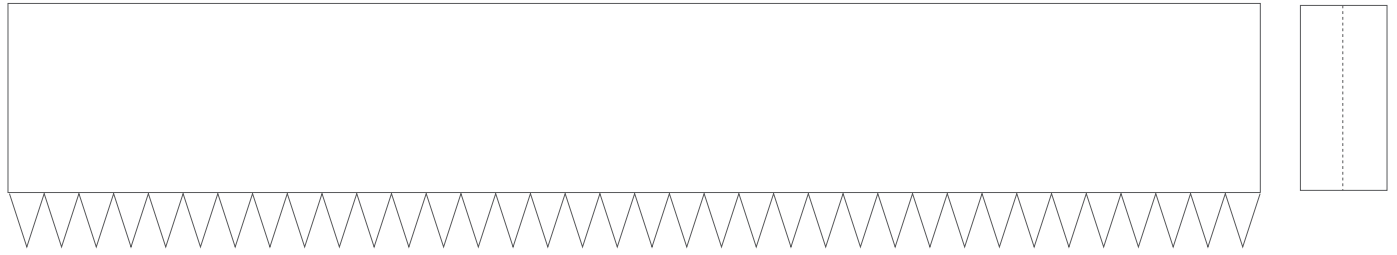

Diagram

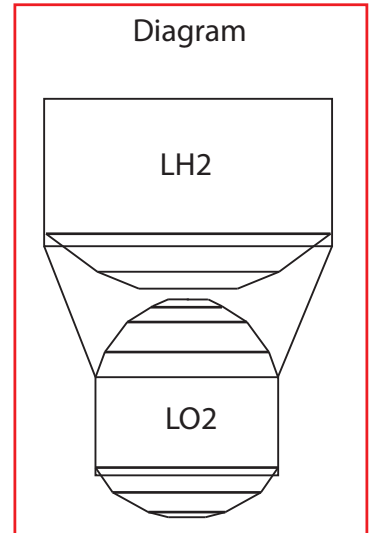



# Delta IV Second Stage

Print on Cardstock (110 lbs)

1:96 Scale

## Second Stage LO2 tank dome

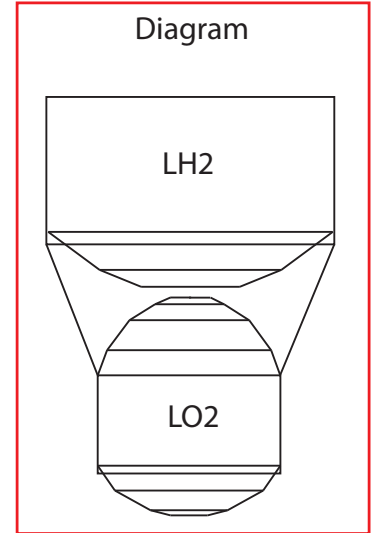
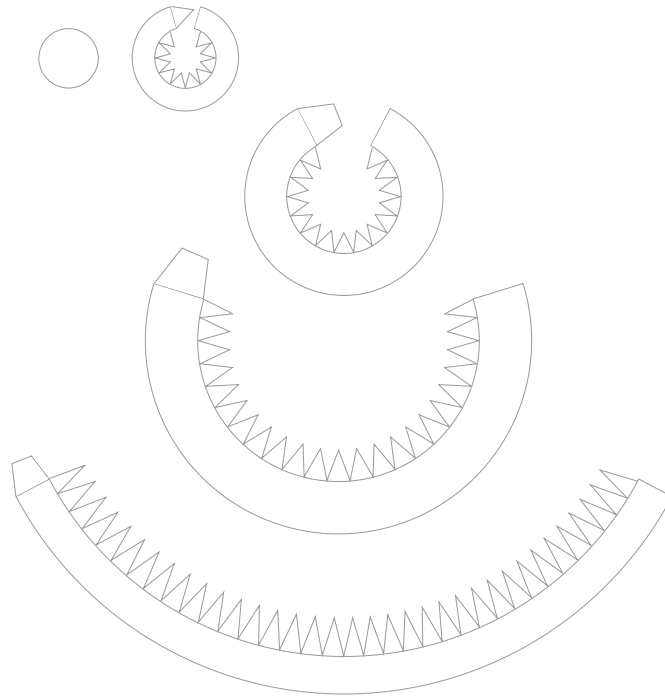



# Delta IV Second Stage

Print on Cardstock (110 lbs)

1:96 Scale

Diagram

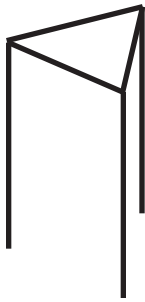

Exterior



Interior

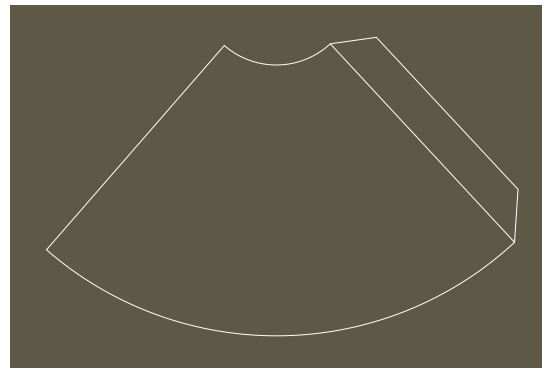
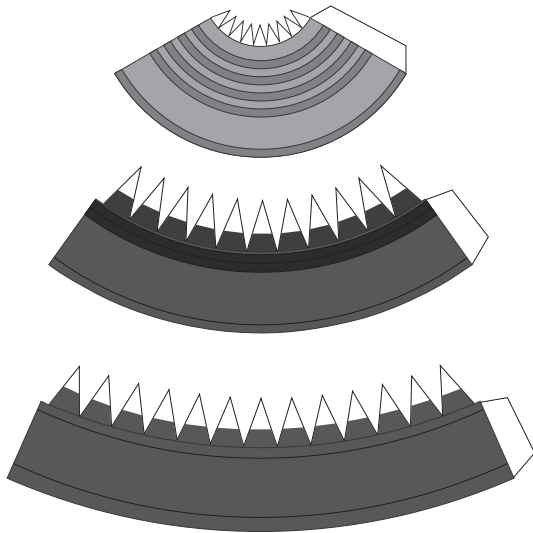
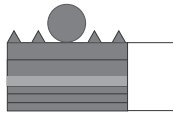

Pratt & Whitney RL10B-2 Engine