

Building the Shenzhou crew vehicle

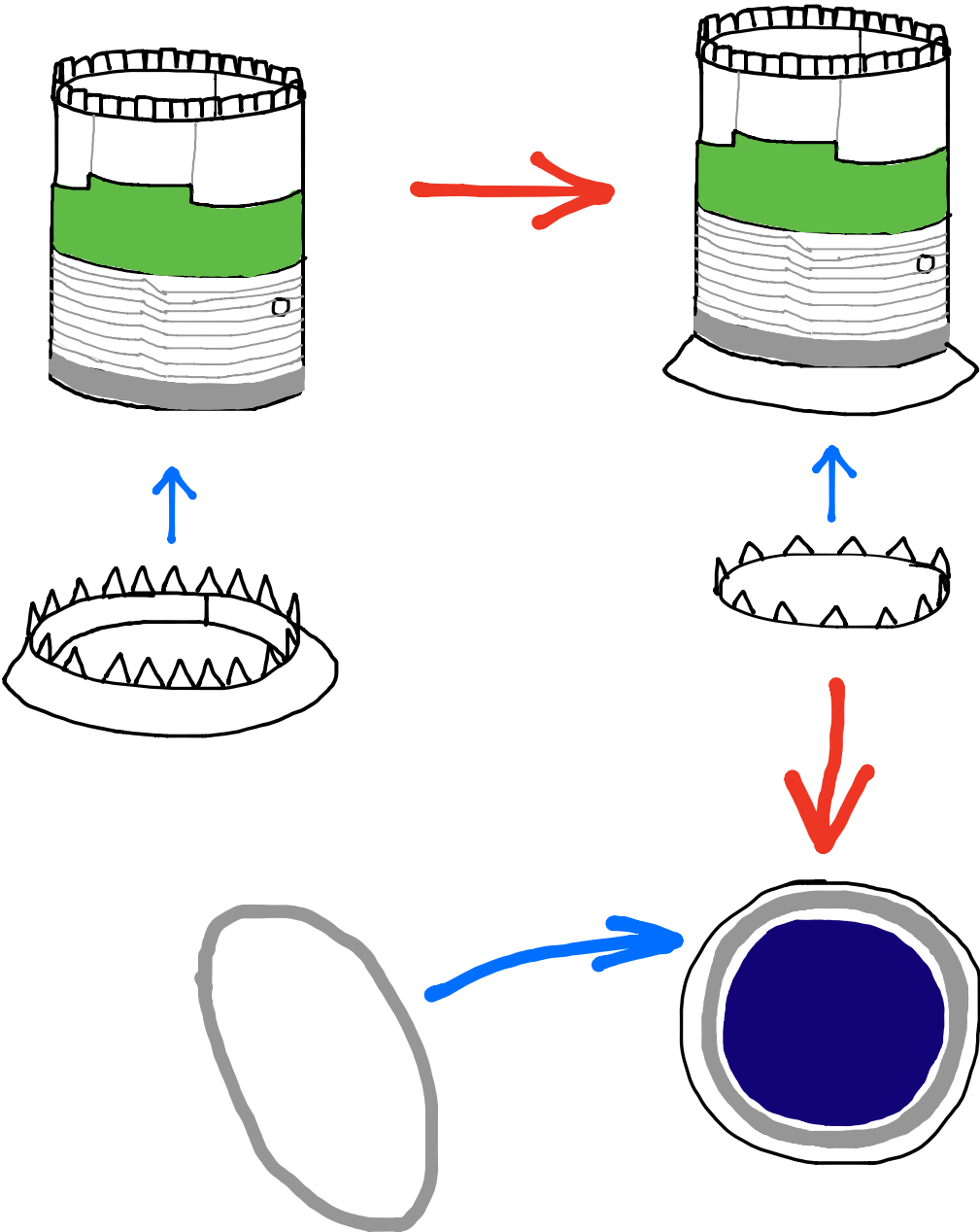

Glue inner ring

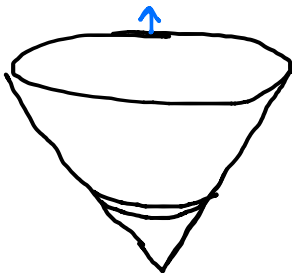

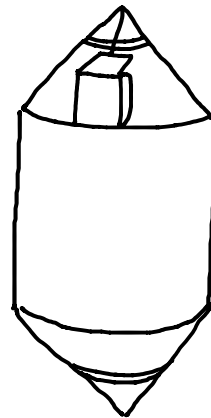
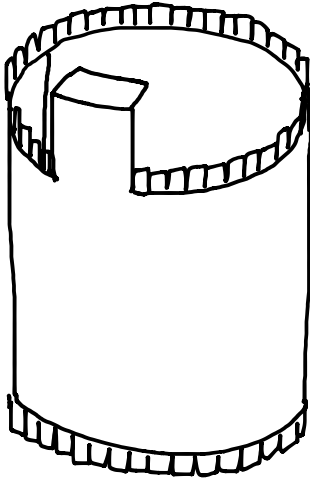
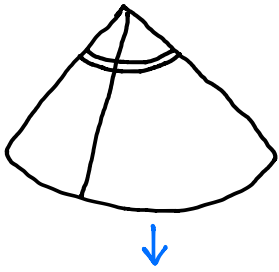
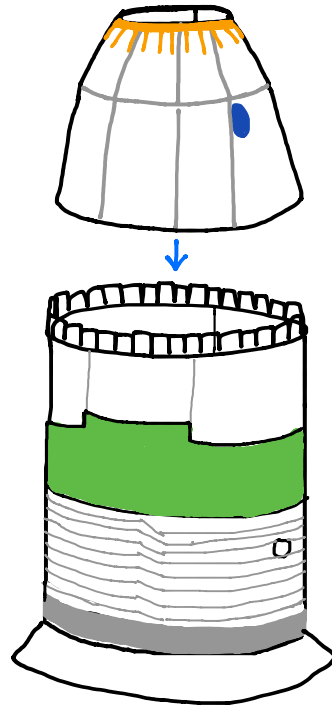
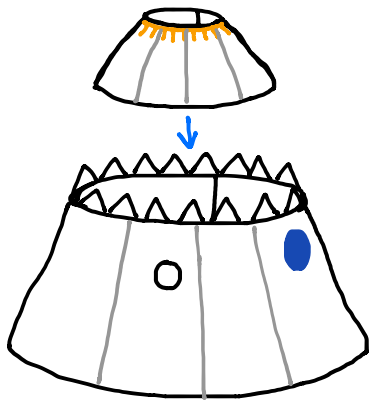
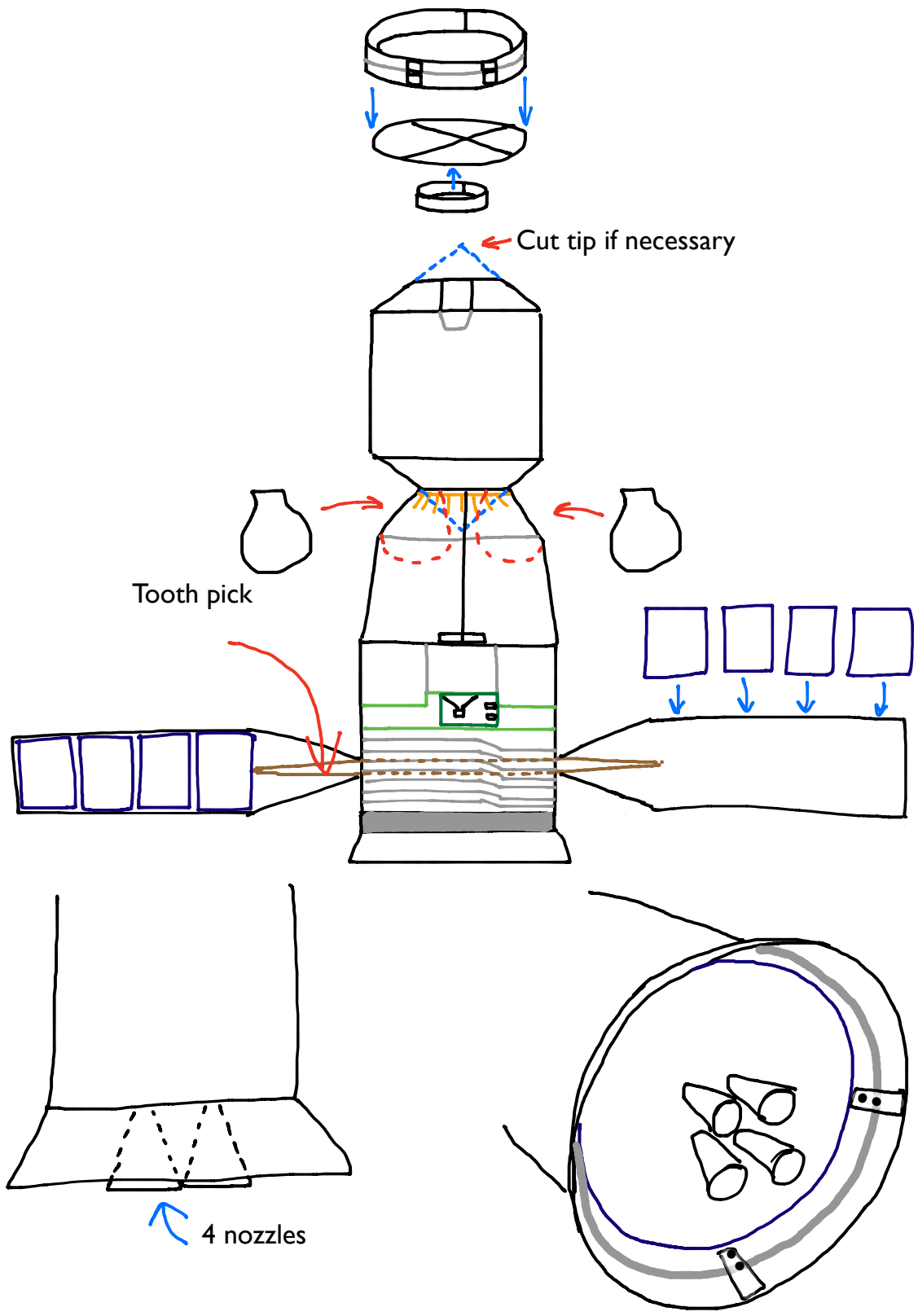

Add extra small parts and glue on top of markings

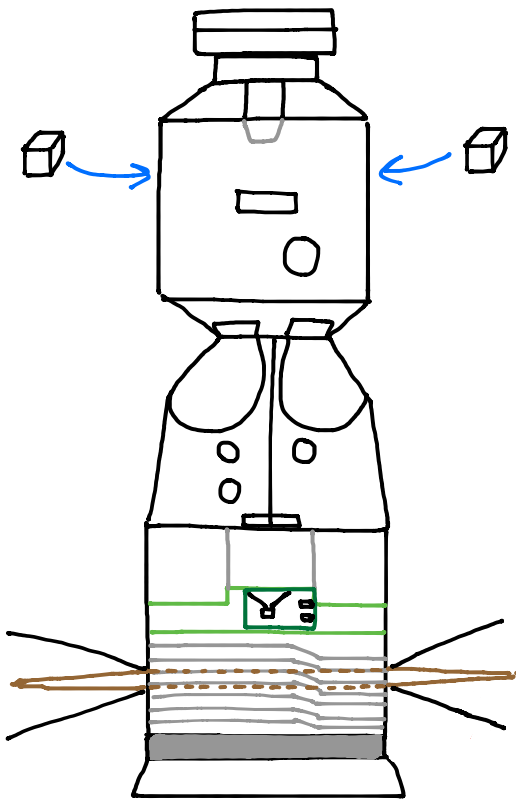

Back

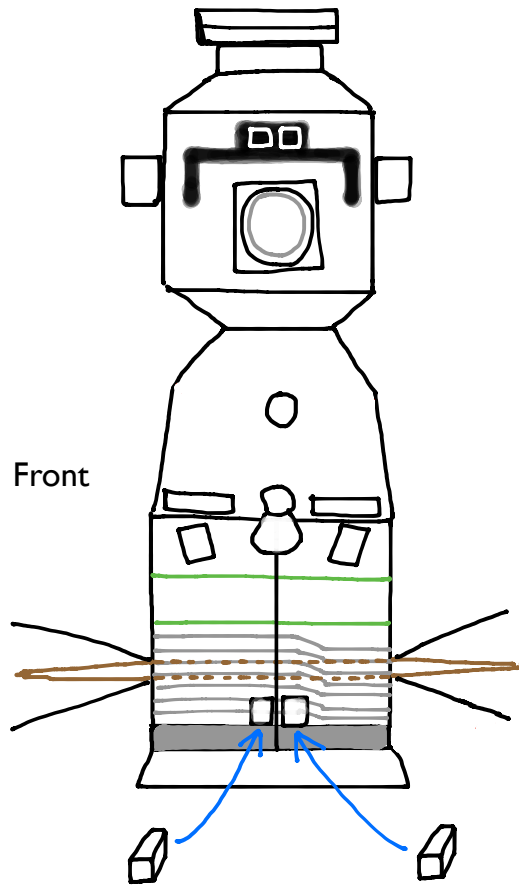

Front

Building the Tiangong-I

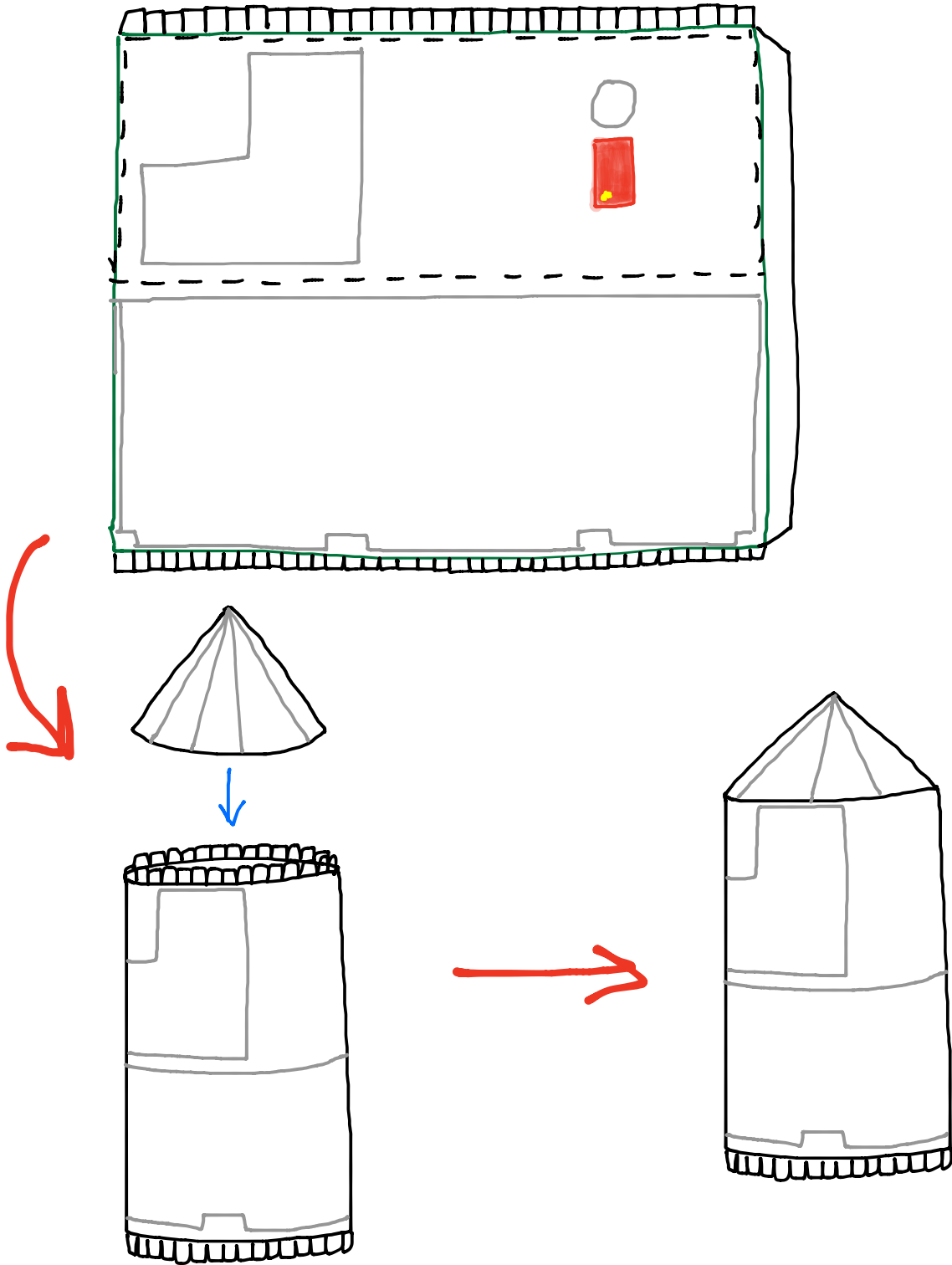

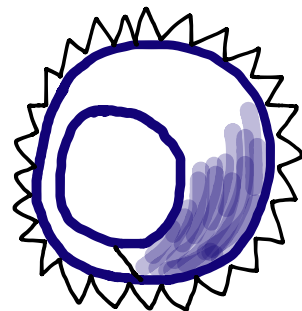
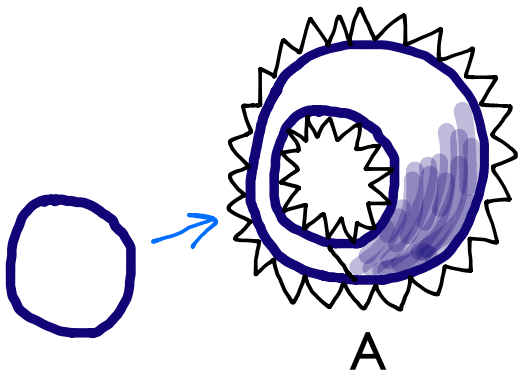
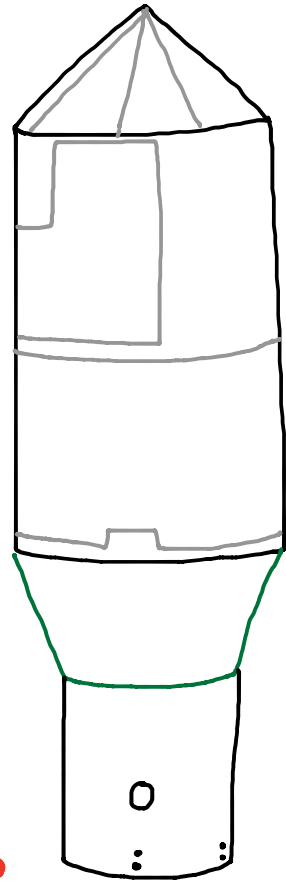
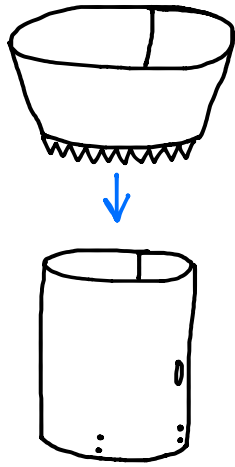

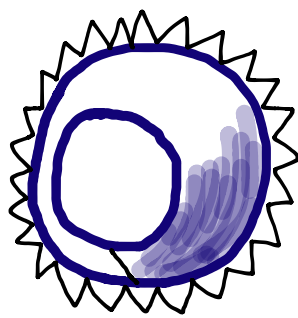

A

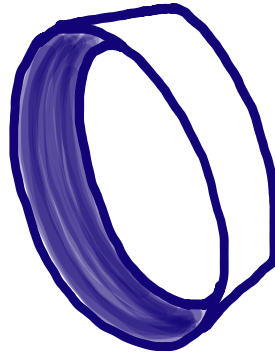

B

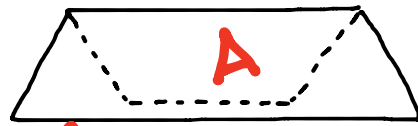

B ↑

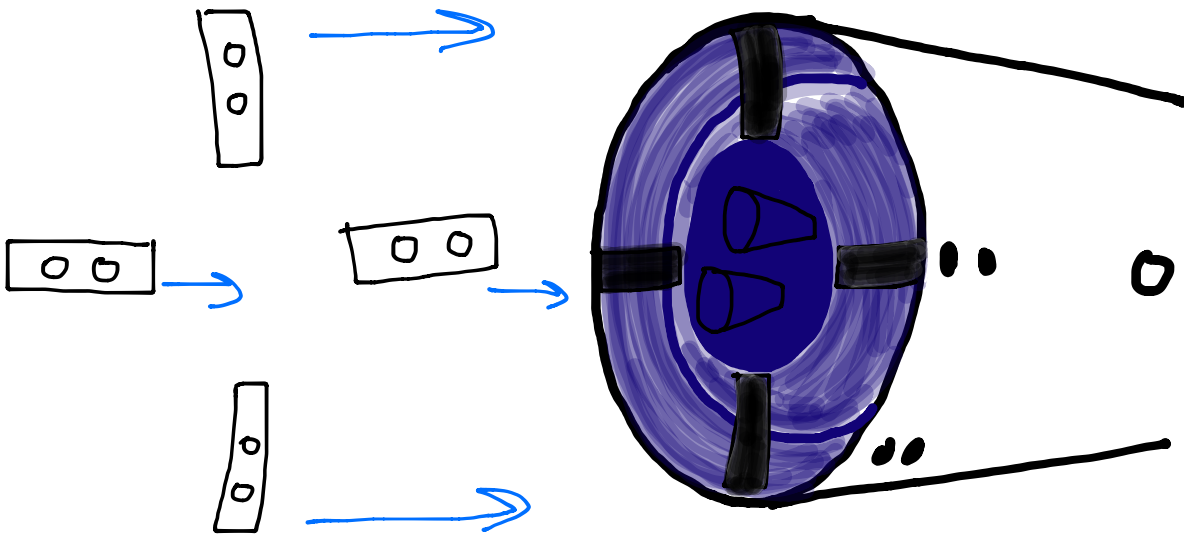

2 nozzles



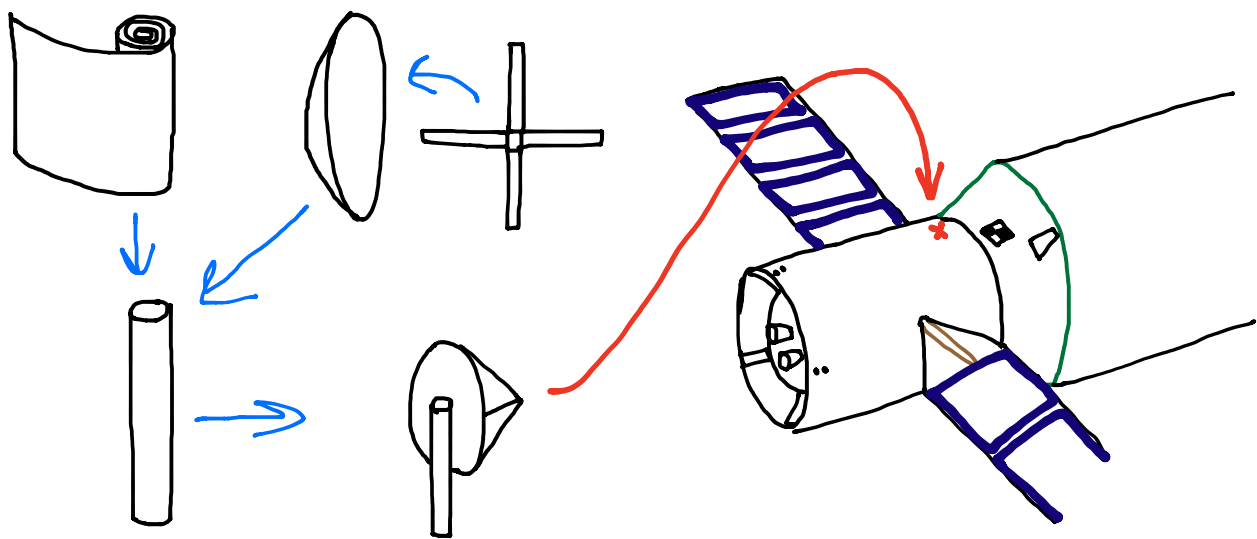
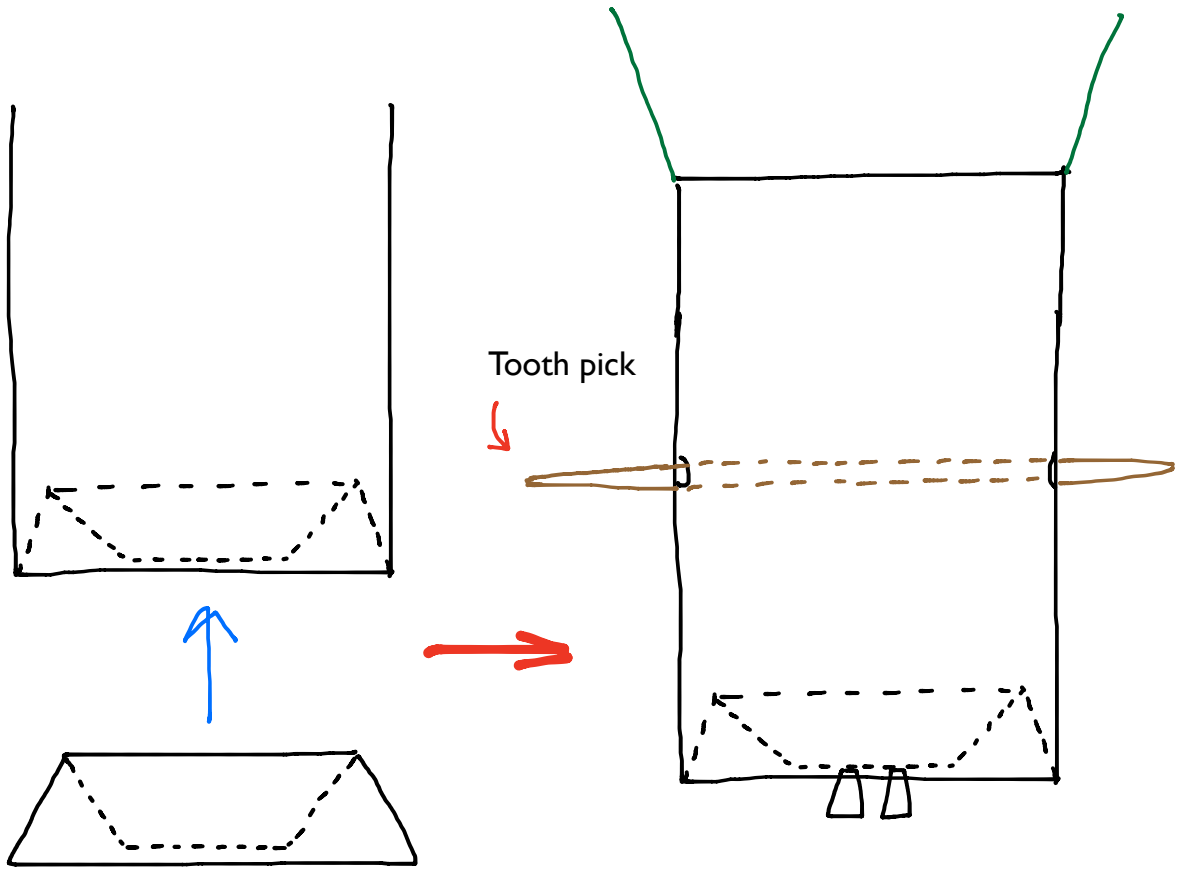

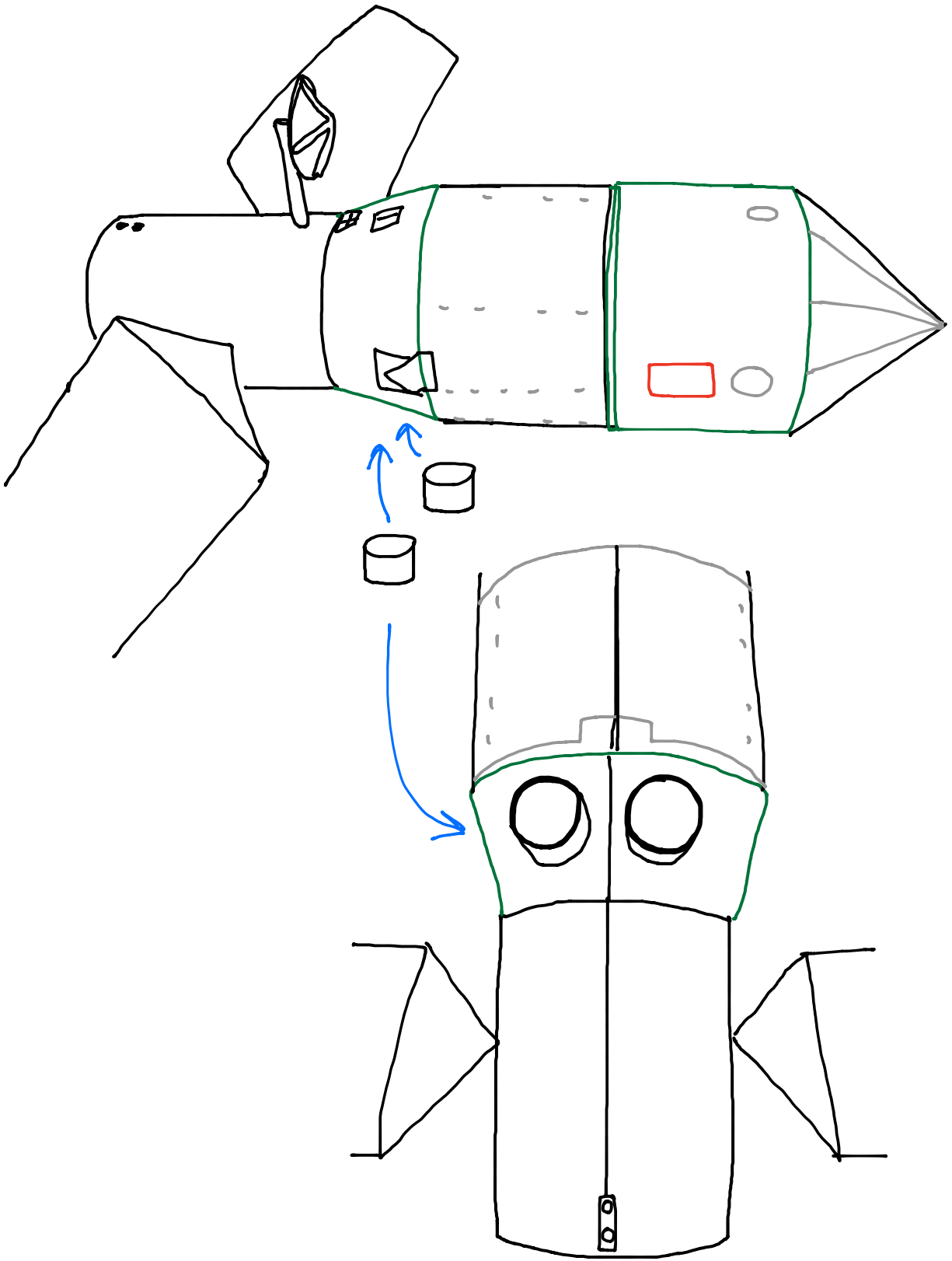

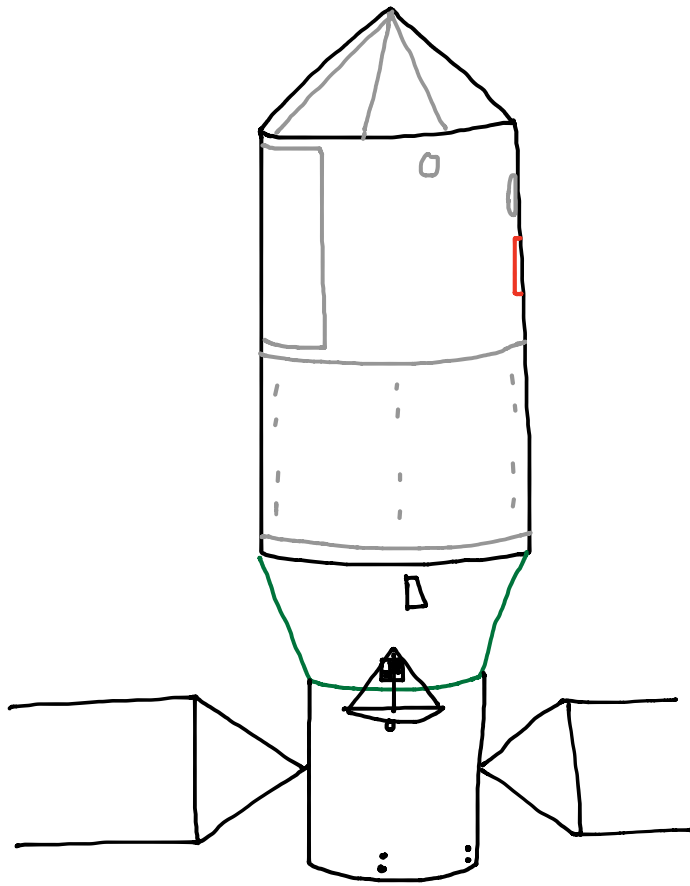

Top

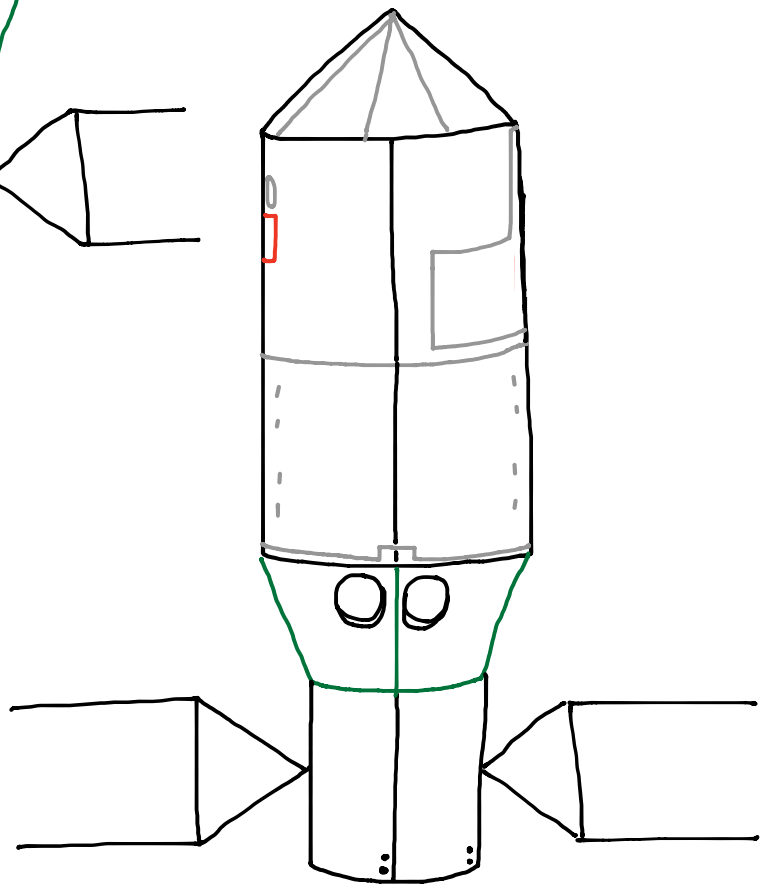

Bottom

Glue both models together for display

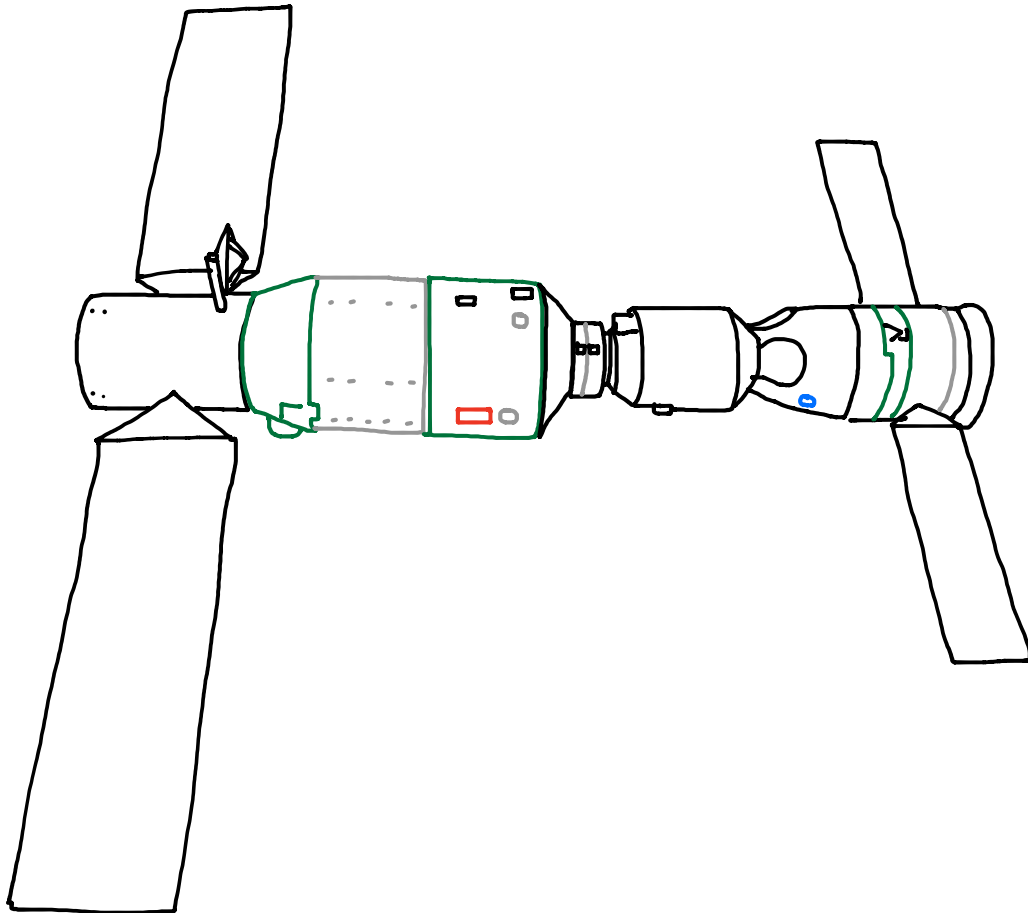

2013

Models designed by Marcel Kukuricáš
Graphics by Alfonso X Moreno