



1 cm
1 inch

ATLAS V STARLINER OFT-2

ISS Docking Configuration

Print on Cardstock (110 lb)

1:100 Scale

Place magnet behind black circle

hinge

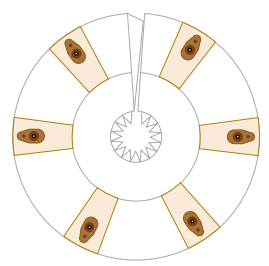
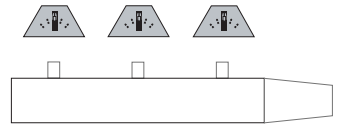
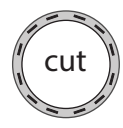
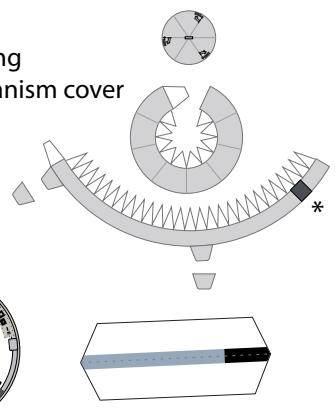

Heatshield seamline to be aligned with capsule's seamline

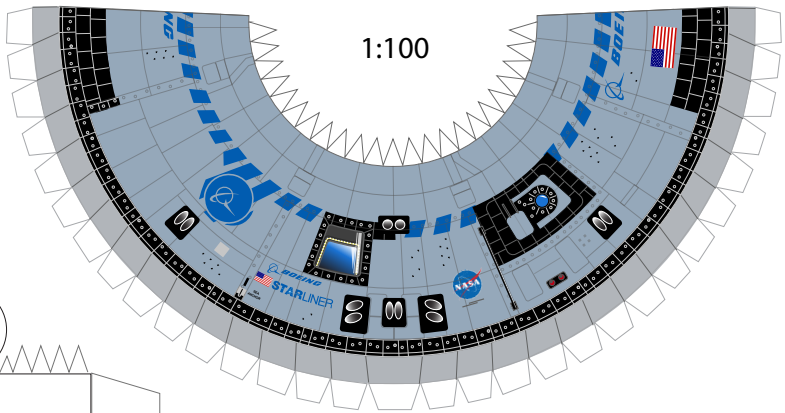

1:100

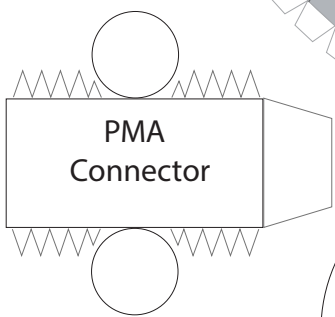
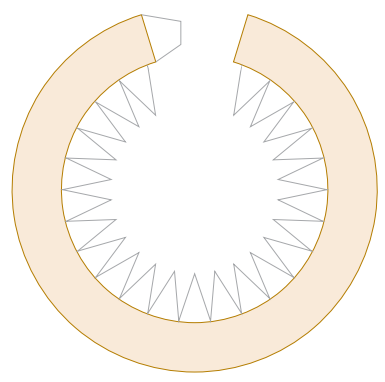

PMA Connector

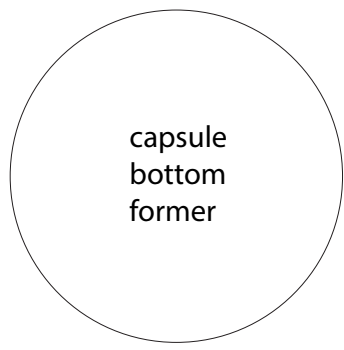
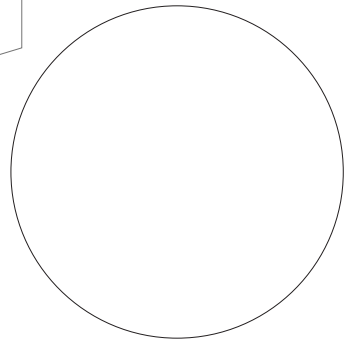

capsule bottom former

Umbilical

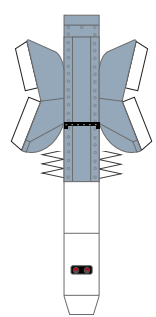

Optional use of magnets inside the PMA connector on both ends (PMA-2 needs to have a hidden magnet as well)

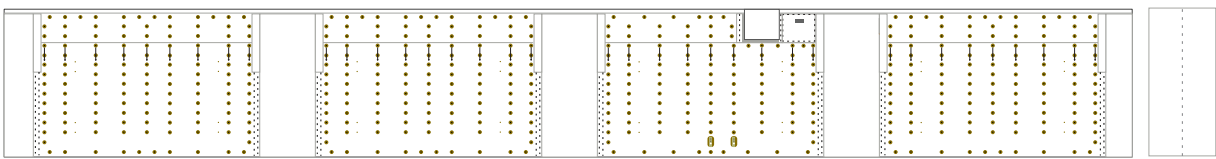
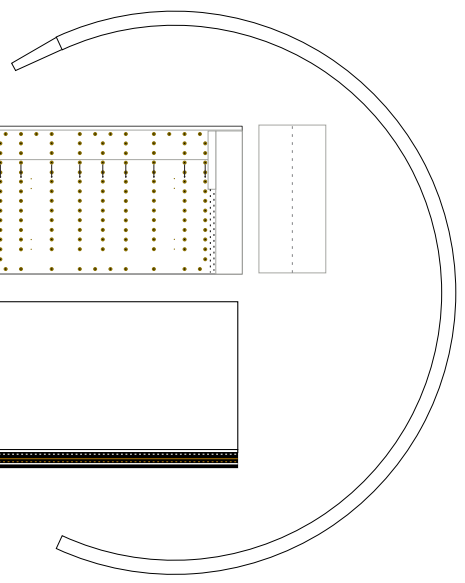

Umbilical



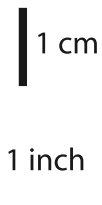

ATLAS V STARLINER

Print on Cardstock (110 lb)

1:100 Scale

Thrusters doghouses

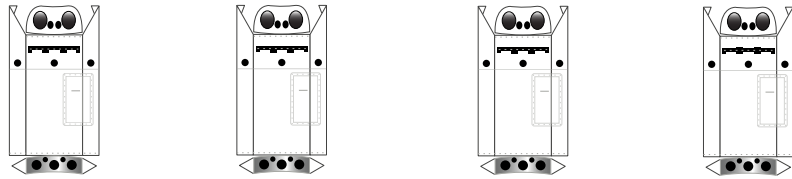

Aero Deflectors (top and bottom sides)

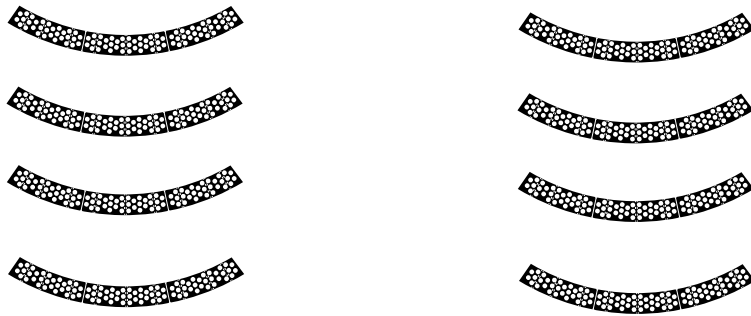

Solar Panel nozzle section

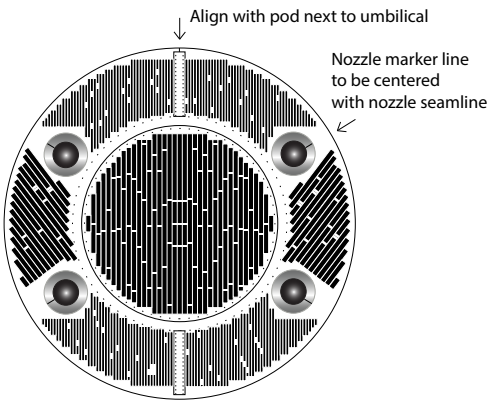

Align nozzle seamline with small marker line

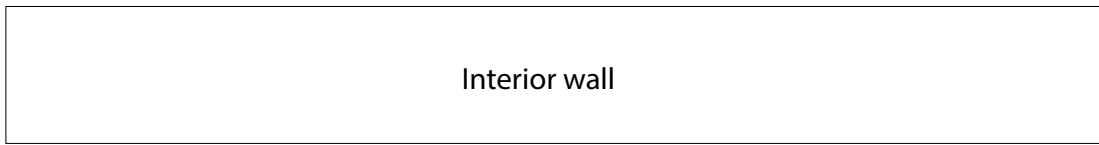
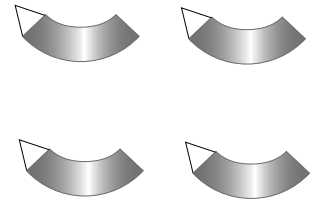

Interior wall

ATLAS V **STARLINER**
Engine nozzles Back Print

