

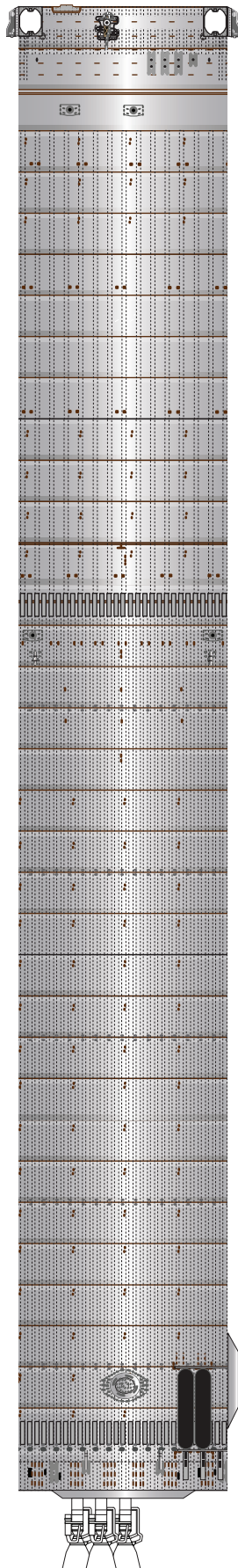

1:100 Scale



BN-3

Belly side

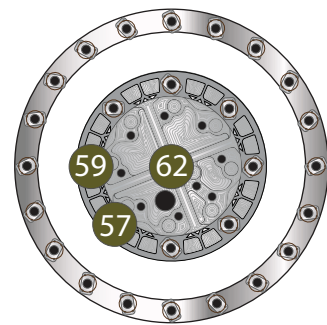

Umbilical side

Designed by Alfonso X Moreno

©2021 Not for commercial use



1 cm

1 inch

1:100 Scale

SpaceX SuperHeavy

Print on Cardstock (110 lbs)

Top ring

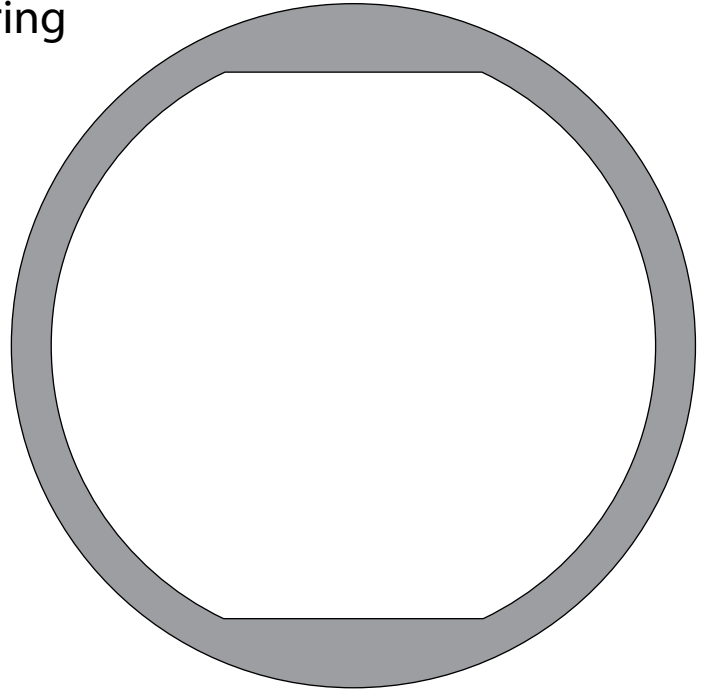
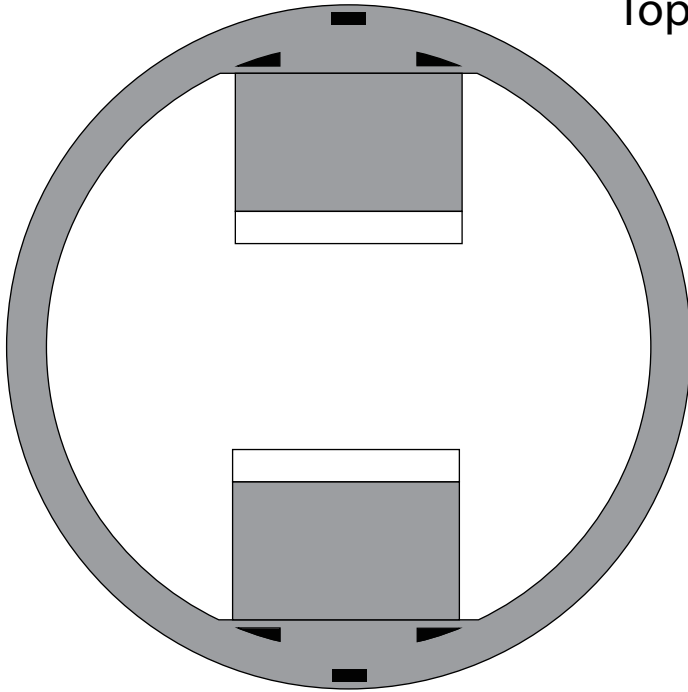

Bottom ring

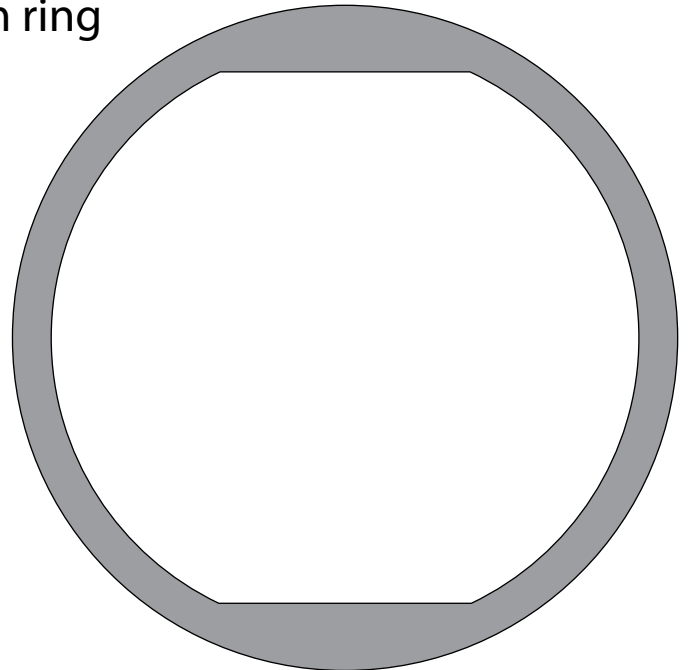
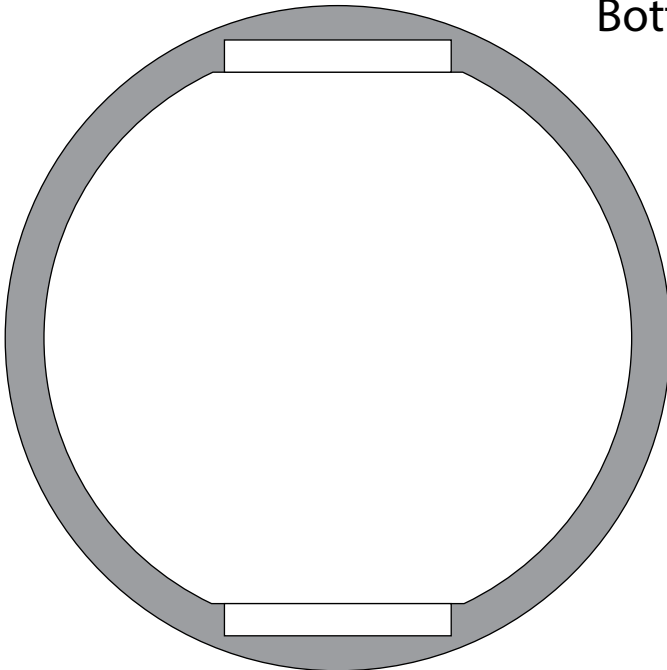



1 cm

1 inch

1:100 Scale

Starship BN-3 Upper Dome

Print on Cardstock (110 lbs)

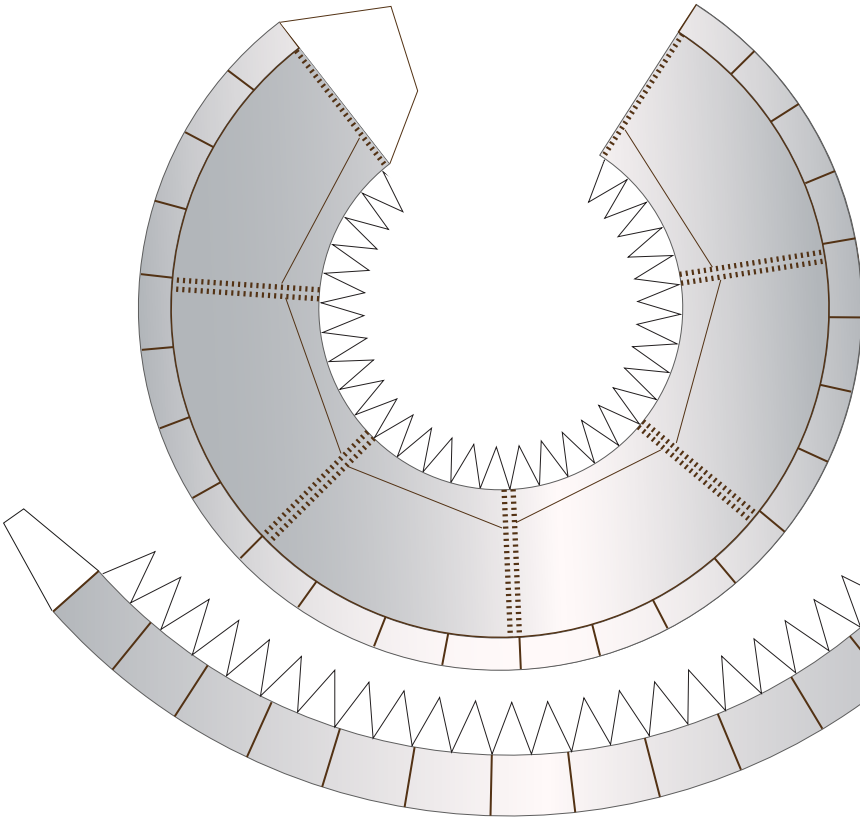
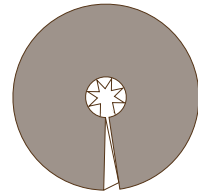
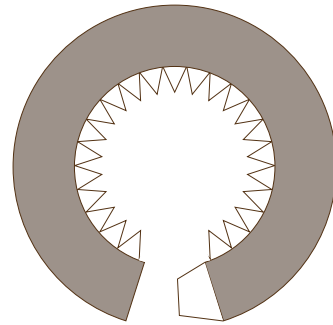
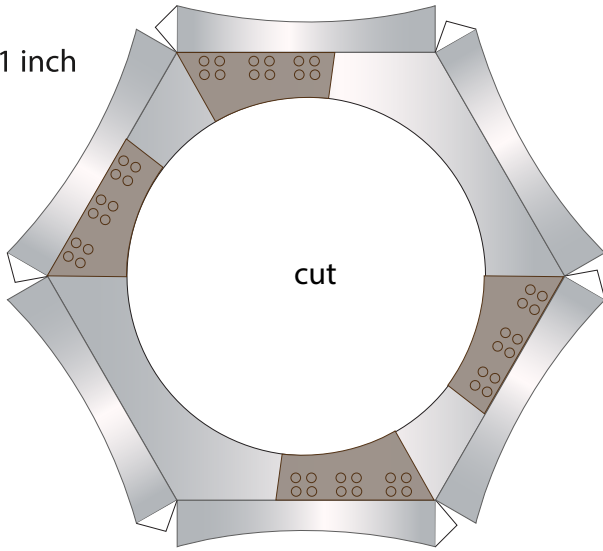

Diagram

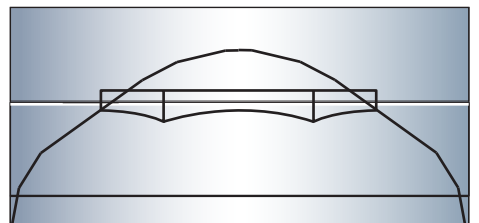



1:100 Scale



SpaceX Starship BN-3

Print on Cardstock (110 lbs)

Connectors for each body segment

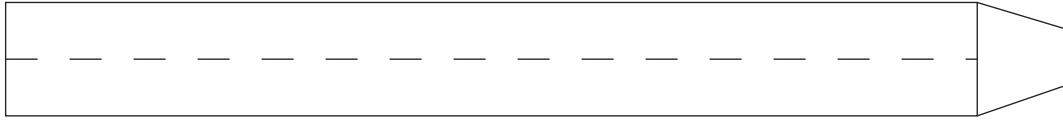
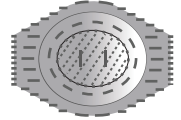

top/middle

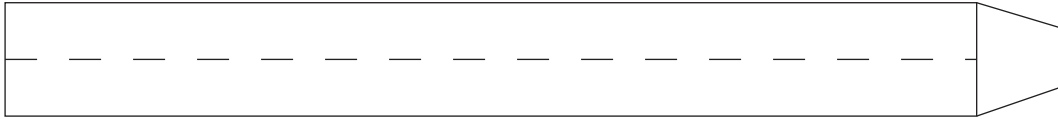

middle/bottom

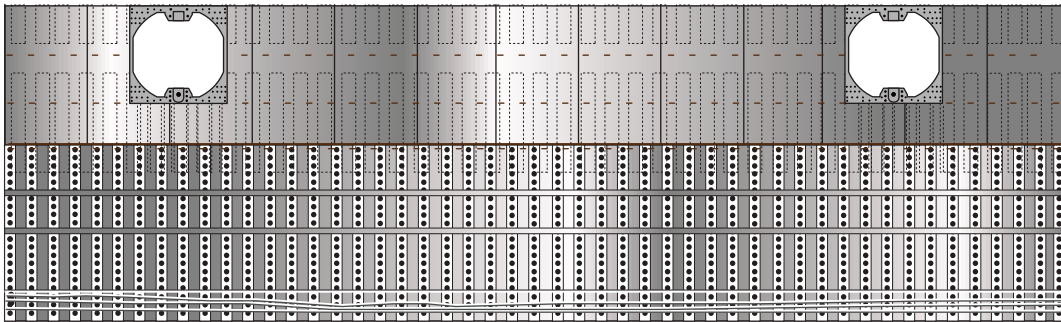

Interior wall
for upper dome
section

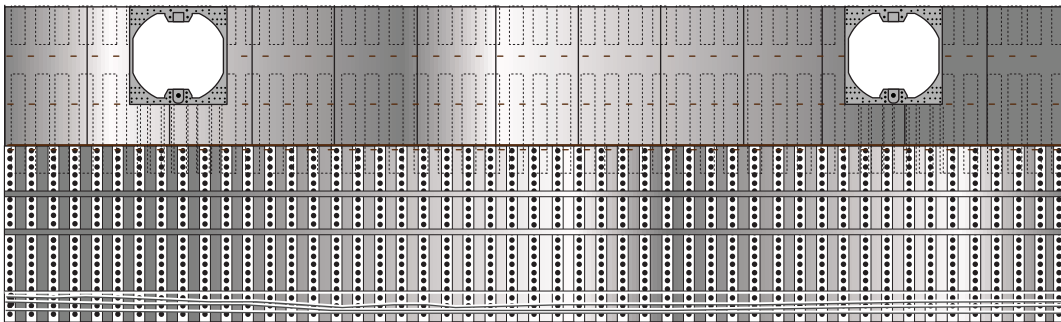



1:100 Scale

1 cm

1 inch

SpaceX BN3

Print on Cardstock (110 lbs)

Belly side top

back



front

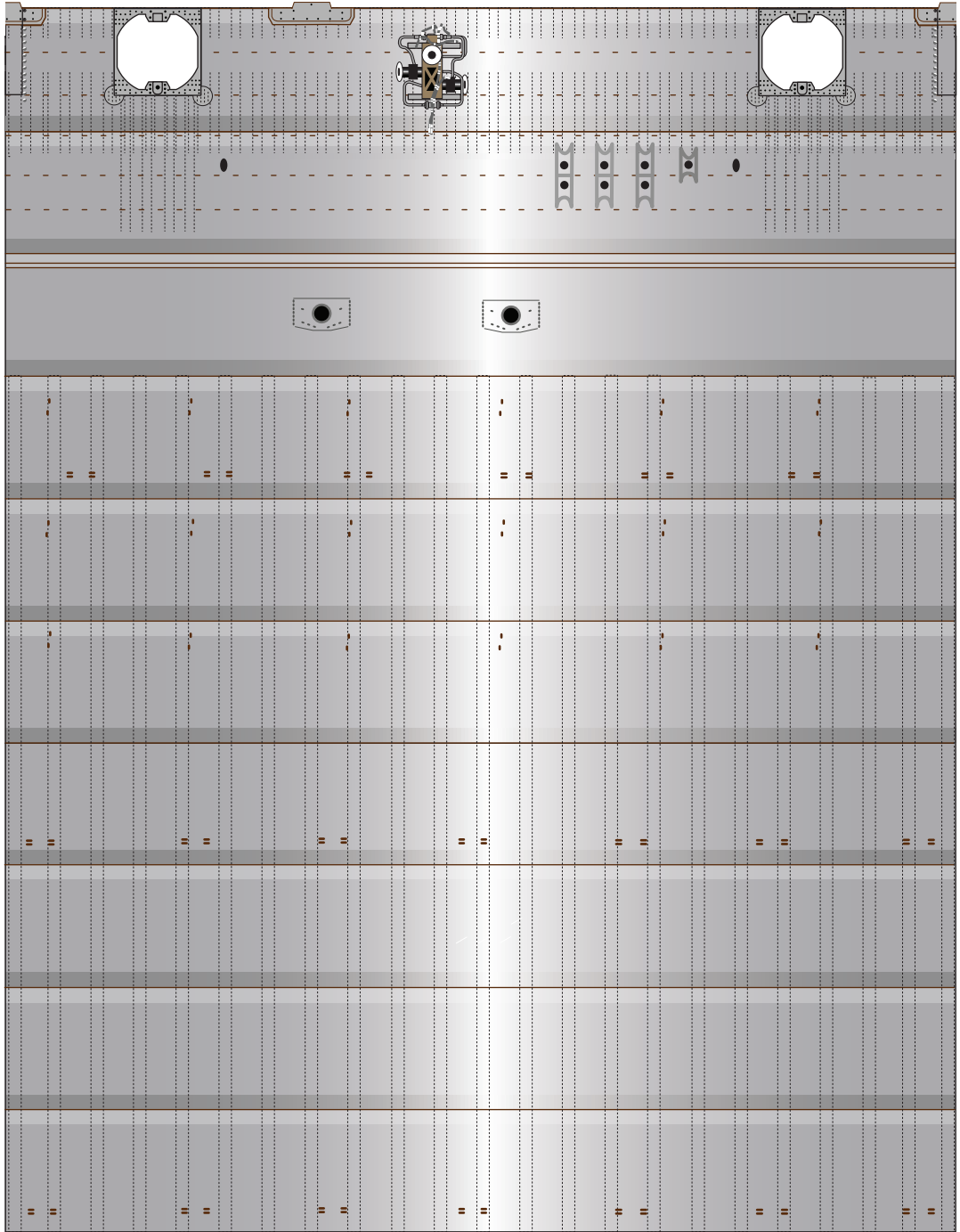
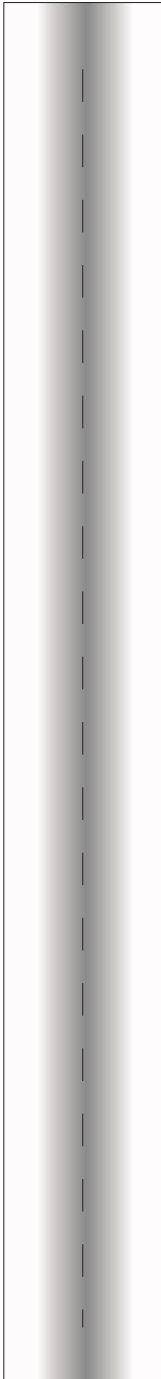
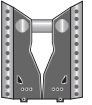
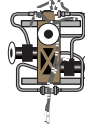
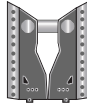



1:100 Scale



SpaceX BN3

Print on Cardstock (110 lbs)

Back side top

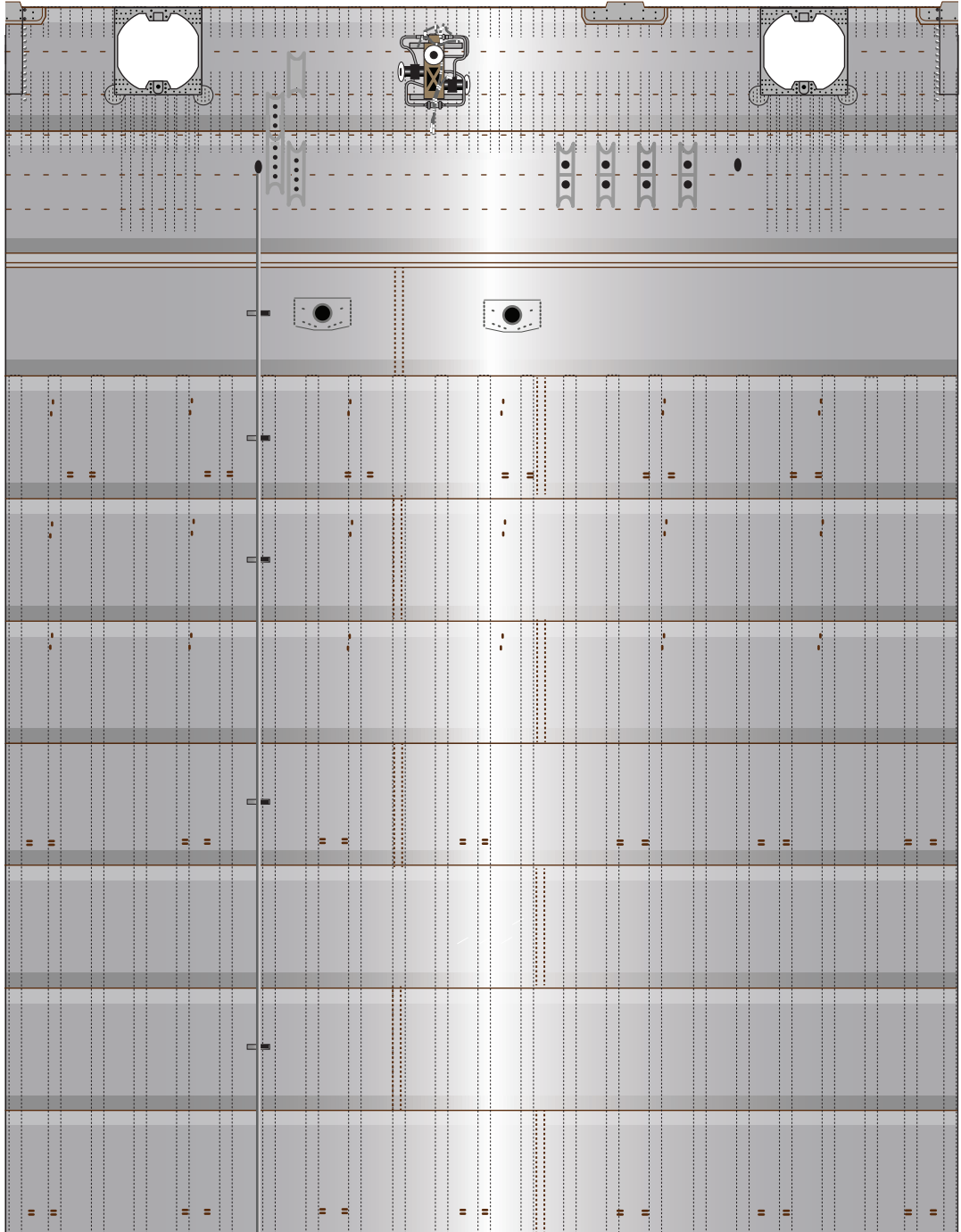
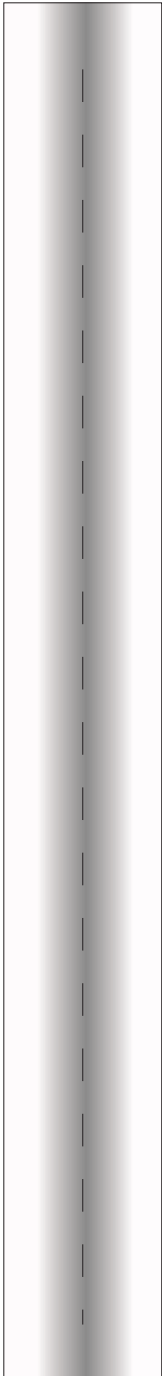
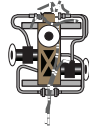



1 cm

1 inch

1:100 Scale

SpaceX BN3

Print on Cardstock (110 lbs)
Belly side middle

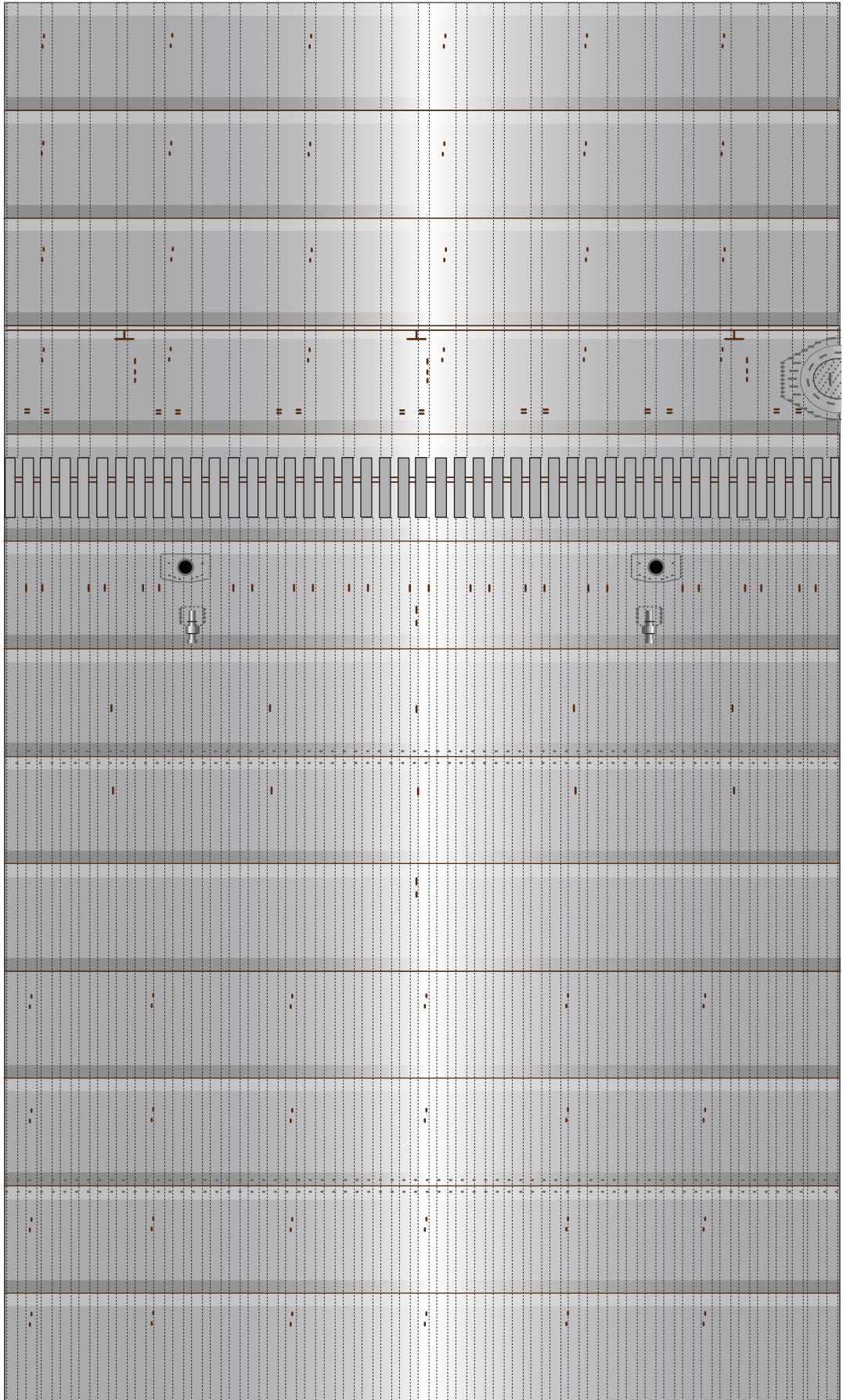



1 cm

SpaceX BN3

Print on Cardstock (110 lbs)
Back side middle

1:100

inch

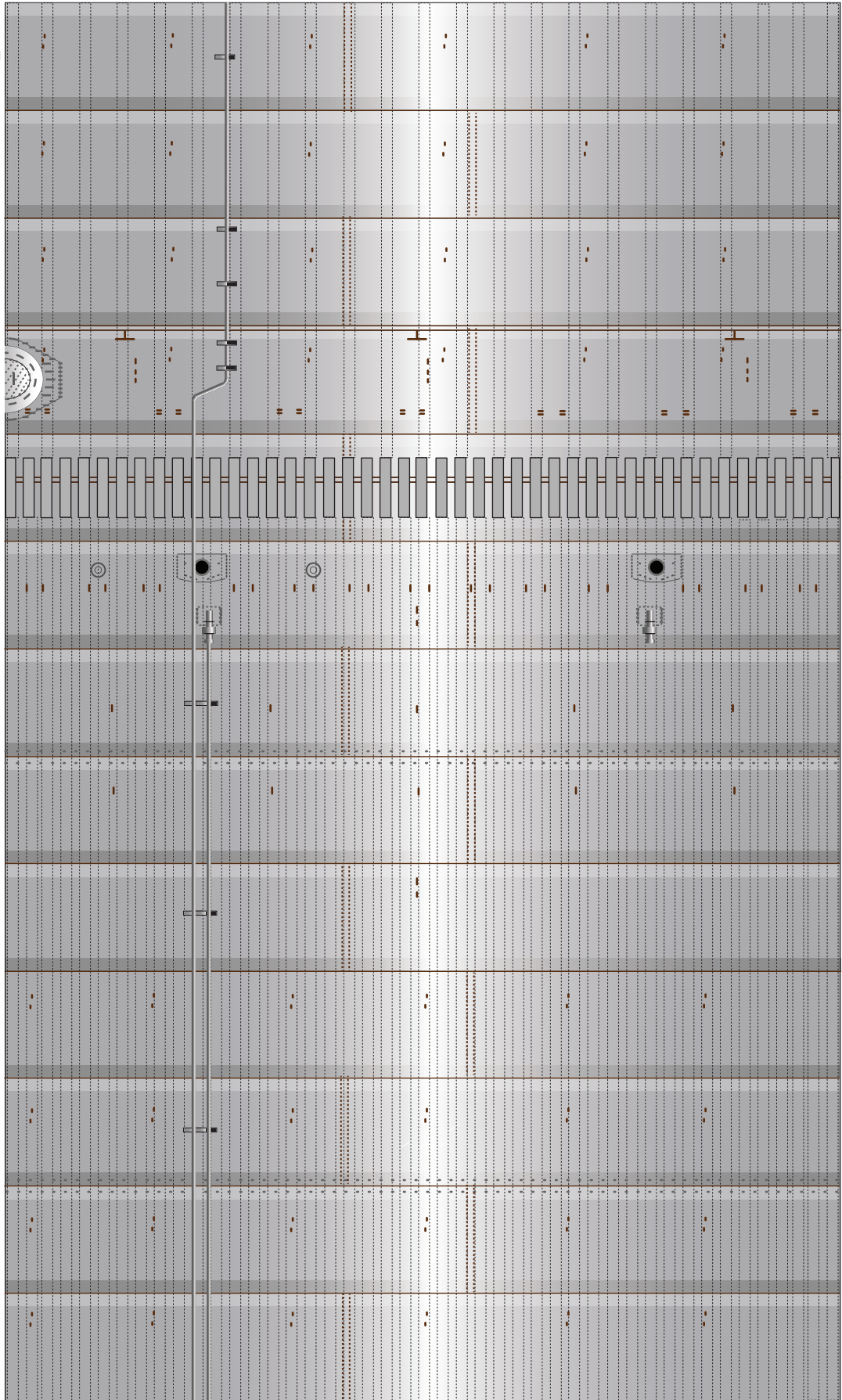



1:100 Scale

1 cm

1 inch

SpaceX BN3

Print on Cardstock (110 lbs)

Belly side bottom

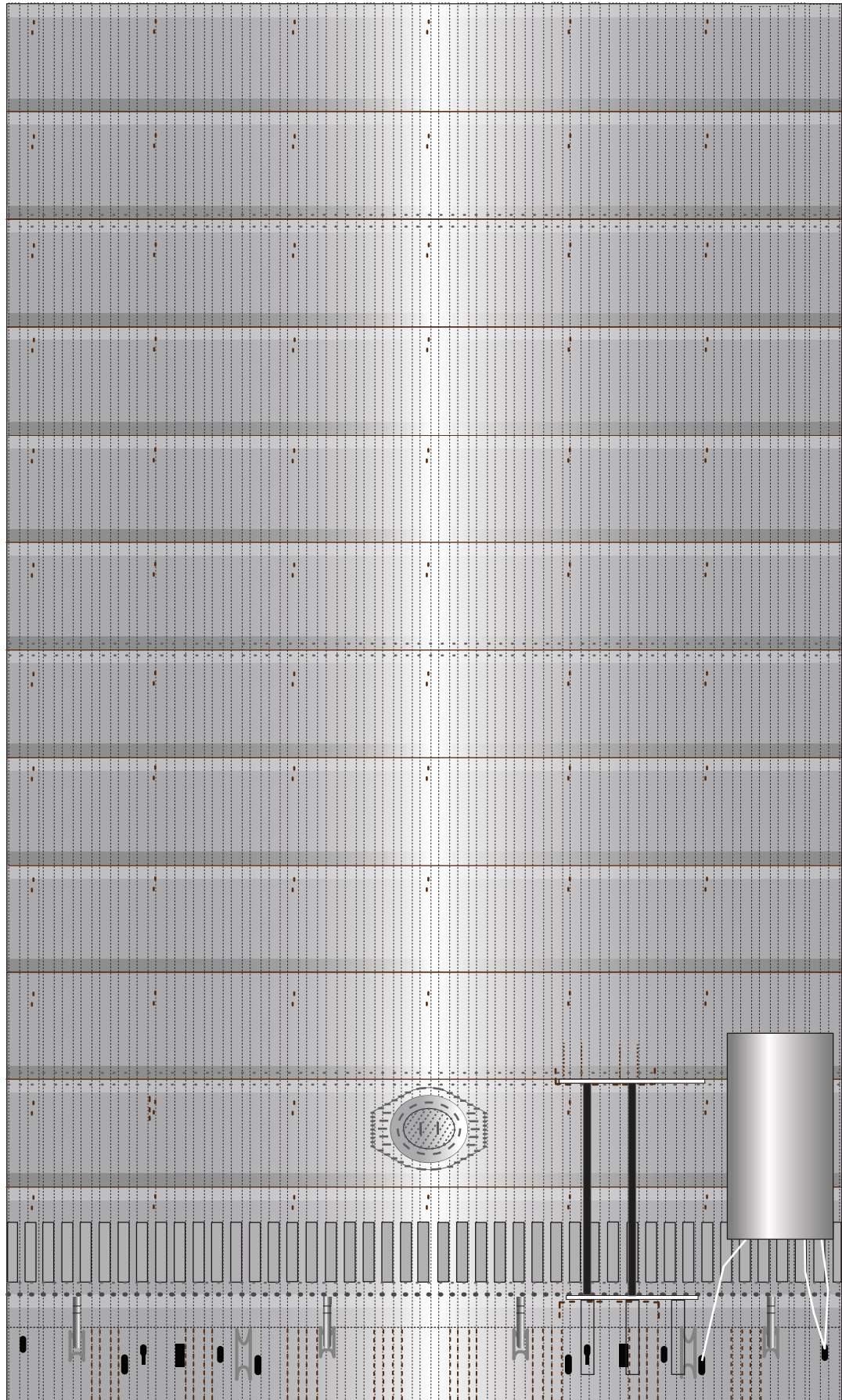



1:100 Scale

1 cm

1 inch

SpaceX BN3

Print on Cardstock (110 lbs)
Back side bottom

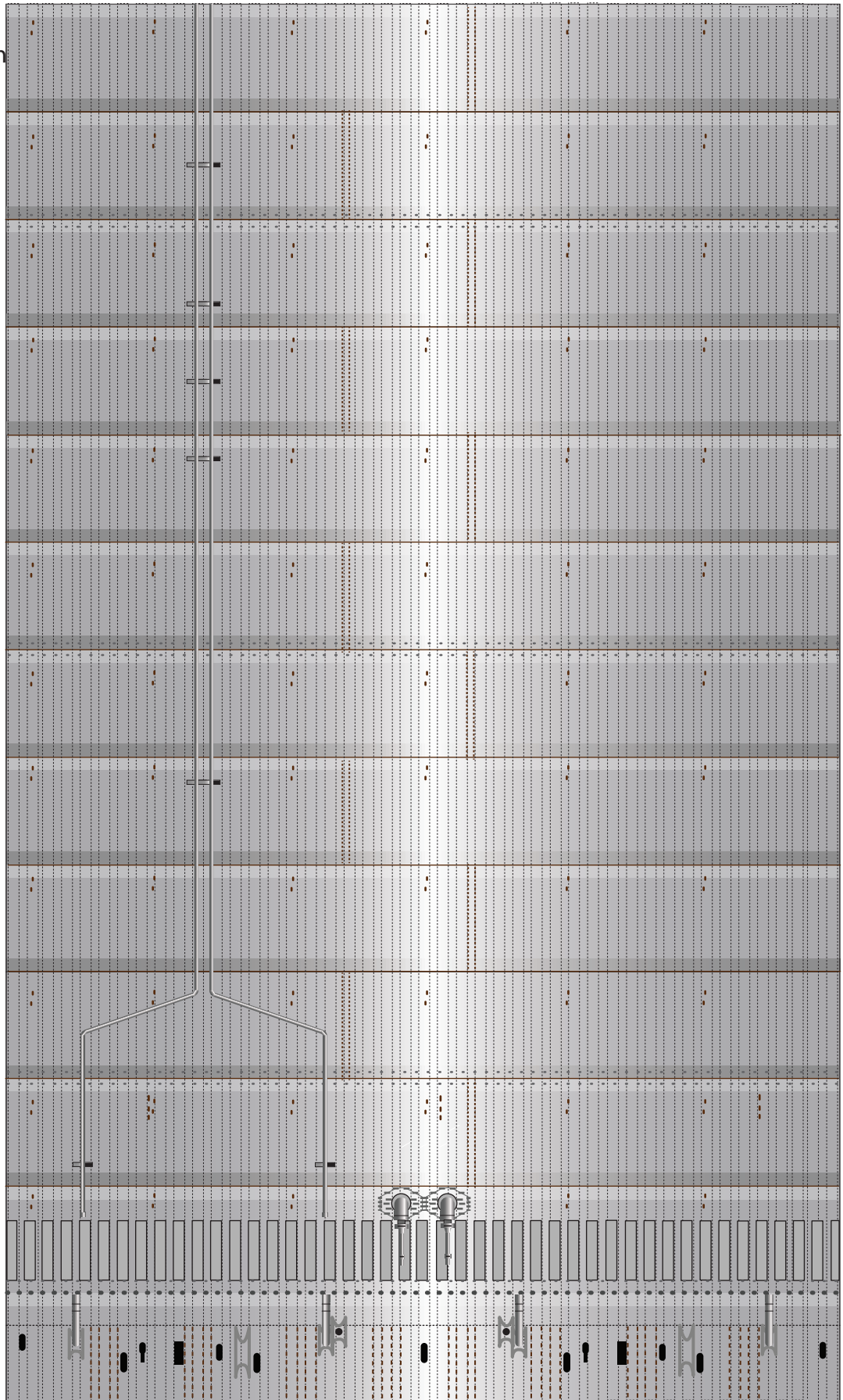



1 cm

1 inch

1:100 Scale

SpaceX BN3

Print on Cardstock (110 lbs)

COPVs

Upper dome
COPVs

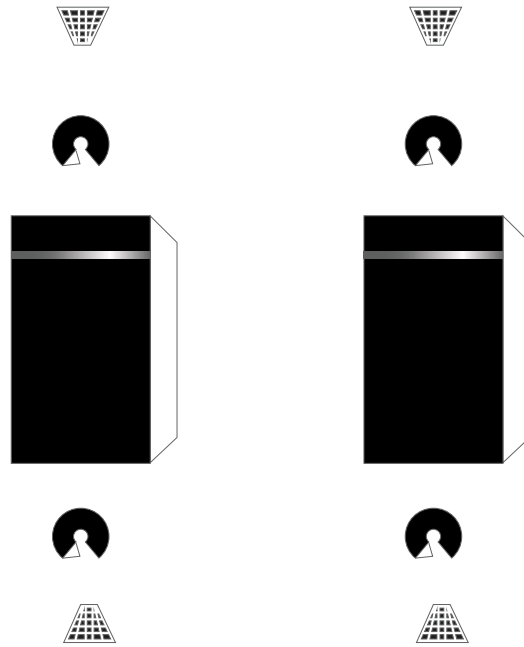

External
COPVs

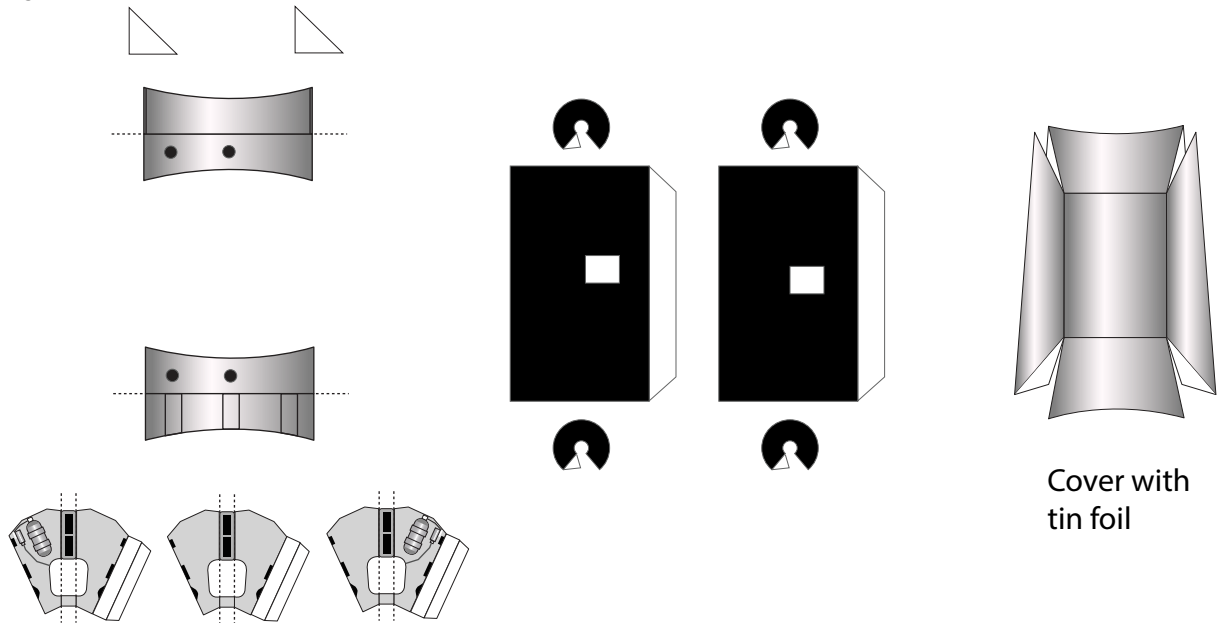

Cover with
tin foil



1:100 Scale



SpaceX Starship BN-3

Print on Cardstock (110 lbs)

Formers for top section

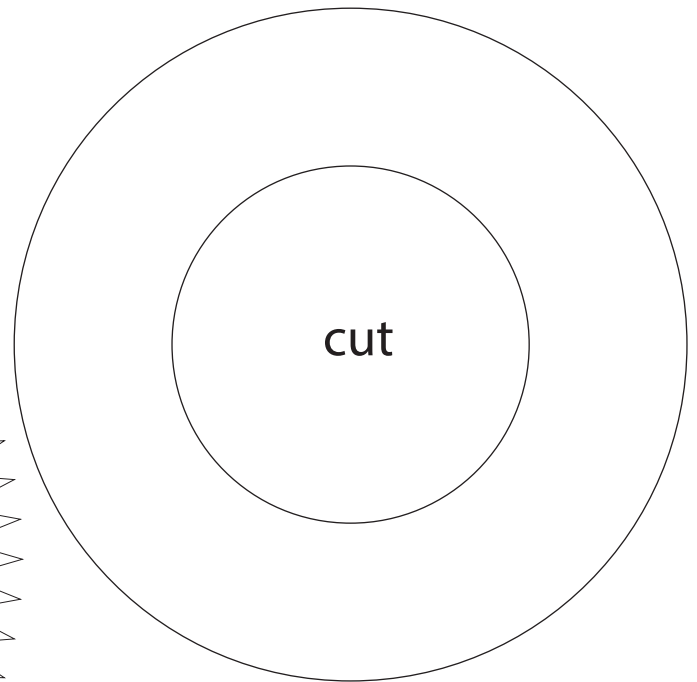
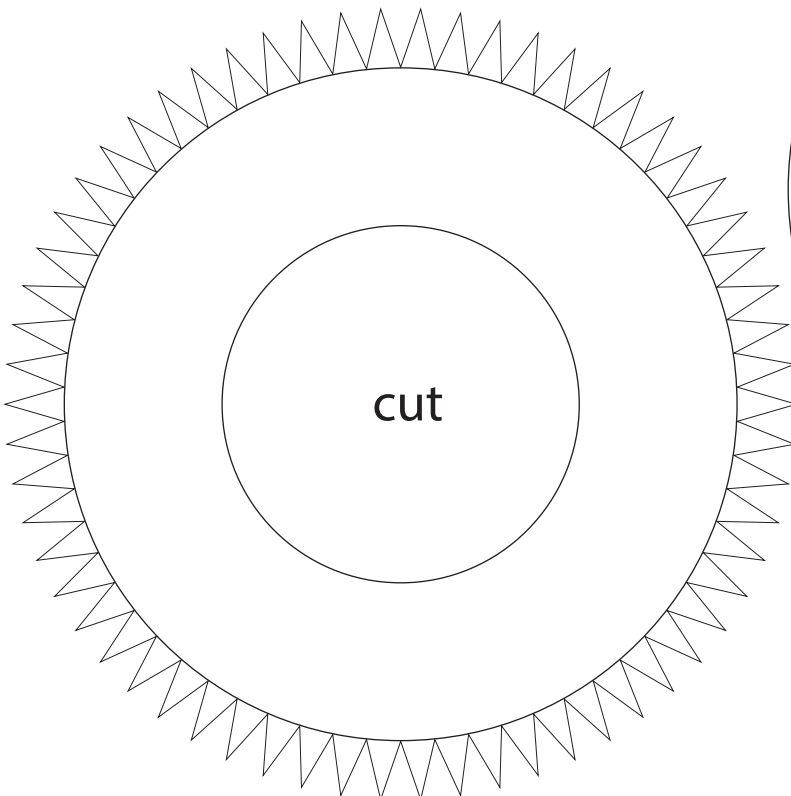
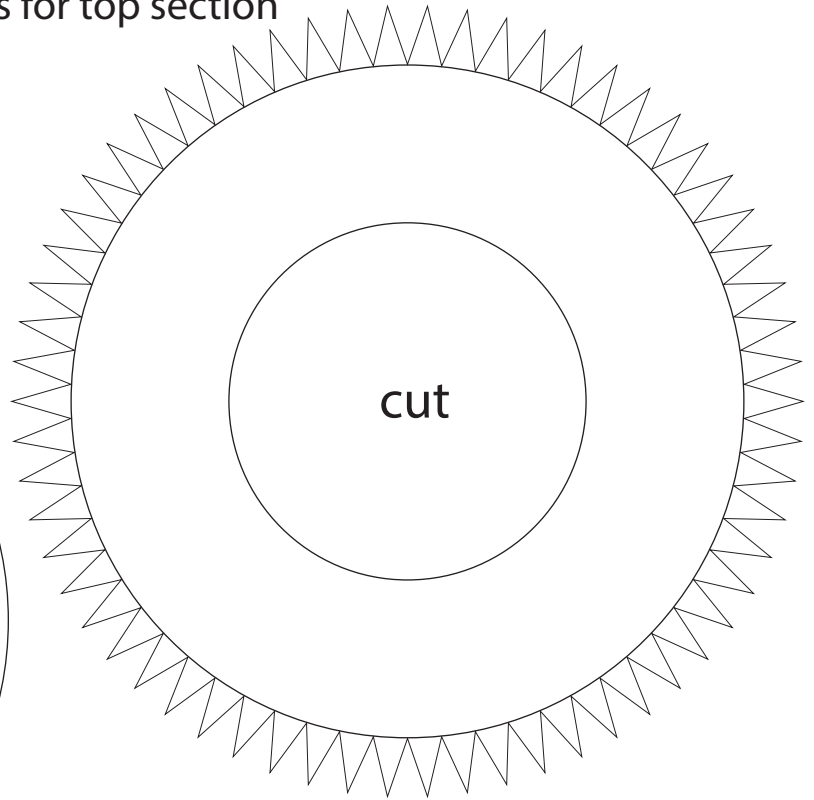
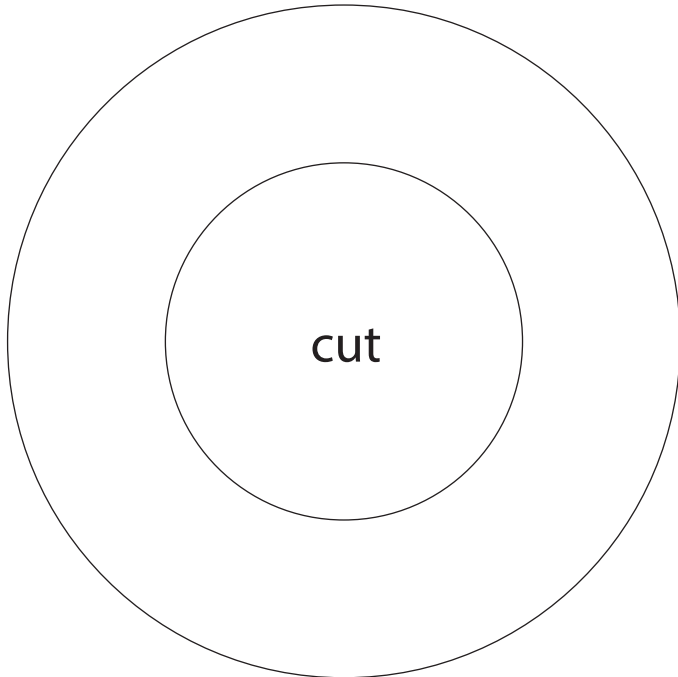

IMPORTANT
Top former is glued 42 mm from top edge of top booster section.
Bottom former is glued 20 mm from bottom edge of top booster section.



1:100 Scale



SpaceX Starship BN-3

Print on Cardstock (110 lbs)

Formers for middle body

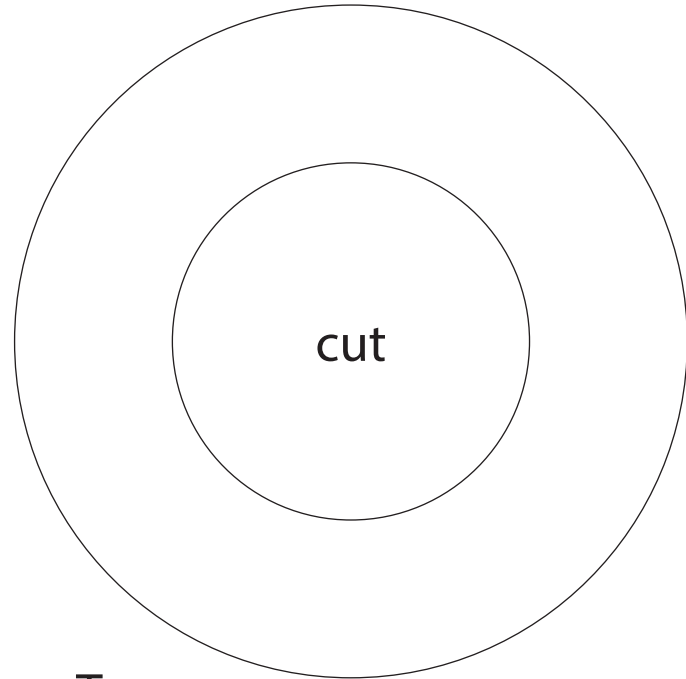

Top

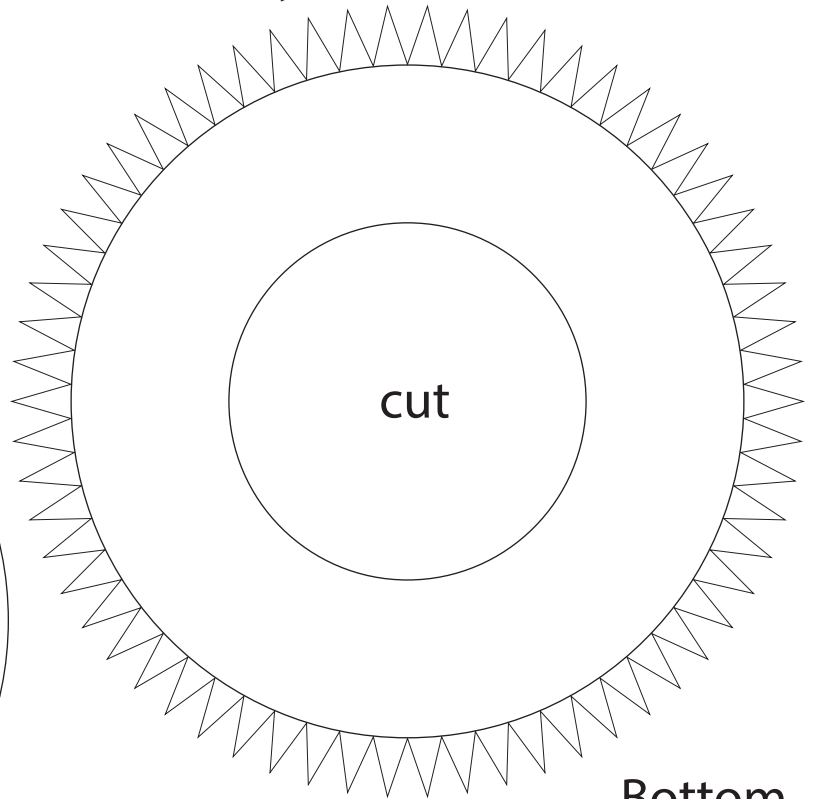

Bottom

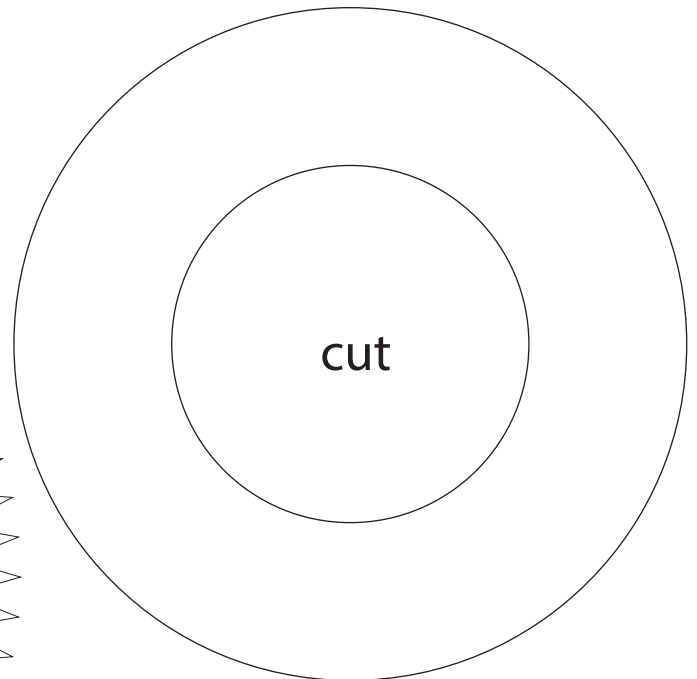
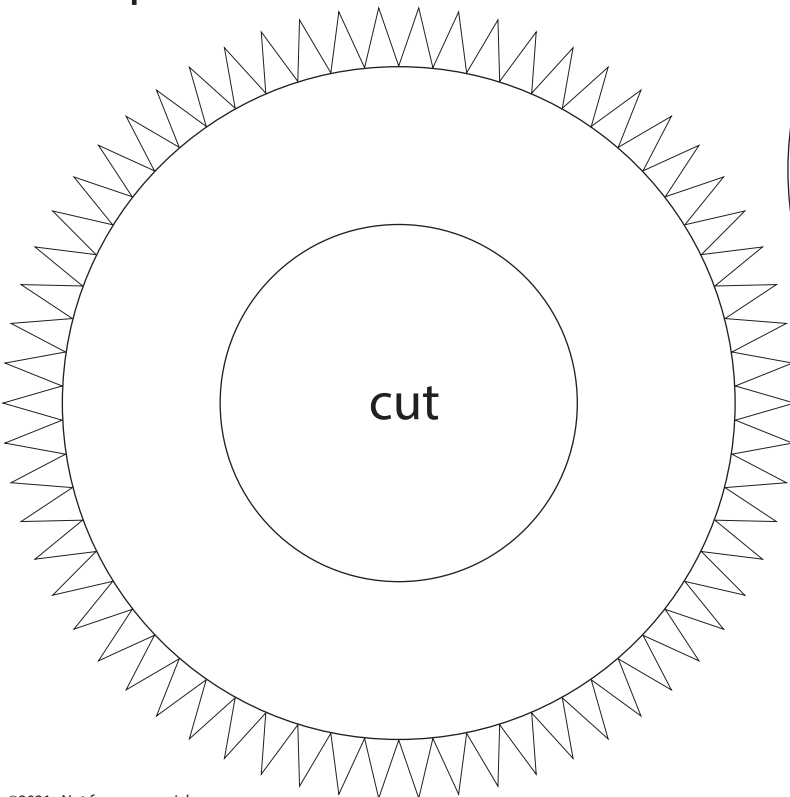

IMPORTANT

Top former is glued 20 mm from top edge of middle booster section. Bottom former is glued 20 mm from bottom edge of middle booster section.



1:100 Scale



SpaceX Starship BN-3

Print on Cardstock (110 lbs)

Formers for bottom body

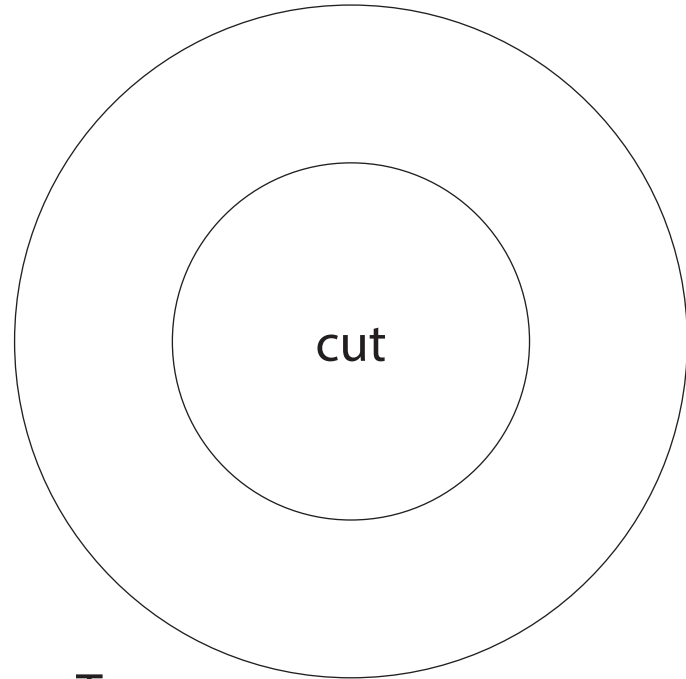

Top

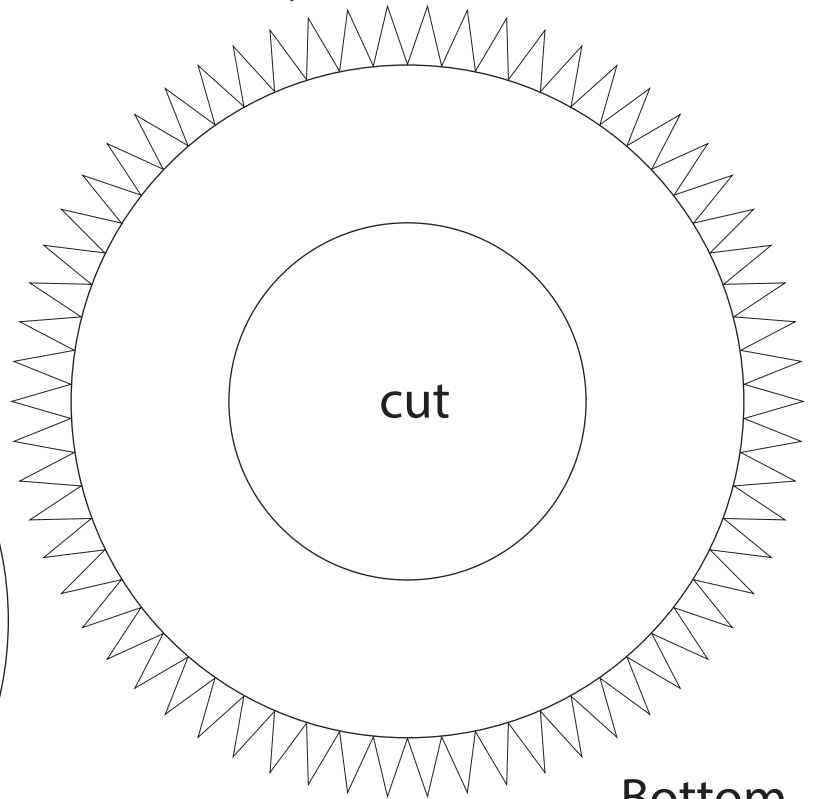

Bottom

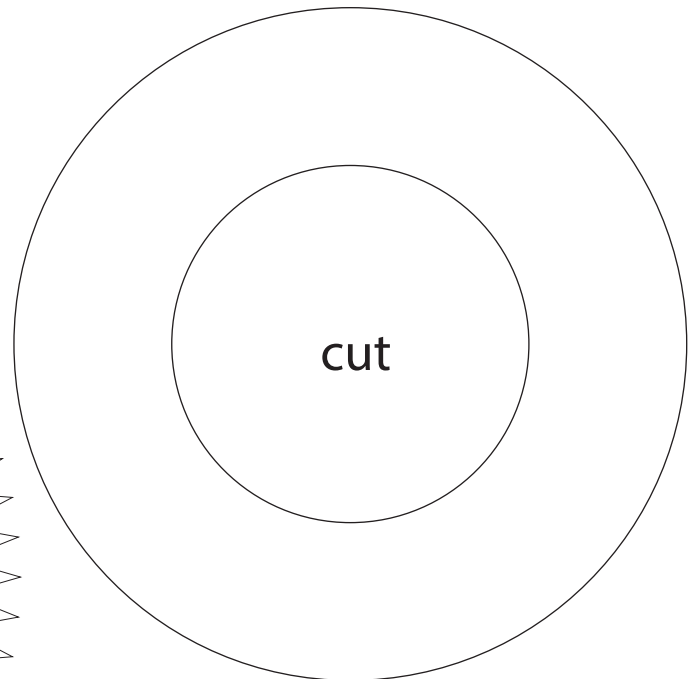
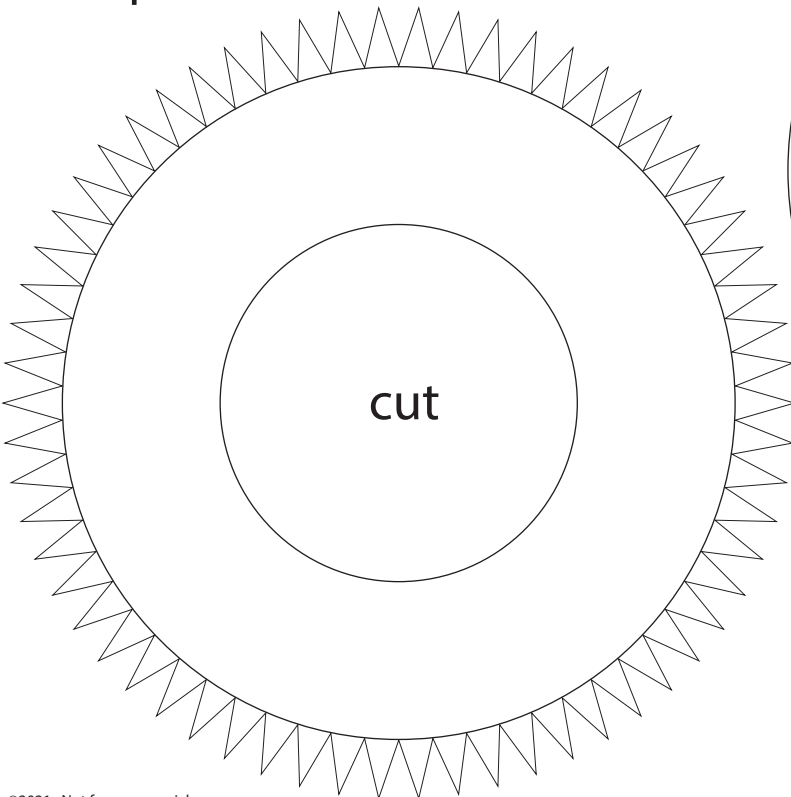

IMPORTANT

Top former is glued 20 mm from top edge of bottom booster section.
Bottom former is glued 19 mm from bottom edge of bottom booster section.



1 cm

1 inch

1:100 Scale

SuperHeavy Bulkhead

Print on Cardstock (110 lbs)

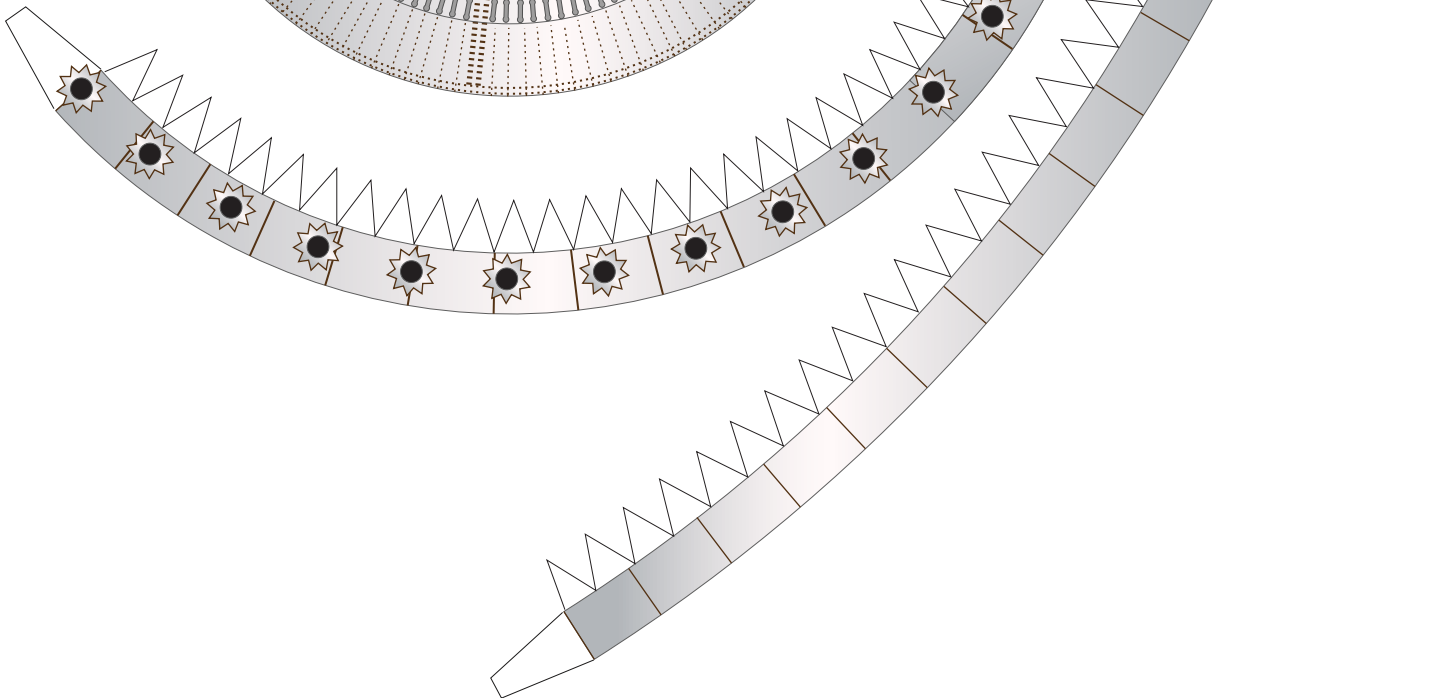
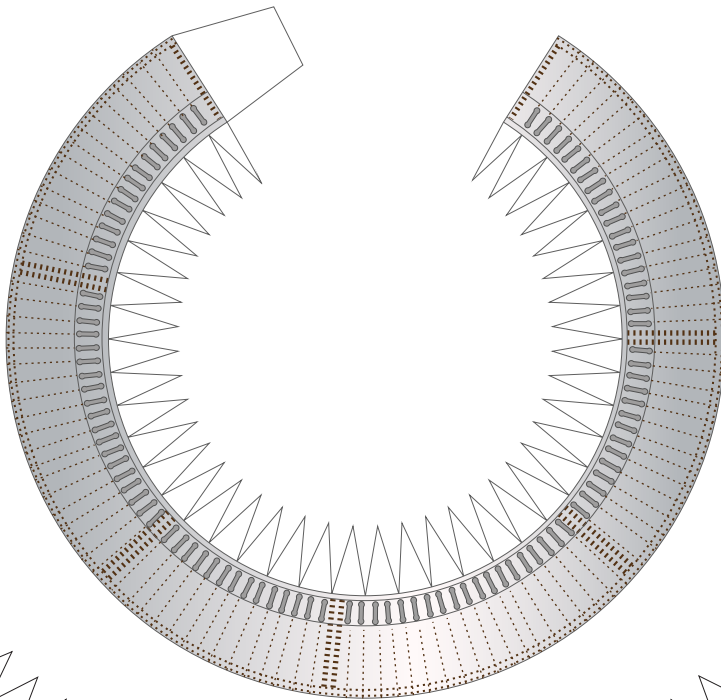
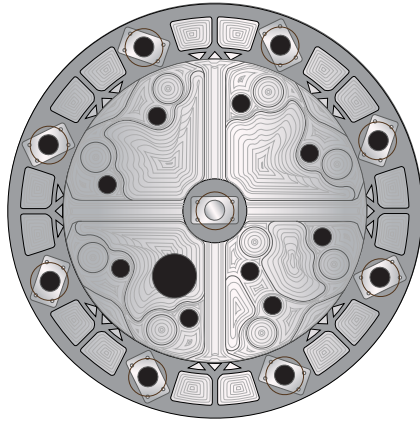



1 cm

1 inch

1:100 Scale

SpaceX SuperHeavy

Print on Cardstock (110 lbs)

Outer Raptor ring

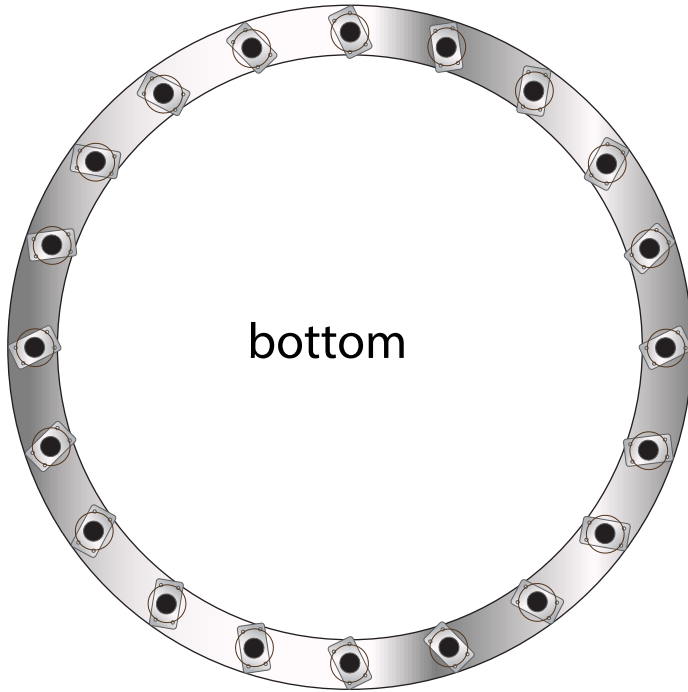

bottom

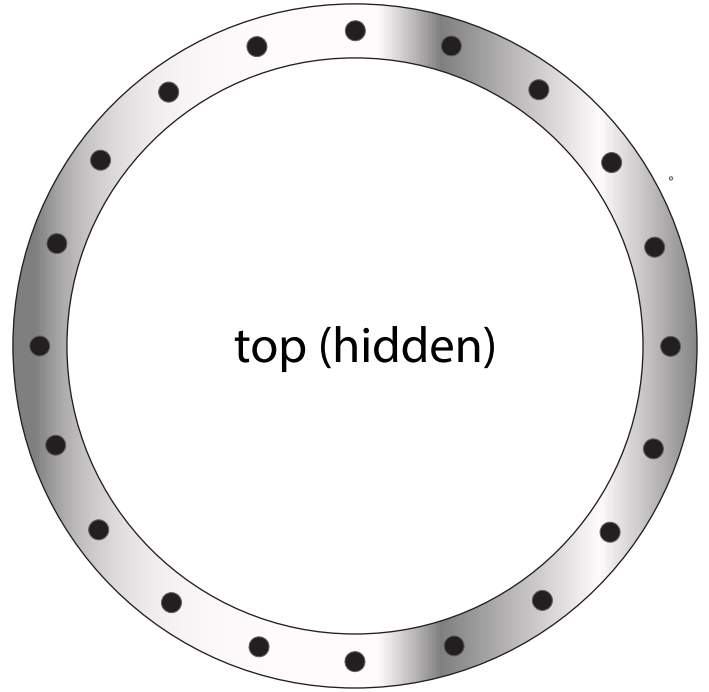

top (hidden)

Engine section interior skin

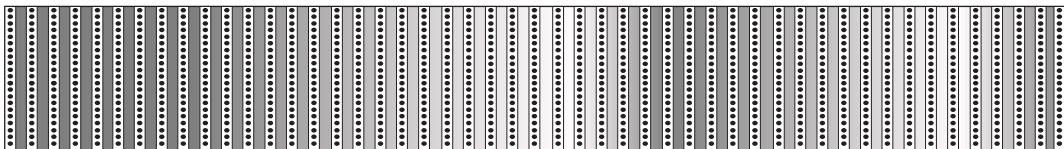
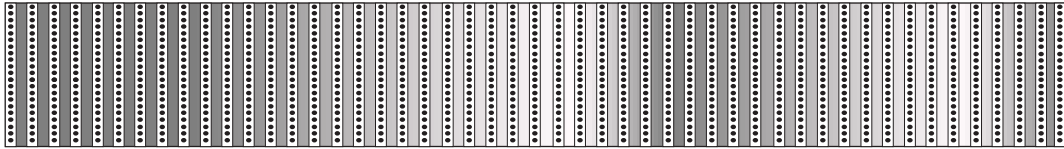



1 cm

1 inch

1:100 Scale

BN3 Raptors

Print on cardstock (110 lbs)

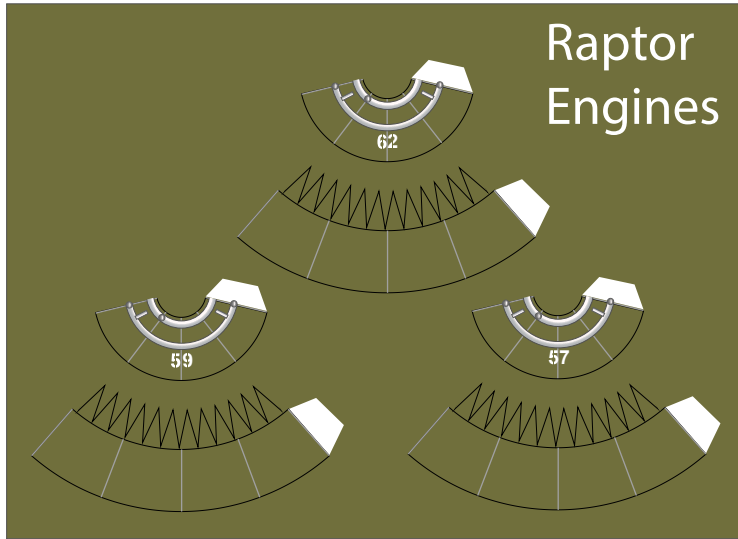

Raptor Engines

