

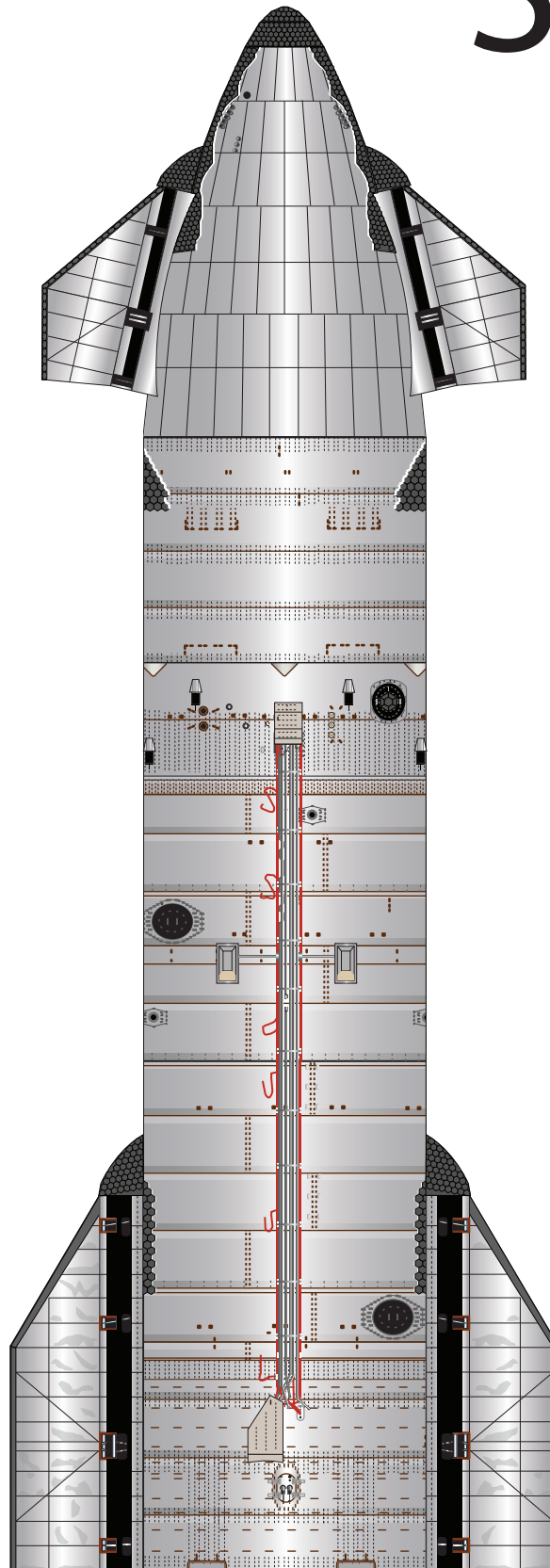

SN-20

1:100 Scale

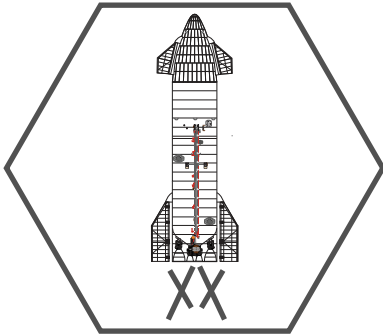

S
T
A
R
S
H
I
P



SpaceX Starship SN 20

Print on Cardstock (110 lbs)

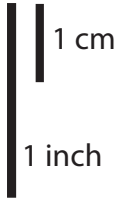

1:100 Scale

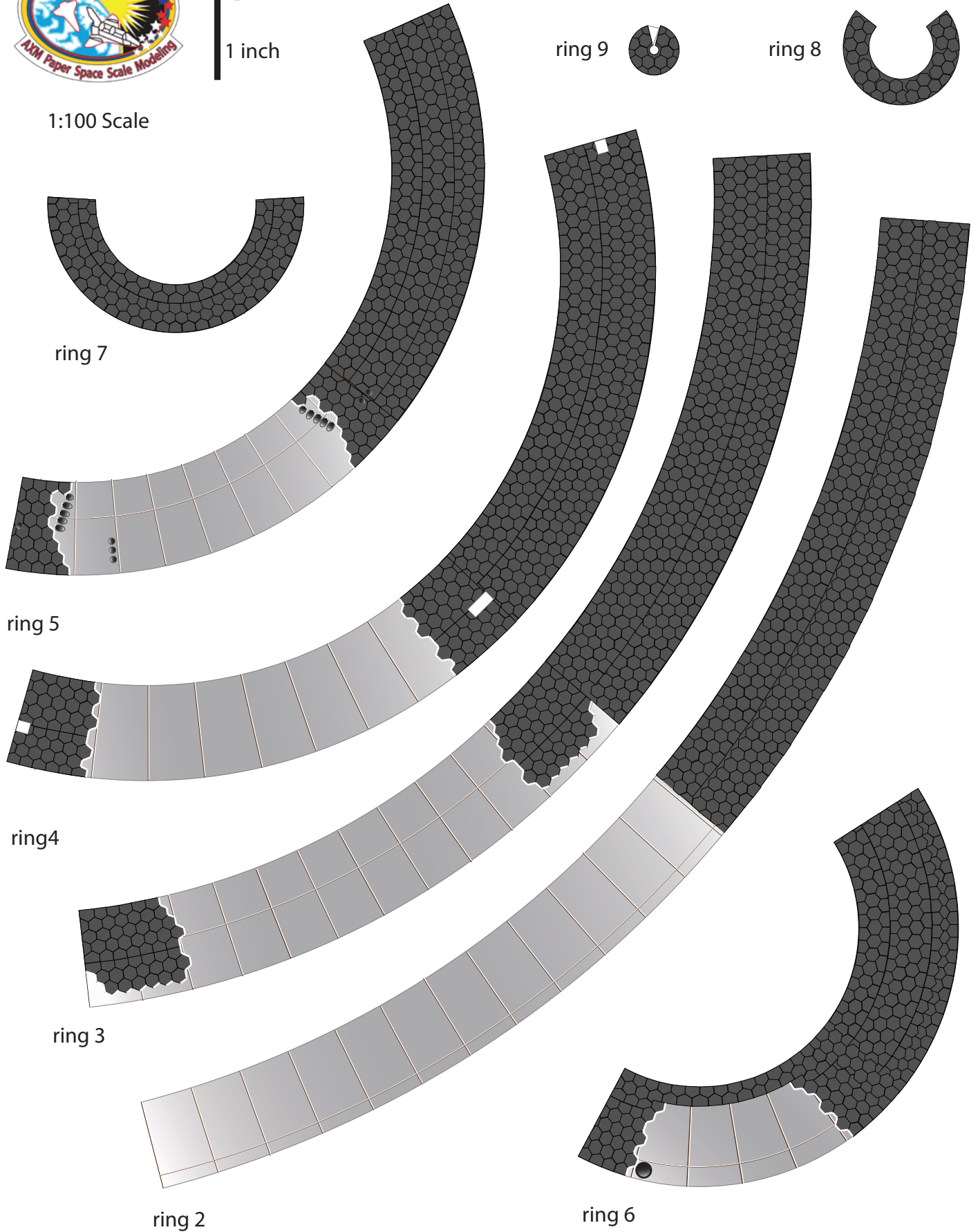



1:100 Scale

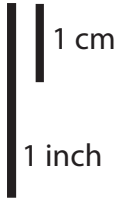

SpaceX Starship SN 20

Print on Cardstock (110 lbs)

Connectors for
nosecone



ring 1

base



1:100 Scale

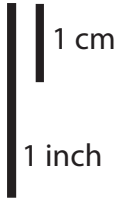

SpaceX Starship SN

Print on Cardstock (110 lbs)

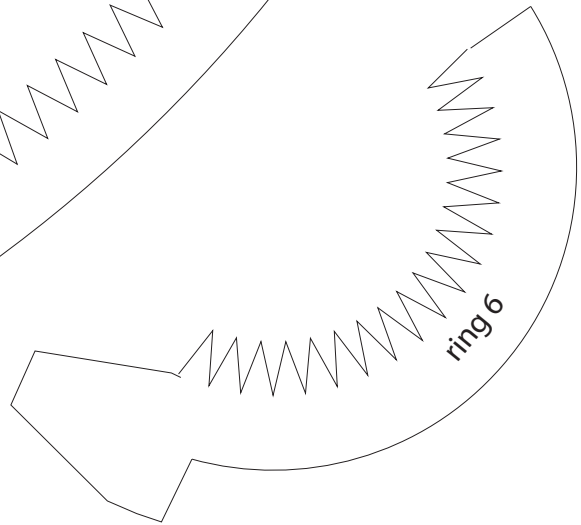
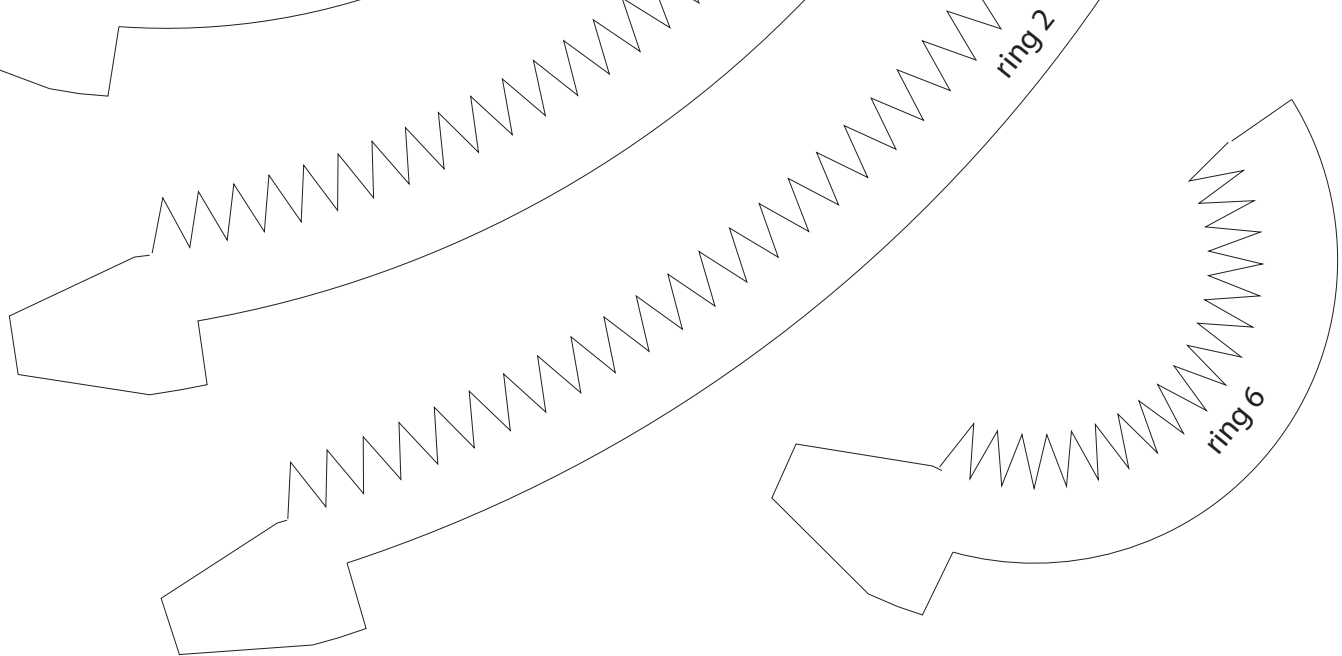
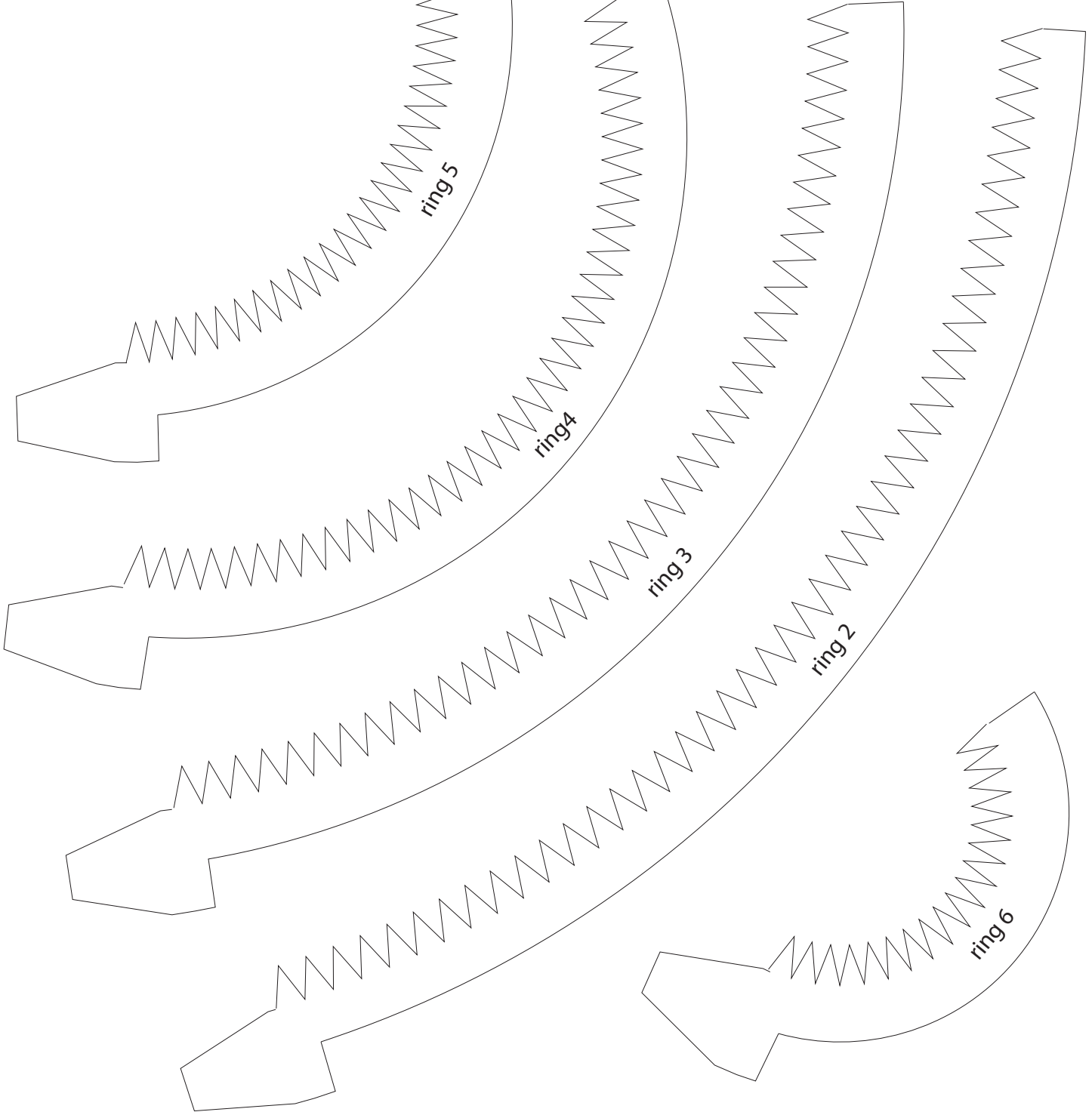
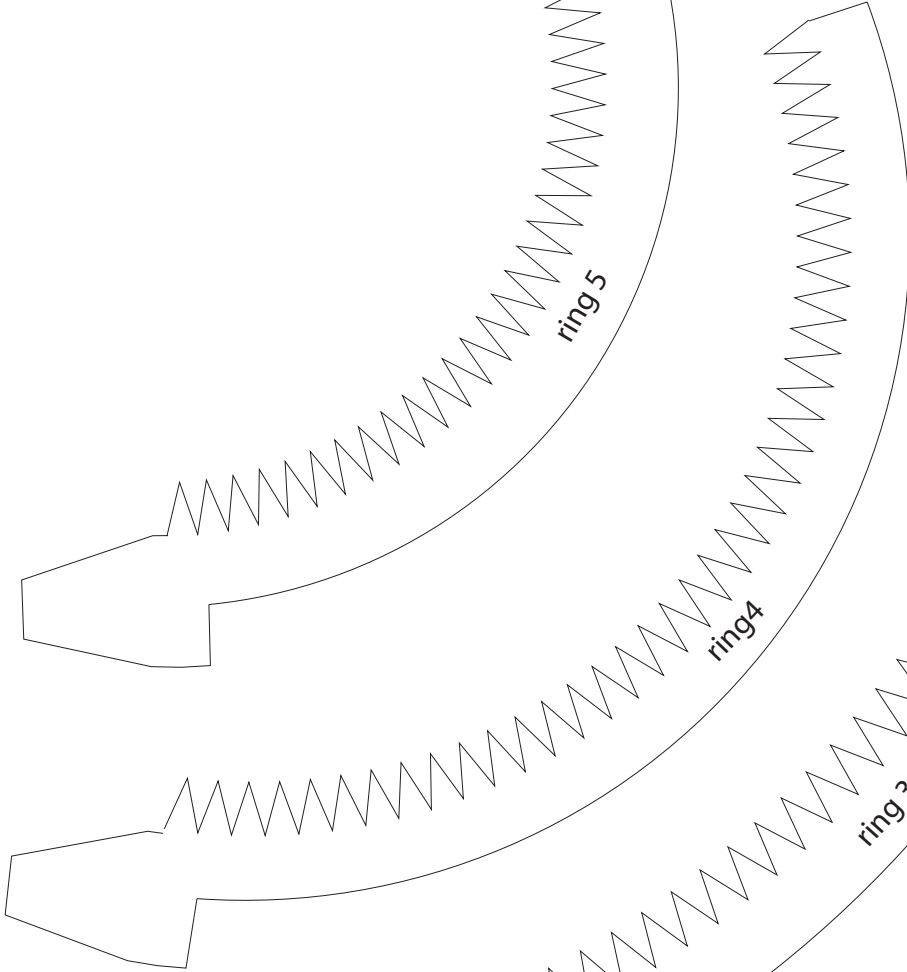
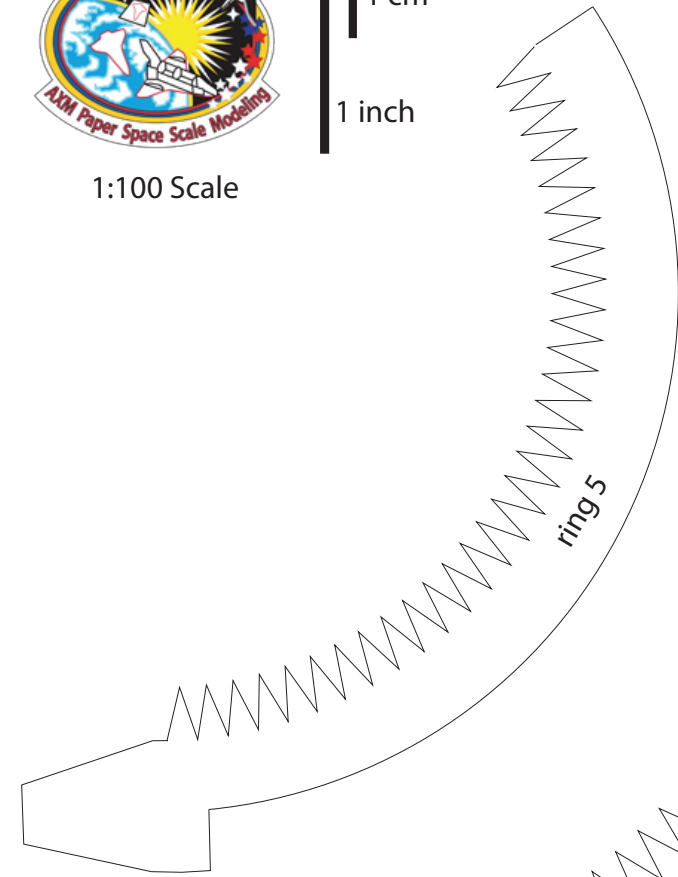
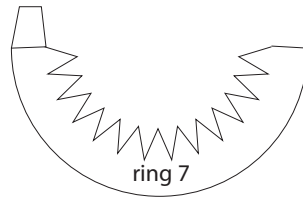



1:100 Scale

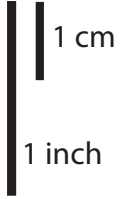

SpaceX Starship SN

Print on Cardstock (110 lbs)

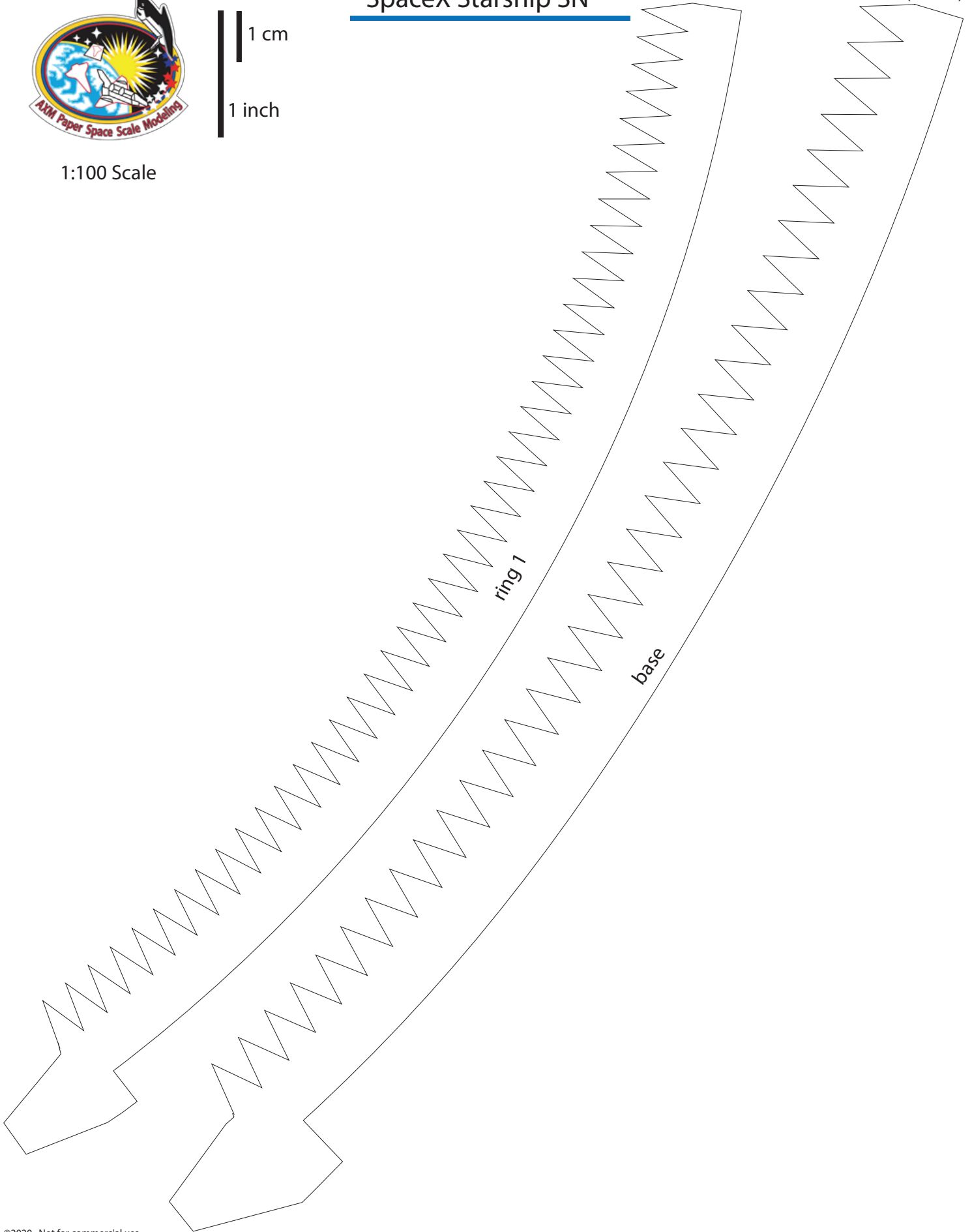



1:100 Scale

SpaceX Starship SN 20

Print on Cardstock (110 lbs)

1 cm

1 inch

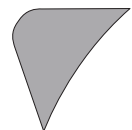
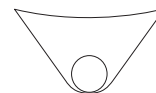
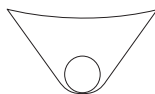
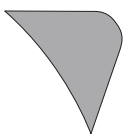
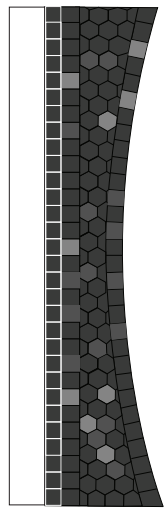
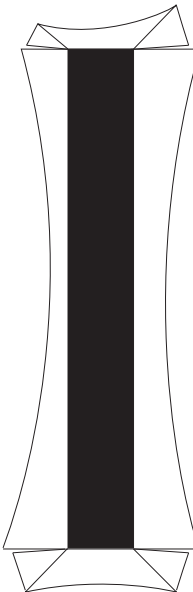
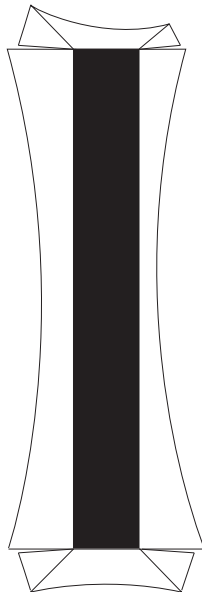
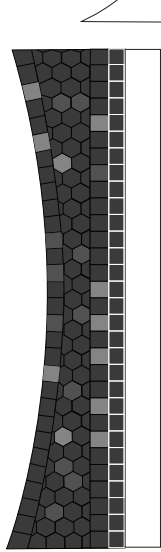
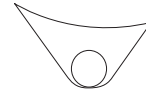
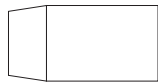
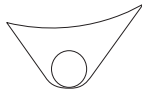
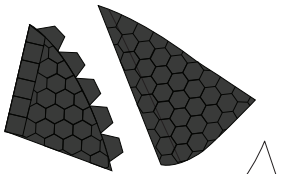
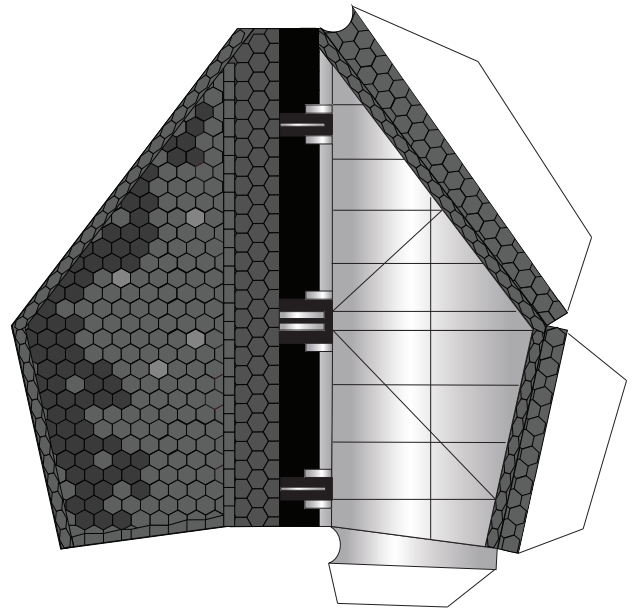
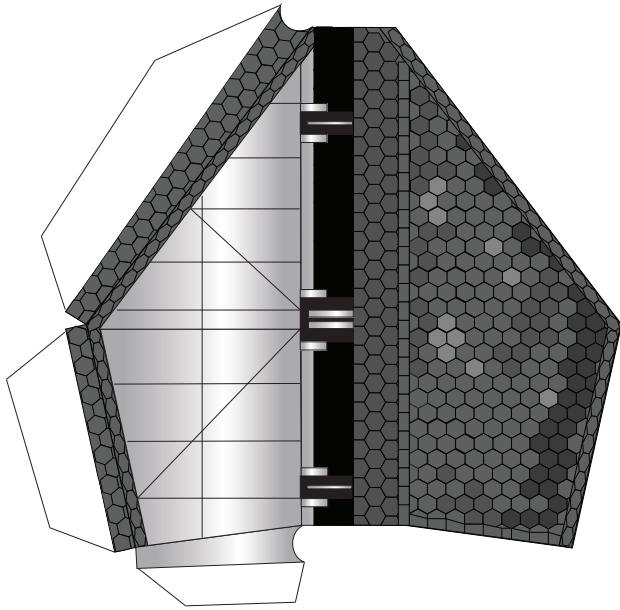



1:100 Scale



SpaceX Starship SN20

Print on Cardstock (110 lbs)

Nosecone-body 4 ring stack

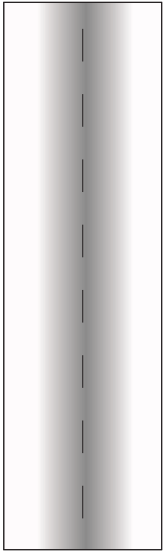

Umbilical side

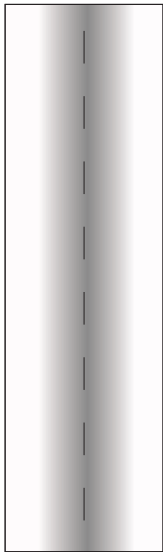
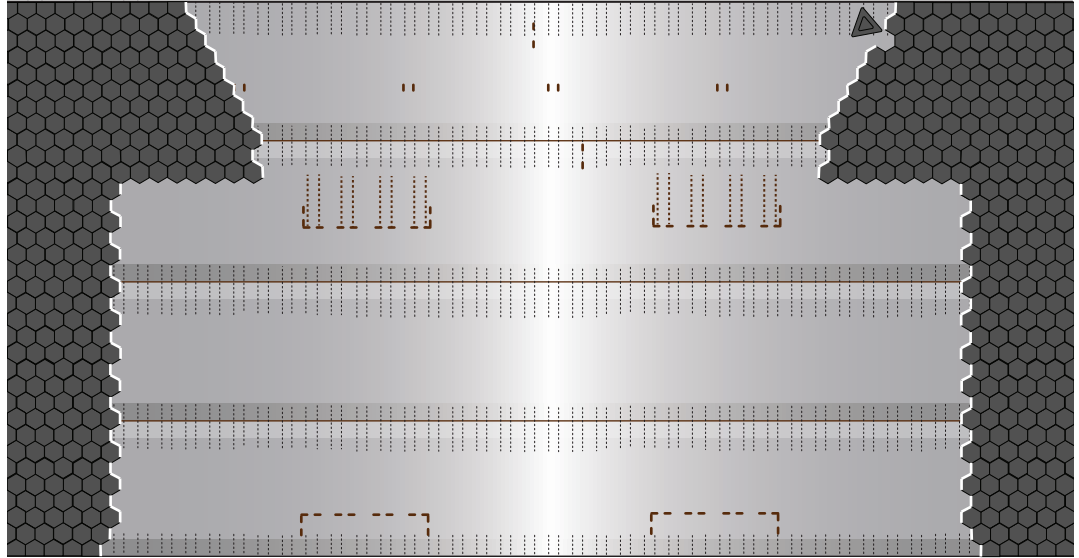

Front

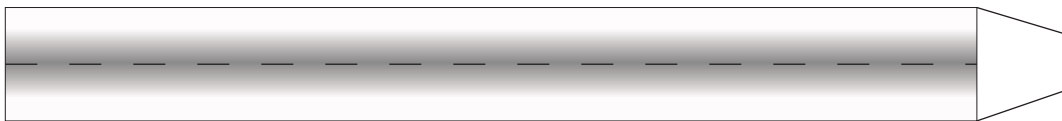
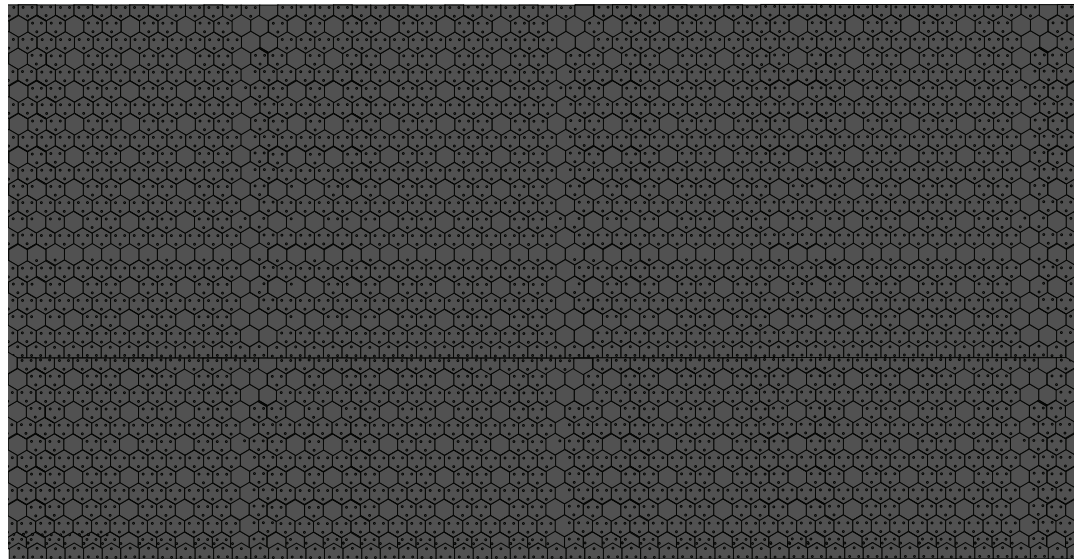

Connectors for 4 ring stack and body

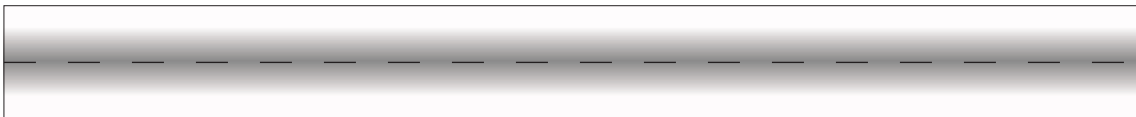



1:100 Scale

1 cm
1 inch

SpaceX Starship SN20

Print on Cardstock (110 lbs)

Back top

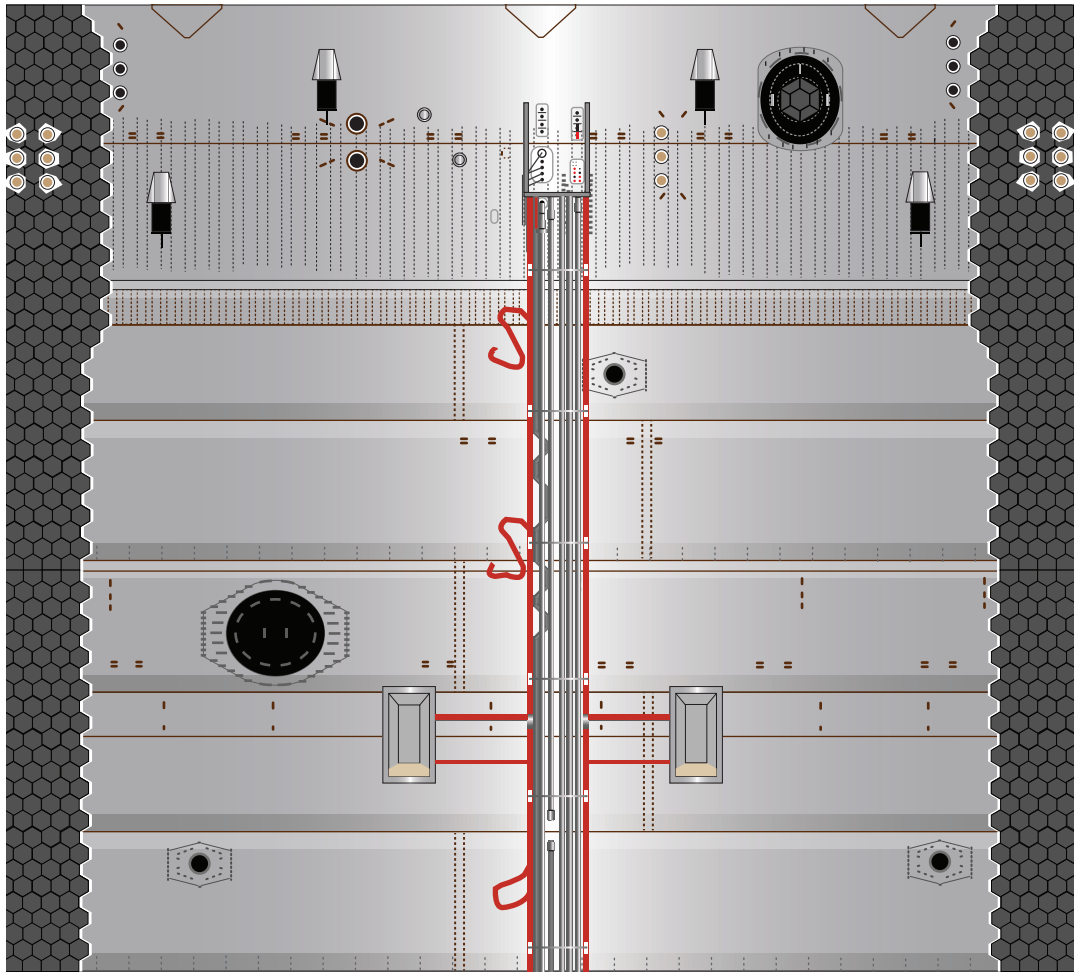
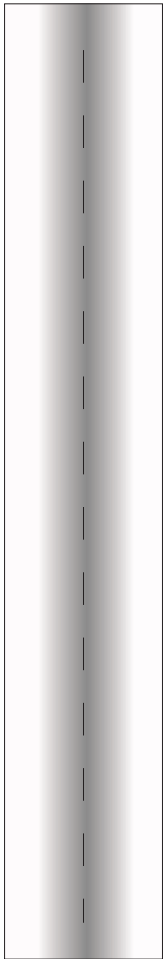
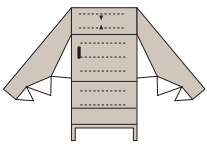
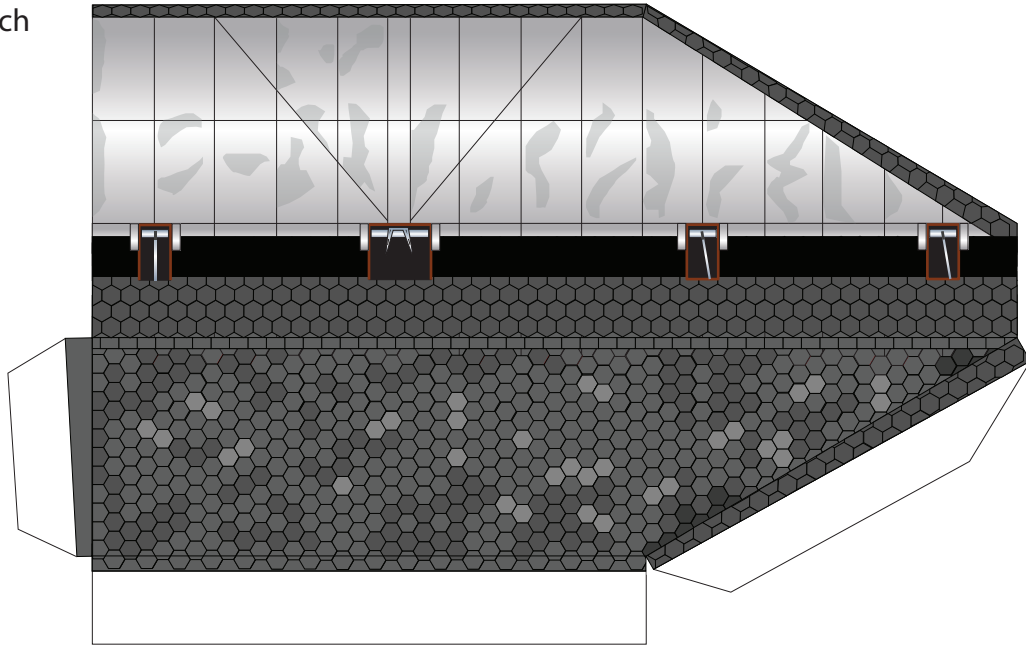



1:100 Scale

1 cm
1 inch

SpaceX Starship SN20

Print on Cardstock (110 lbs)

Belly top

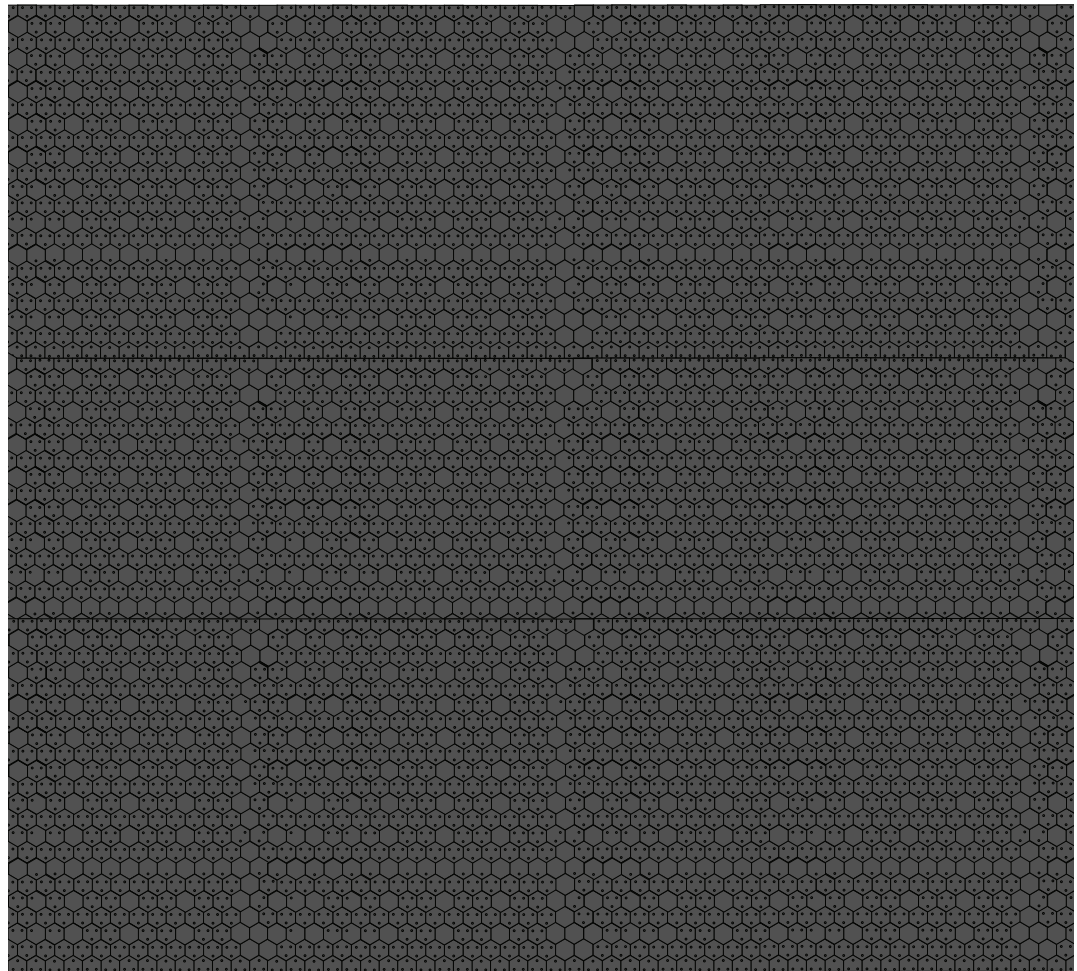
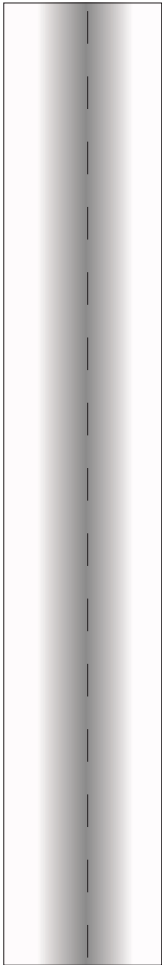
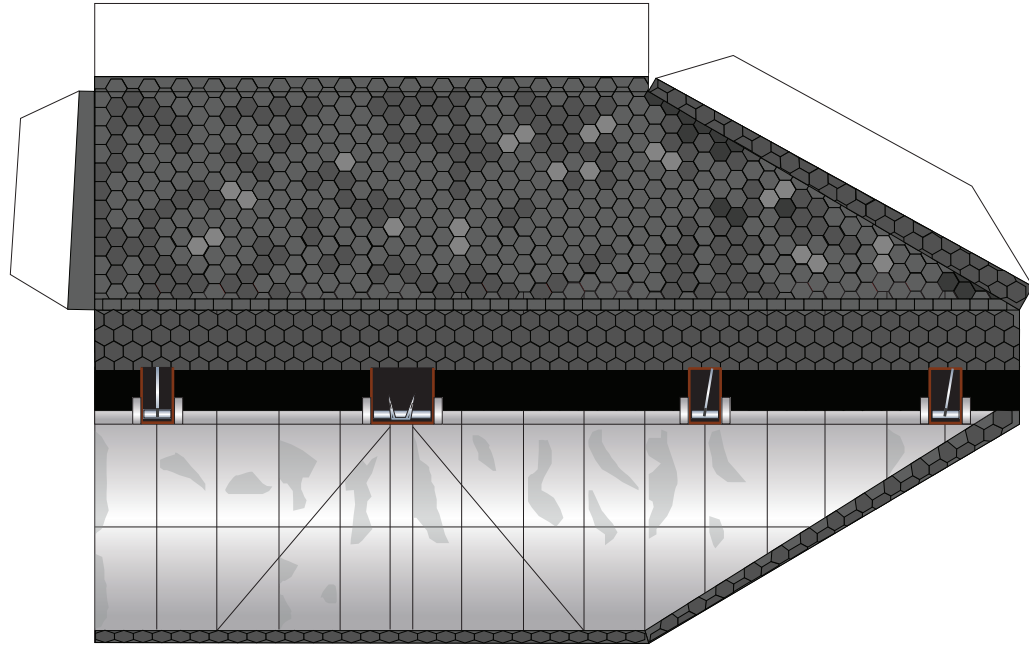



1:100 Scale



SpaceX Starship SN20

Print on Cardstock (110 lbs)

Back bottom

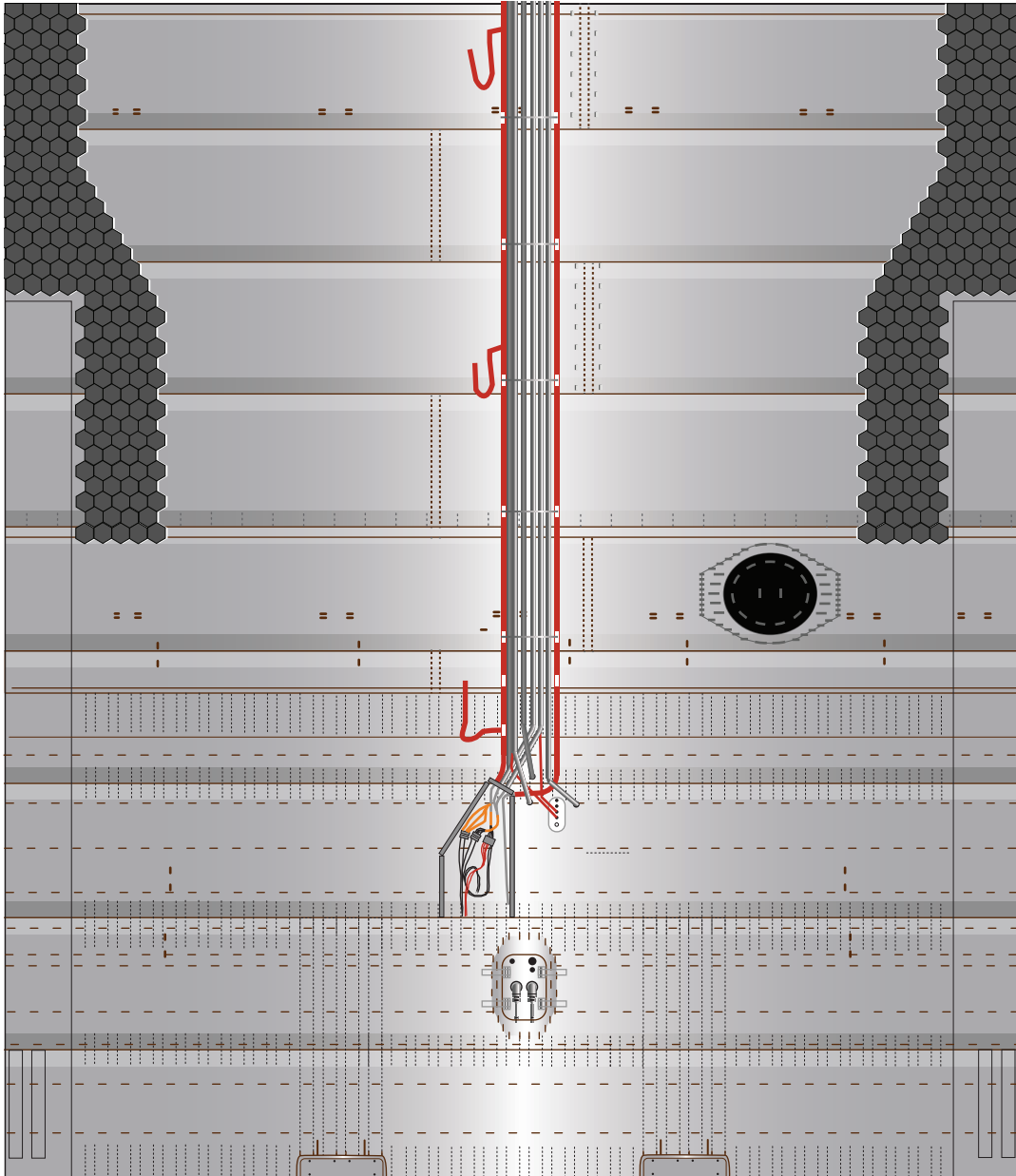
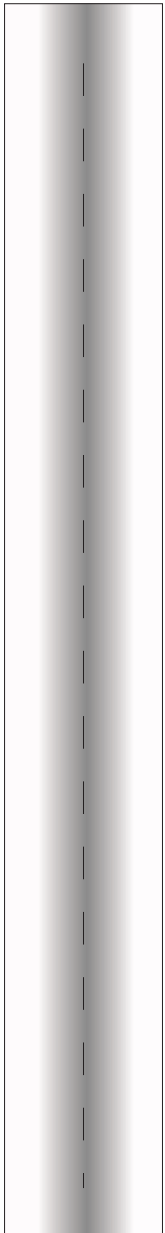
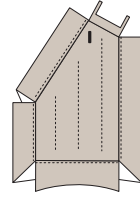



1:100 Scale



SpaceX Starship SN20

Print on Cardstock (110 lbs)

Belly side bottom

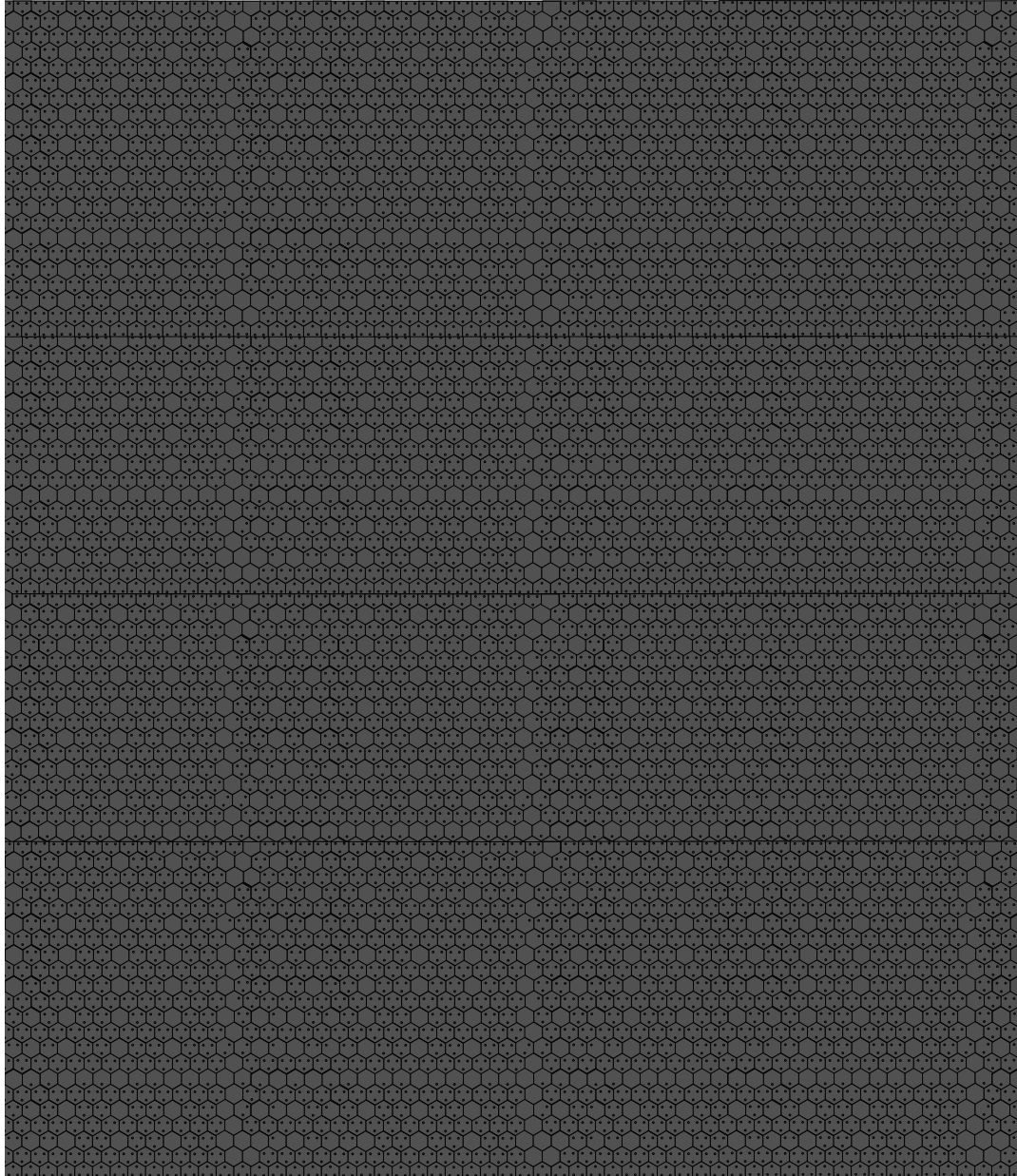
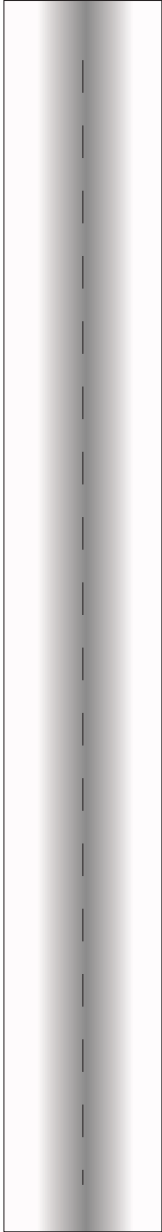



1:100 Scale

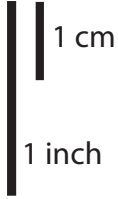

SpaceX Starship SN-20

Print on Cardstock (110 lbs)

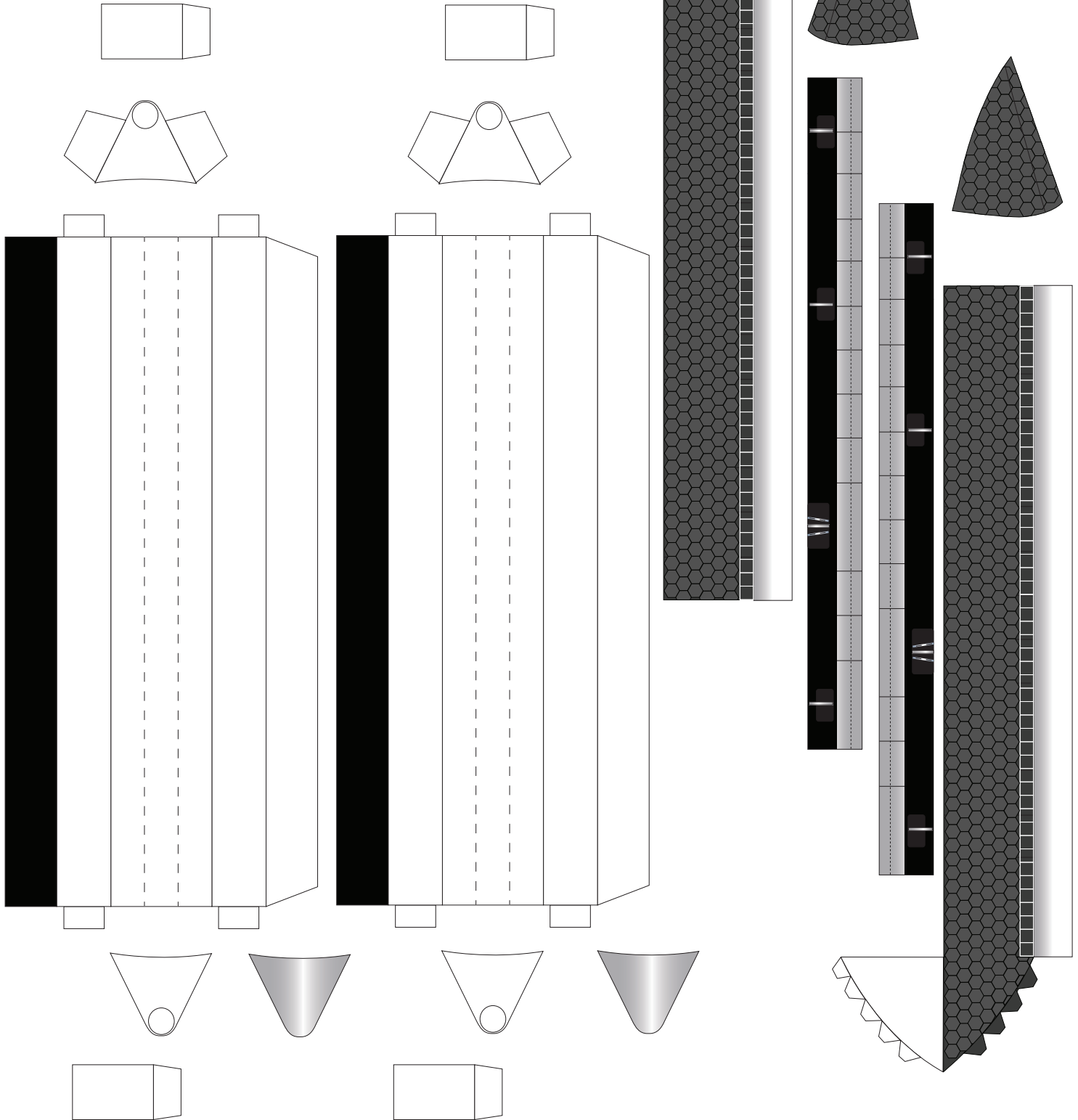



1:100 Scale



SpaceX Starship SN

Print on Cardstock (110 lbs)

Formers for lower body

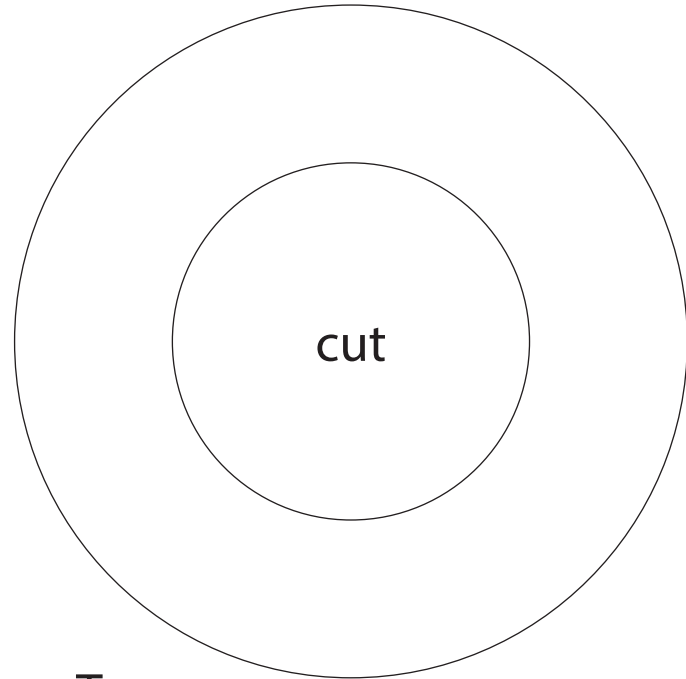

Top

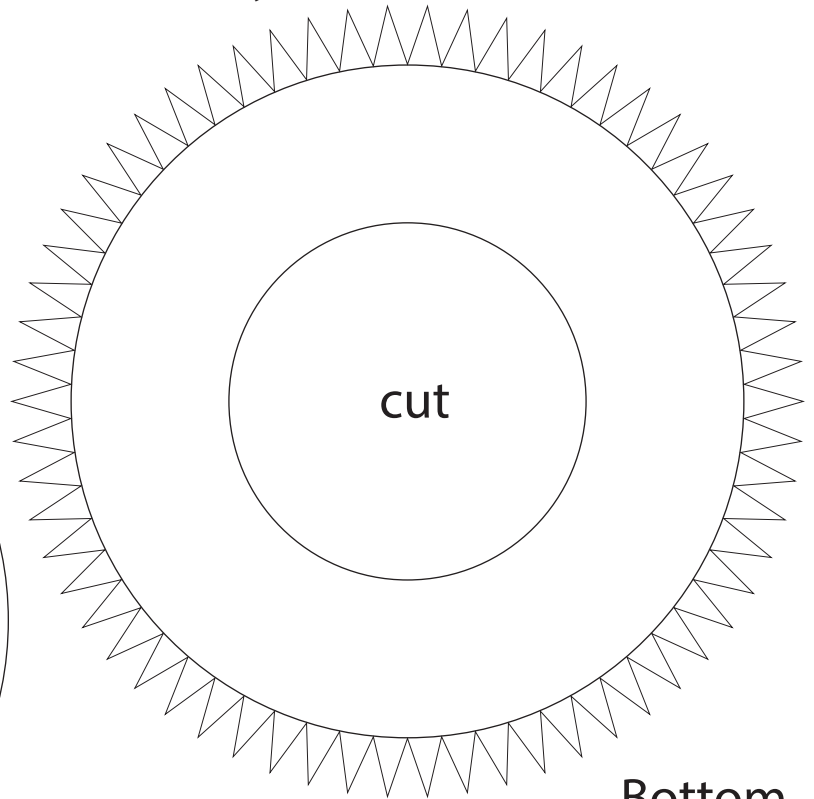

Bottom

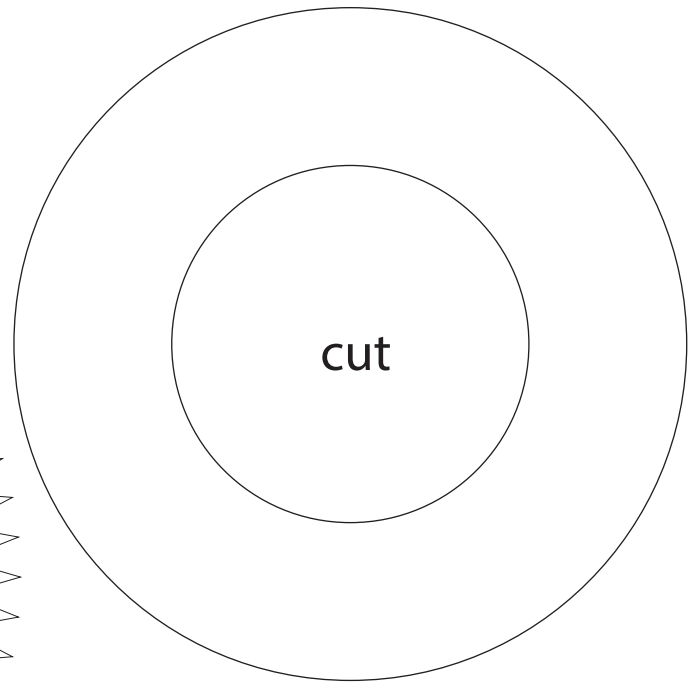
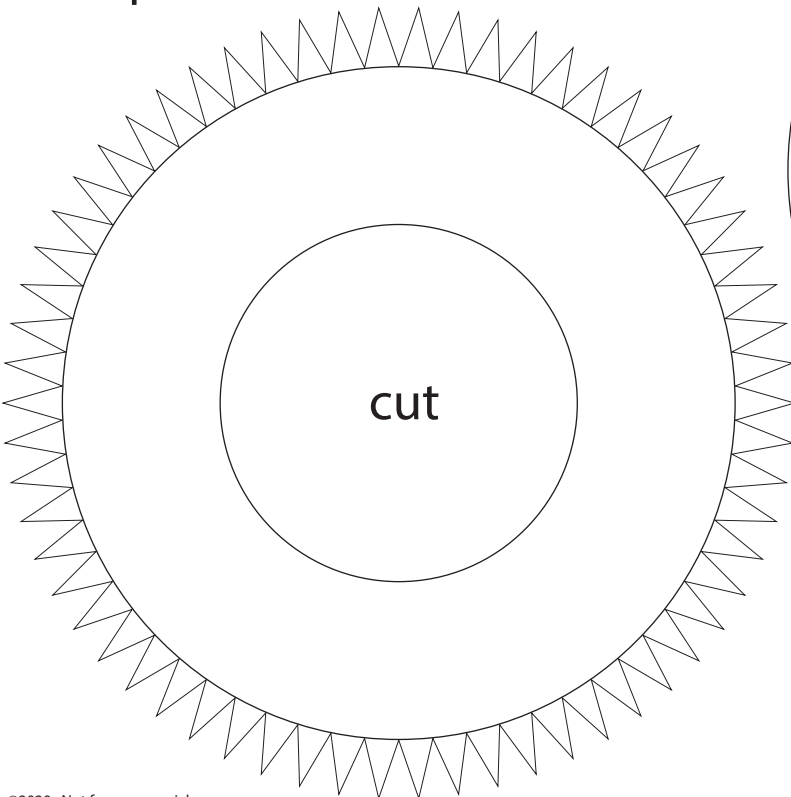

IMPORTANT

Top former is glued 20 mm from bottom edge of upper body.
Bottom former is glued 68 mm from bottom edge of lower body.



1 cm

1 inch

1:100 Scale

SpaceX Starship SN-20

Print on Cardstock (110 lbs)

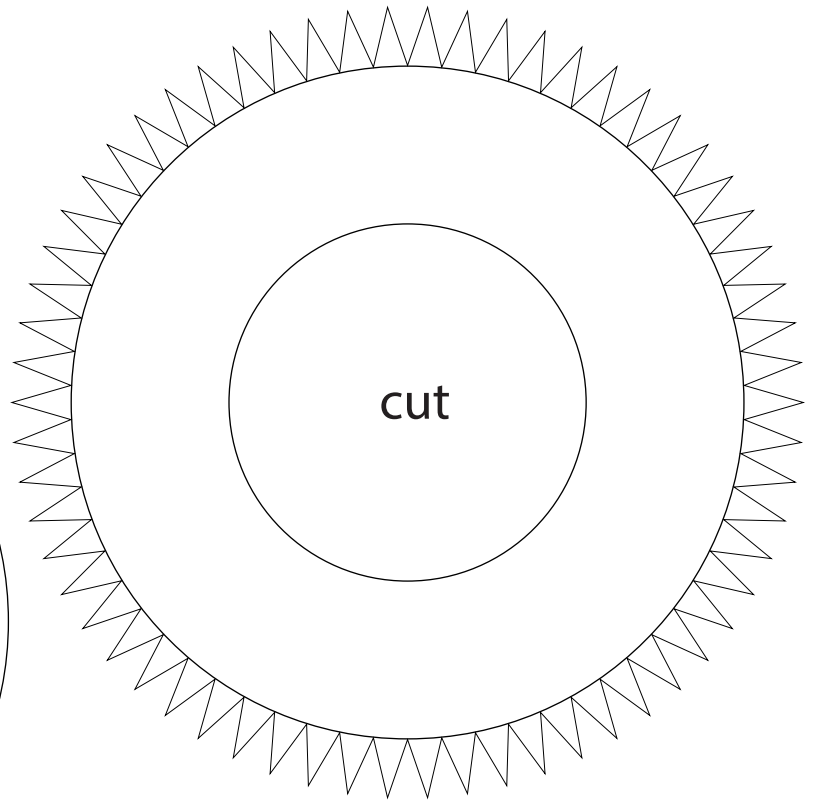
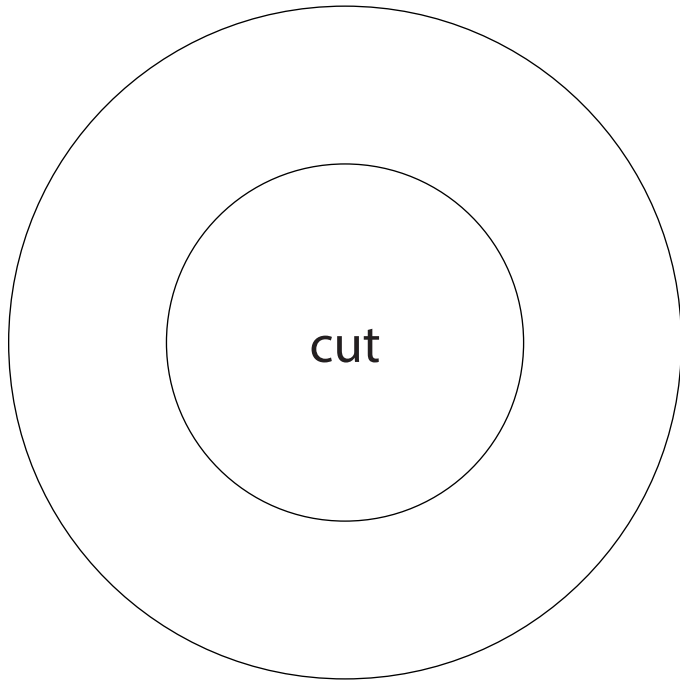

Upper Body former

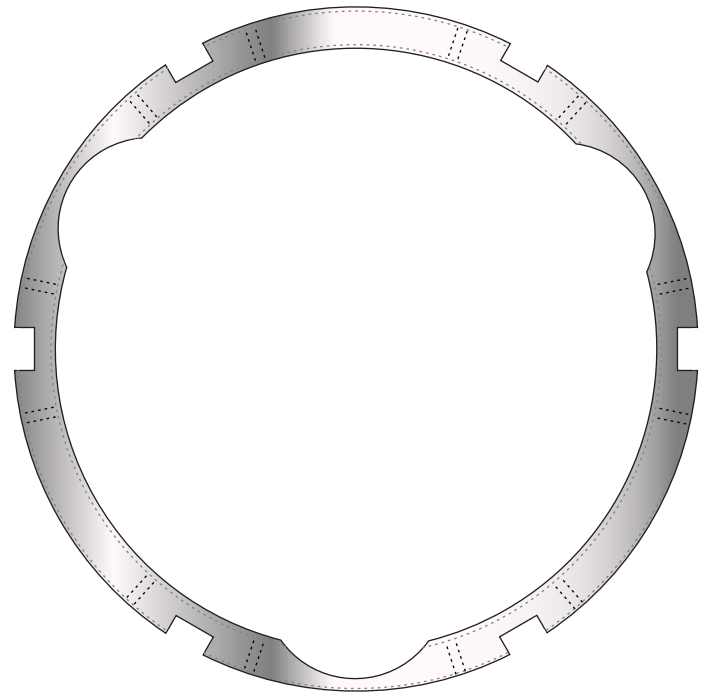
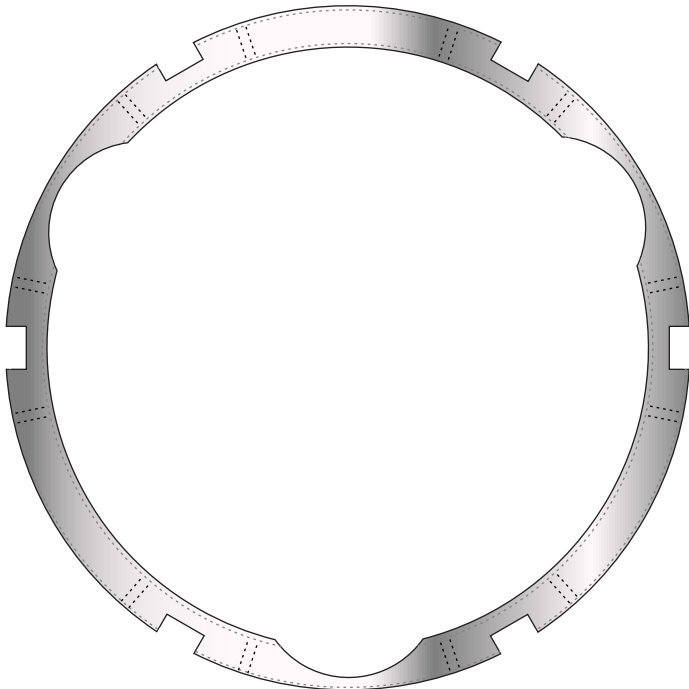

Engine ring



1:100 Scale



SpaceX Starship SN 20

Print on Cardstock (110 lbs)

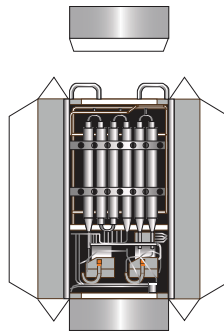

Power Unit

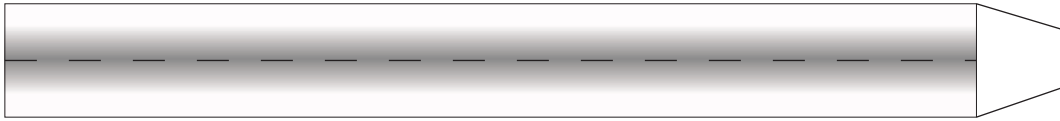

Connectors for upper and lower body

Engine section interior wall

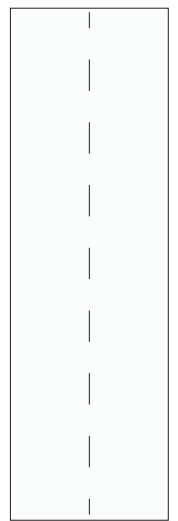
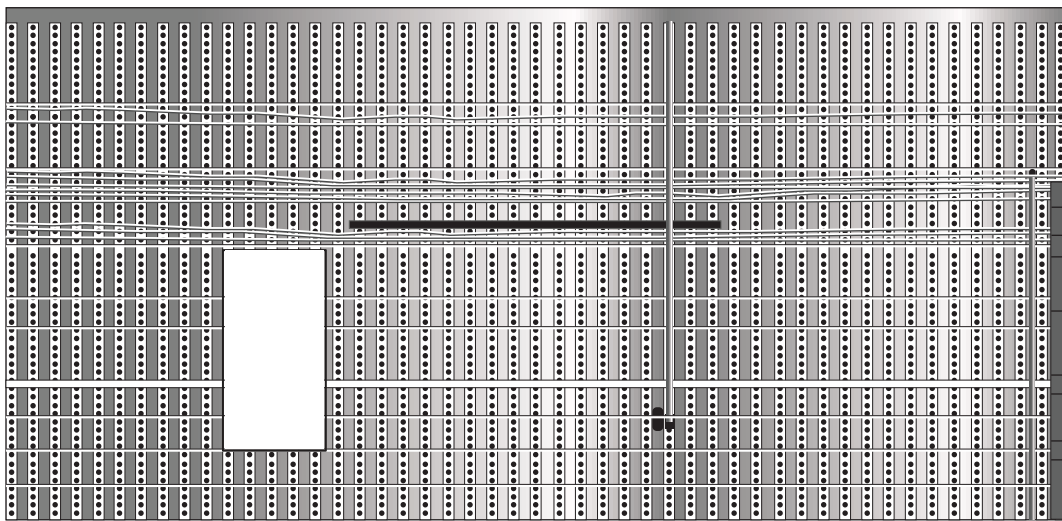
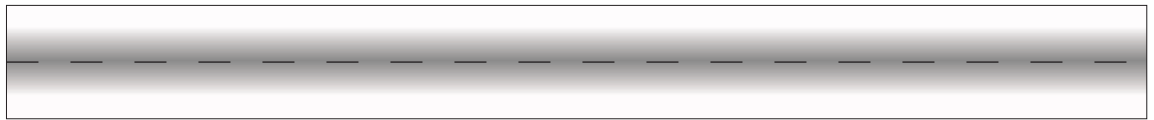

Curve this segment

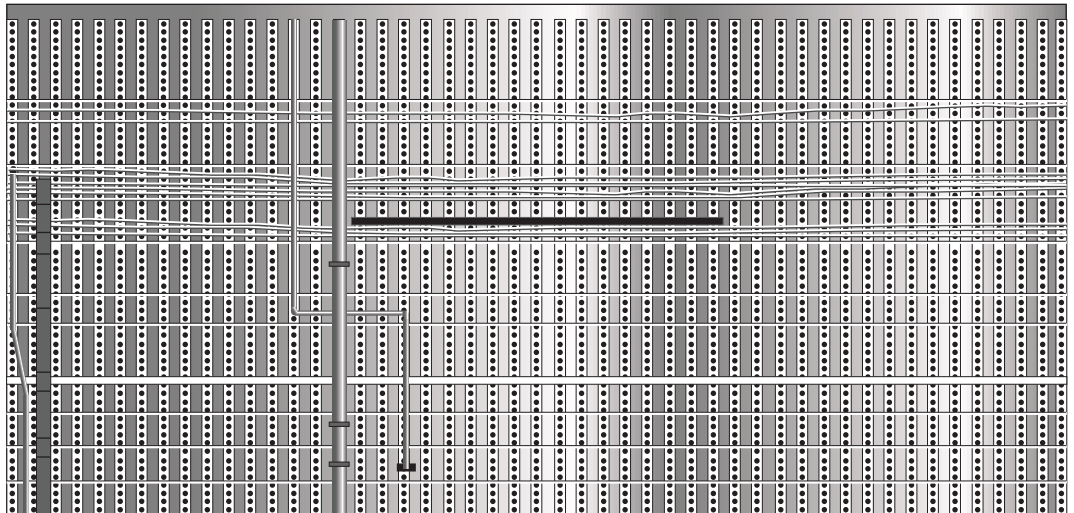
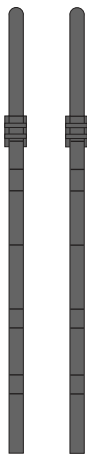
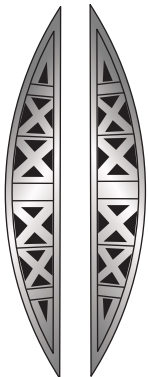



1 cm

1 inch

1:100 Scale

Starship SN 20 Bulkhead

Print on Cardstock (110 lbs)

Use 4x2 mm Deryun magnets

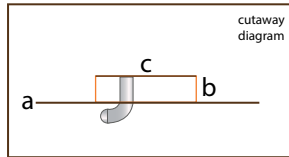

cutaway diagram

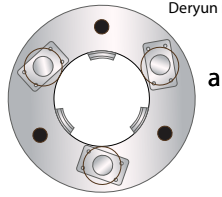

a

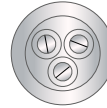

c



b



Diagram

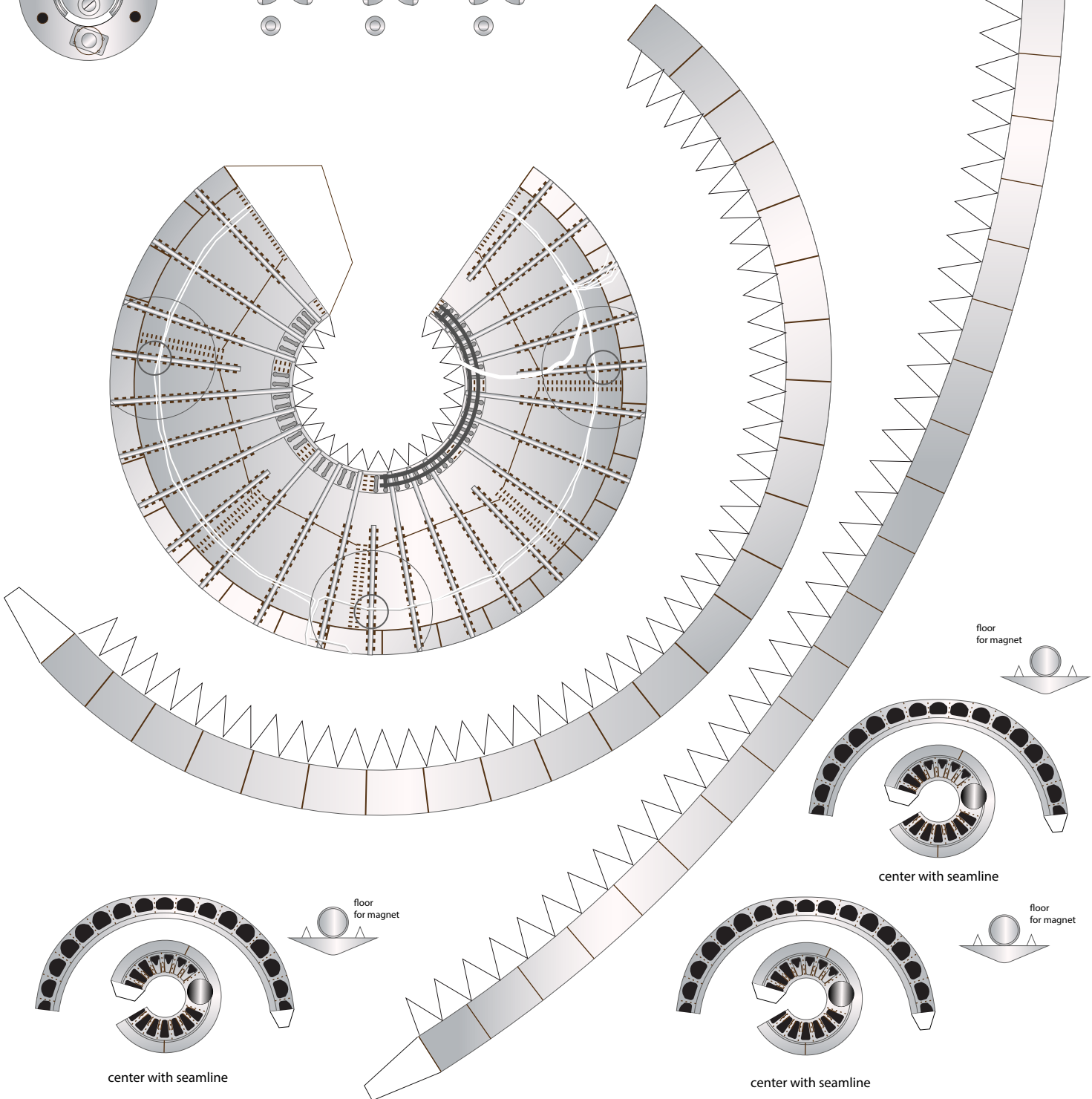
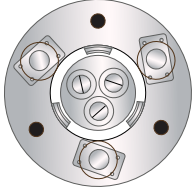

floor for magnet

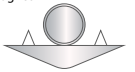

center with seamline

floor for magnet



center with seamline

center with seamline



1 cm

1 inch

1:100 Scale

Vaccum Raptors

Print on cardstock (110 lbs)

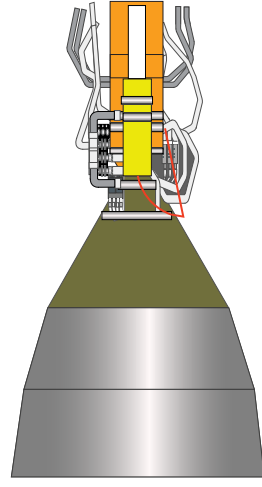
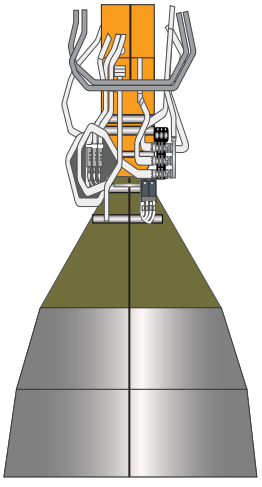
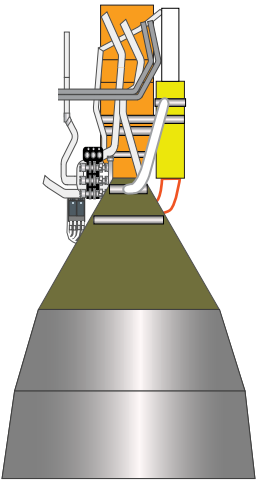
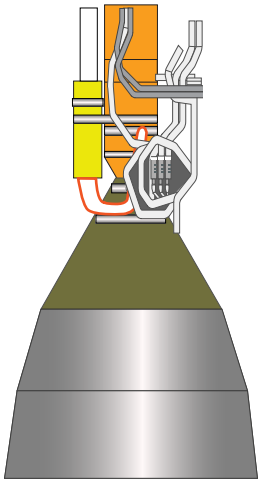
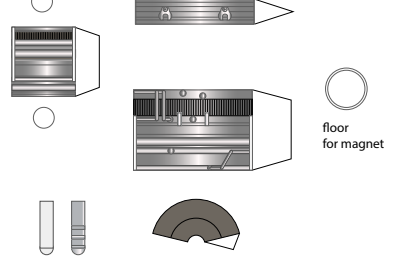
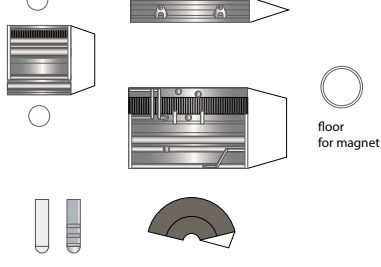
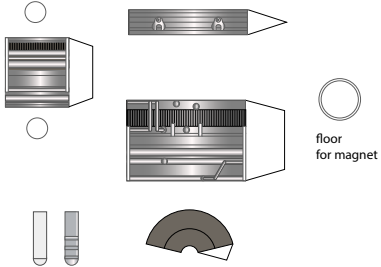
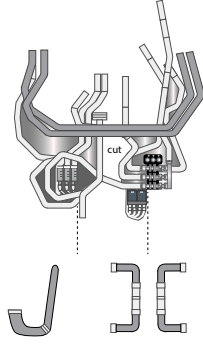
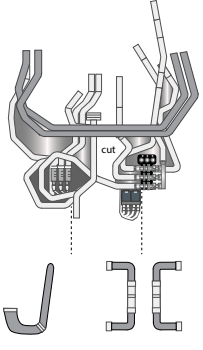
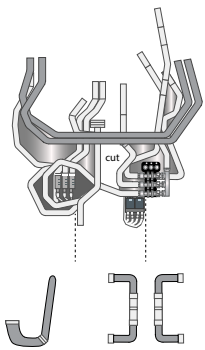
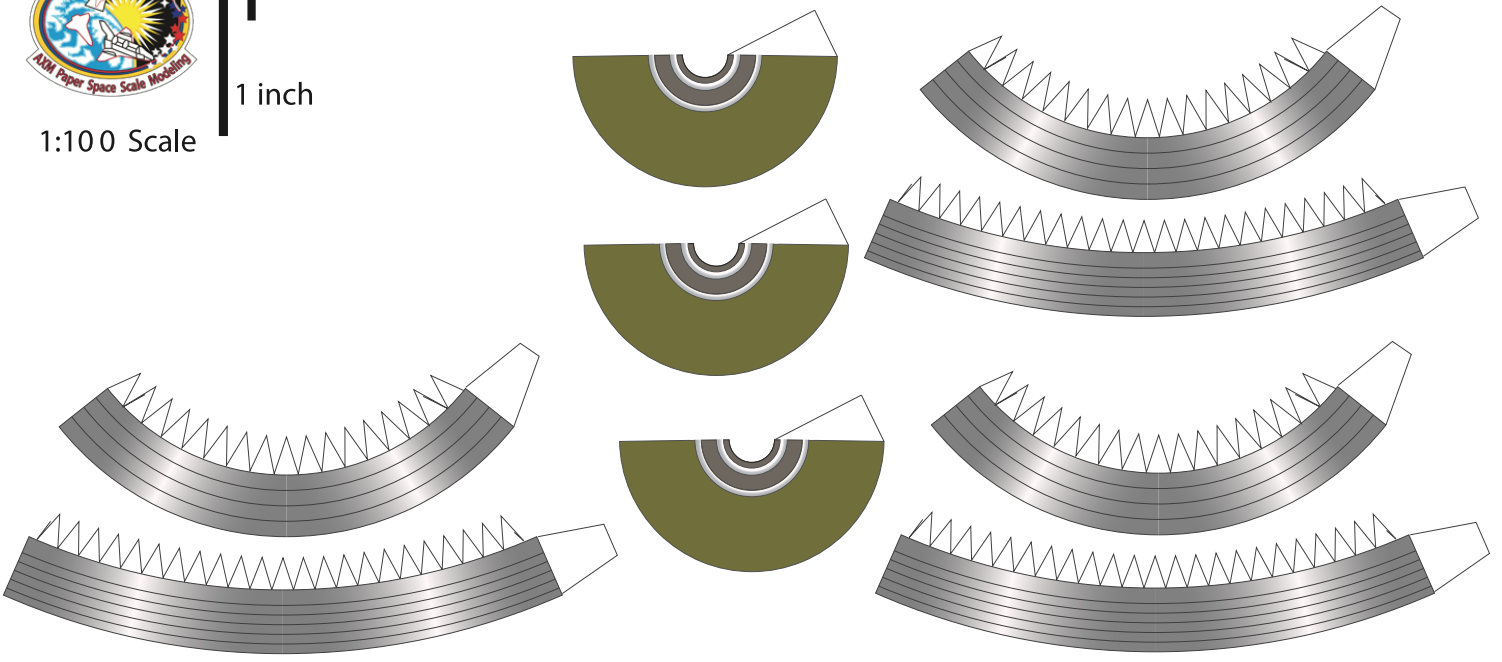

Vaccum Raptors





1 cm

1 inch

1:100 Scale

New Starship Raptor Configuration SN 20

Print on cardstock (110 lbs)

