



LVM3 M2

Print on Cardstock (110 lb)

OneWeb

1:96 Scale

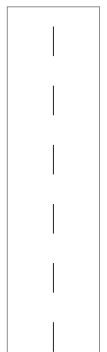
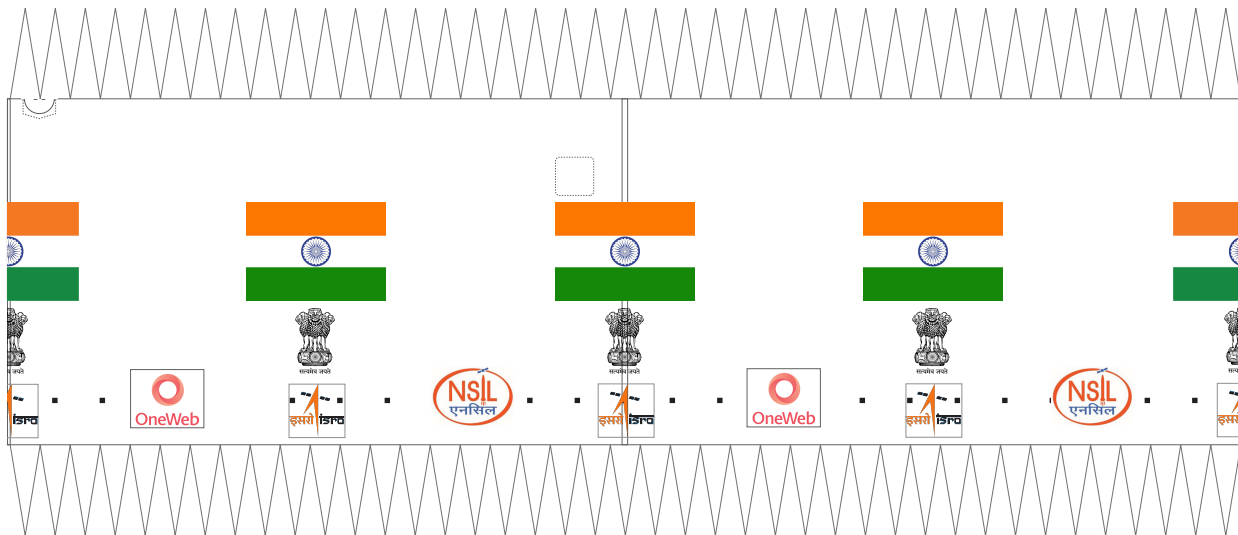
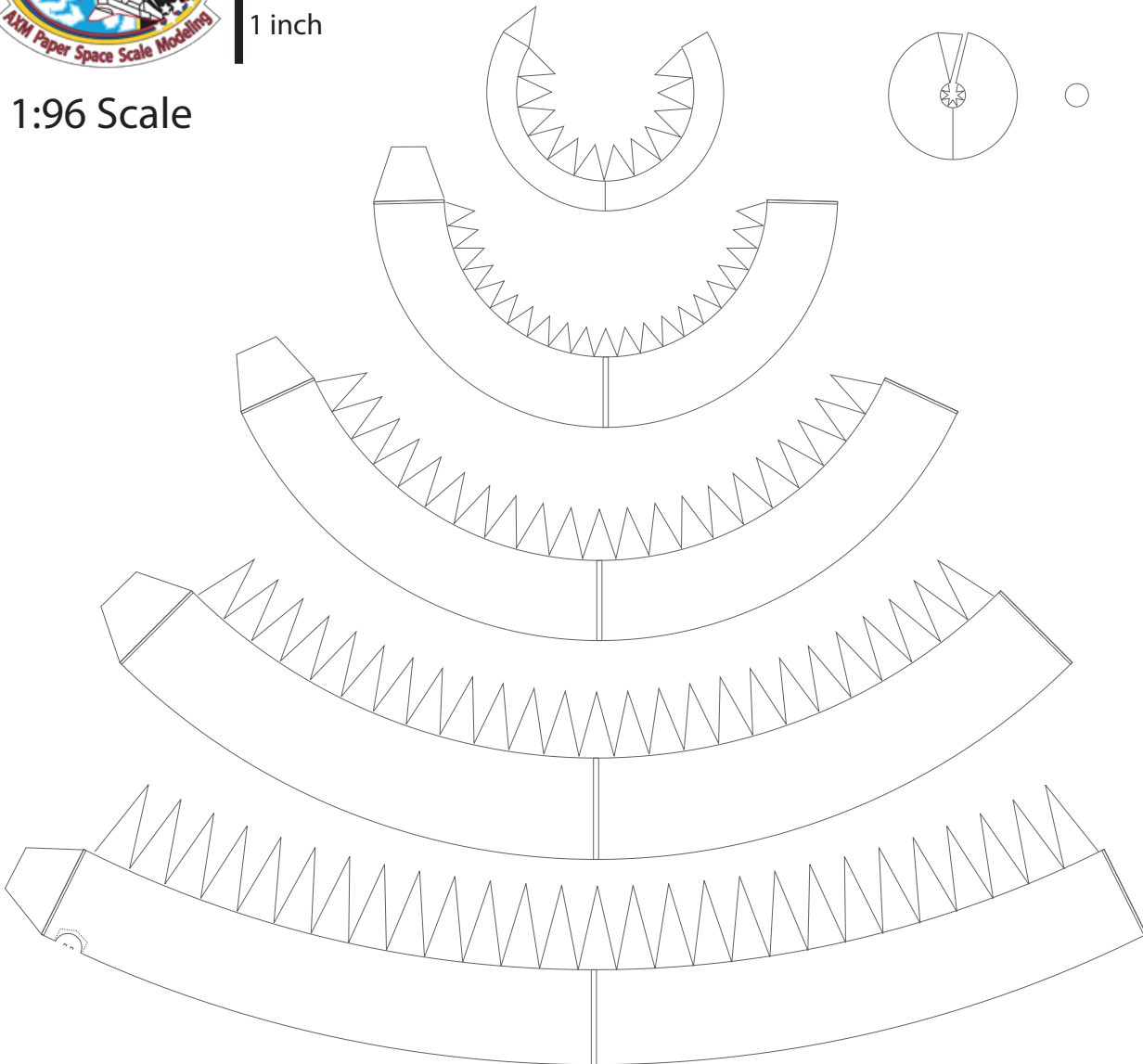



1 cm
1 inch

LVM3 M2

C 25 Cryogenic Upper Stage

Print on Cardstock (110 lb)

1:96 Scale

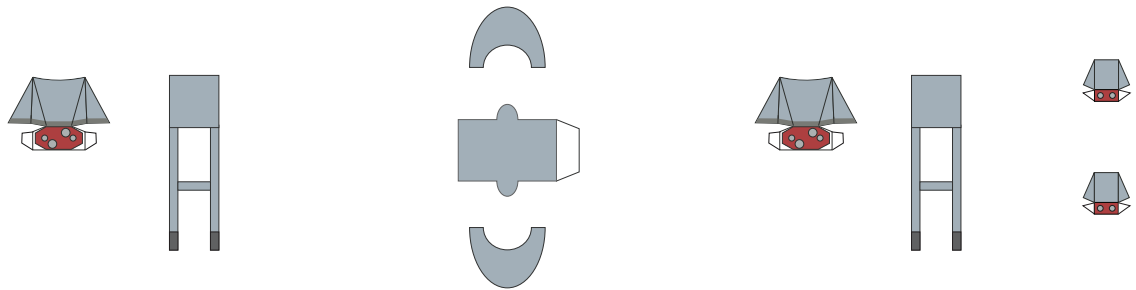
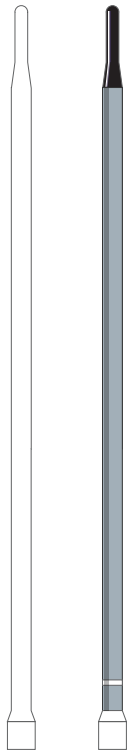
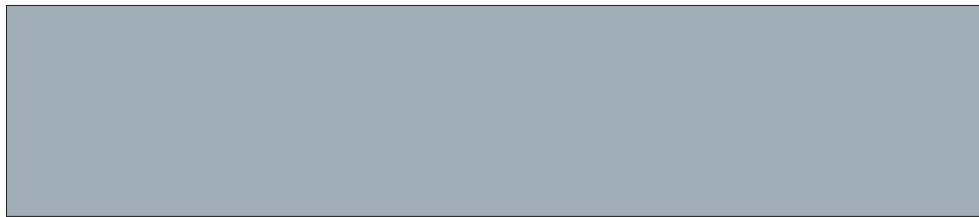
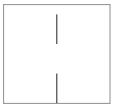
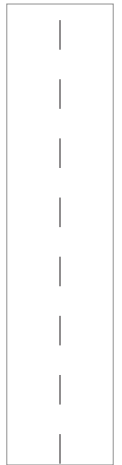
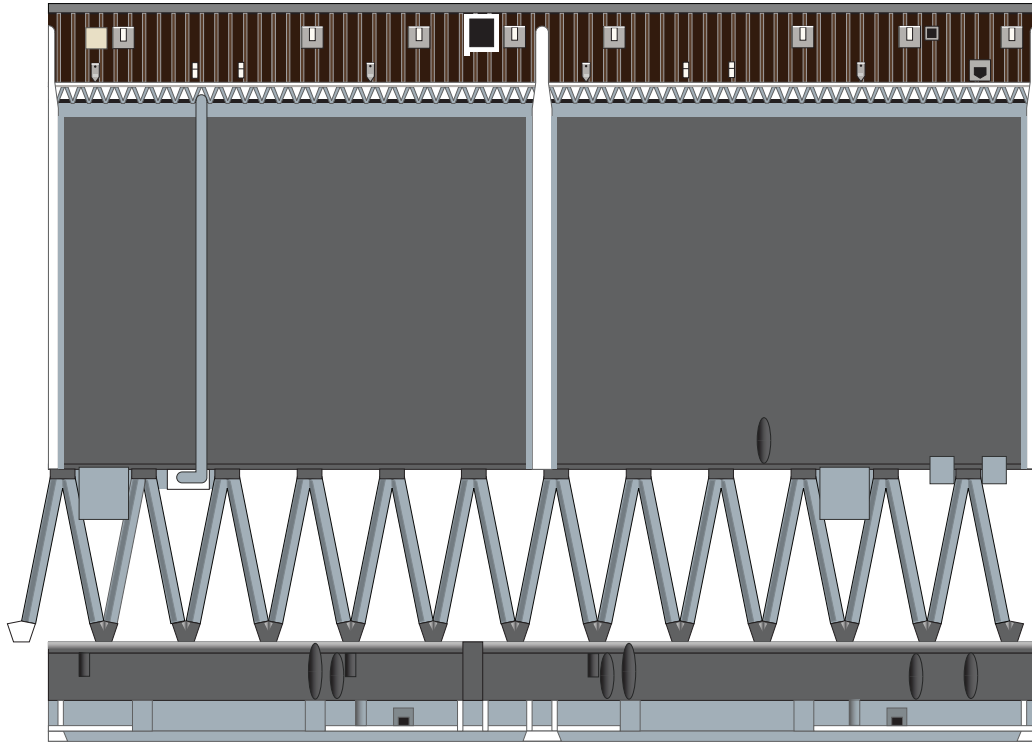
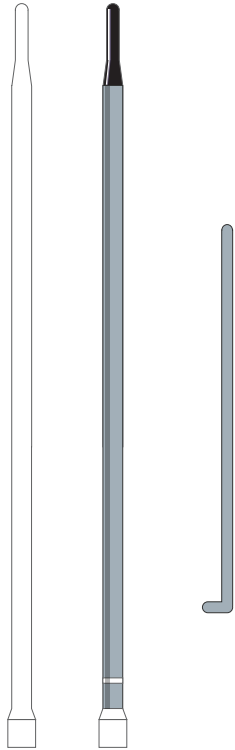



1 cm
1 inch

LVM3 M2

Print on Cardstock (110 lb)

Launch pad configuration (use protective covers)



1:96 Scale

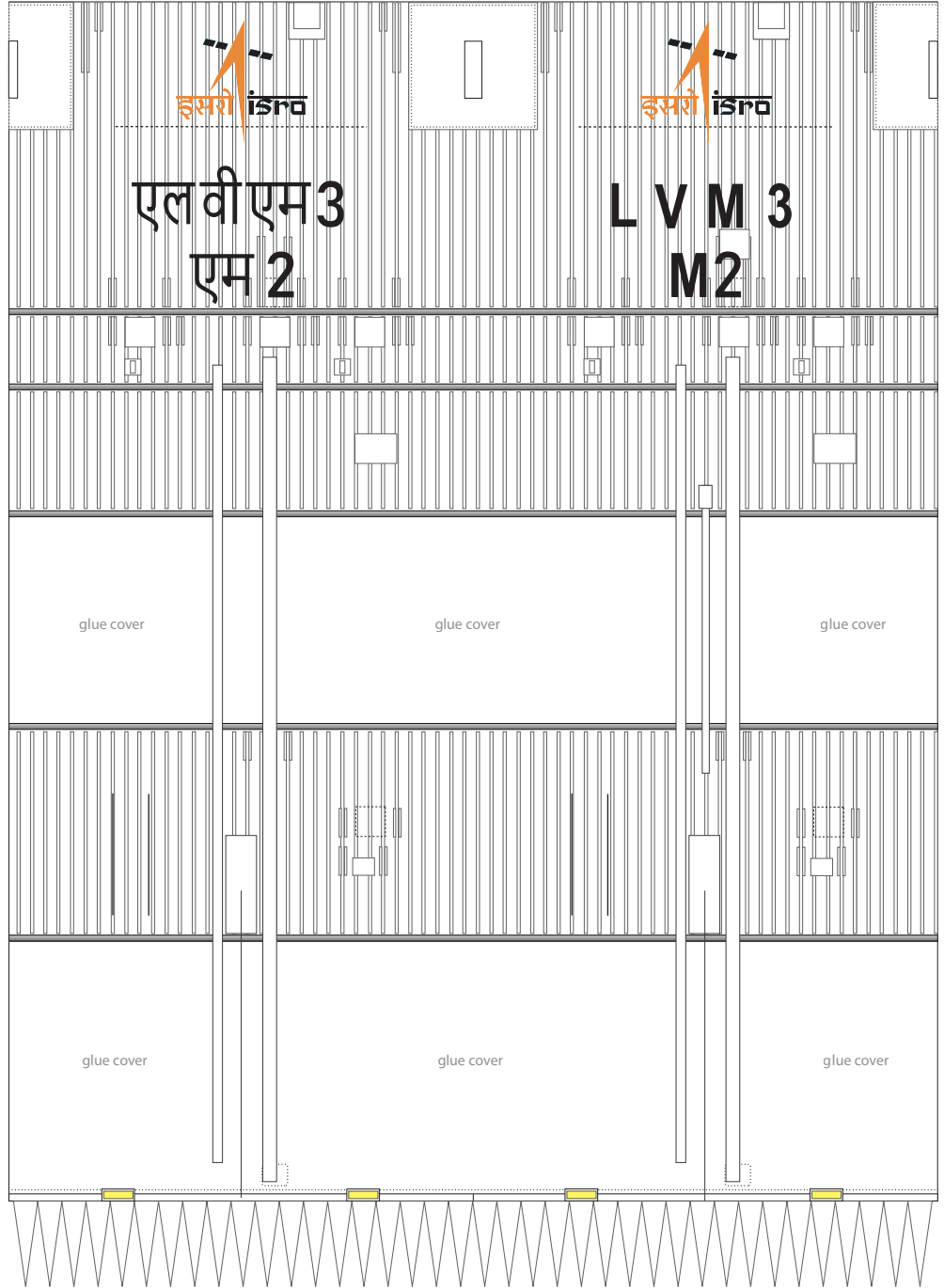
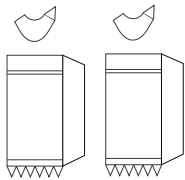
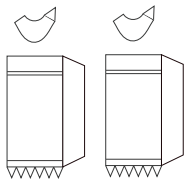
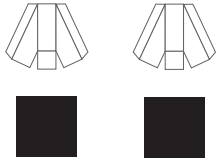
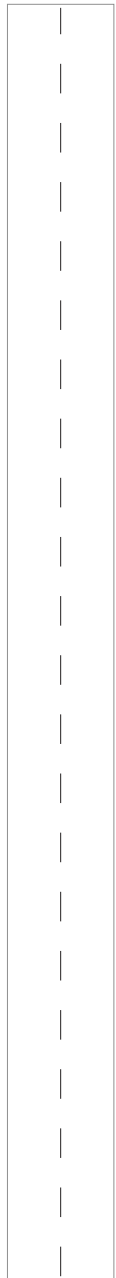

cut out
yellow rectangles





Umbilicals and Covers

Print on Cardstock (110 lb)

GSLV MkIII

1:96 Scale

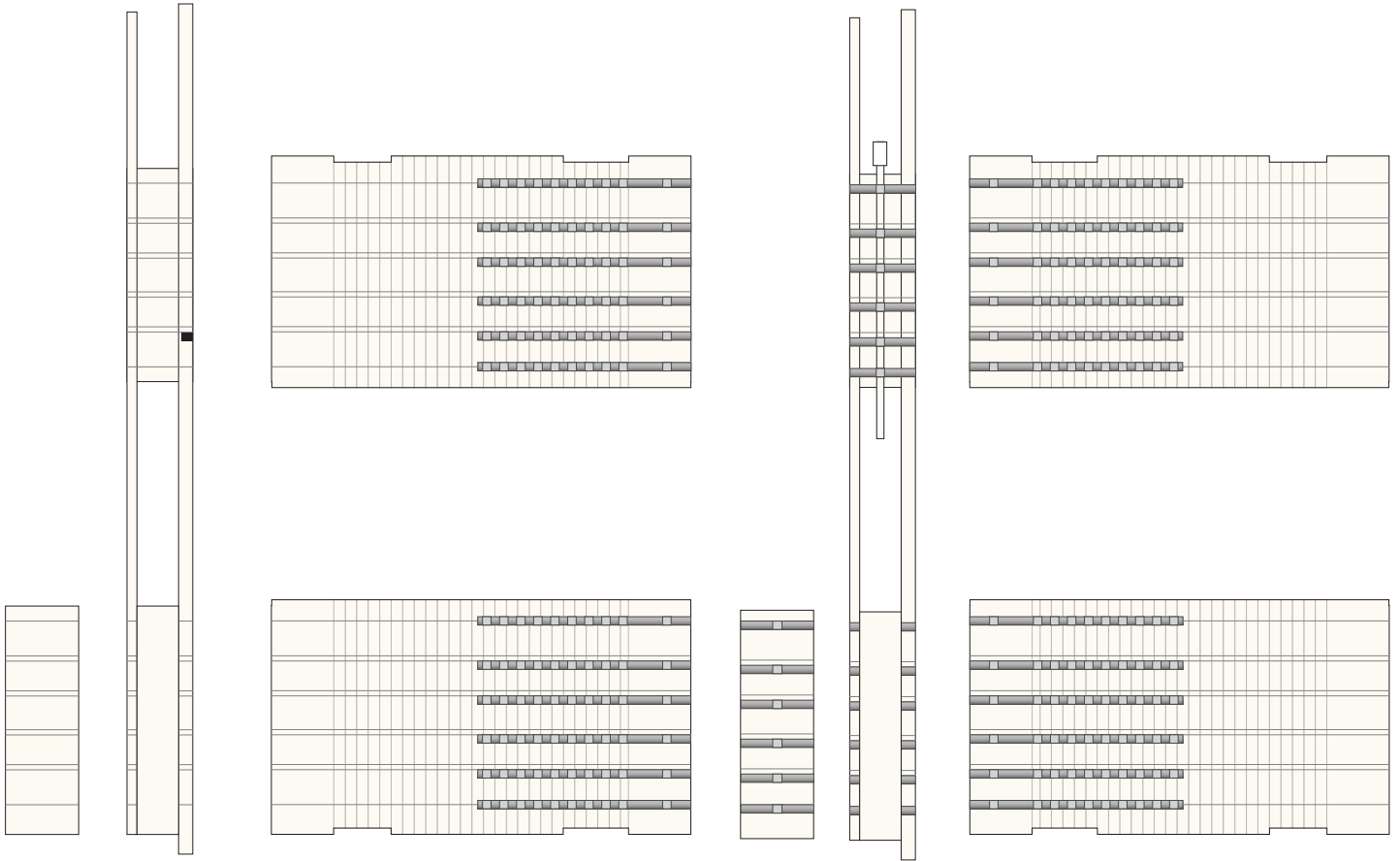



1:96 Scale

PRINT ON PLAIN PAPER GSLV MkIII

Use cottonswabs 47 mm in length
with an aprox. 2.5 mm in width

(Use these skins to cover the swabs)

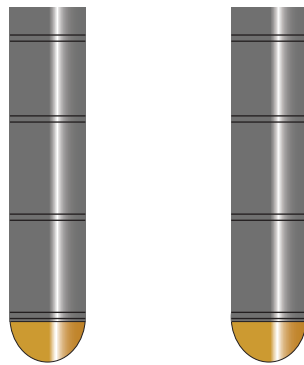



1 cm

1 inch

Engine section

Print on Cardstock (110 lb)

1:96 Scale

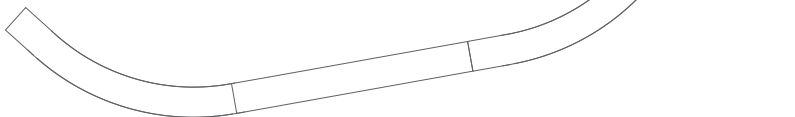
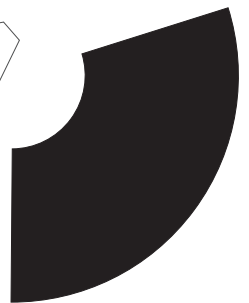
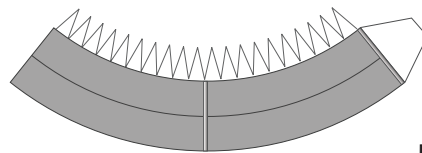
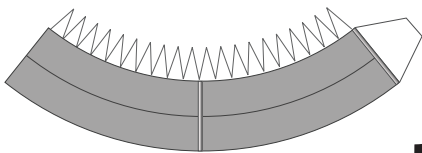
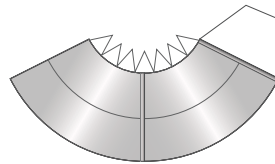
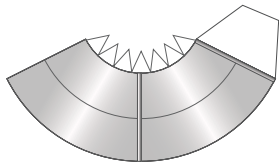
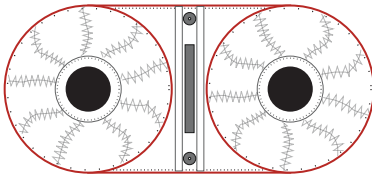
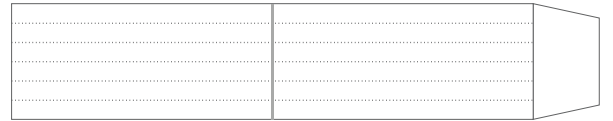
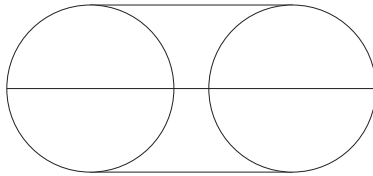
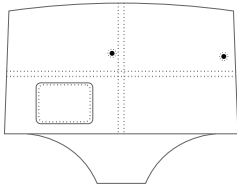
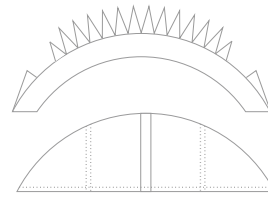
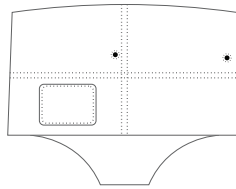
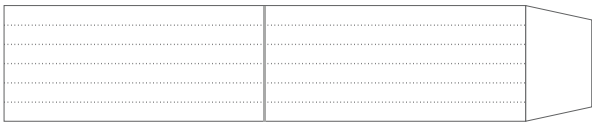
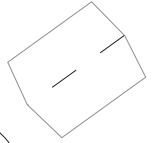
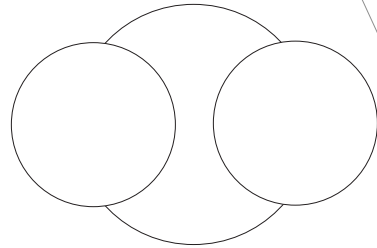
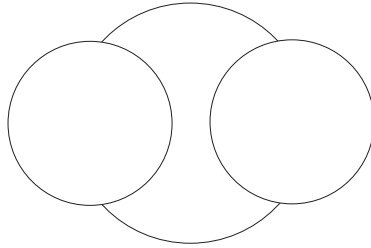
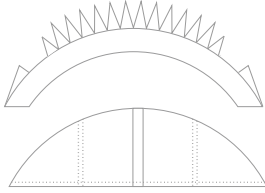
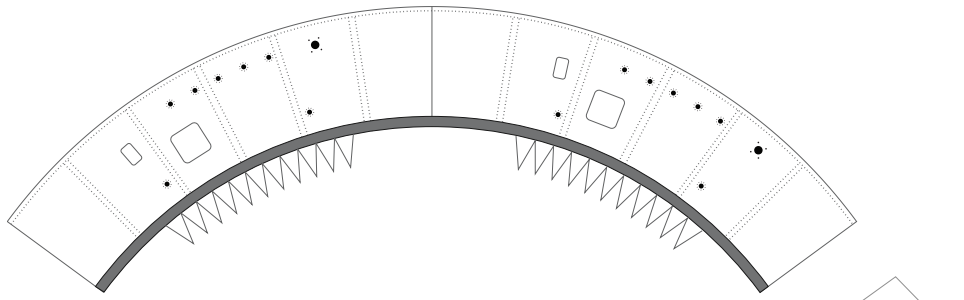



1 cm
1 inch

LVM3 M2

Print on Cardstock (110 lb)

1:96 Scale



Fairing base

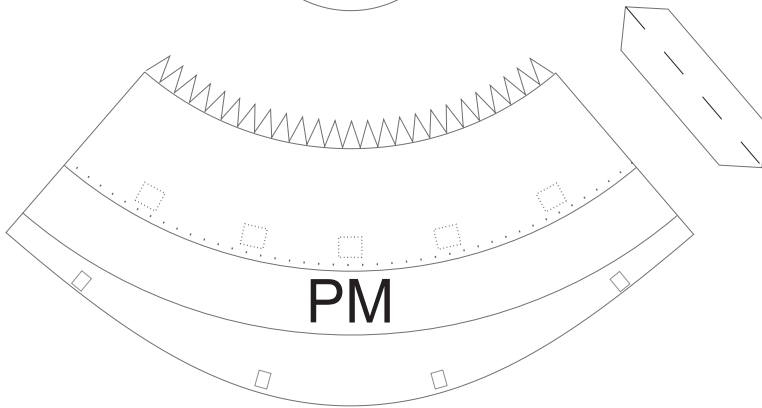
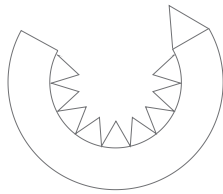

PM

Left

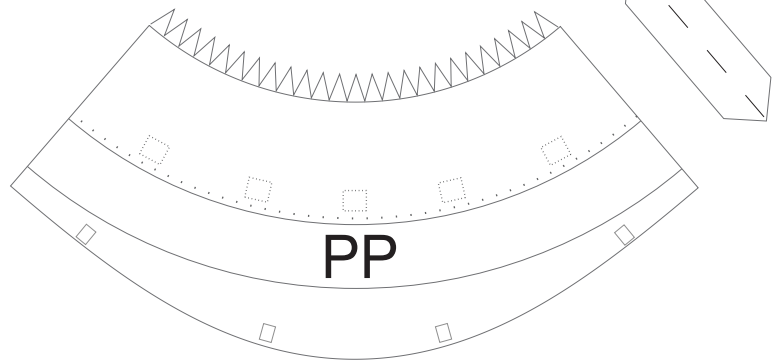
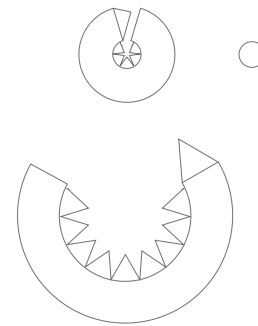

PP

Right



1 cm
1 inch

1:96 Scale



LVM3 M2

Left SRB

Print on Cardstock (110 lb)

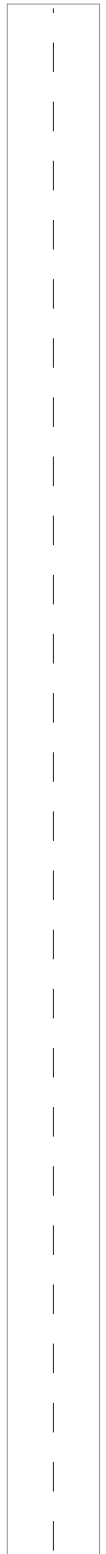
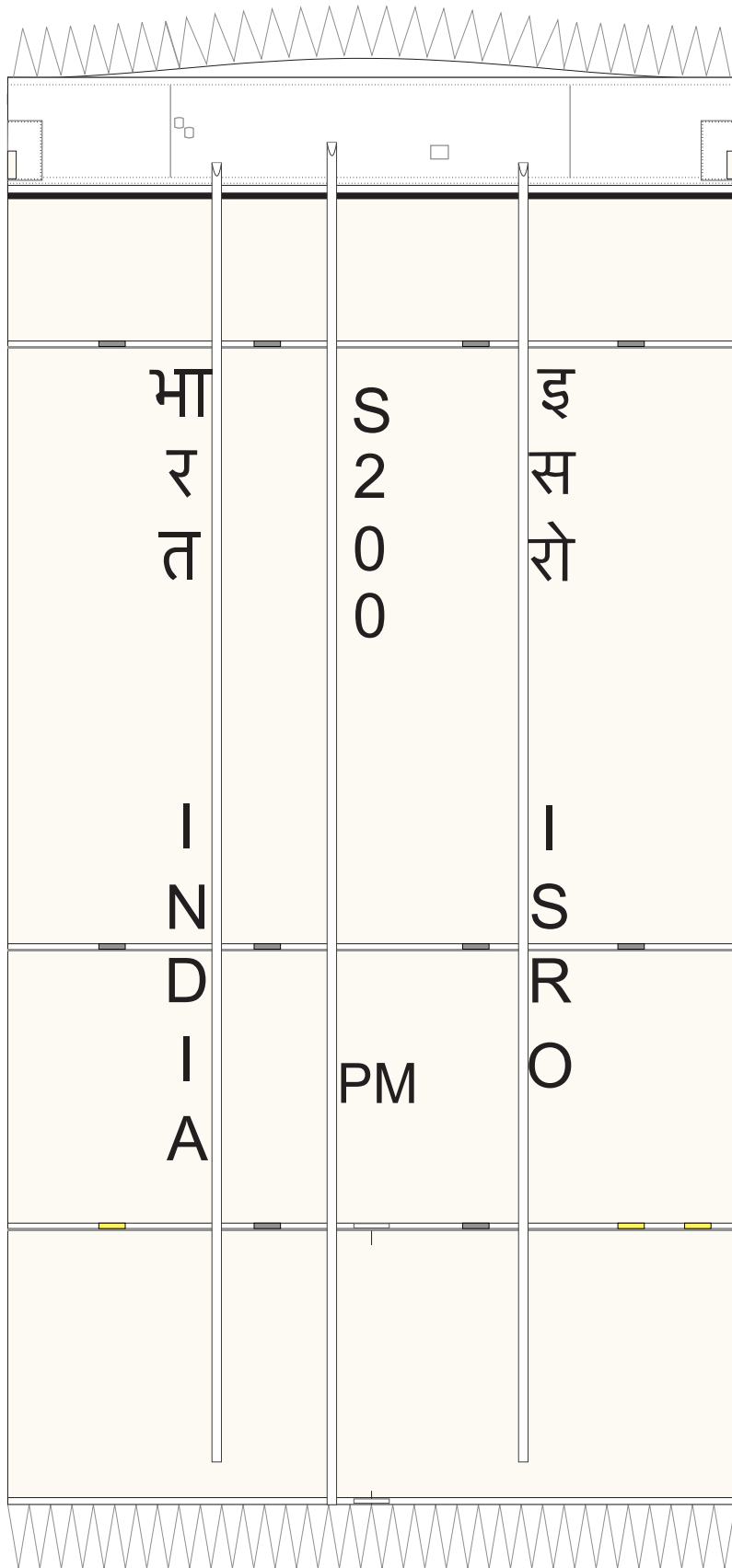

cut out yellow rectangles

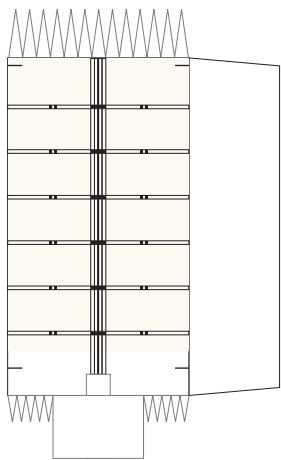
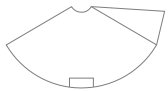



1 cm
1 inch

1:96 Scale



LVM3 M2

Right SRB

Print on Cardstock (110 lb)

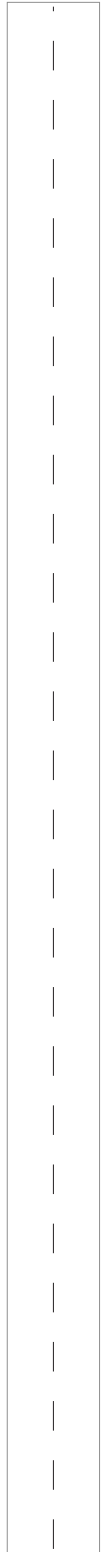
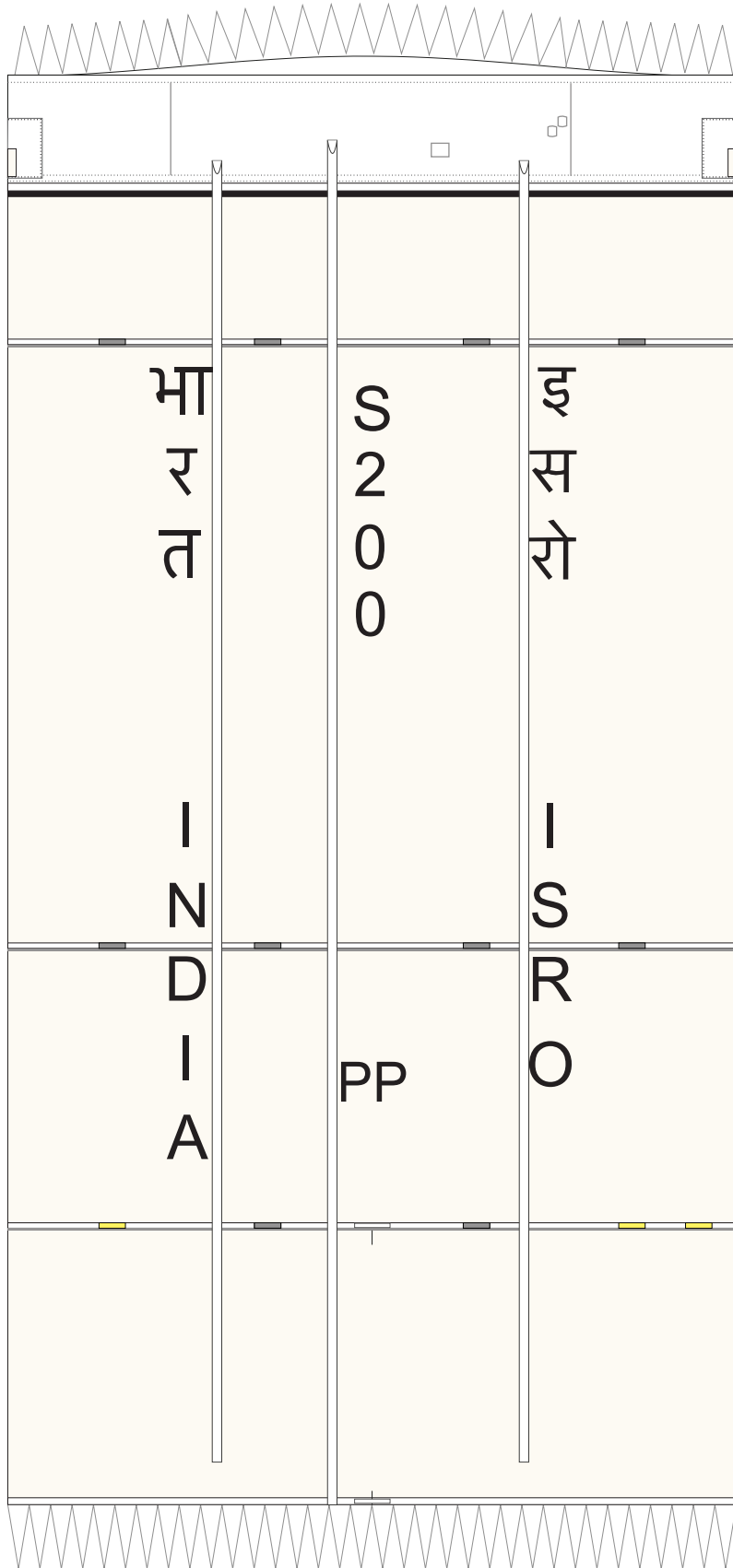

cut out yellow rectangles

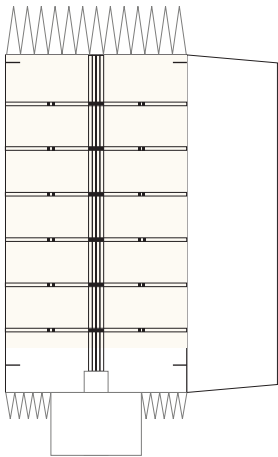
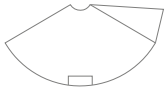



Booster attachments

Print on Cardstock (110 lb)

1:96 Scale

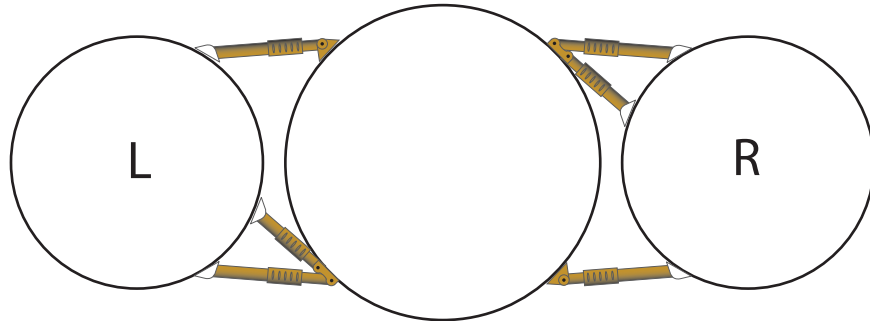

top	Left booster	bottom

bottom	Right booster	top



1 cm
1 inch

GSLV MK-III

Print on Cardstock (110 lb)

1:96 Scale

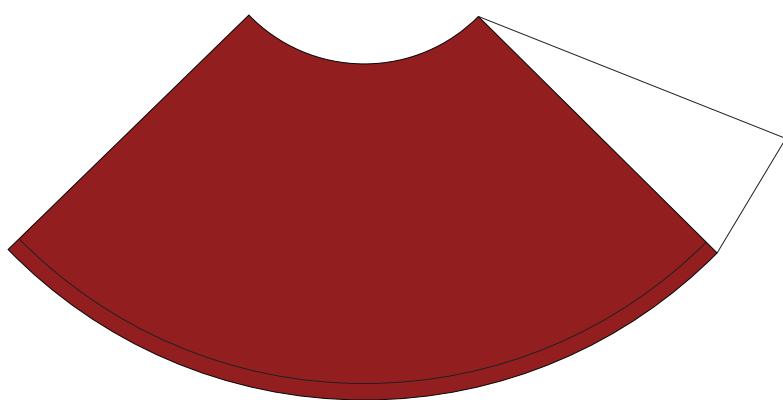
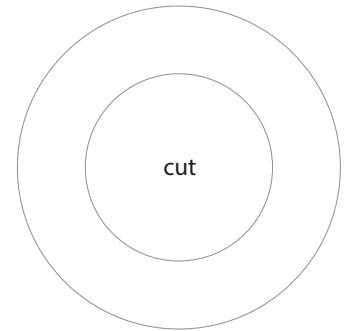
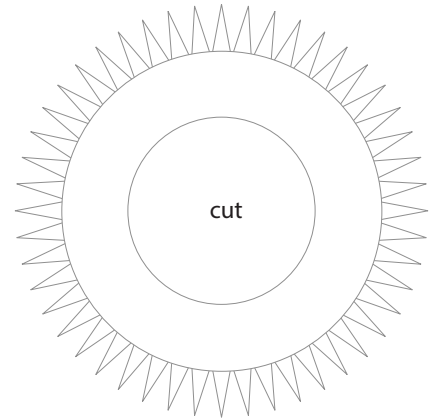
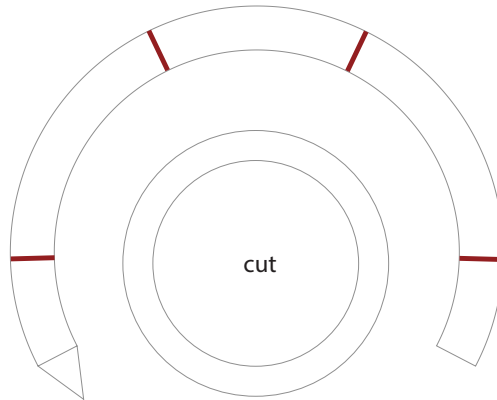
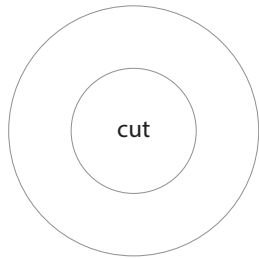
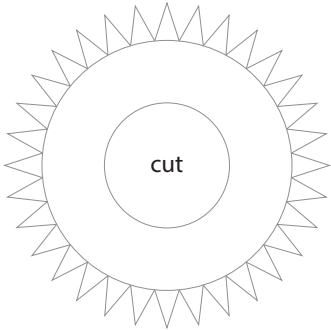
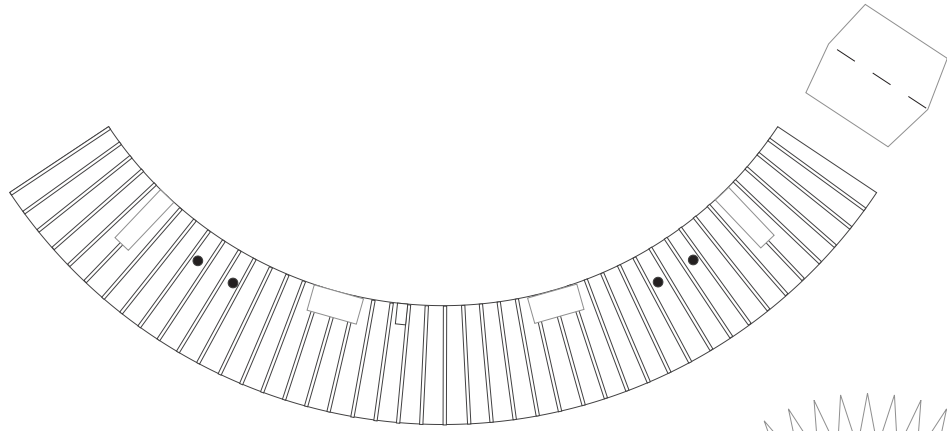



1 cm
1 inch

GSLV MK-III

Print on Cardstock (110 lb)

1:96 Scale

