



1 cm
1 inch

Space Launch System (SLS)

Print on Cardstock (110 lbs)

ARTEMIS Launch Abort System

1:96 Scale

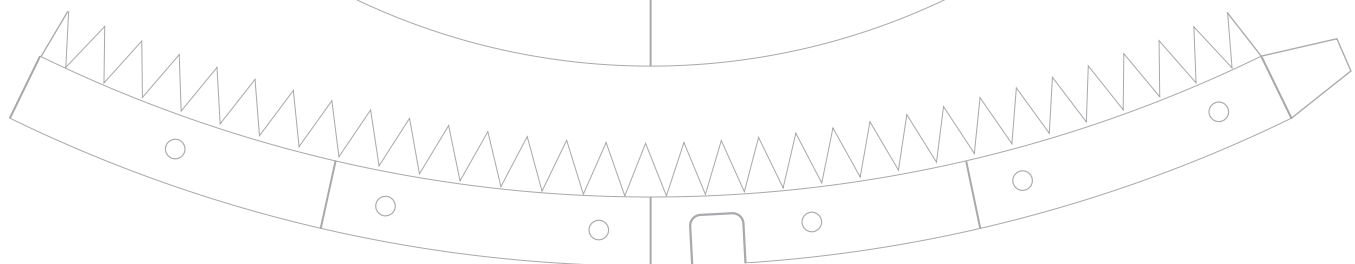
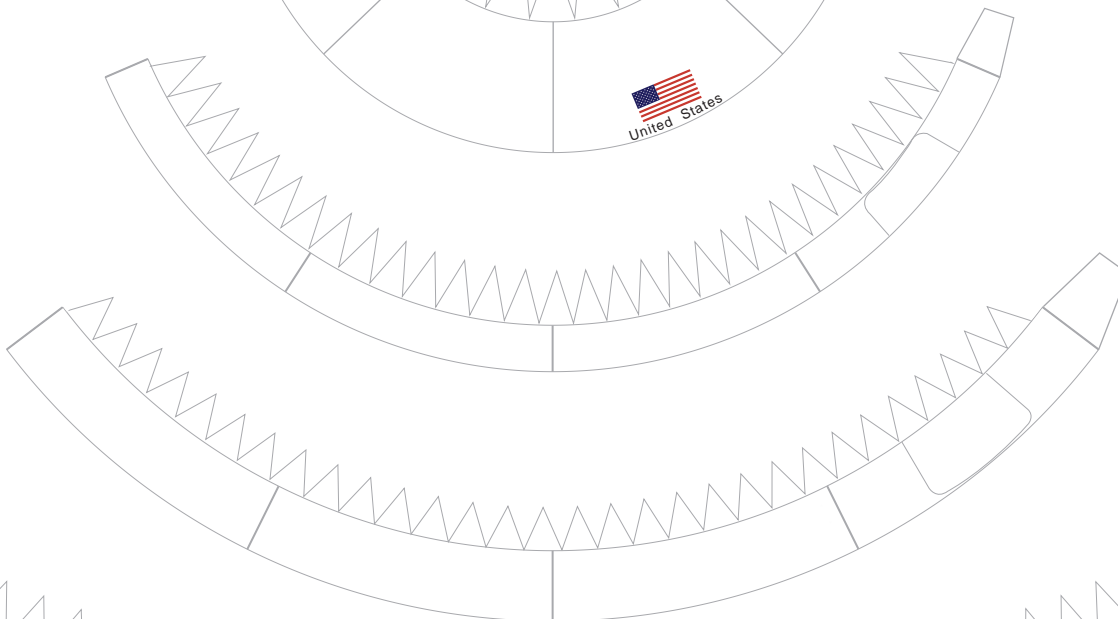
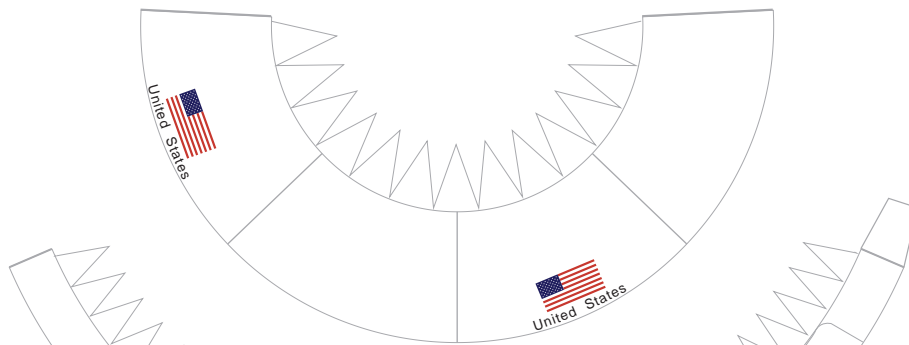
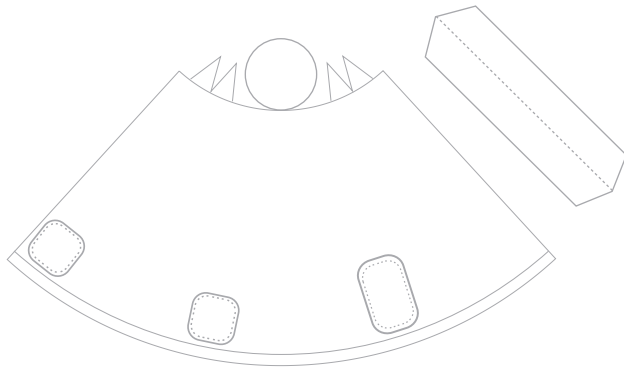
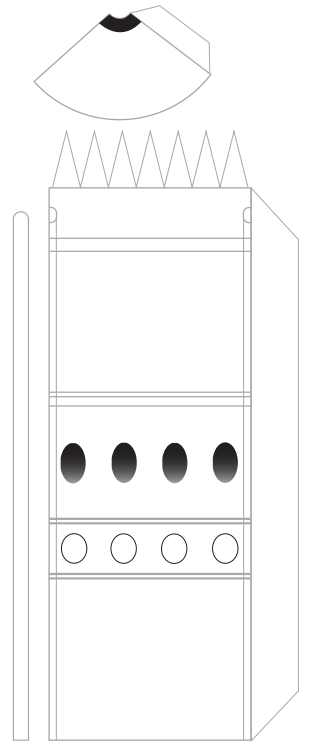
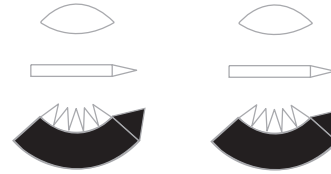
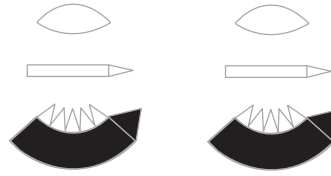



1 cm
1 inch

ORION Artemis-1



Print on Cardstock (110 lbs)

Revised

A1

Glue A1

1:96 Scale

ORION's heatshield

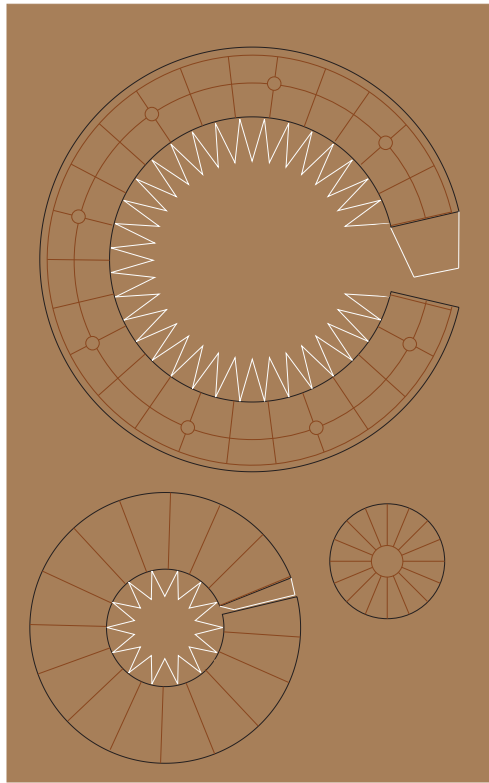

Orion's capsule adaptor

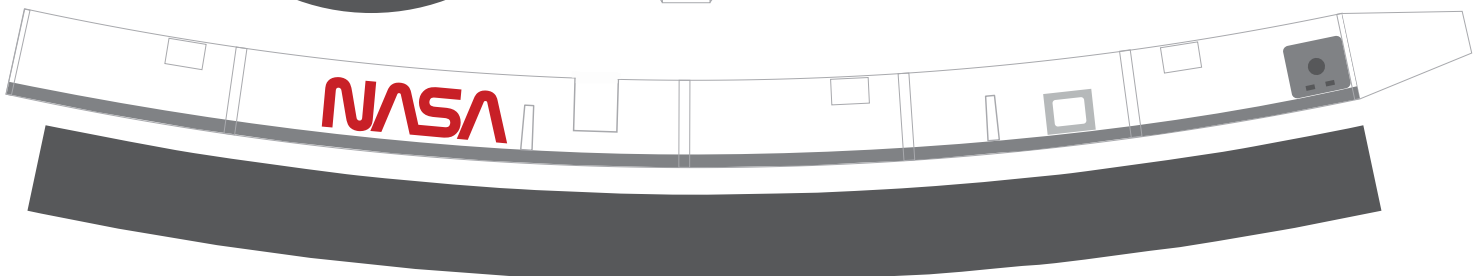
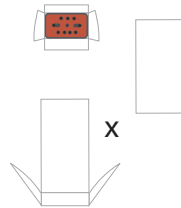
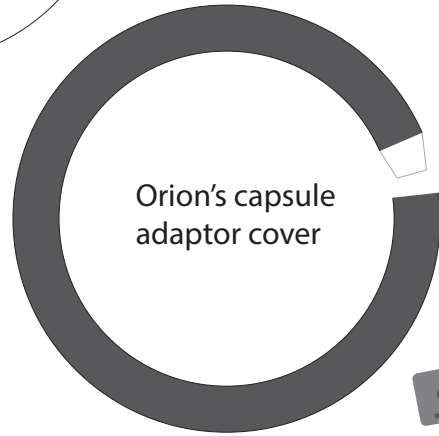
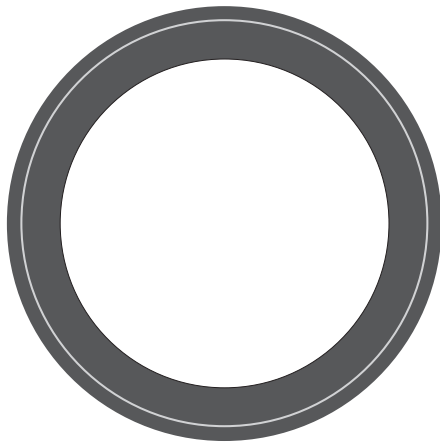
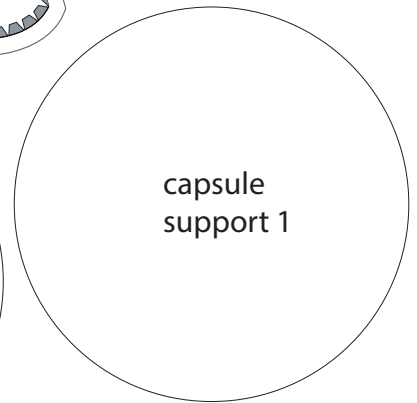
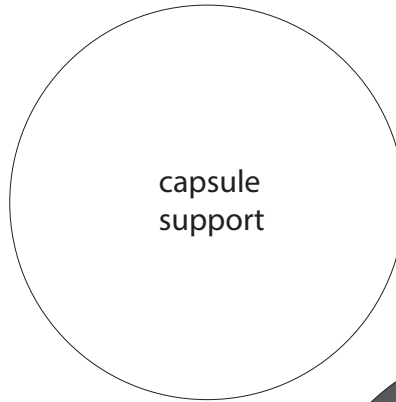
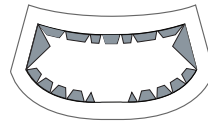
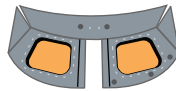
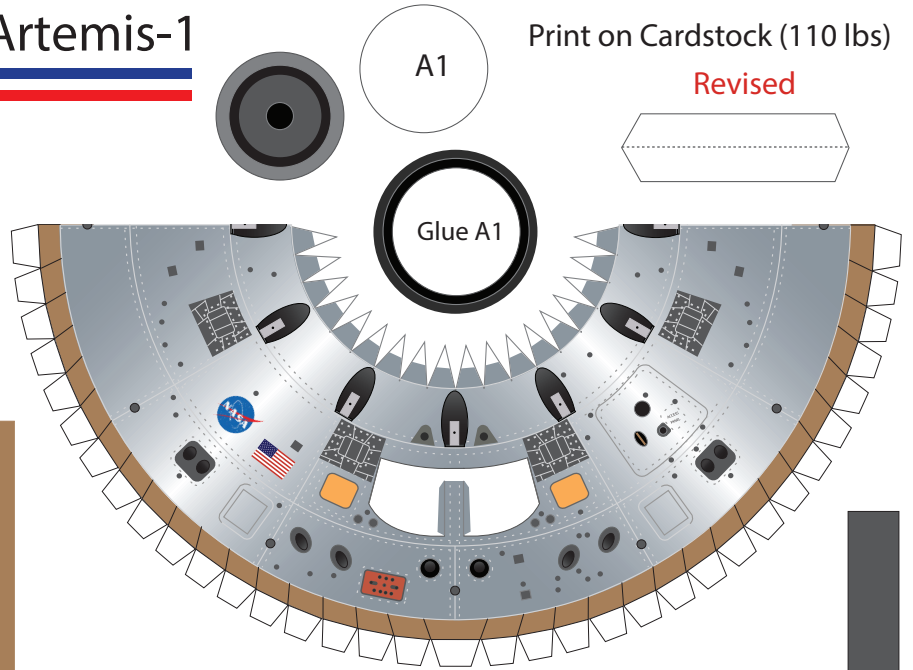



1 cm
1 inch

ORION Artemis-1

Print on Cardstock (110 lbs)

Revised

1:96 Scale

Top

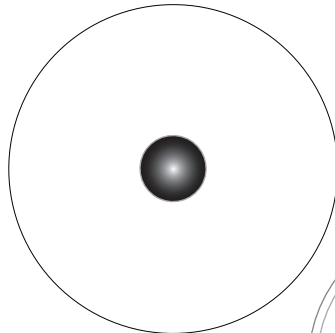
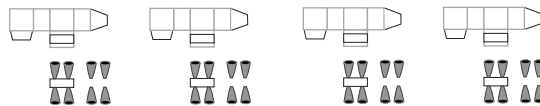
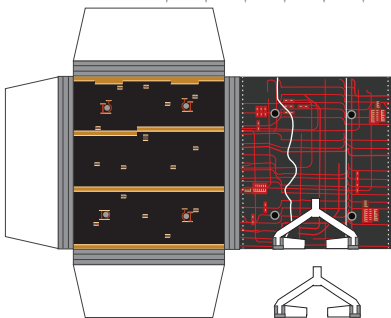
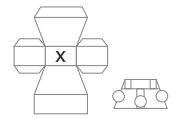
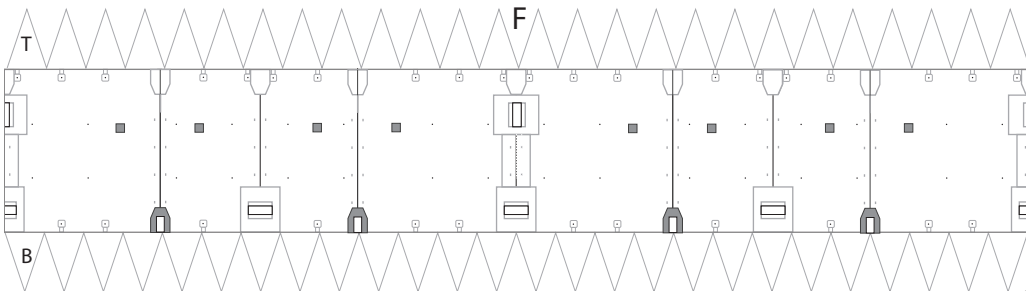
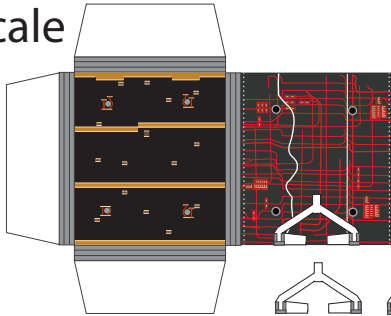
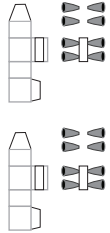
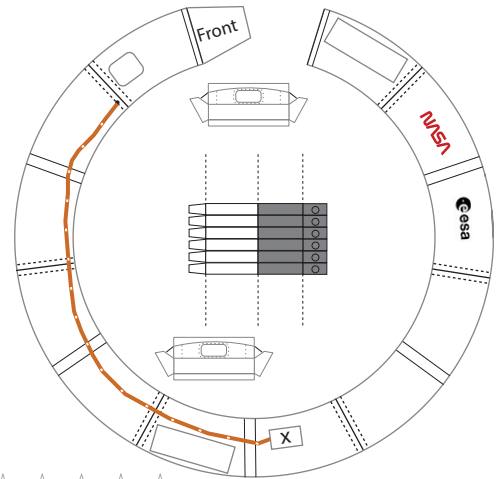
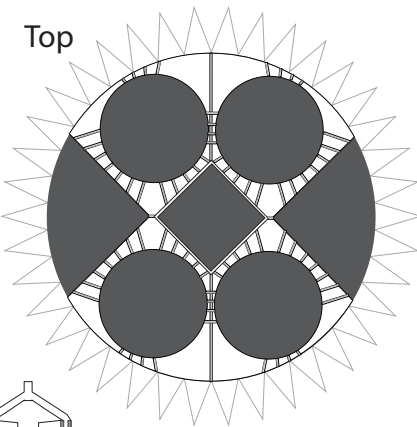

Front

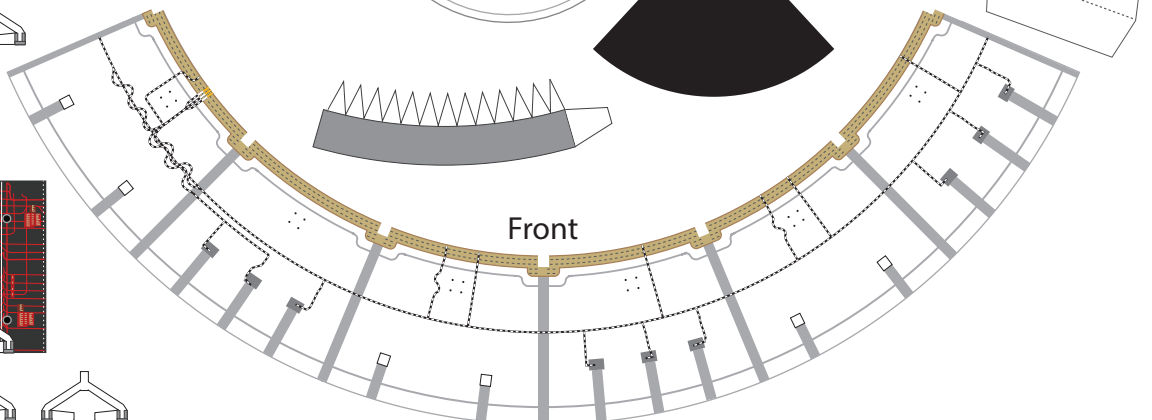
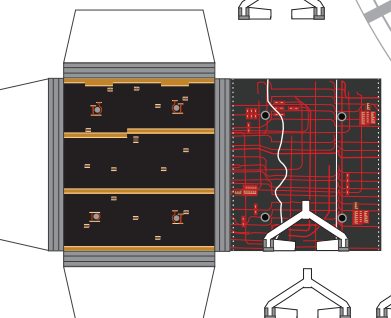
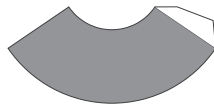
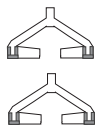
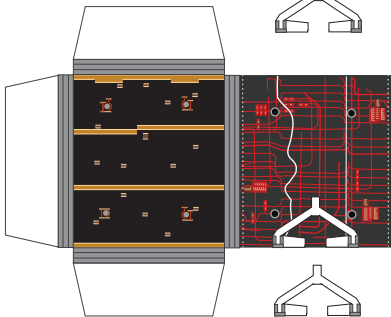
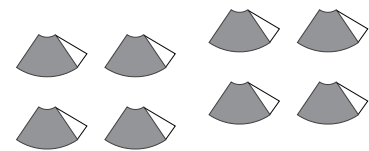
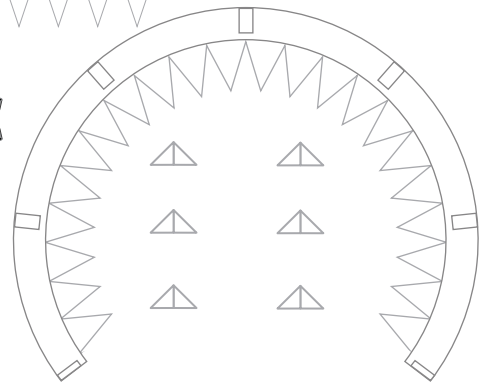
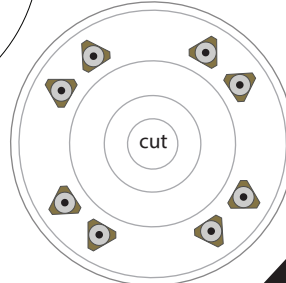



Back Print page

Service Module nozzles

1:96 Scale





Space Launch System (SLS)

Print on Cardstock (90 lbs)

ARTEMIS

Revised

Deployed Solar Panels

1:96 Scale

Back

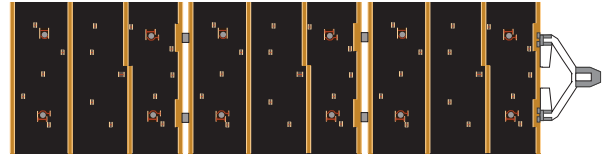
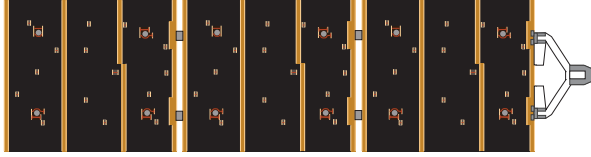

Front

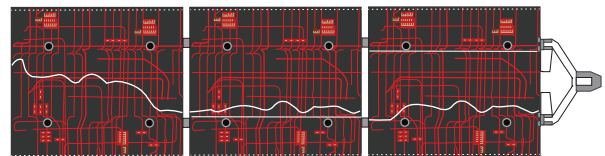
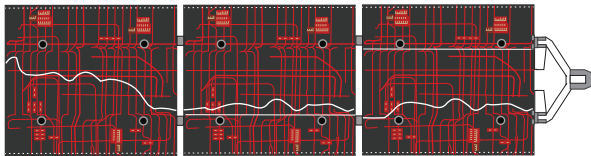
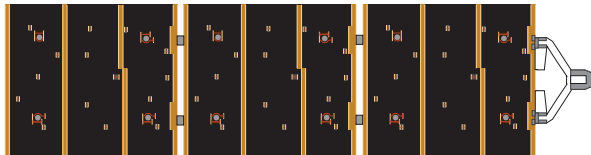
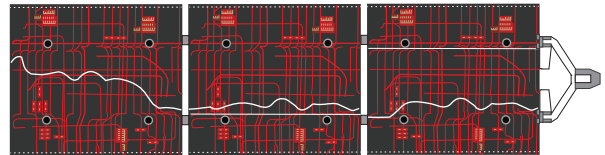
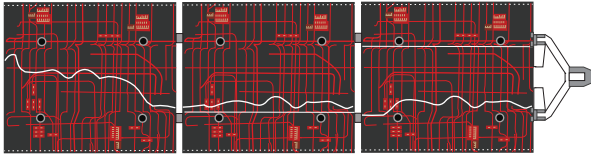

Extended Solar Panel configuration

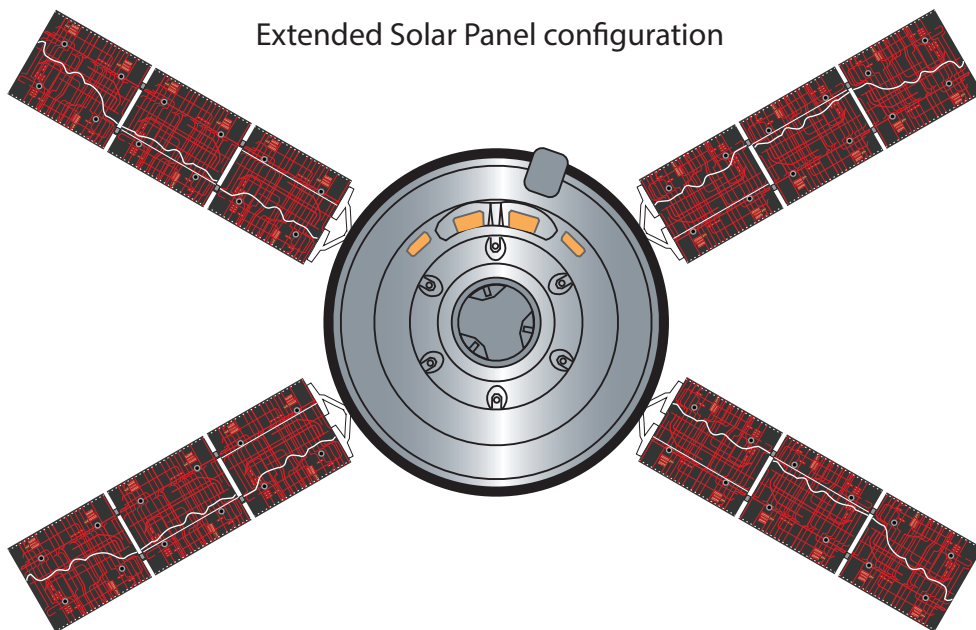



Space Launch System (SLS)

Print on Cardstock (110 lbs)

ARTEMIS

(Launch Configuration)



1:96 Scale

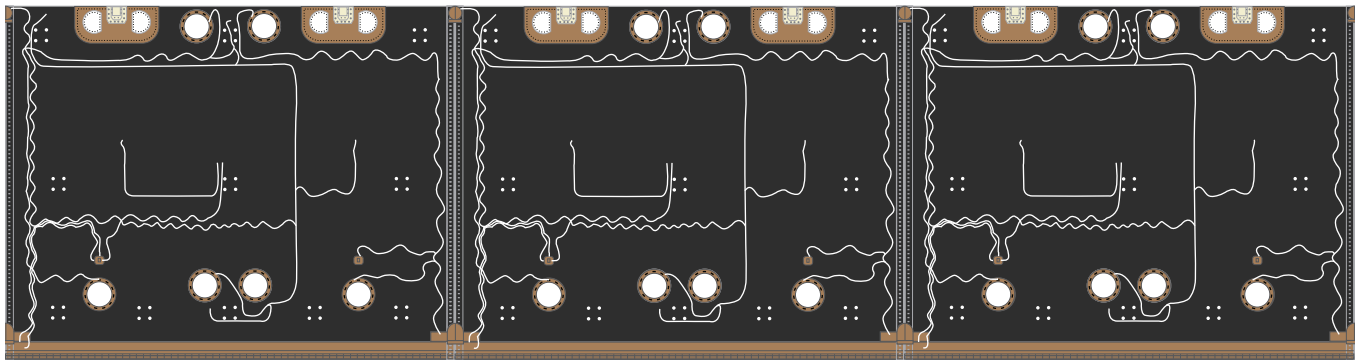
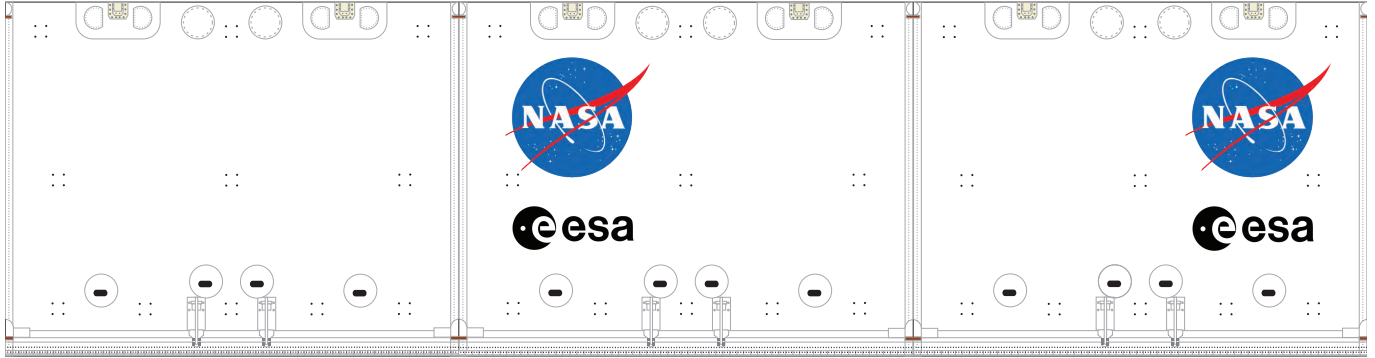

Connector between Service Module and Second Stage

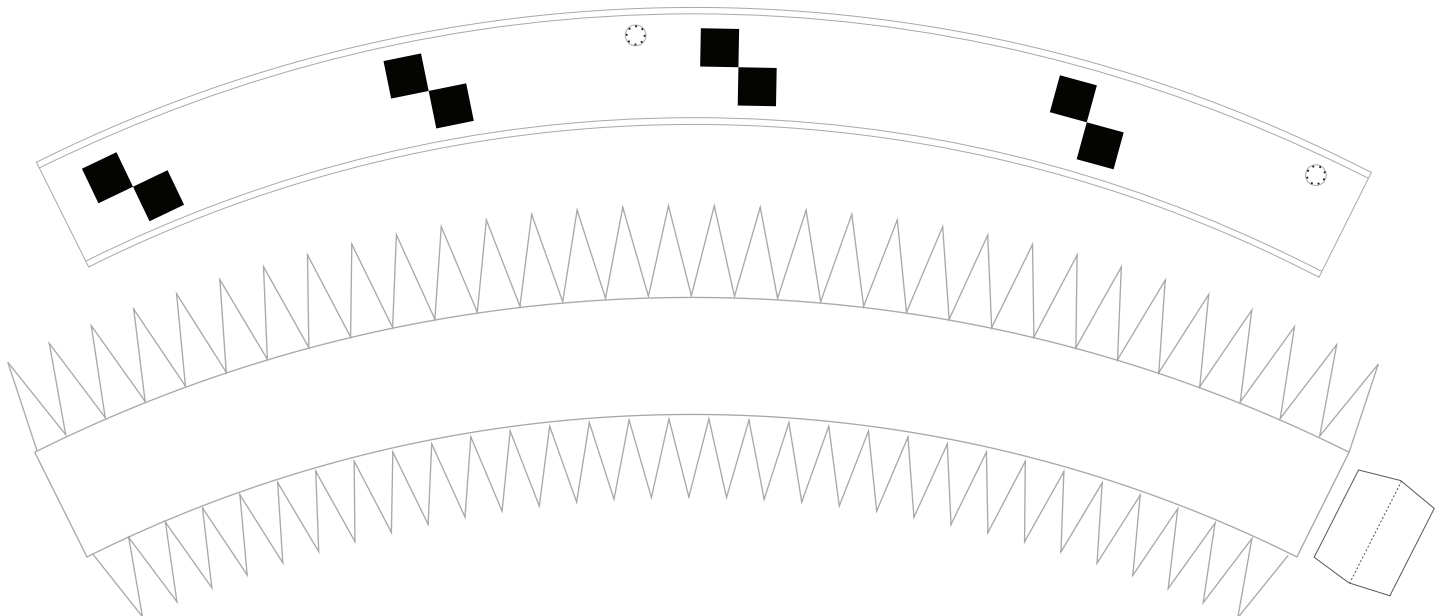



Space Launch System (SLS)

Print on Cardstock (110 lbs)

ARTEMIS

Service Module Fairing parts for Orbital configuration
(Fairing separation)

1:96 Scale

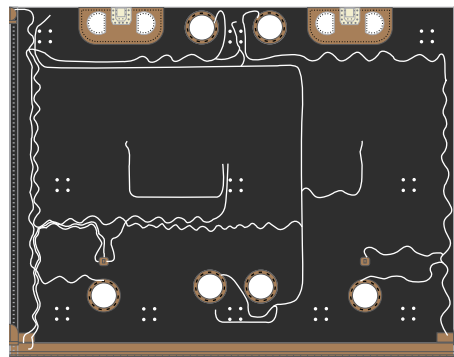
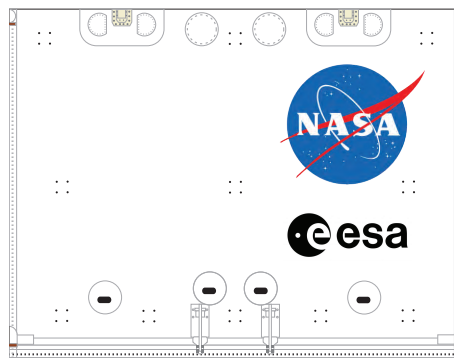
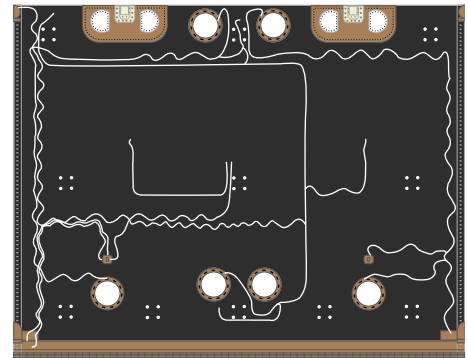
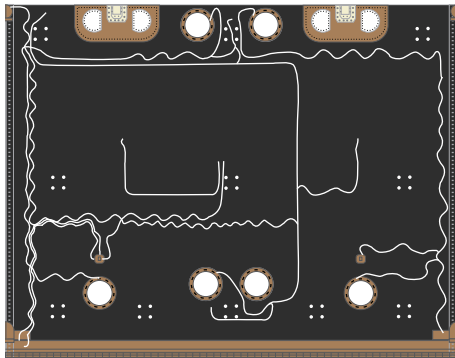
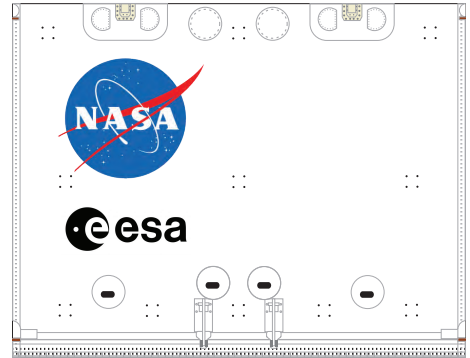
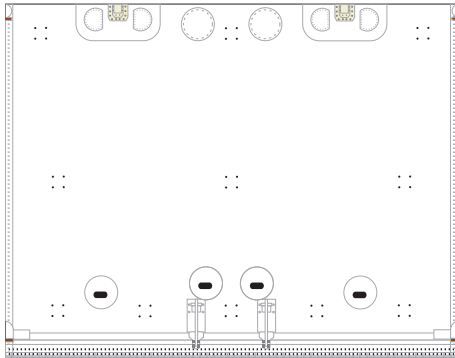



1 cm
1 inch

Space Launch System (SLS)

Print on Cardstock (110 lbs)

ARTEMIS

1:96 Scale

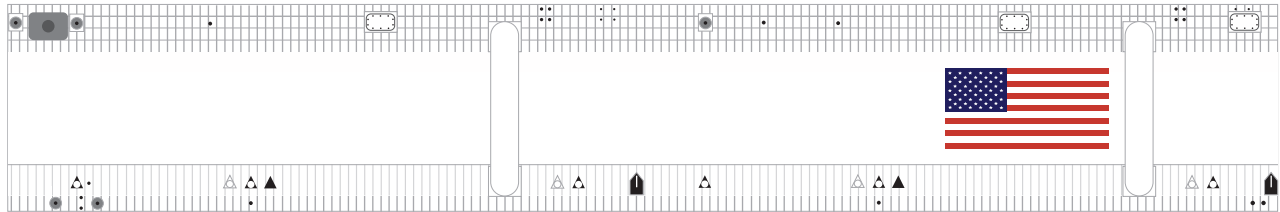

Fuel lines to upper dome

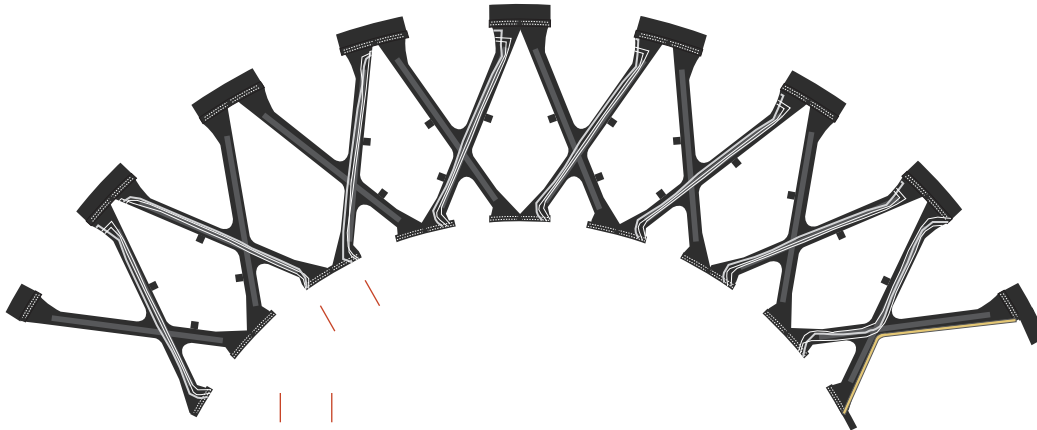

Fuel lines to lower dome

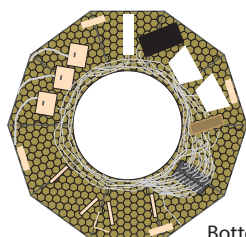
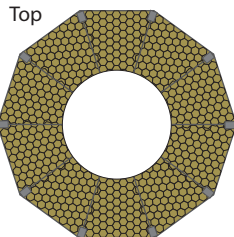
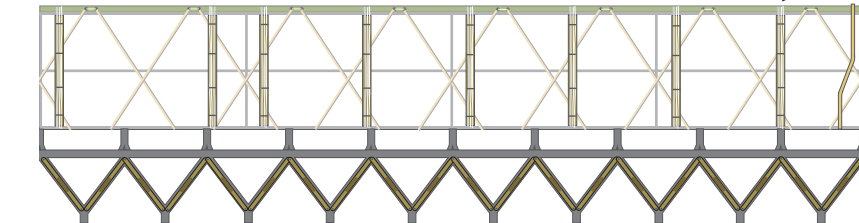

Bottom

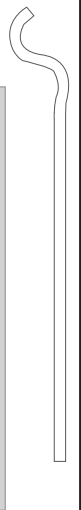
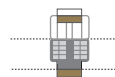
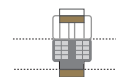
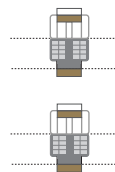
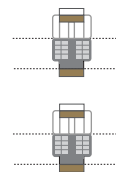
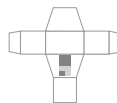
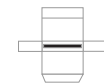
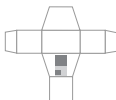
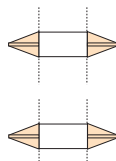
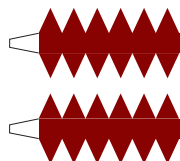

Tanks



Space Launch System (SLS)

Print on Cardstock (110 lbs)

ARTEMIS

1:96 Scale

Backside print for Second Stage X Pattern framework





Space Launch System (SLS)

Print on Cardstock (110 lbs)

ARTEMIS

Second Stage LH2 tank dome

1:96 Scale

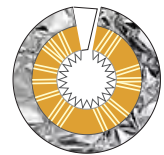
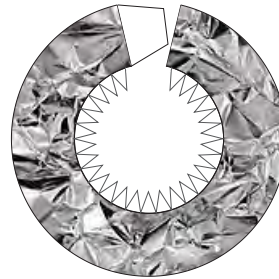
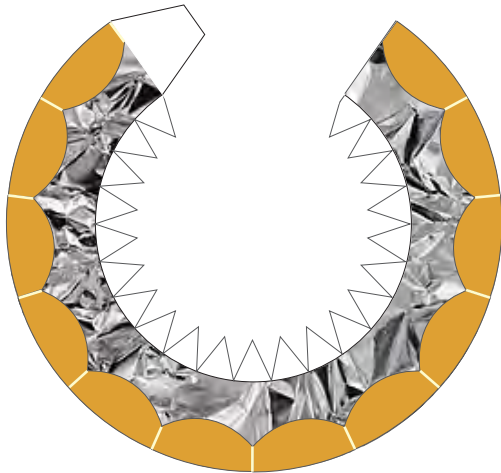
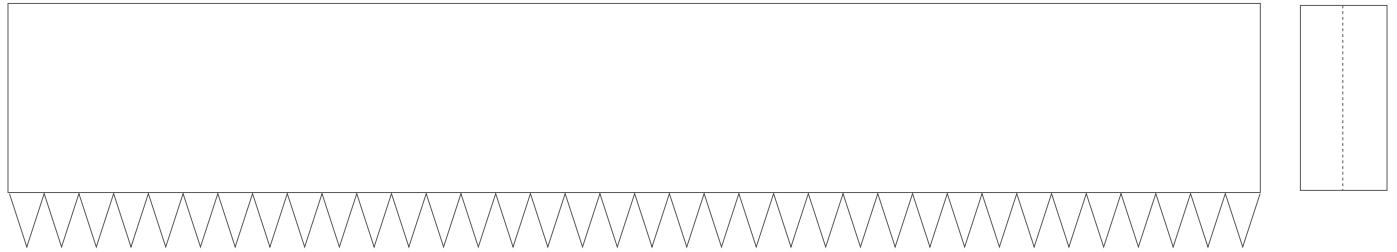

Diagram

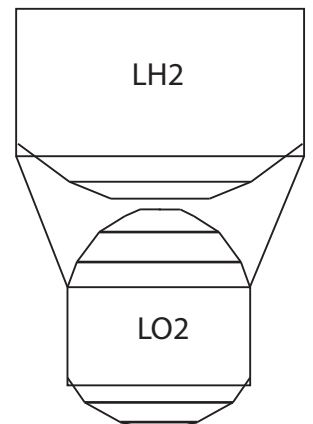



Space Launch System (SLS) ARTEMIS

Print on Cardstock (110 lbs)

Second Stage LO2 tank dome

1:96 Scale

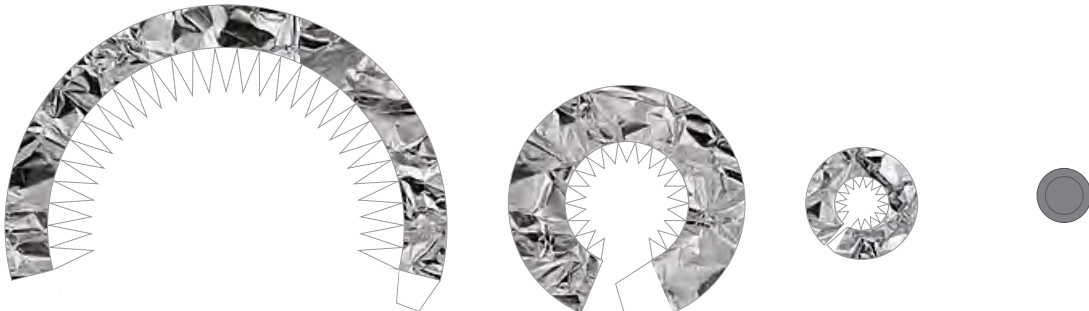
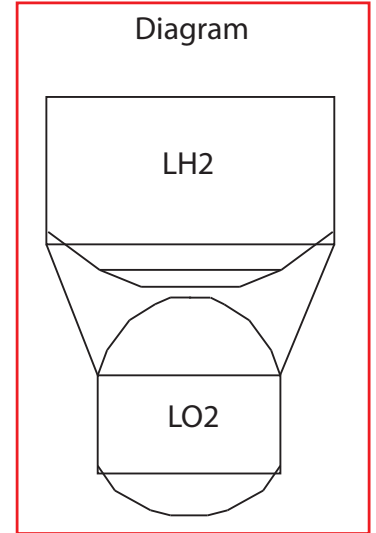
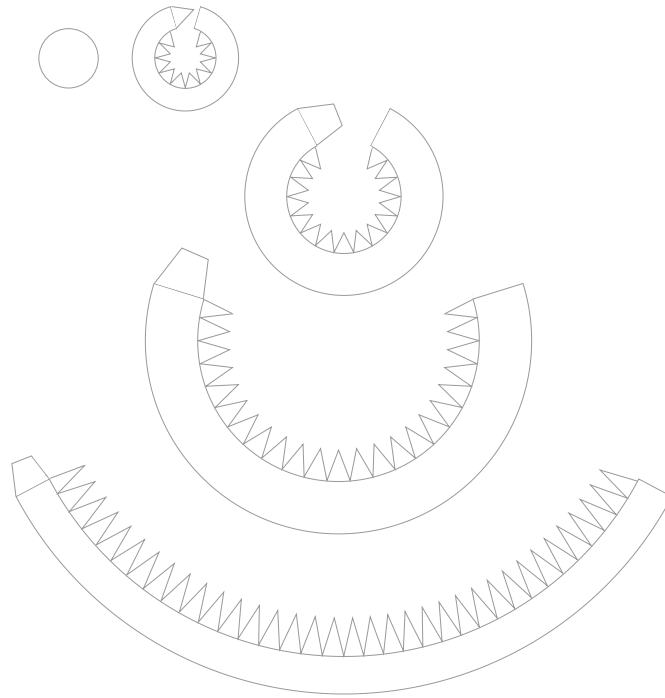



ARTEMIS

1:96 Scale

Diagram

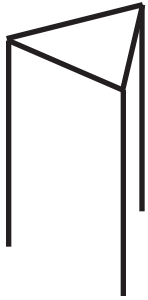

Exterior



Interior

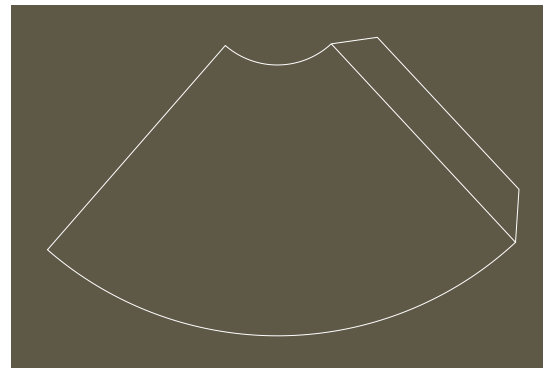
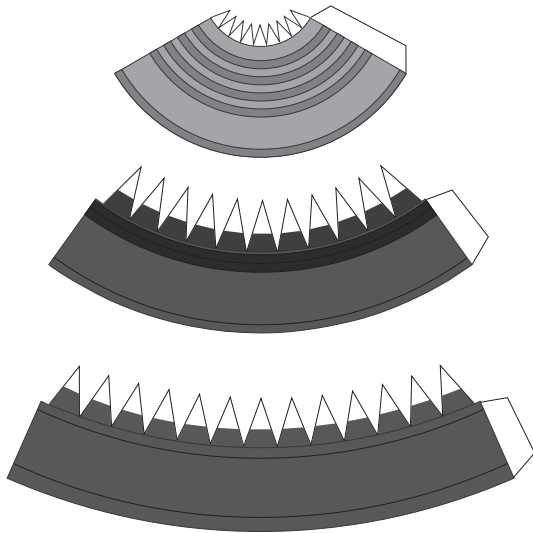
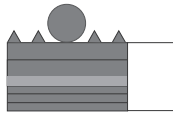

Pratt & Whitney RL10B-2 Engine