

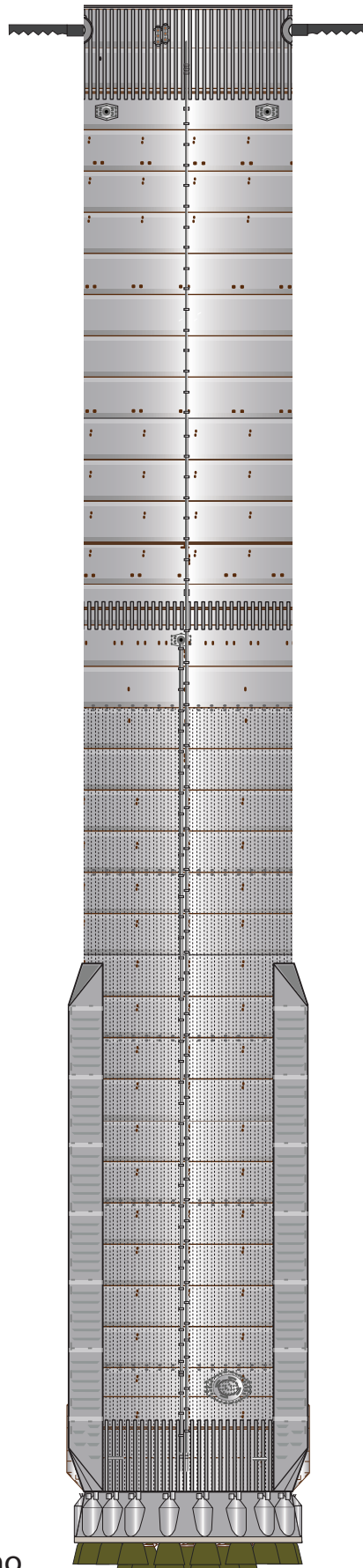

1:100 Scale

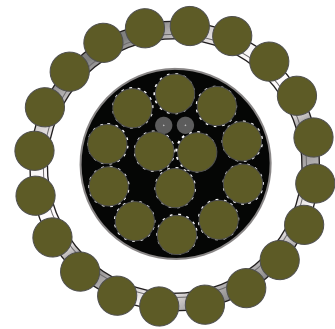

B7

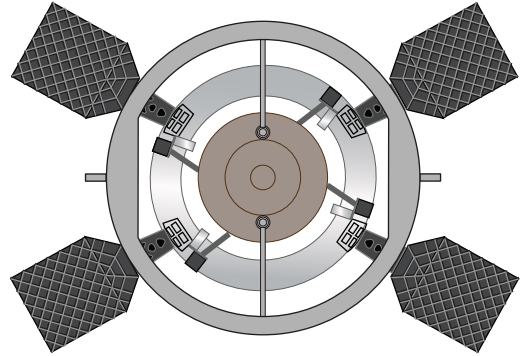

Designed by Alfonso X Moreno
©2022 Not for commercial use



SpaceX SuperHeavy

Print on Cardstock (110 lbs)

1:100 Scale

Top ring

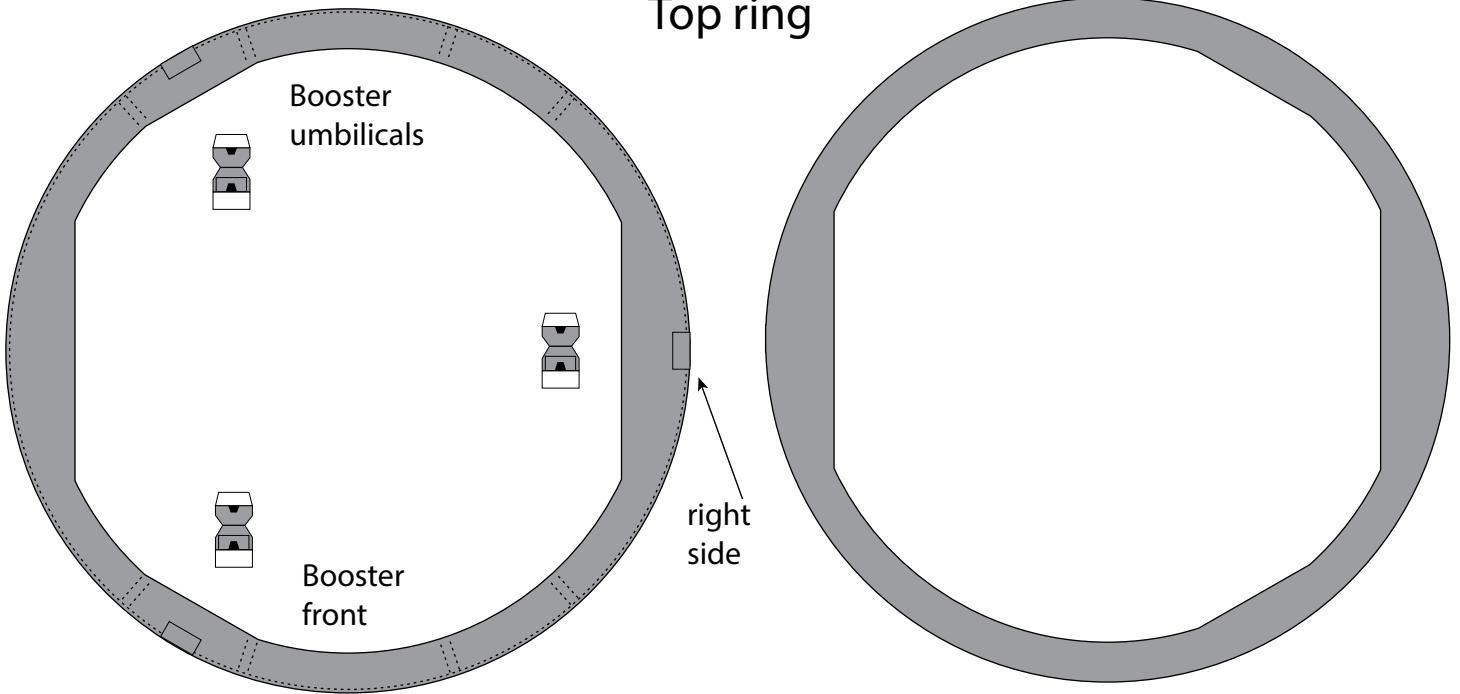

Bottom ring

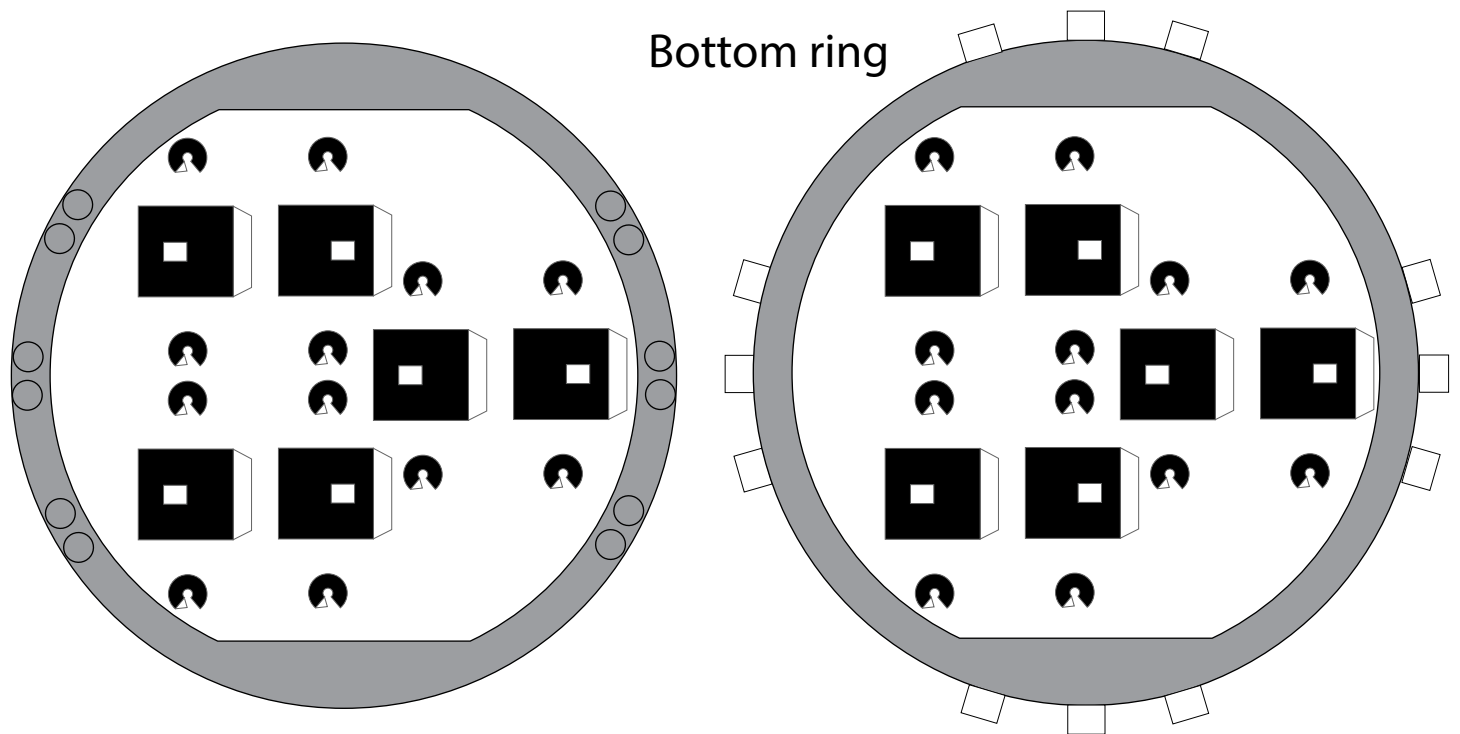

COPV pair
top and bottom supports



1 cm

1 inch

1:100 Scale

cut

SuperHeavy B7 Upper Dome

Print on Cardstock (110 lbs)

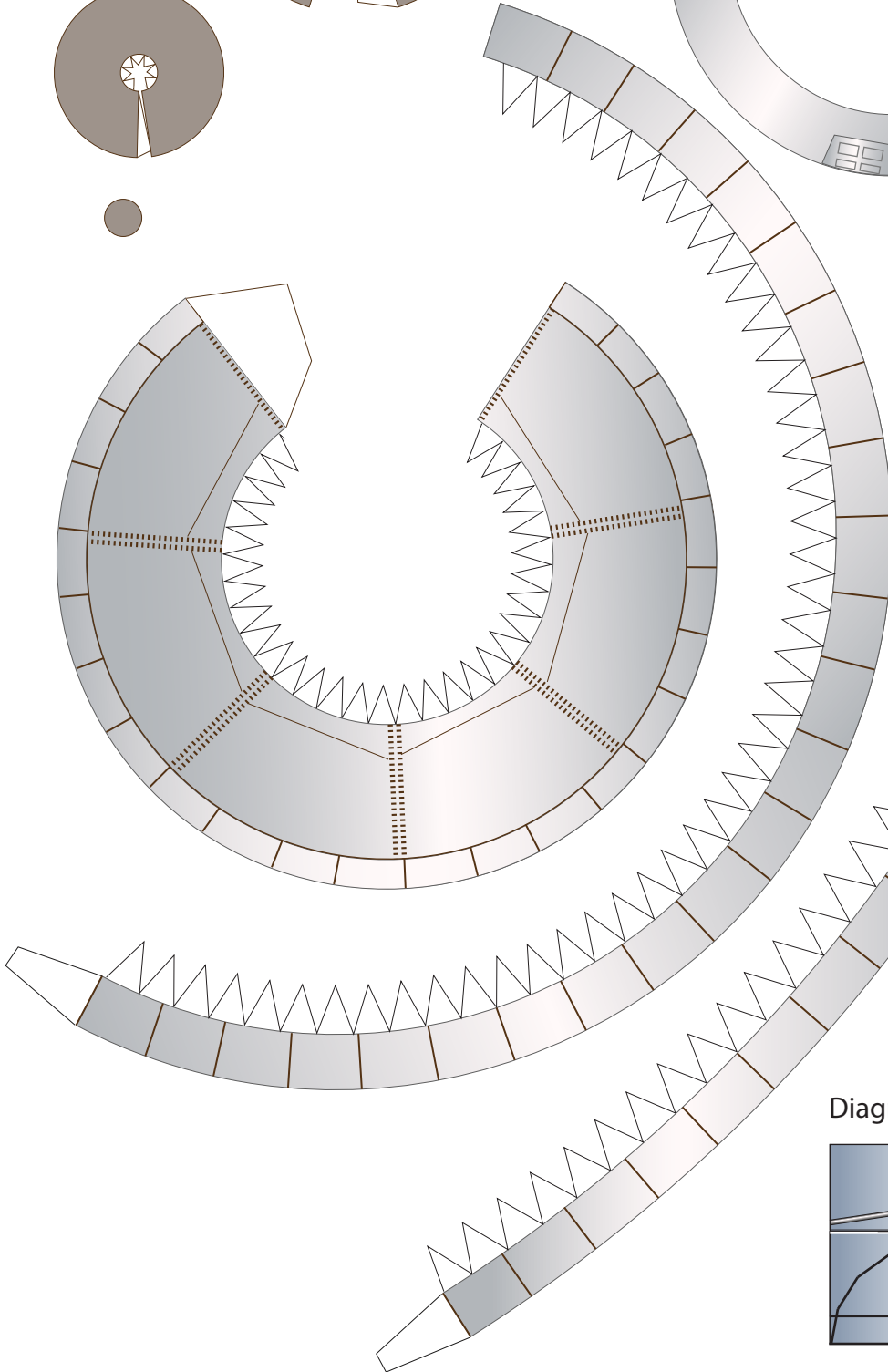
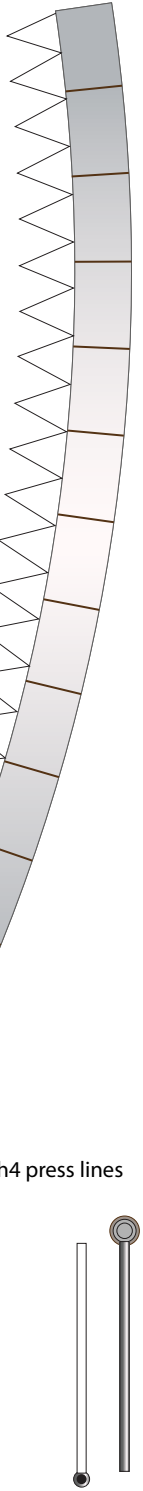
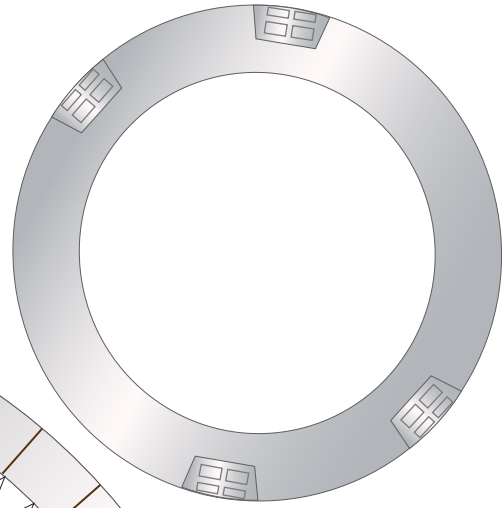
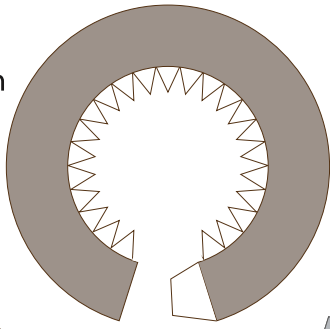
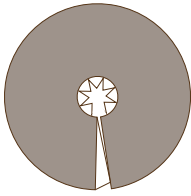

Ch4 press lines

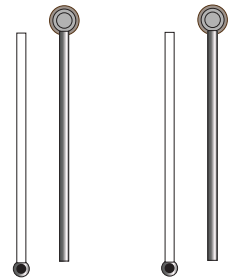

Diagram

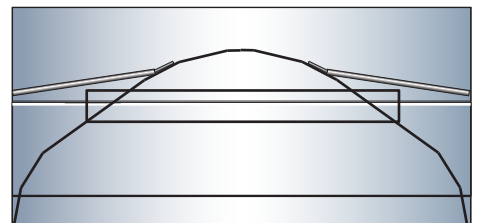



1 cm

SpaceX Starship B7

Print on Cardstock (110 lbs)

Grid Fins servo motors and Connectors for each body segment

1:100 Scale

1 inch

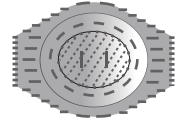
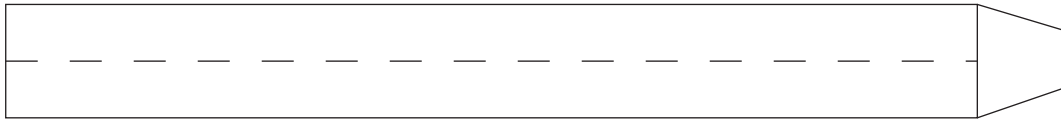
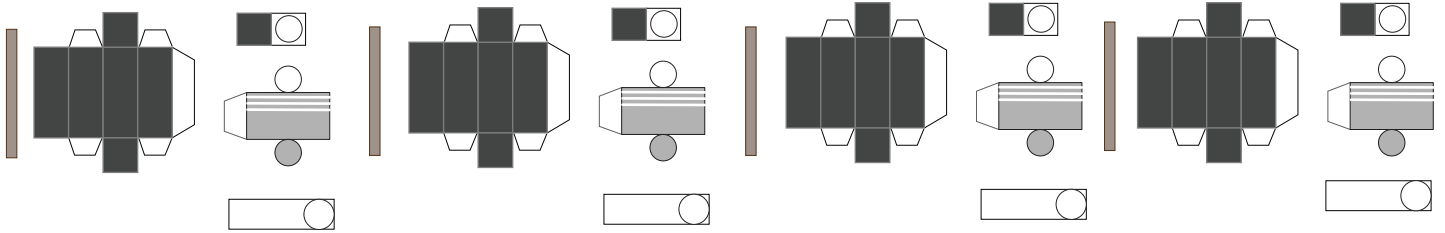

top/middle

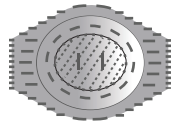
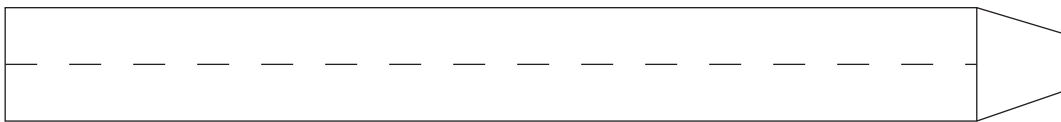
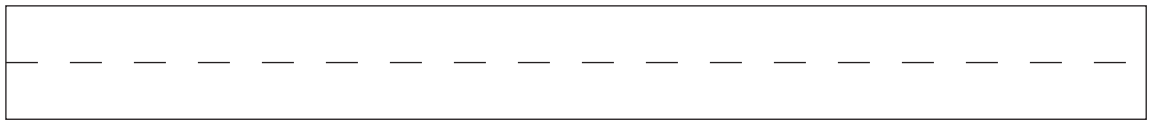

middle/bottom

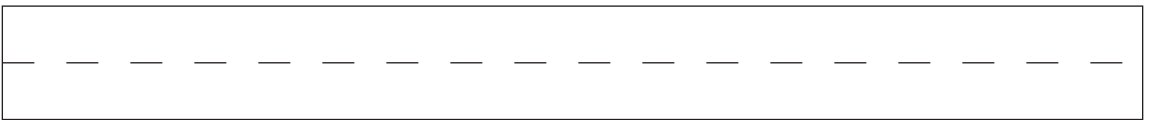

Glue tip of the
Ch4 press line to
cover the black circles

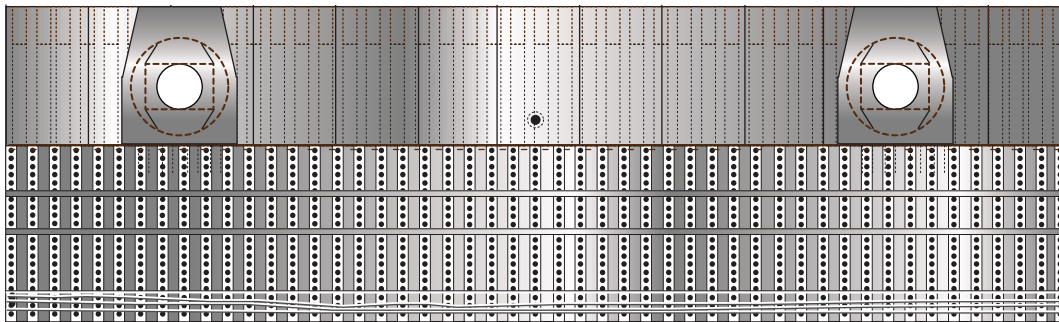

Interior wall
for upper dome
section

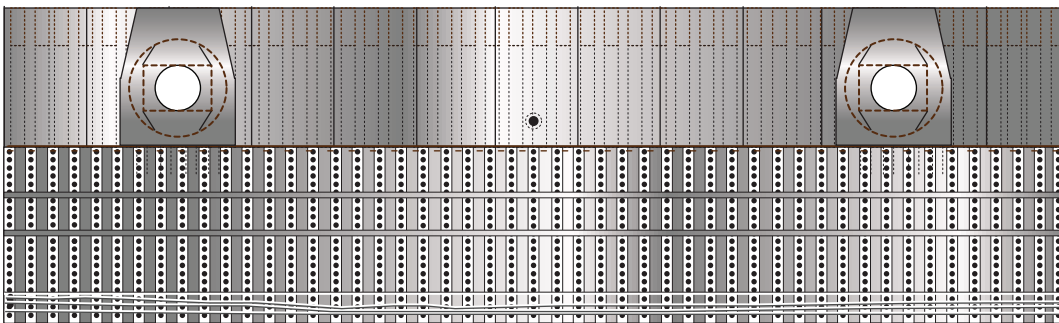



1 cm

1 inch

1:100 Scale

SuperHeavy B7 Grid Fins

Print on Cardstock (110 lbs)

Simple version

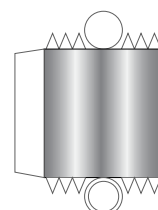
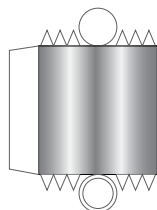
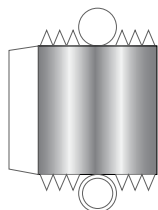
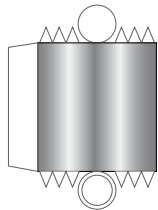
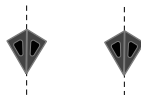
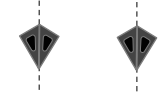
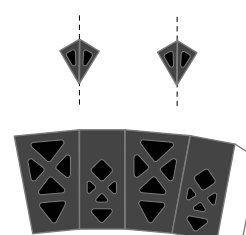
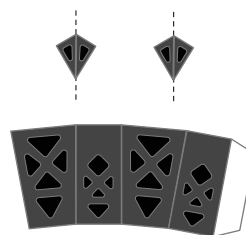
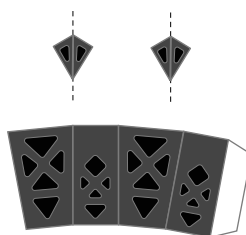
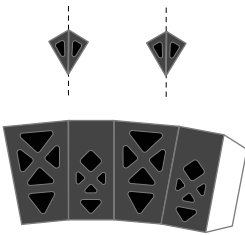
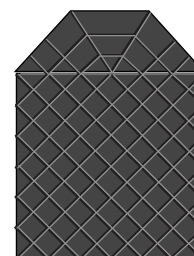
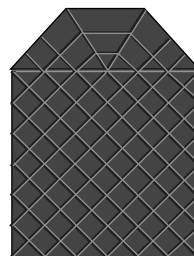
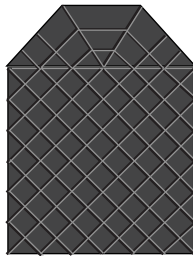
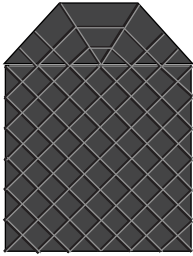
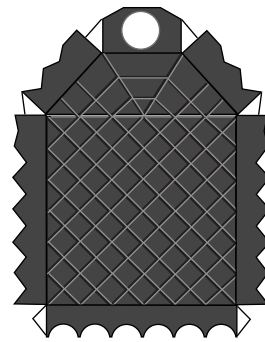
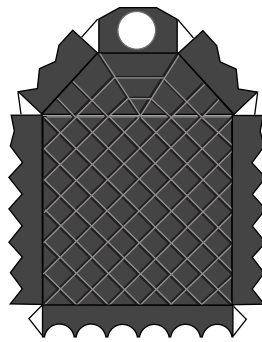
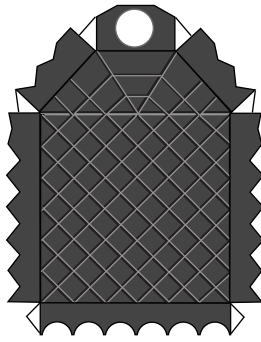
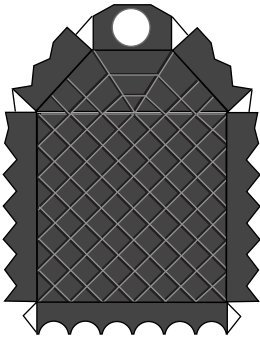



SuperHeavy BN-4 Grid Fins

Print on Cardstock (110 lbs)

Back Print

1:100 Scale





1 cm

1 inch

1:100 Scale

SuperHeavy B7 Grid Fins

Print on Cardstock (110 lbs)

Detailed version

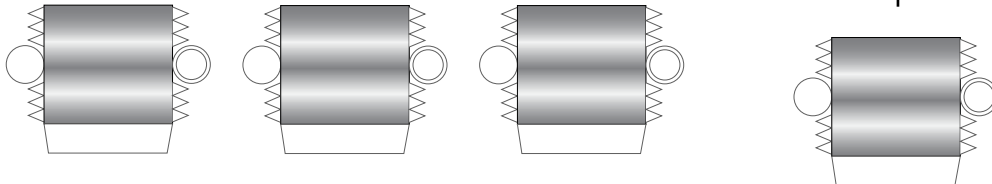
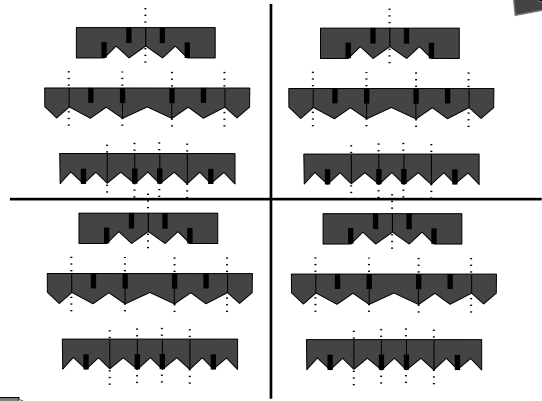
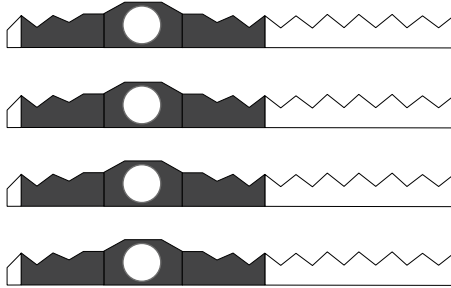
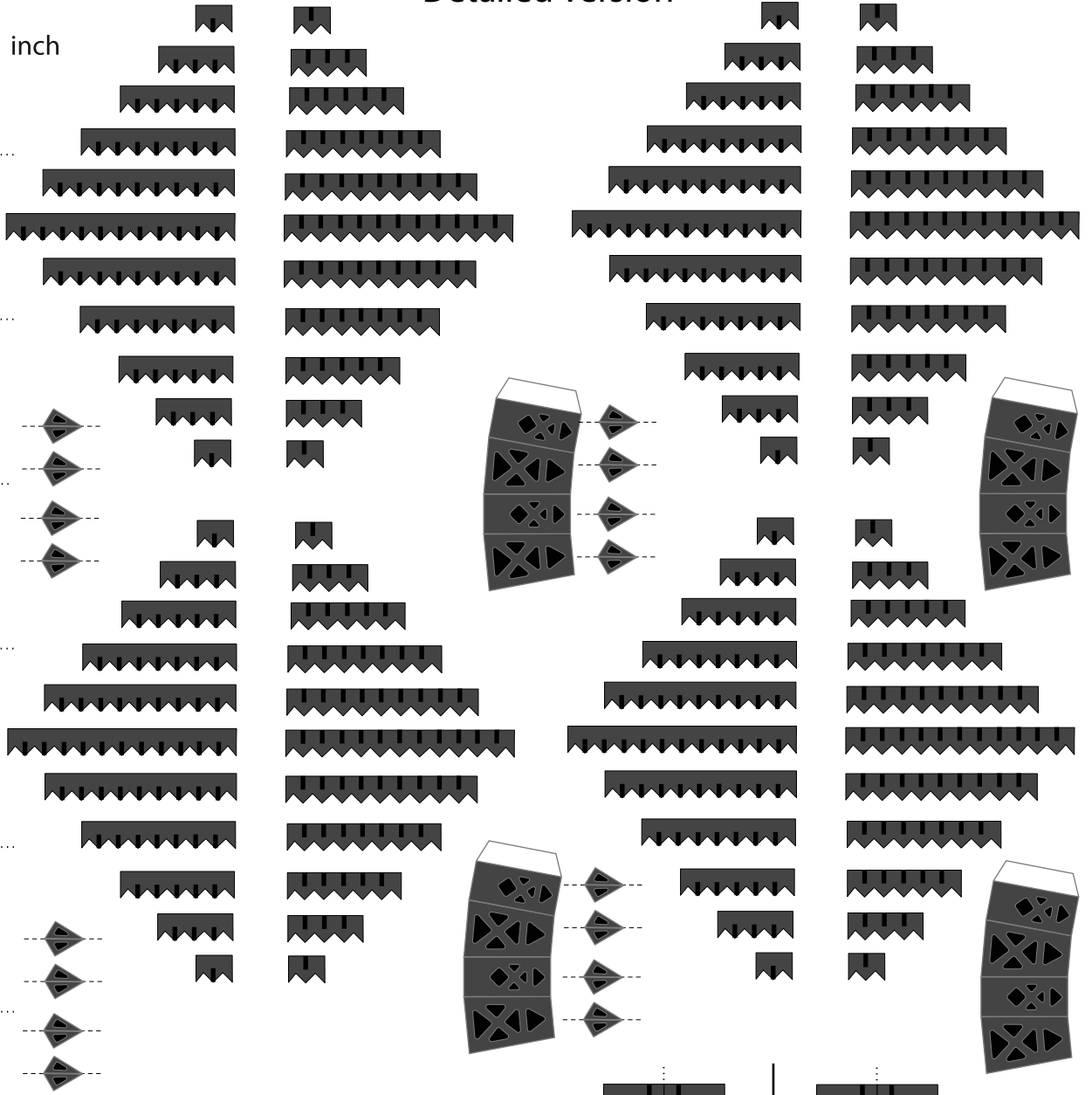
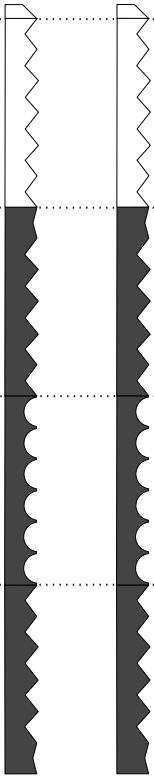



SuperHeavy BN-4 Grid Fins

Print on Cardstock (110 lbs)





1:100 Scale



Booster 7

Print on Cardstock (110 lbs)

Belly side top

Updated

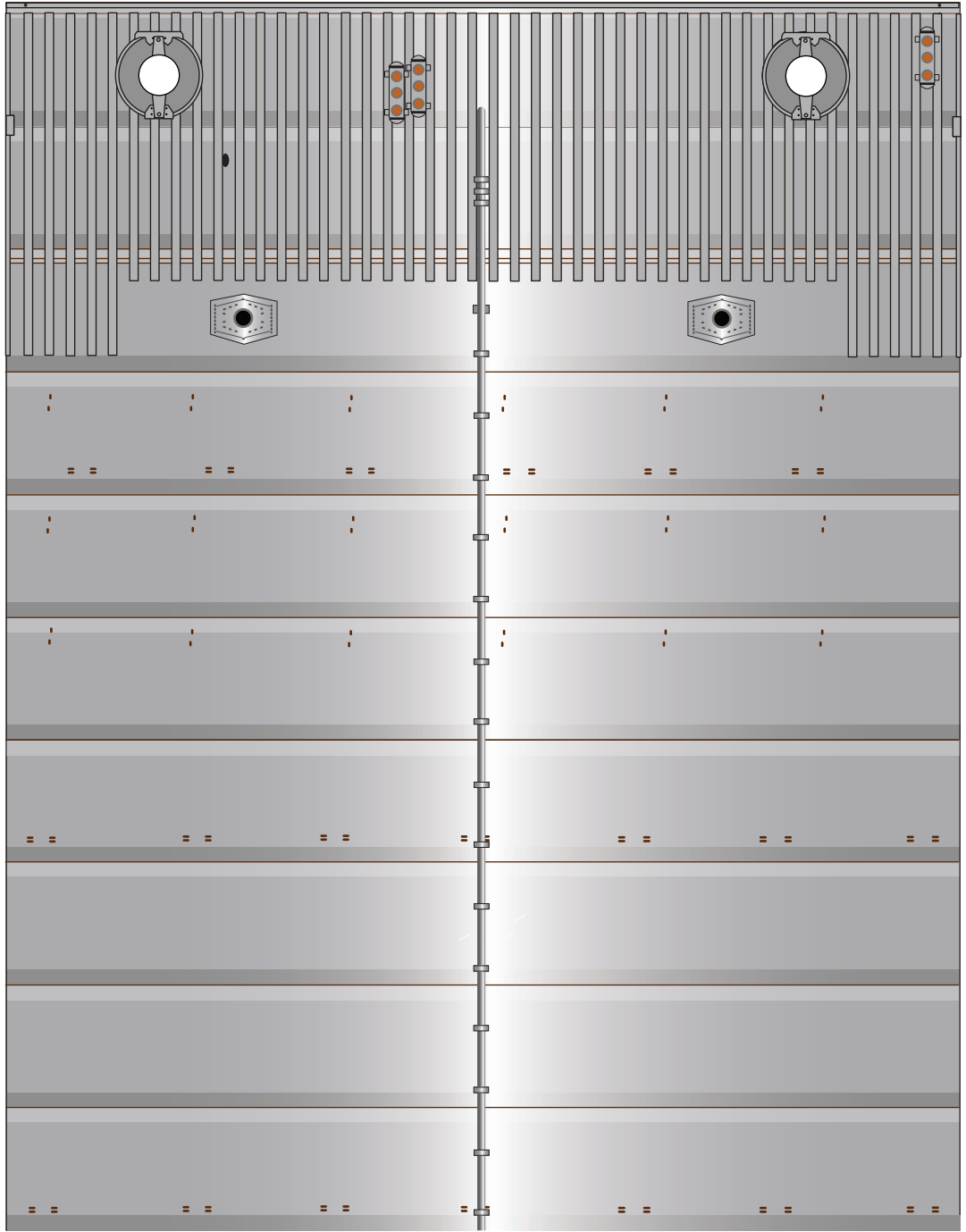
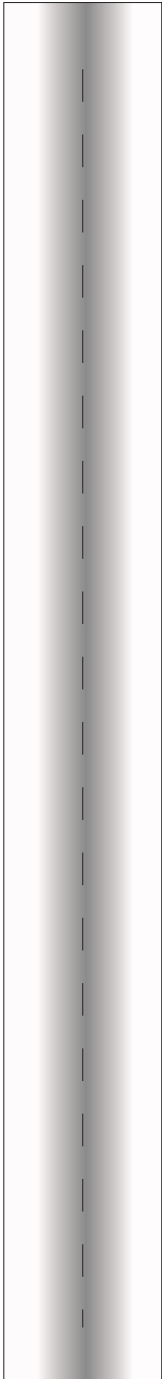
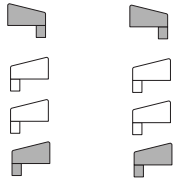



1:100 Scale



Booster 7

Print on Cardstock (110 lbs)

Back side top

Updated

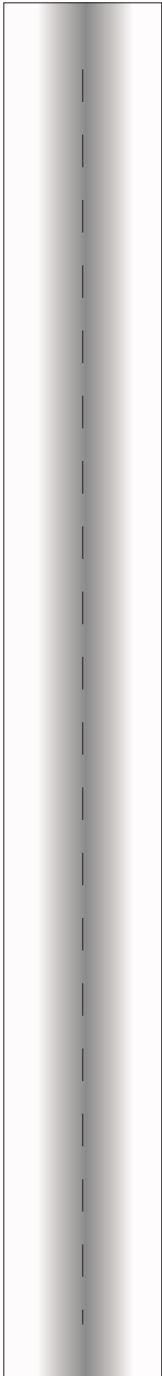



1:100 Scale

Booster 7

Print on Cardstock (110 lbs)

Belly side middle

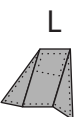
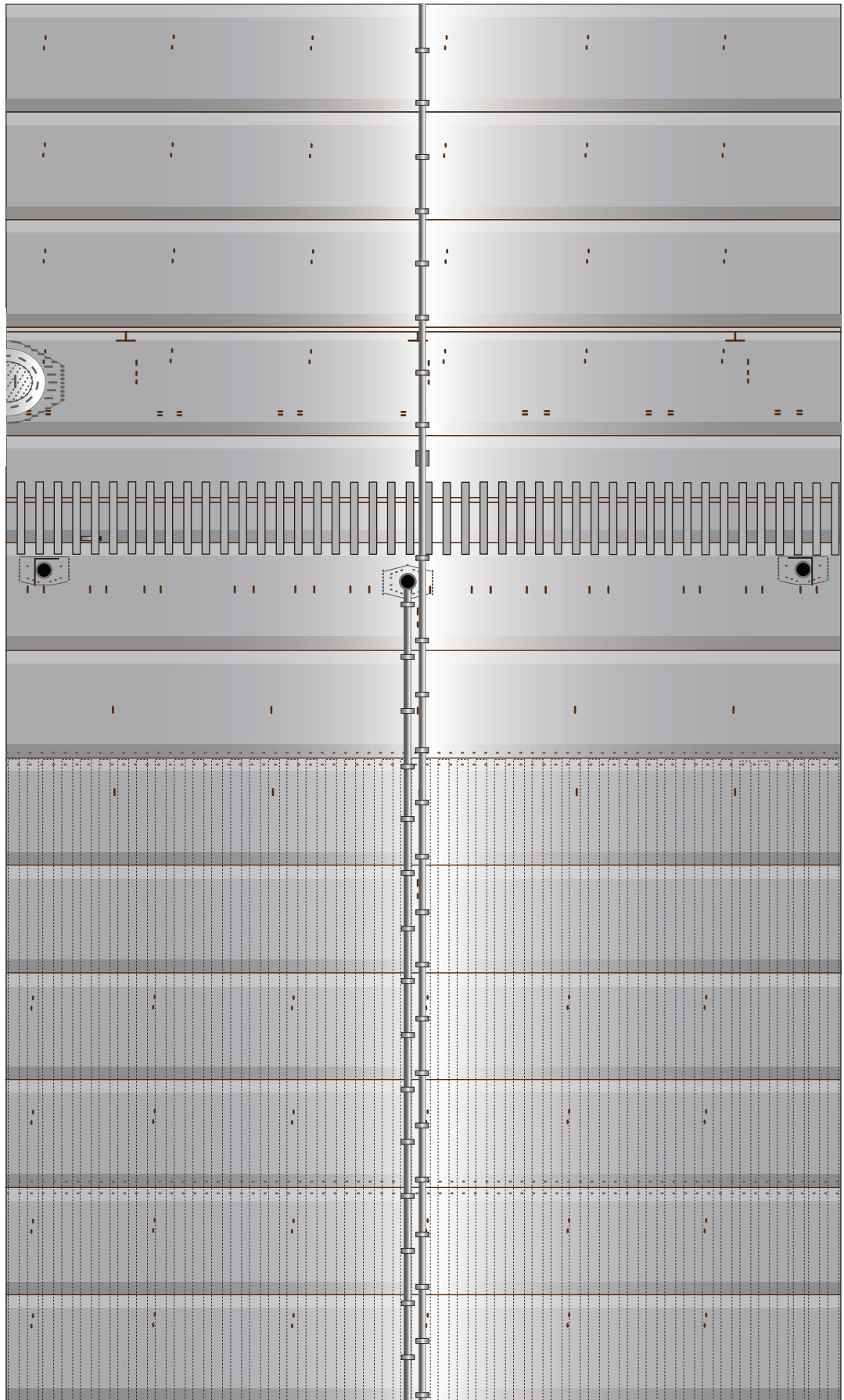
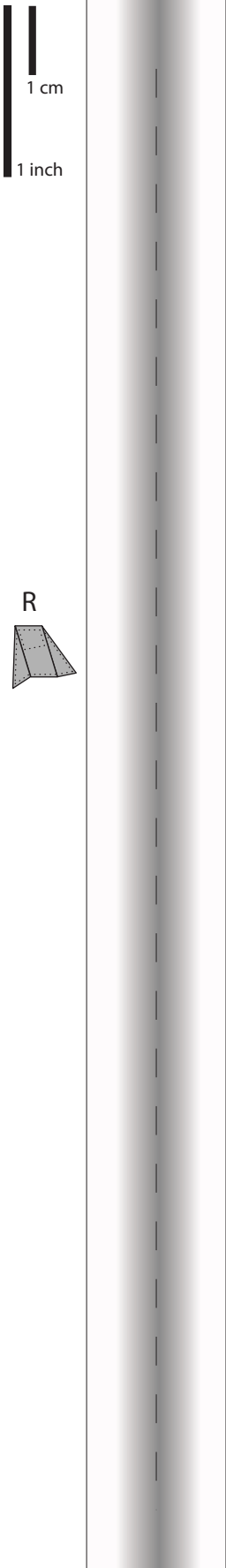



1:100 Scale

Booster 7

Print on Cardstock (110 lbs)
Back side middle

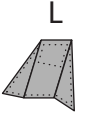
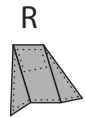



1:100 Scale

Booster 7

Print on Cardstock (110 lbs)

Belly side bottom

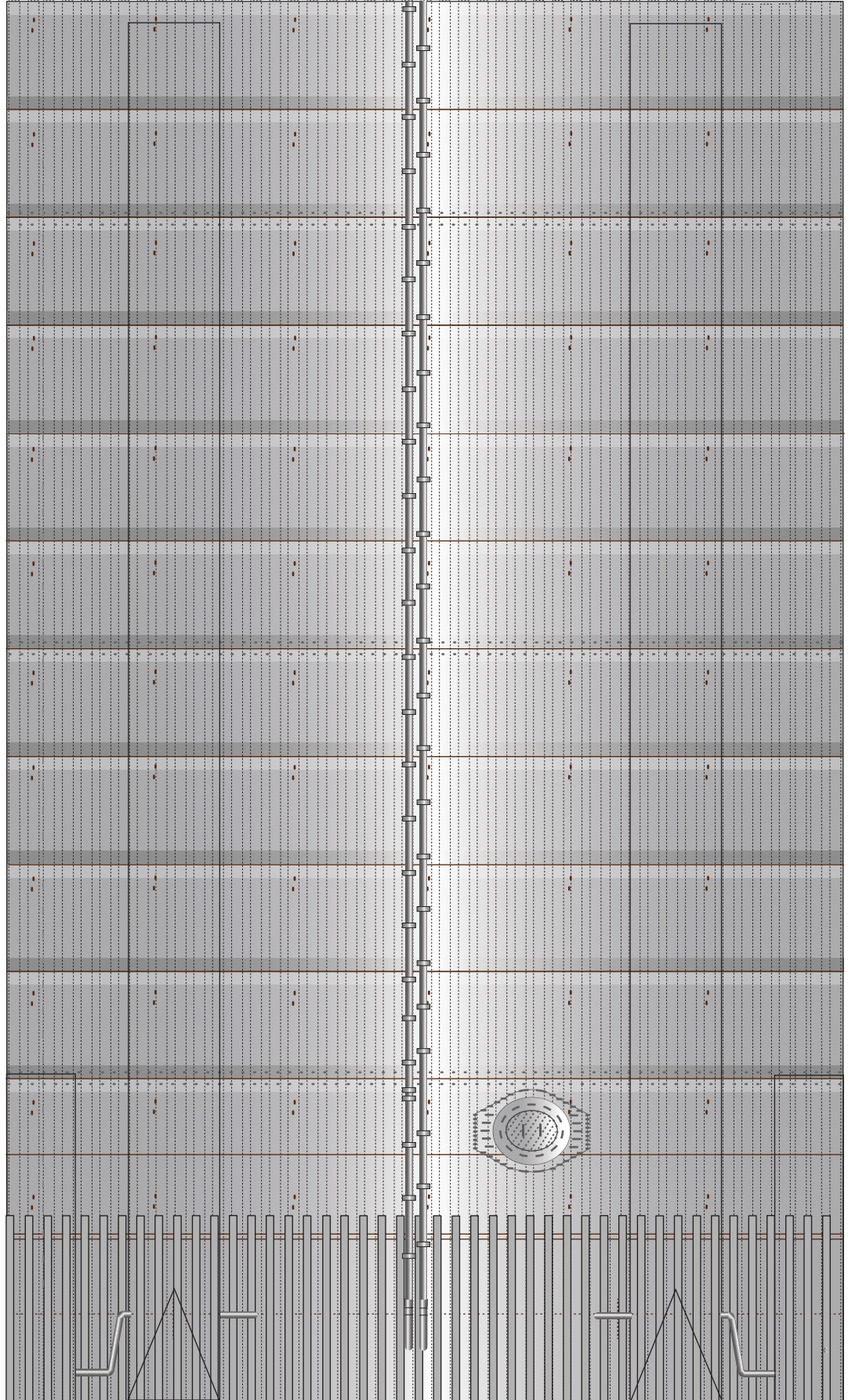
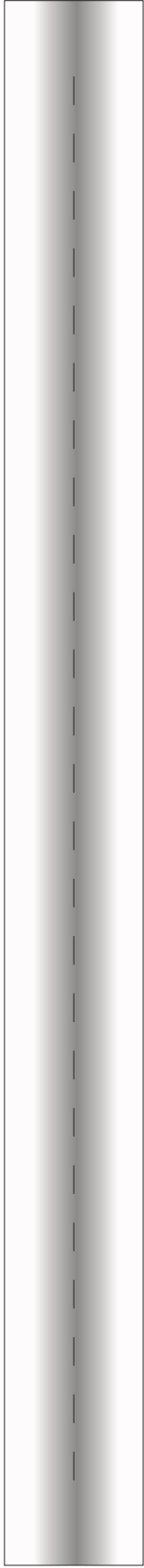



1:100 Scale

Booster 7

Print on Cardstock (110 lbs)
Back side bottom

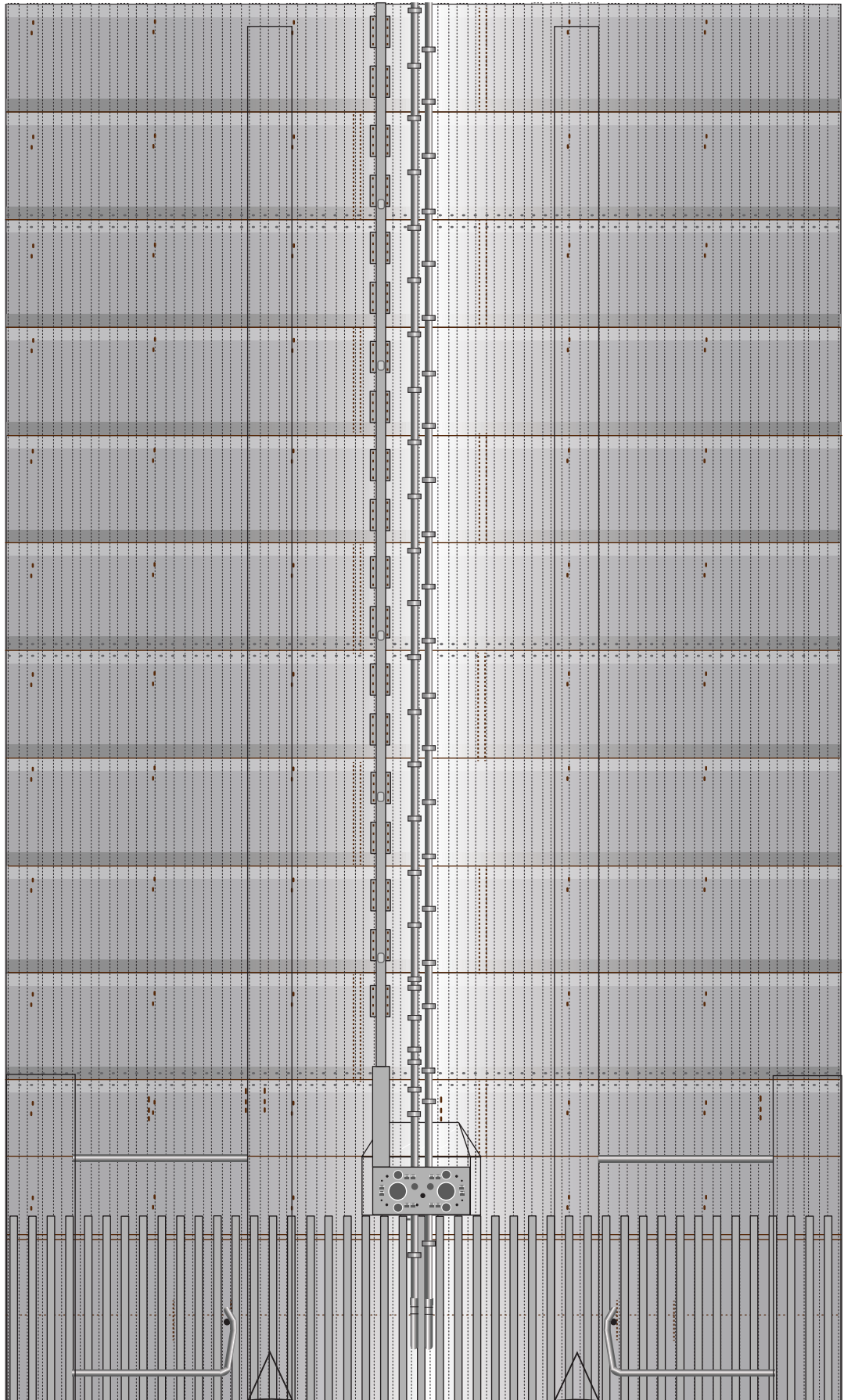
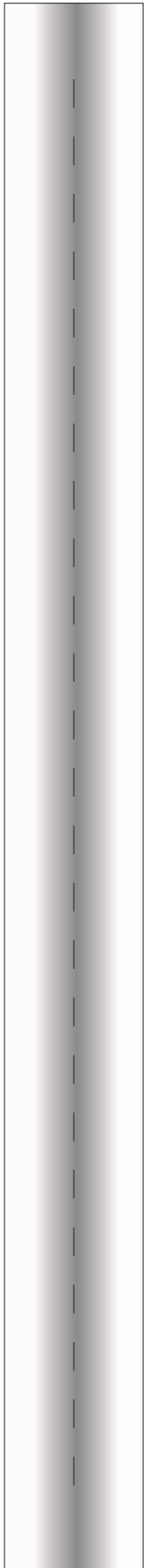



1 cm

1 inch

1:100 Scale

SpaceX Heavy booster 7

Print on cardstock (110 lbs)

COPV covers

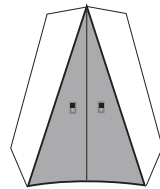
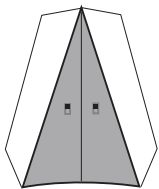
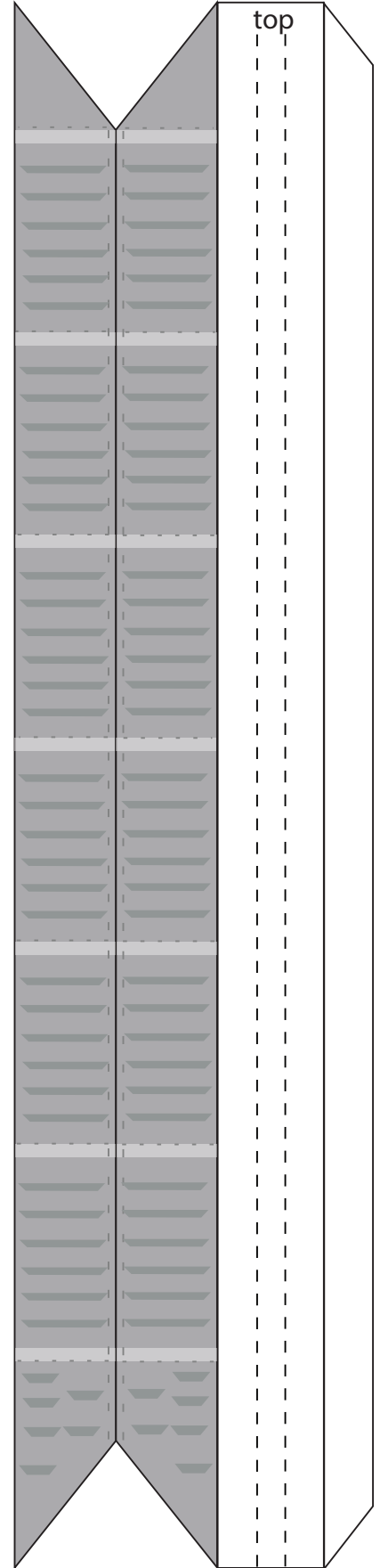
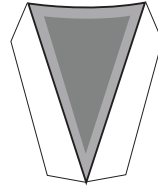
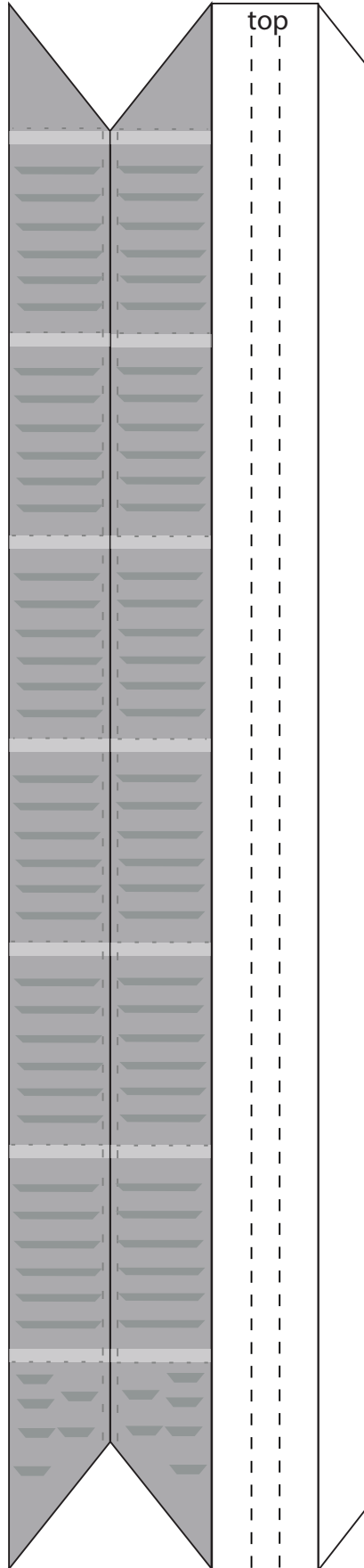
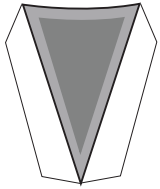



1:100 Scale



SpaceX Heavy booster 7

Print on cardstock (110 lbs)

Small covers

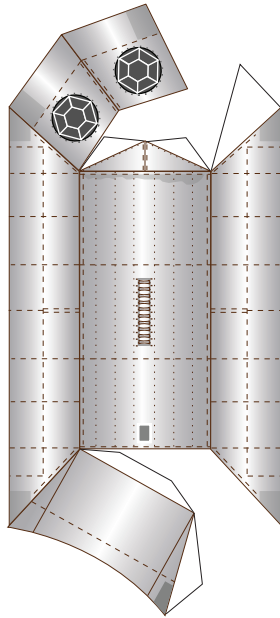
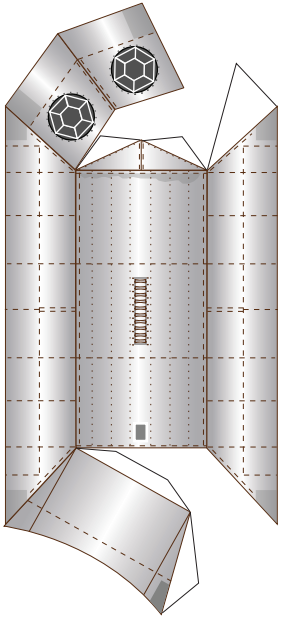
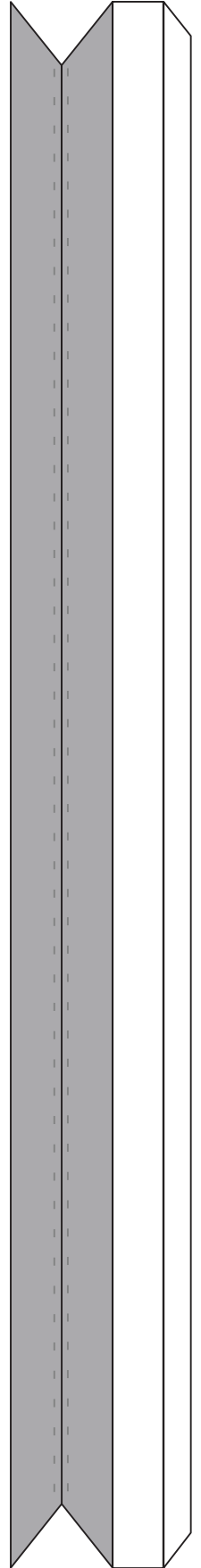
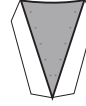
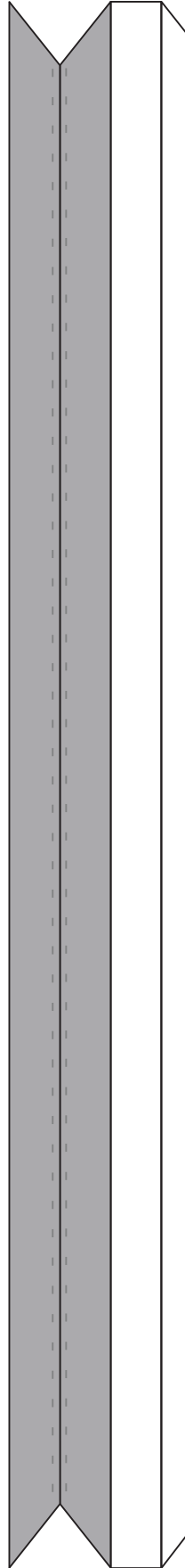
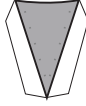

Booster Quick Disconnect

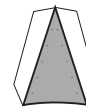
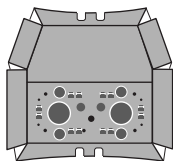



1:100 Scale



SpaceX Starship BN-4

Print on Cardstock (110 lbs)

Formers for top section

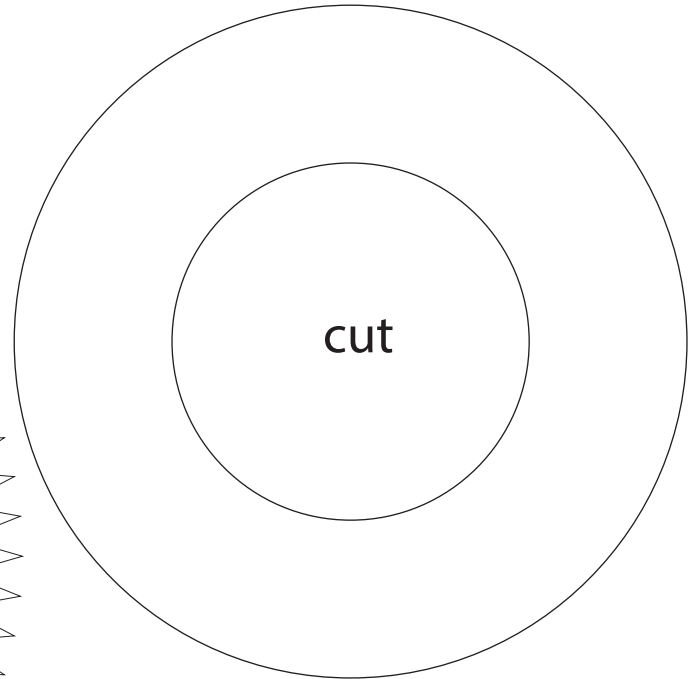
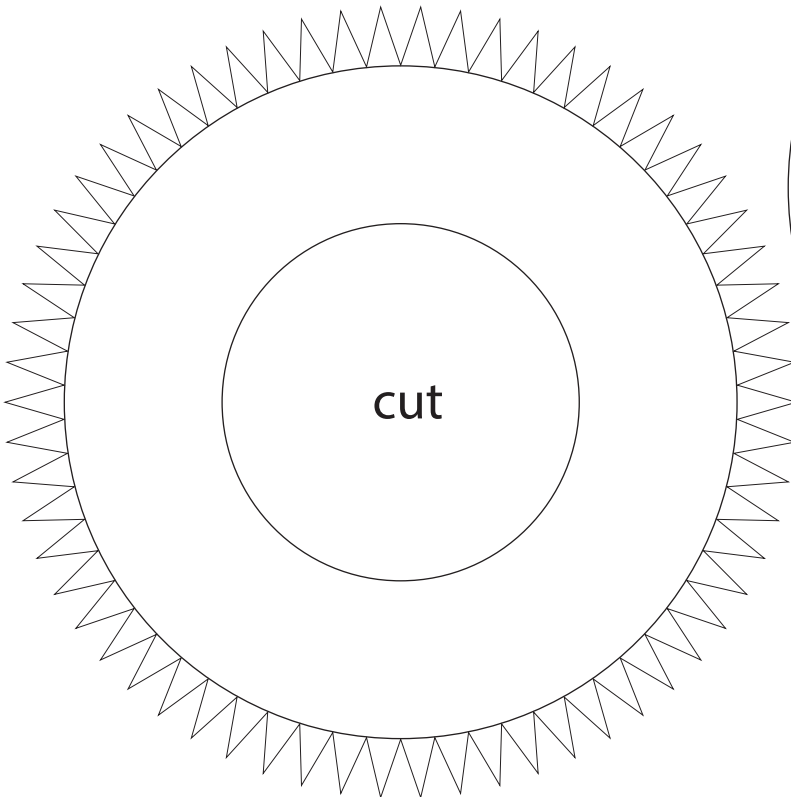
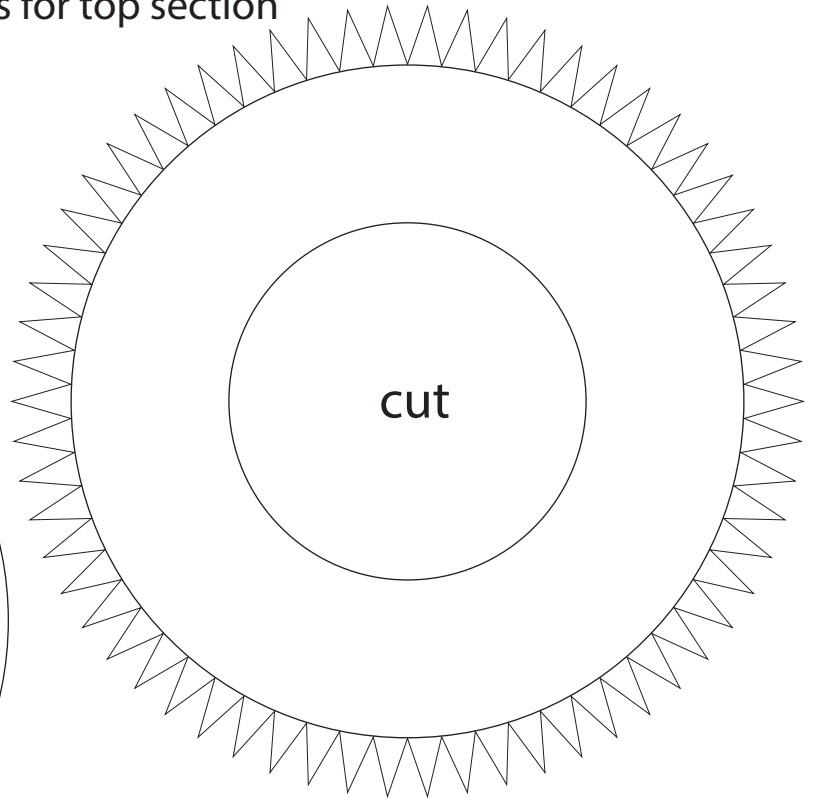
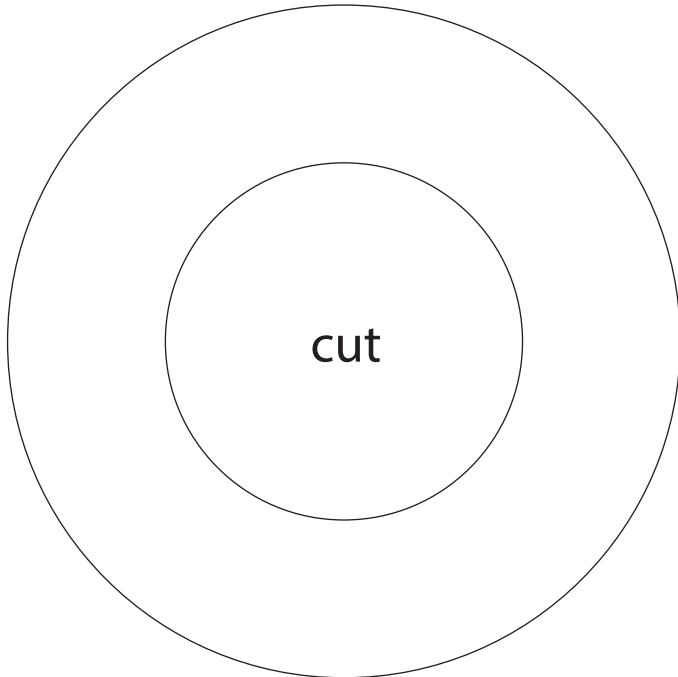

IMPORTANT
Top former is glued 42 mm from top edge of top booster section.
Bottom former is glued 20 mm from bottom edge of top booster section.



1:100 Scale

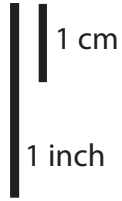

SpaceX Starship BN-4

Print on Cardstock (110 lbs)

Formers for middle body

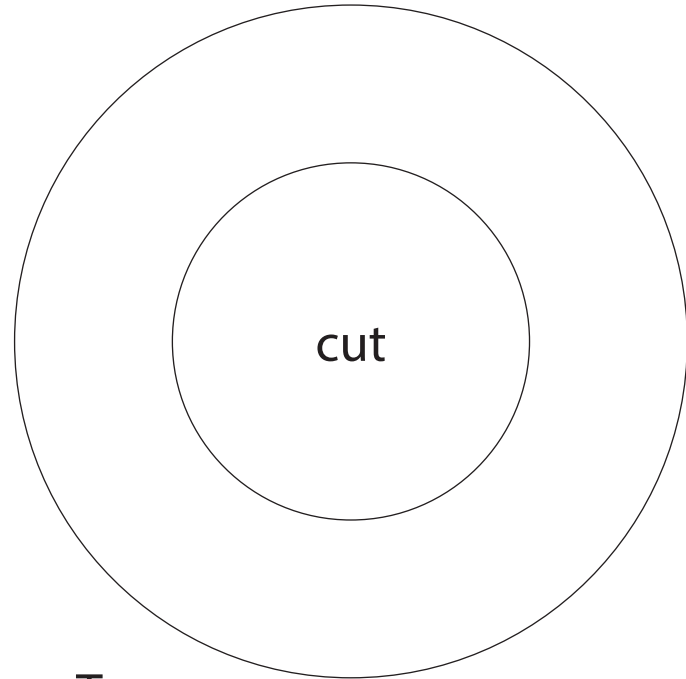

Top

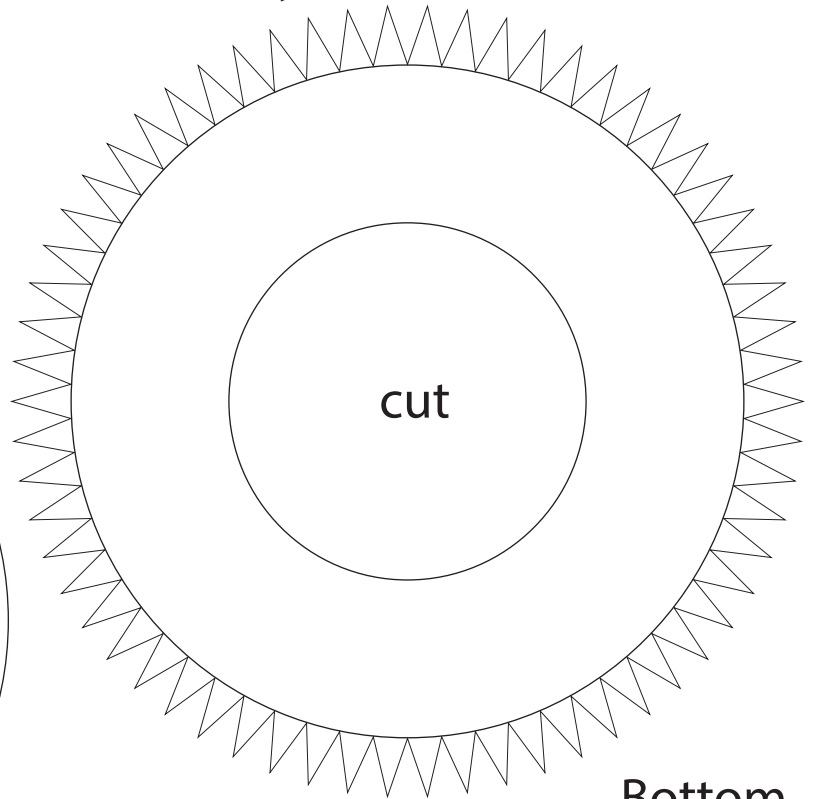

Bottom

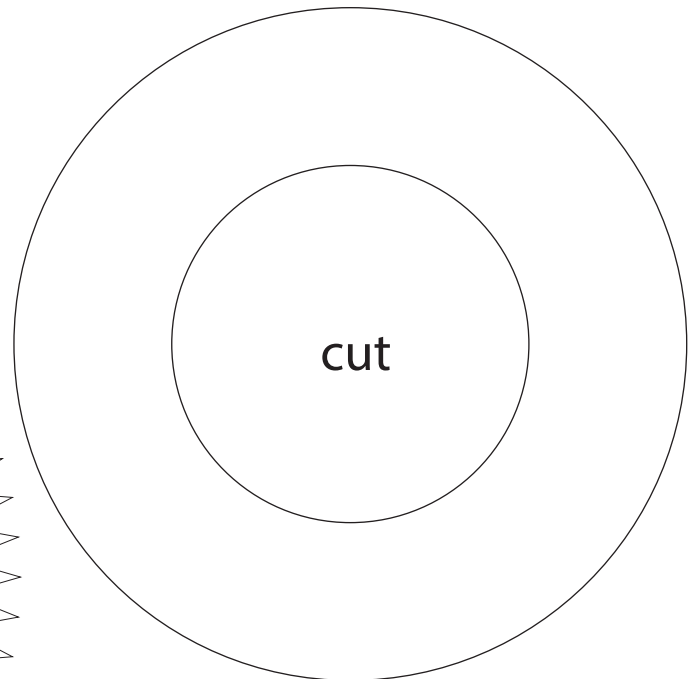
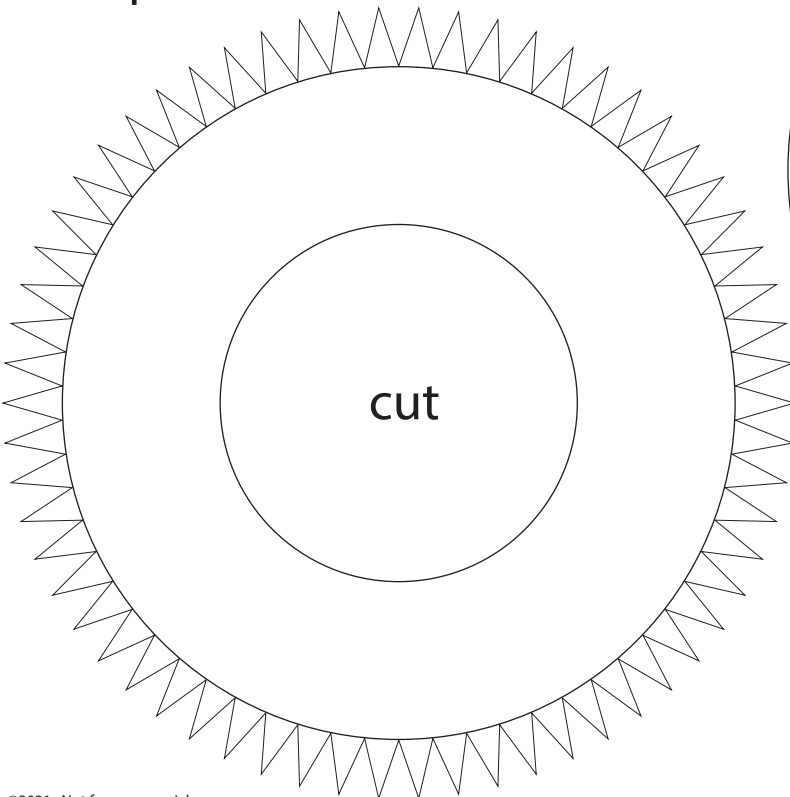

IMPORTANT

Top former is glued 20 mm from top edge of middle booster section. Bottom former is glued 20 mm from bottom edge of middle booster section.



1:100 Scale

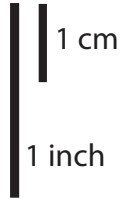

SpaceX Starship BN-4

Print on Cardstock (110 lbs)

Formers for bottom body

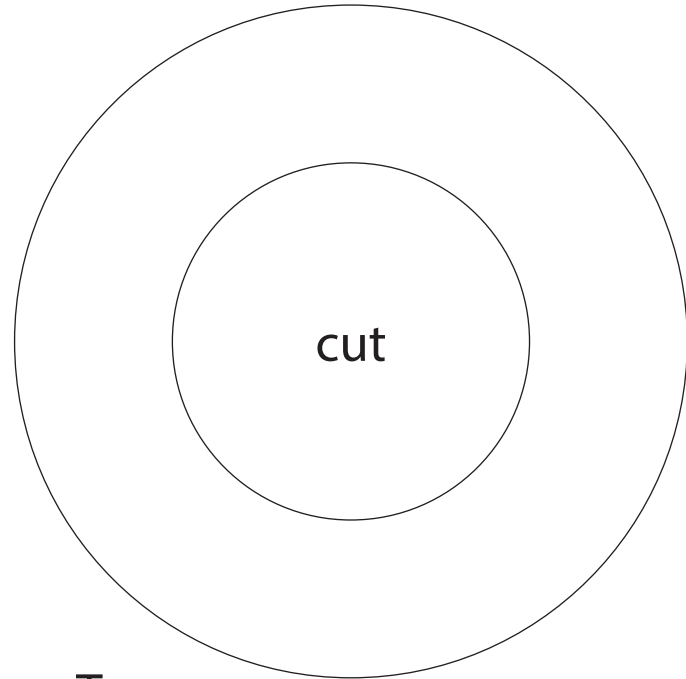

Top

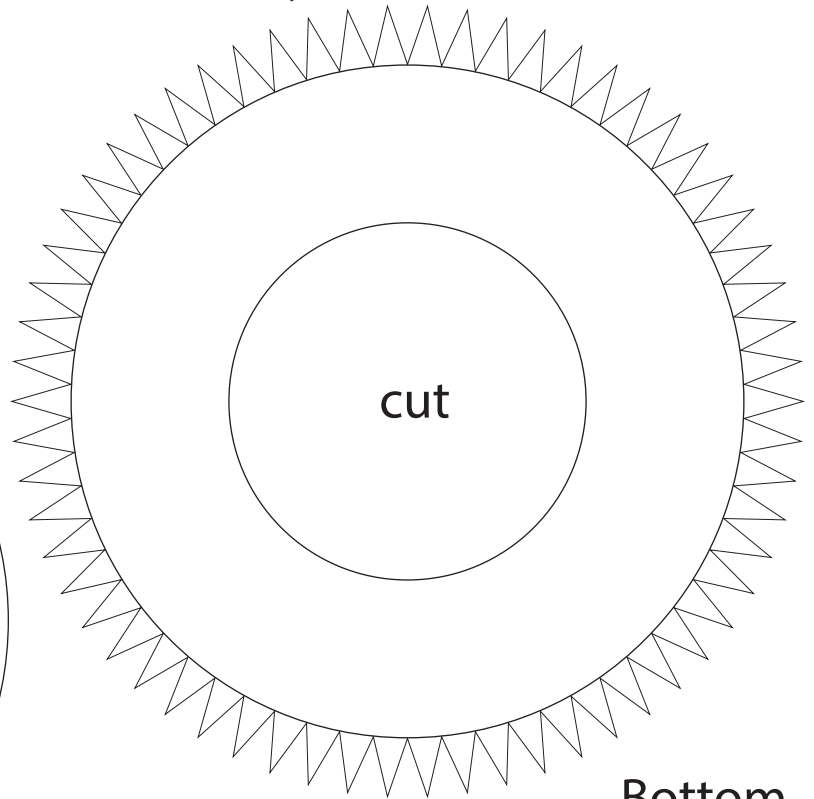

Bottom

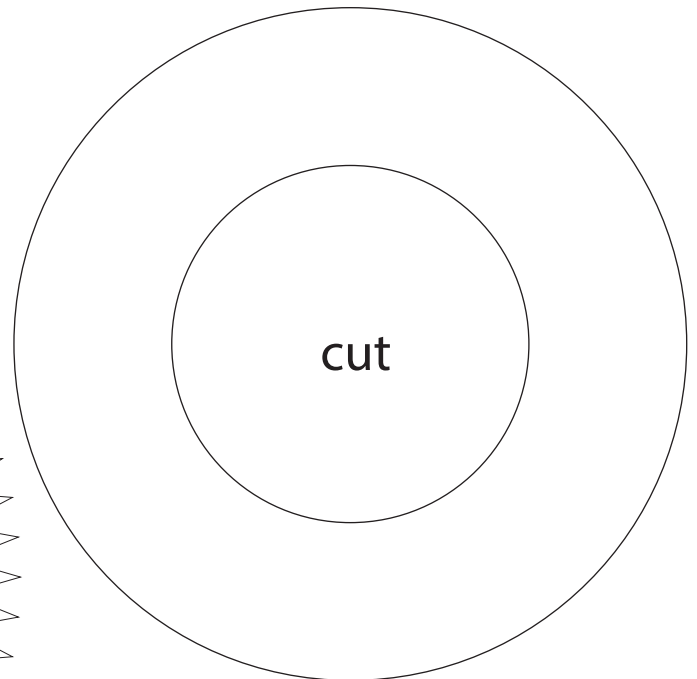
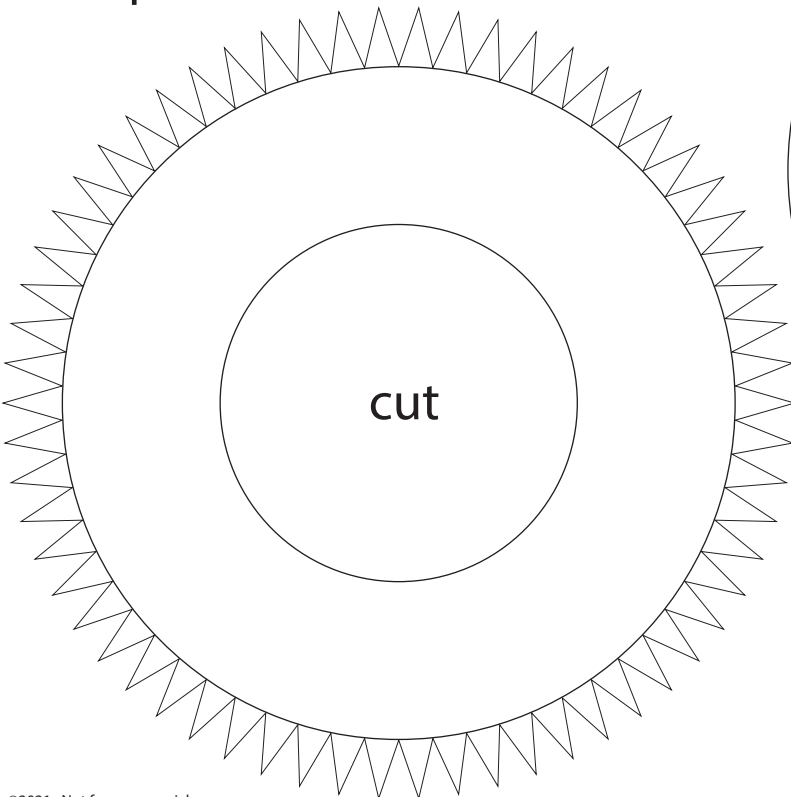

IMPORTANT

Top former is glued 20 mm from top edge of bottom booster section. Bottom former is glued 19 mm from bottom edge of bottom booster section.



1 cm

1 inch

1:100 Scale

SpaceX SuperHeavy

Print on Cardstock (110 lbs)

Revised

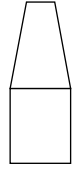

Outer Raptor ring

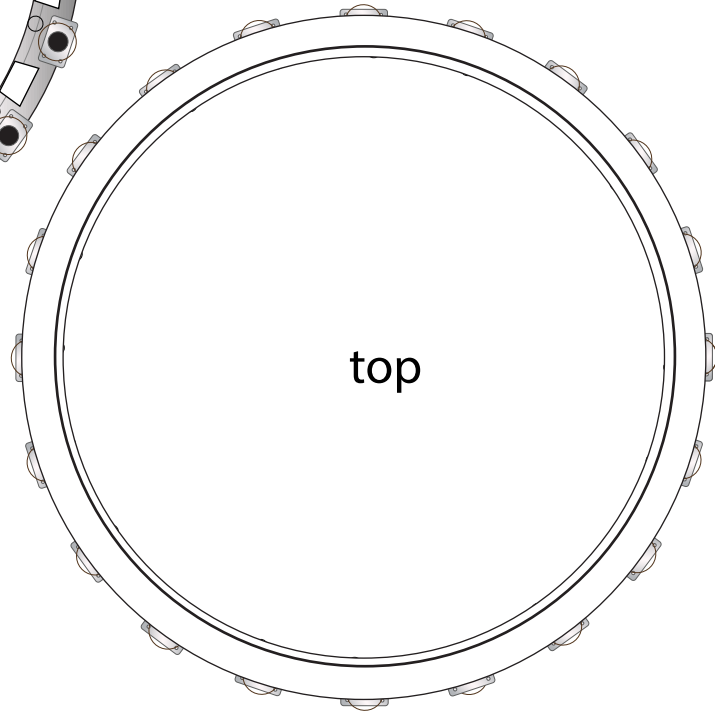
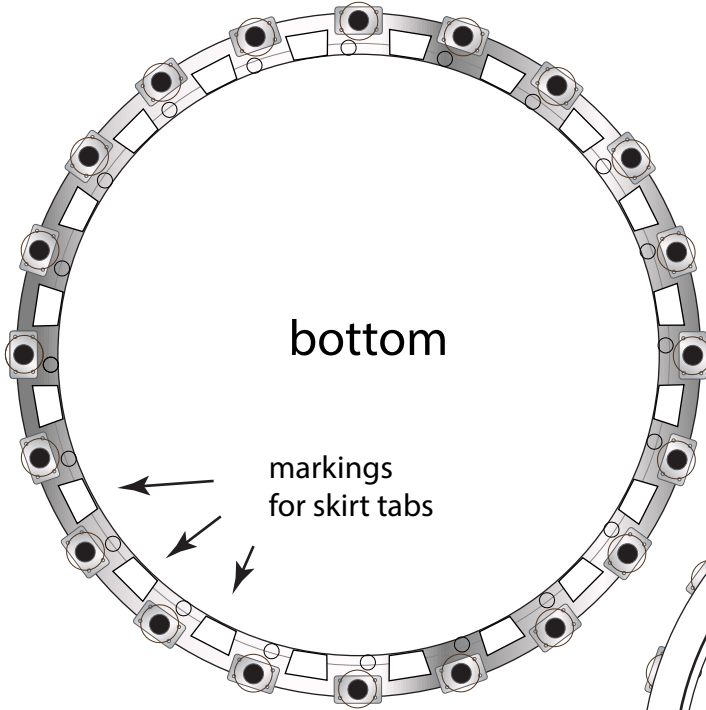

Engine section interior skin

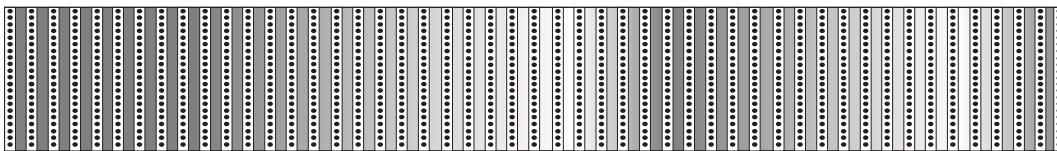
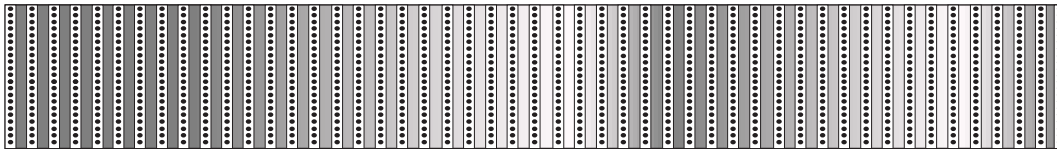



1 cm

1 inch

1:100 Scale

SpaceX Heavy Booster 7

Print on Cardstock (90 lbs)

Skirt for engine section

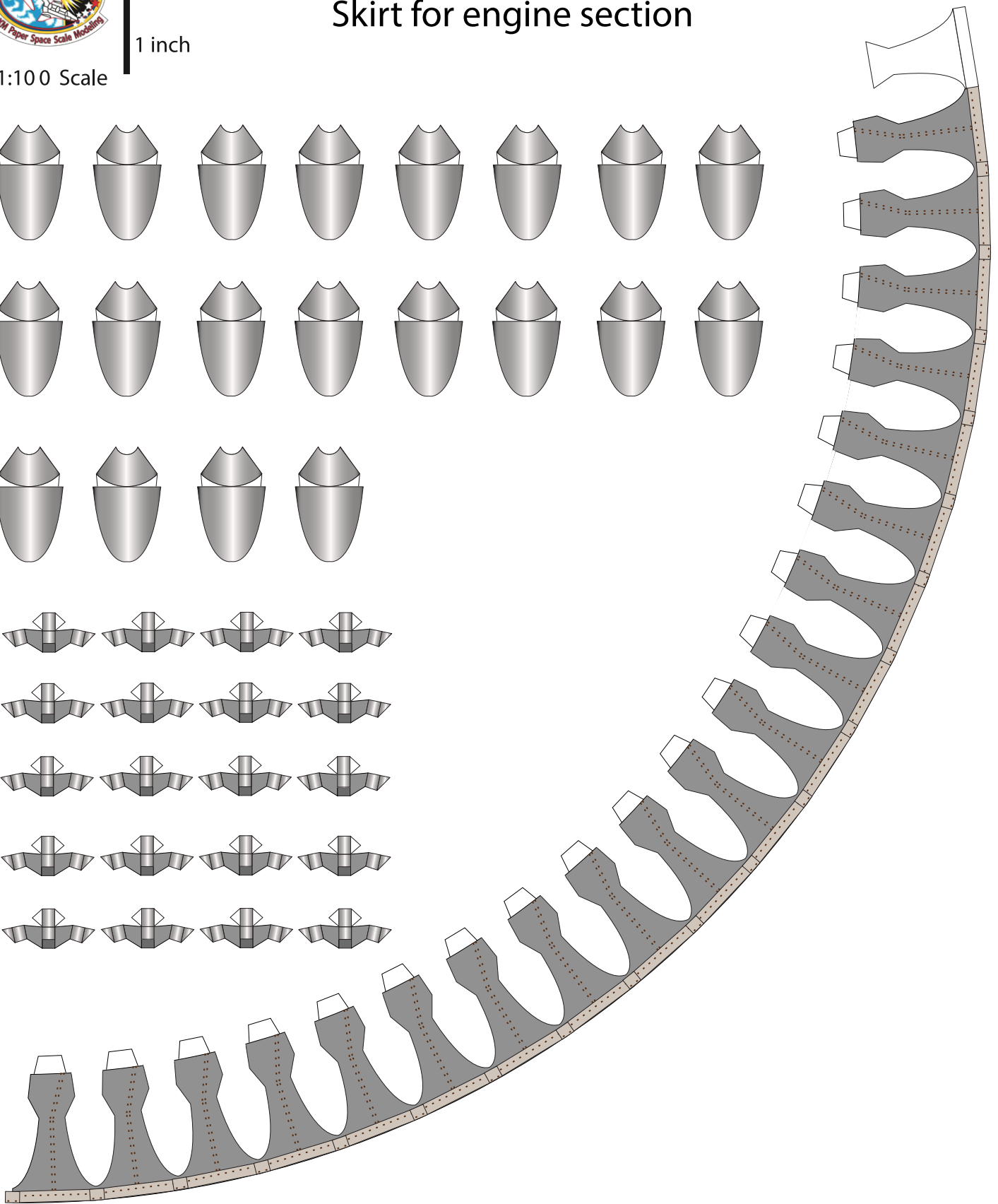
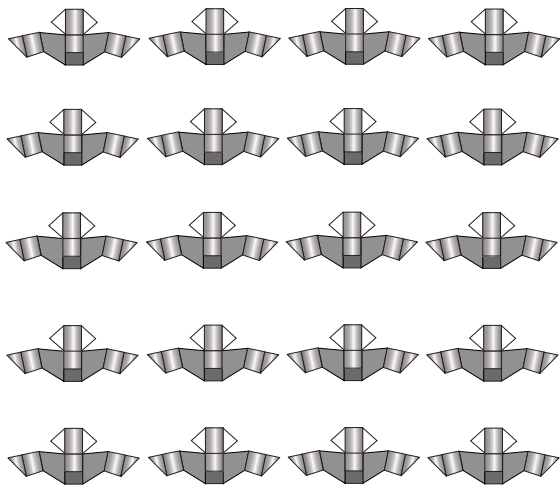
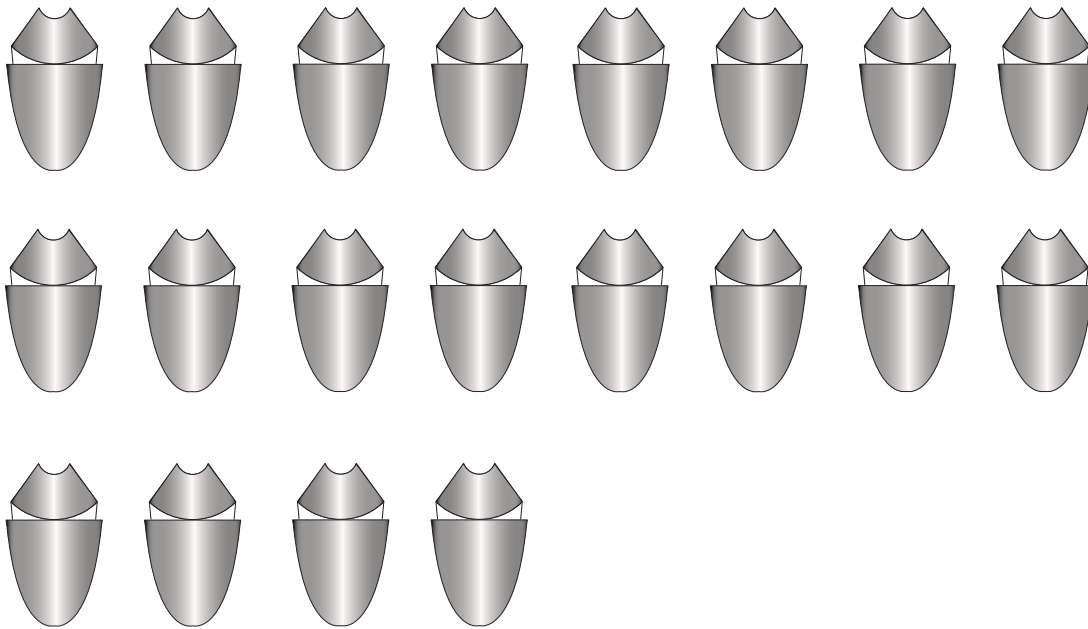



1 cm

1 inch

1:100 Scale

SpaceX Heavy Booster 7

Skirt floor and wall

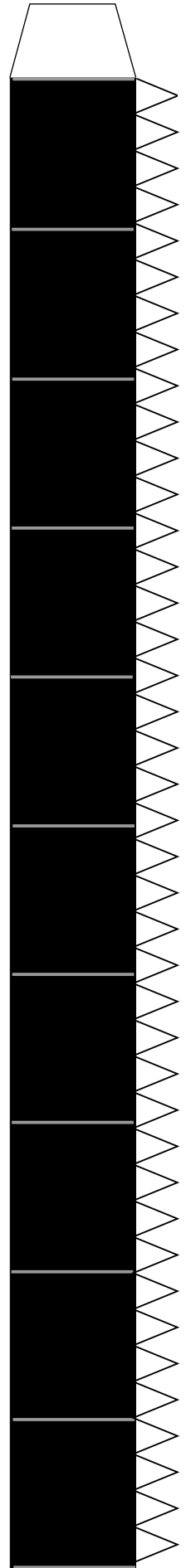
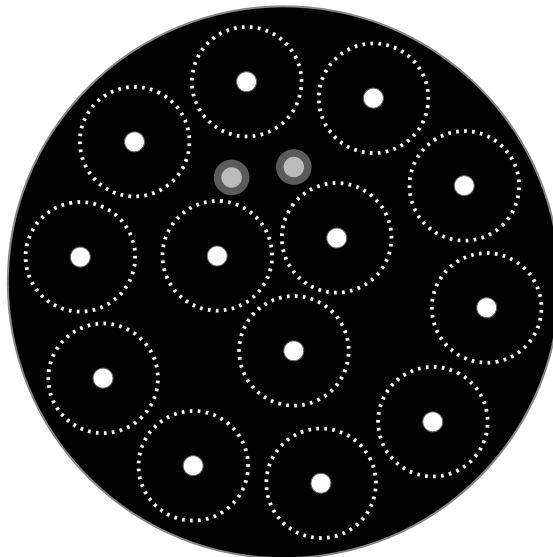
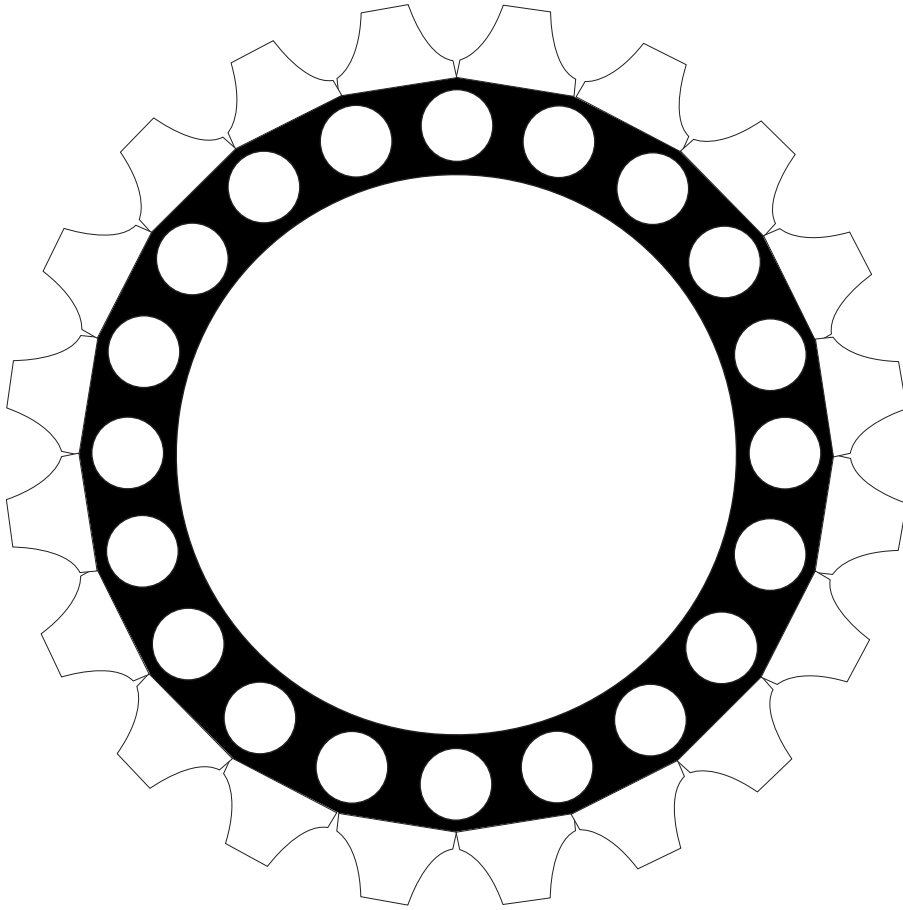

Print on Cardstock (90 lbs)



1:100 Scale

1 cm

1 inch

B7 inner Raptor covers

Print on cardstock

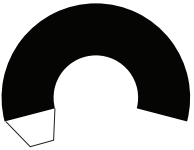
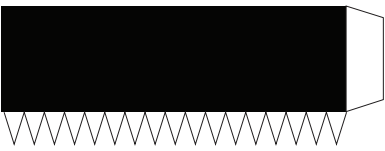
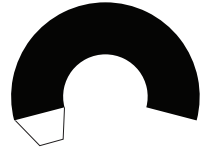
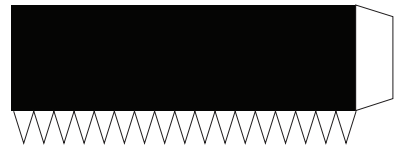
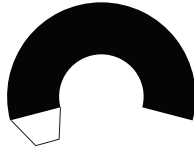
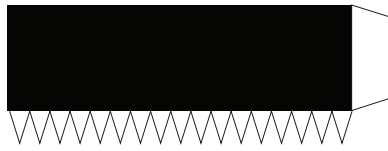
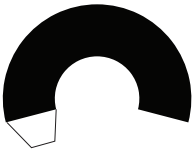
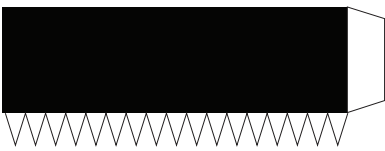
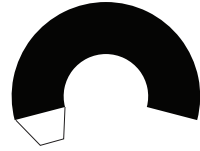
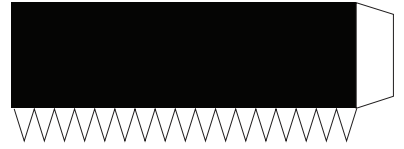
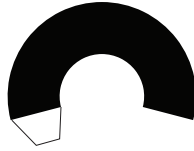
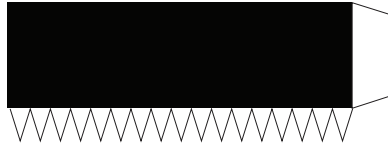
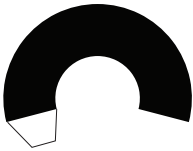
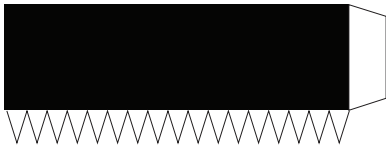
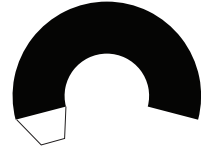
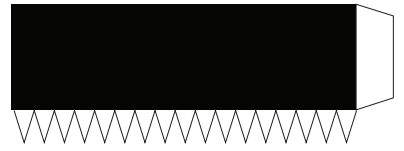
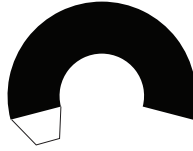
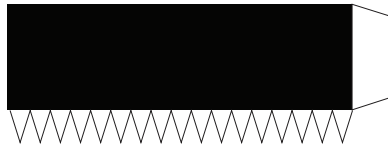
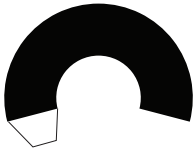
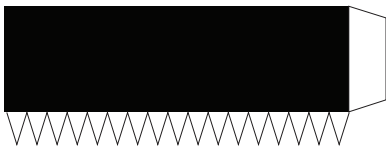
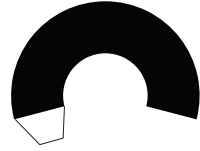
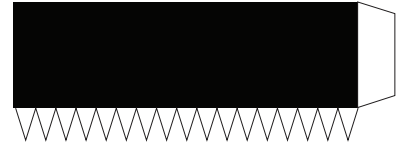
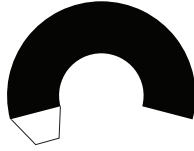
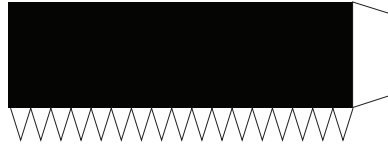
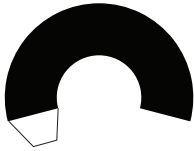
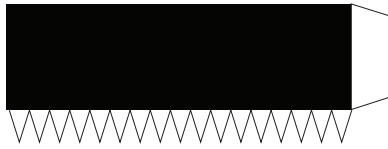



1 cm

1 inch

1:100 Scale

SuperHeavy Raptors

Print on Cardstock (110 lbs)

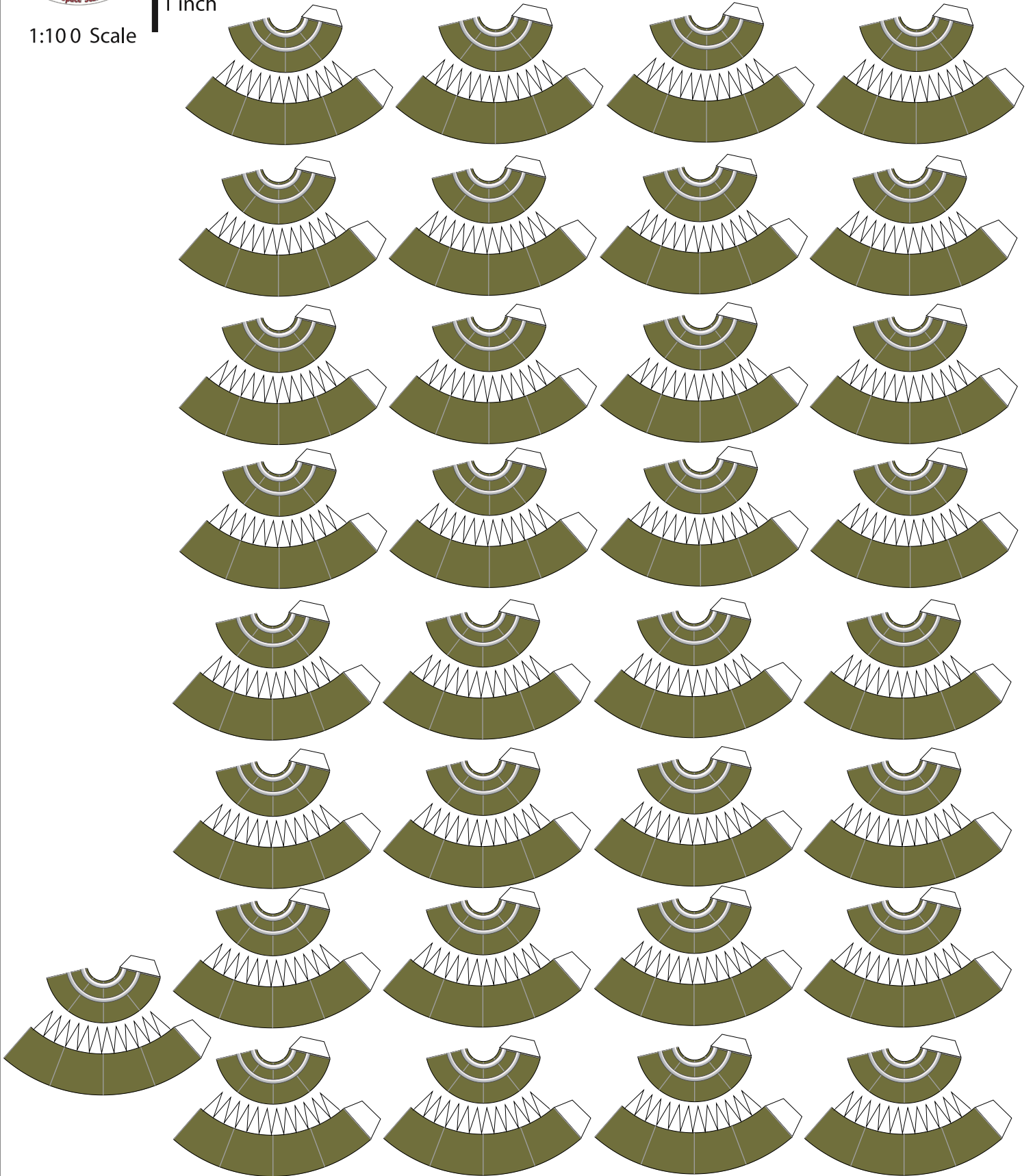



SuperHeavy Raptors BACKPRINT

Print on Cardstock (110 lbs)

