



1 cm  
1 inch

1:24

RLV

Print on Cardstock ( 110lb )

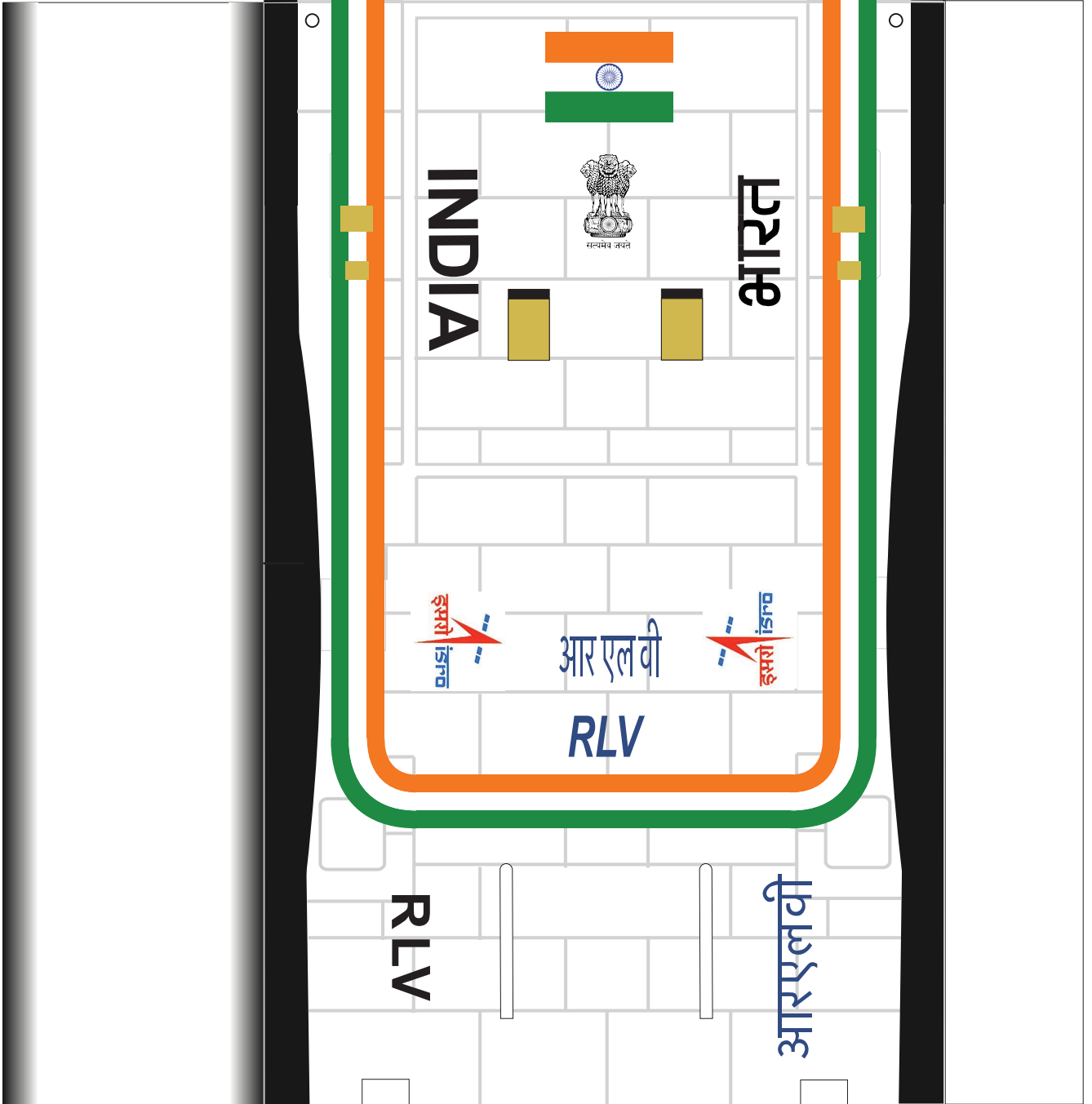



1 cm  
1 inch

1:24

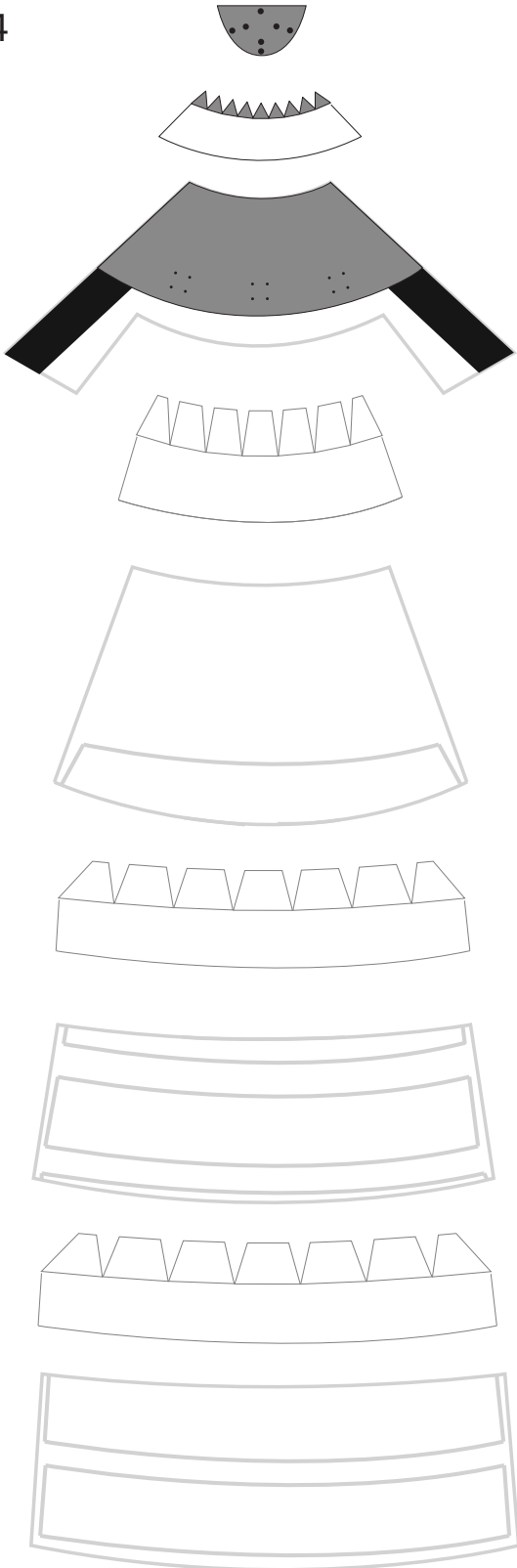

RLV

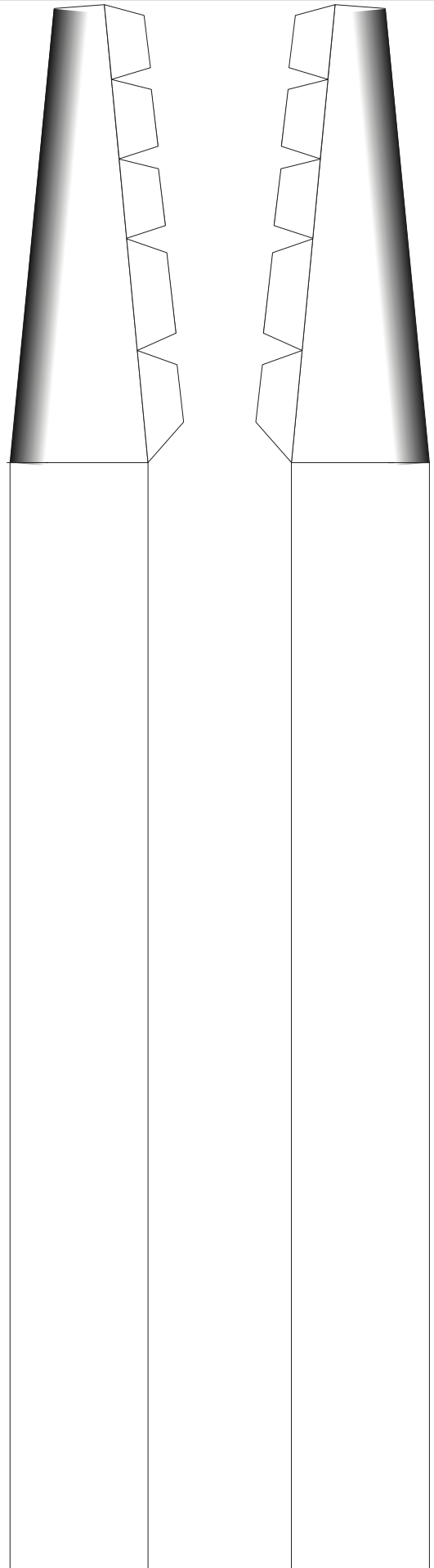

Print on Cardstock (110 lb)



RLV

Print on Cardstock ( 110 lb )

1:24

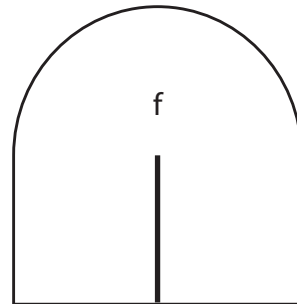
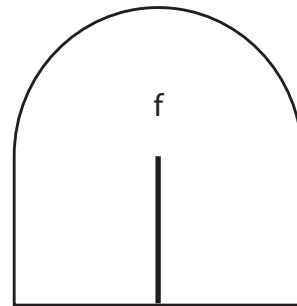
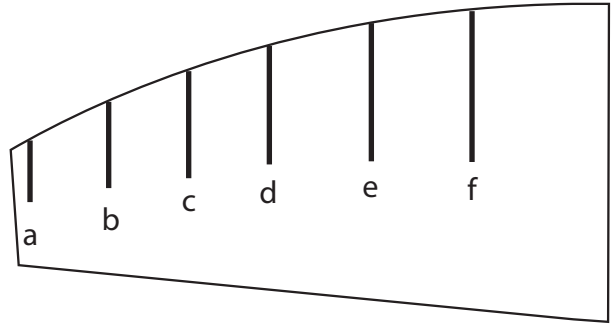
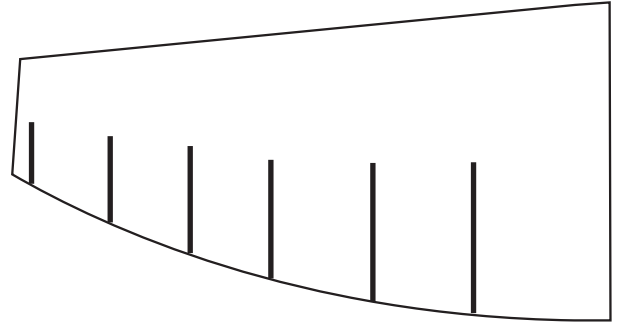
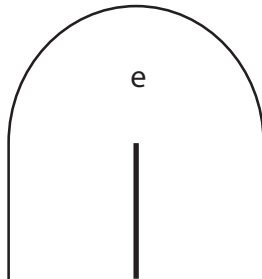
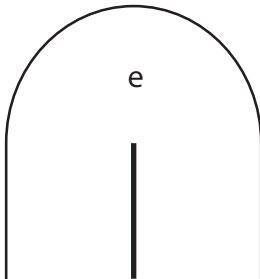
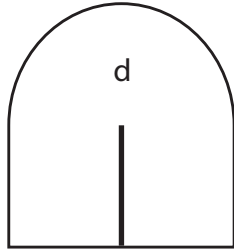
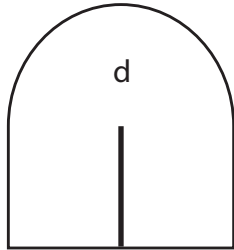
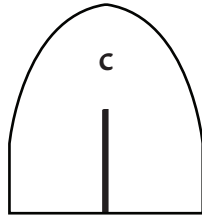
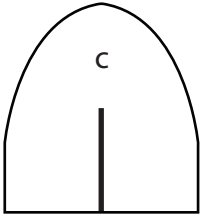
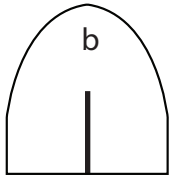
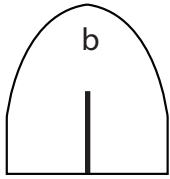
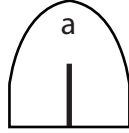
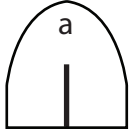



1 cm  
1 inch

RLV

Print on Cardstock ( 110 lb )

1:24

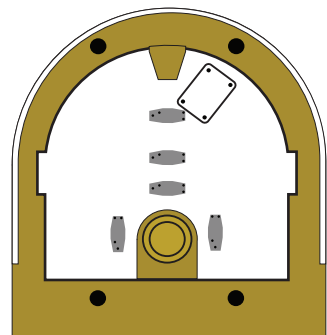
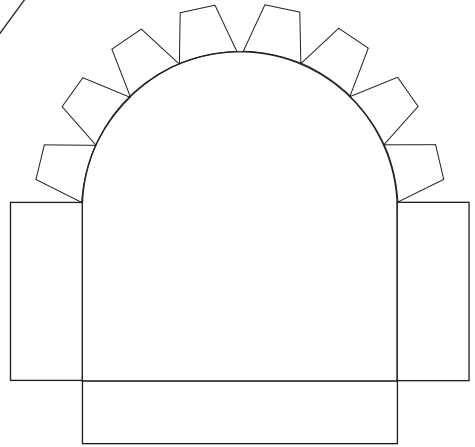
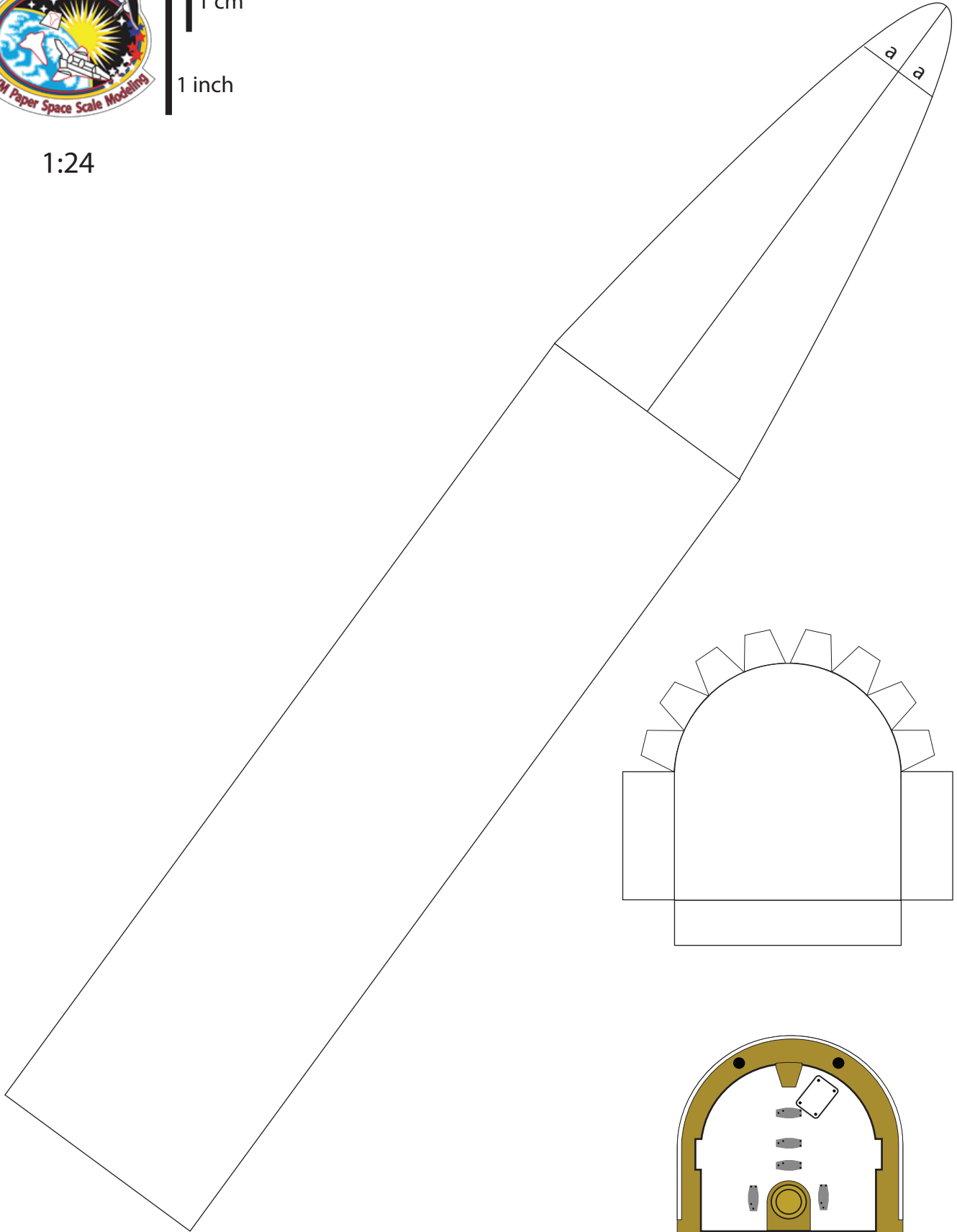



1 cm  
1 inch

RLV

Print on Cardstock ( 110 lb )

1:24

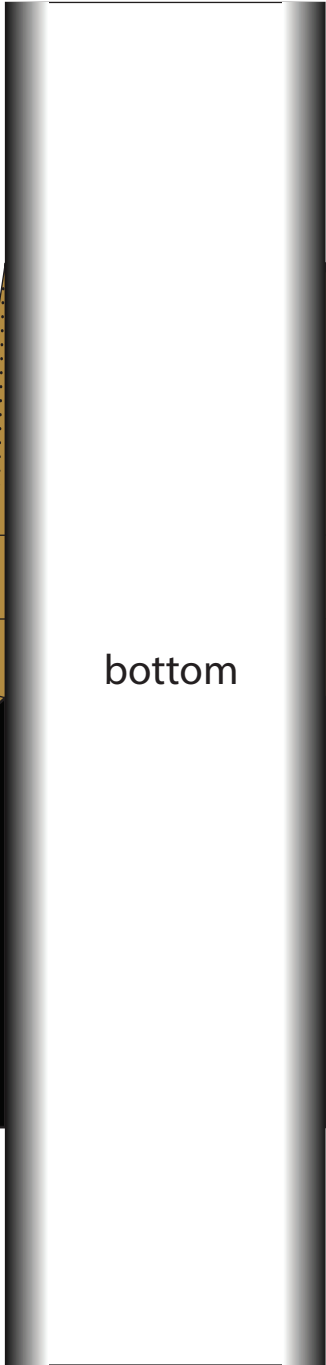
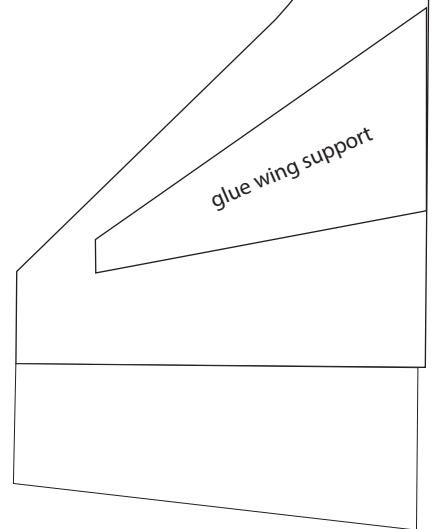
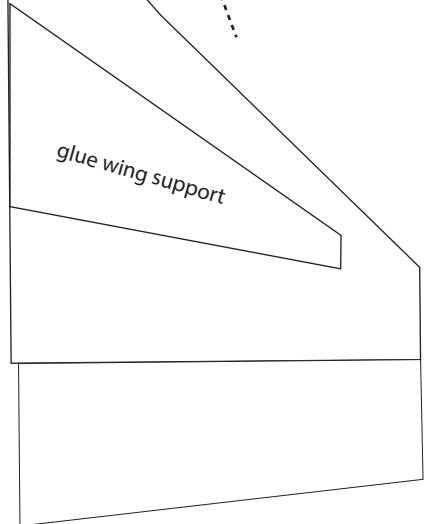
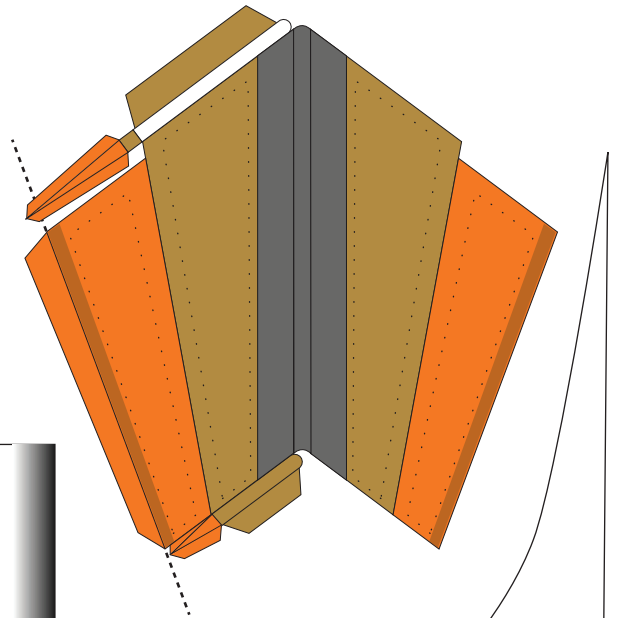
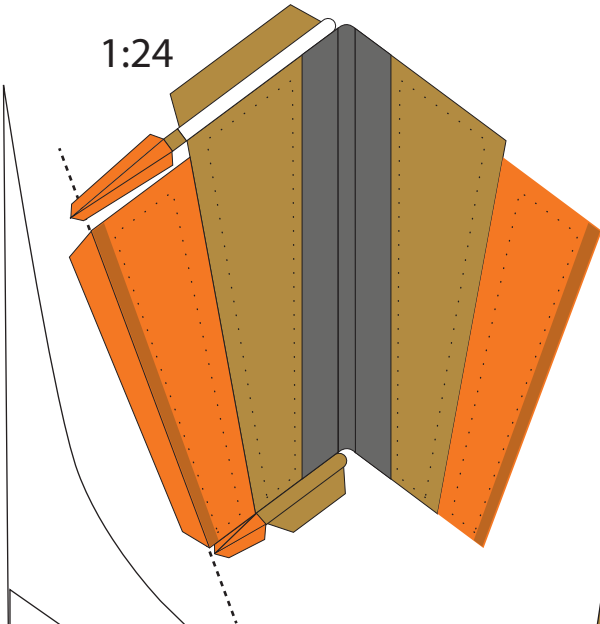

bottom

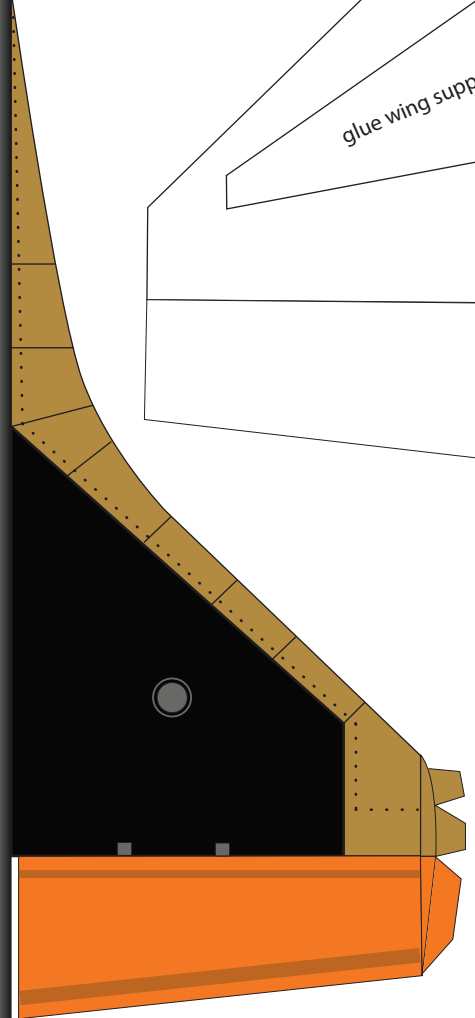
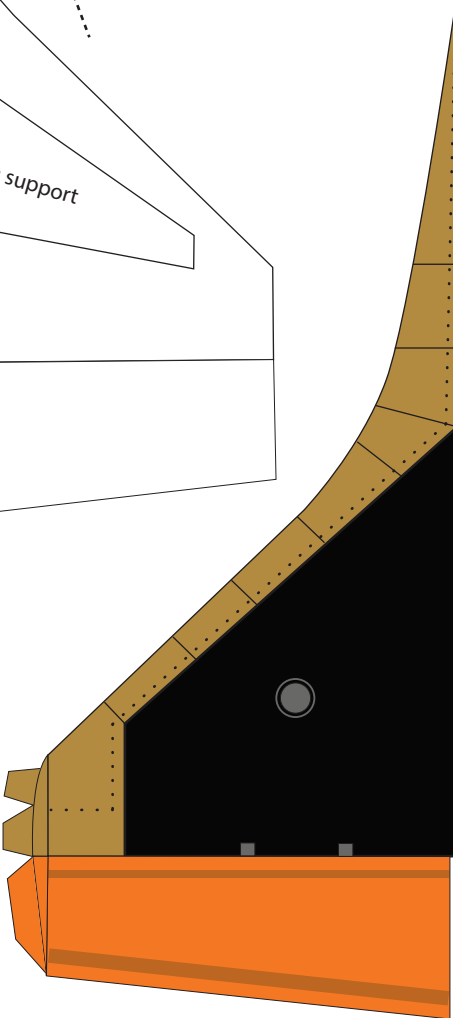



1 cm  
1 inch

RLV

Print on Cardstock ( 110 lb )

1:24

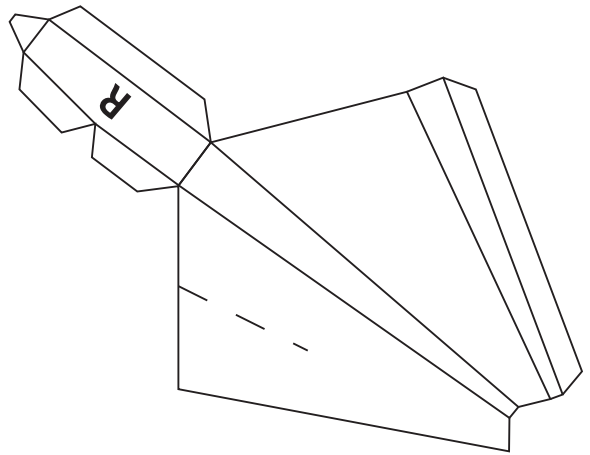
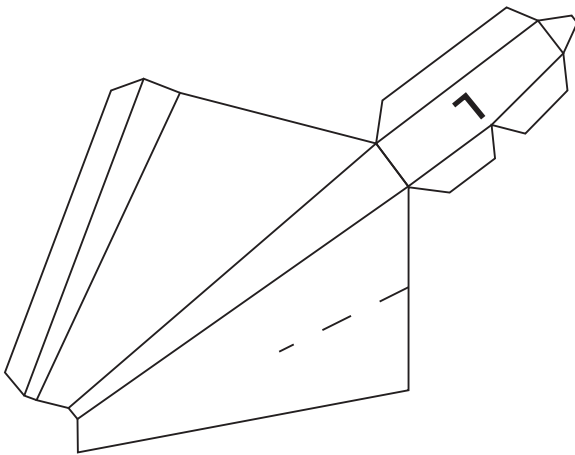
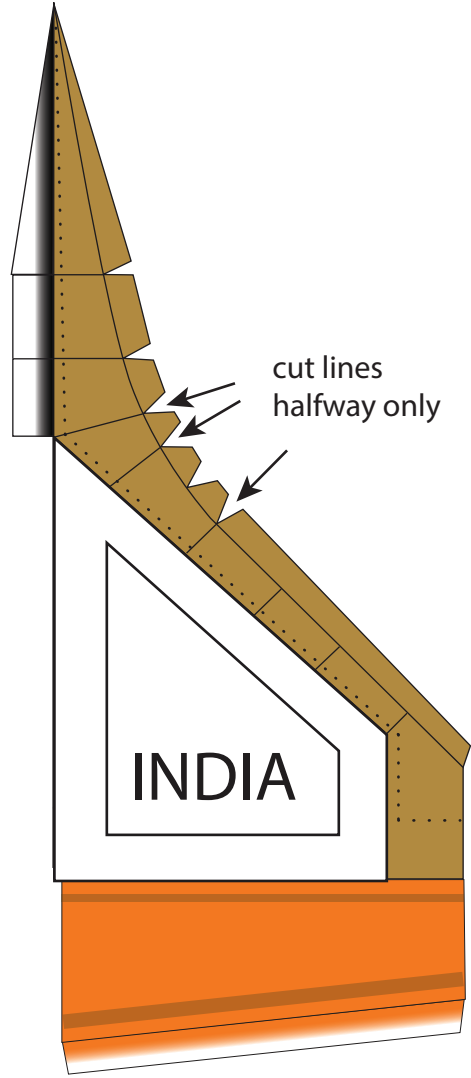
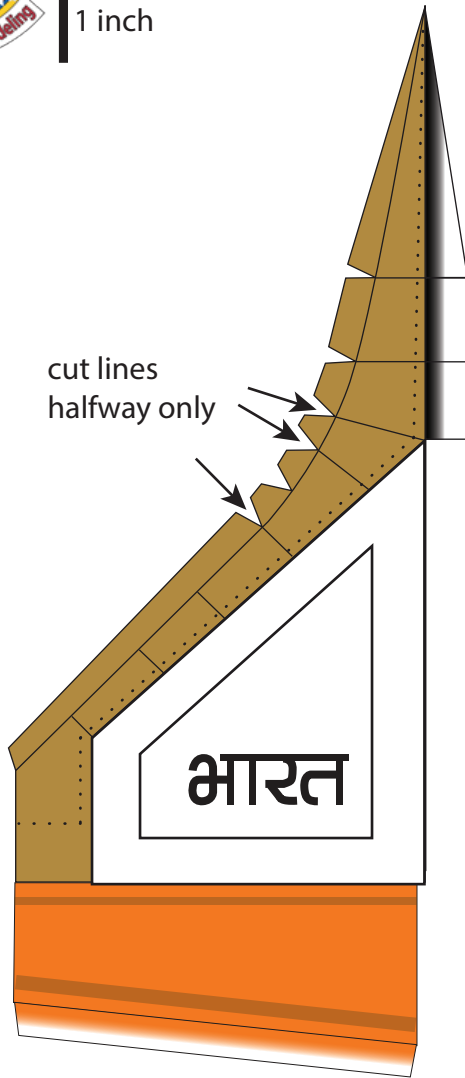

Wing supports designed by Richard De Vries



1 cm  
1 inch

# RLV

Print on Cardstock ( 110 lb )

1:24

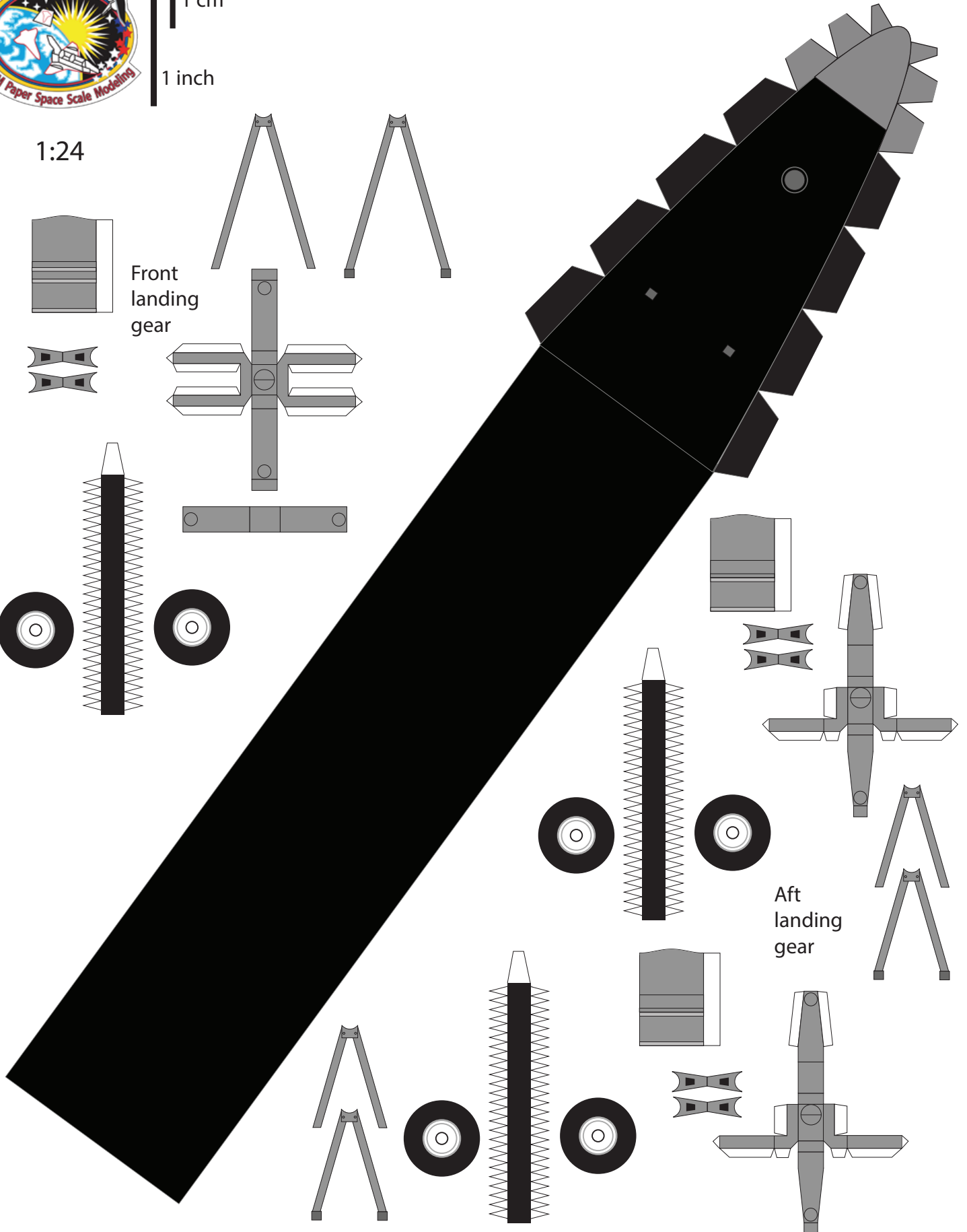

Front landing gear

Aft landing gear