



1 cm
1 inch

Nauka

Print on Cardstock (110 lbs)

1:100 Scale

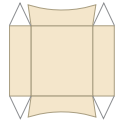
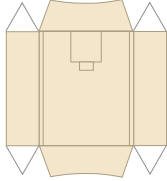
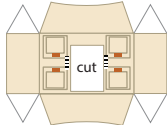
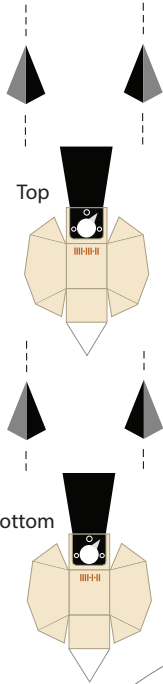
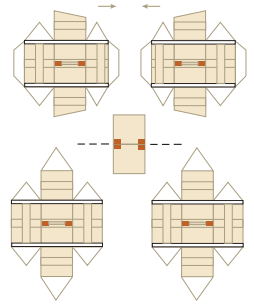
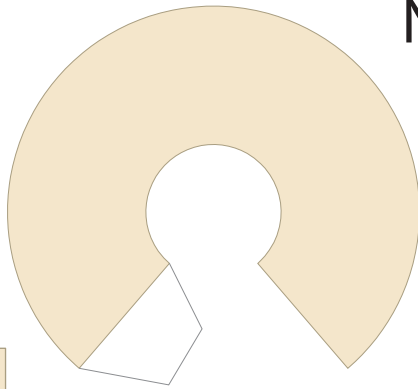

c

b

a

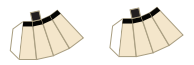
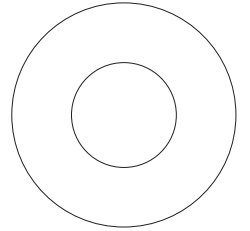
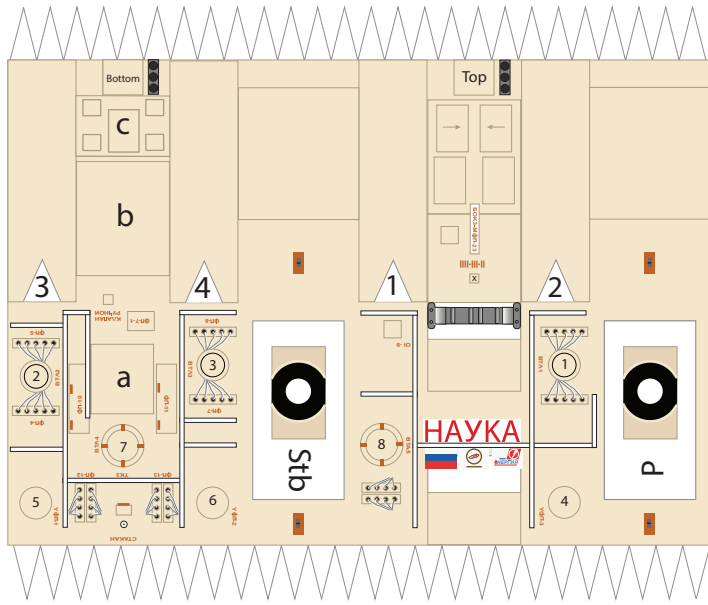
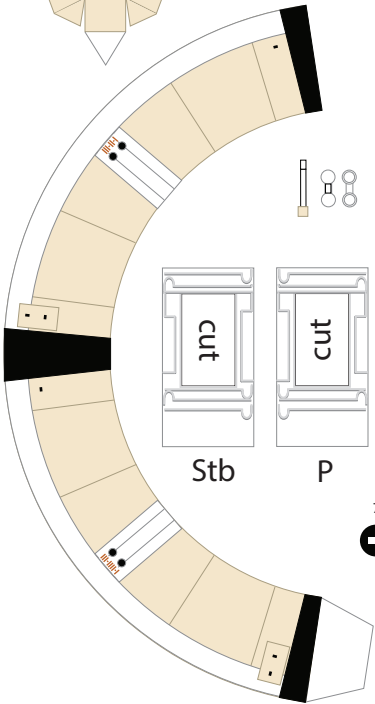
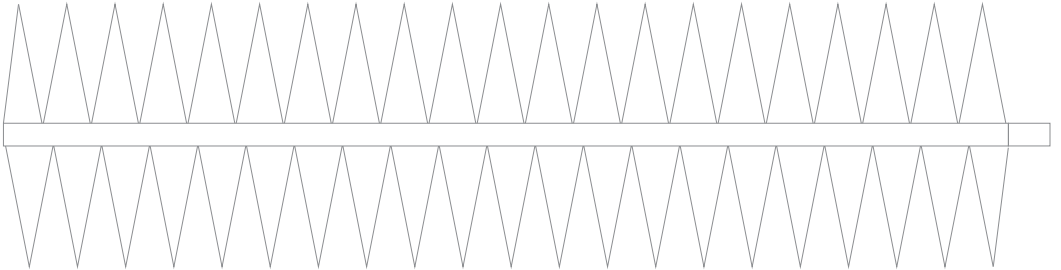

Star trackers

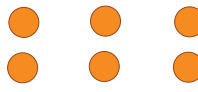
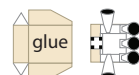
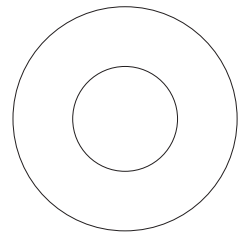

1

2

3

4

5

6

8

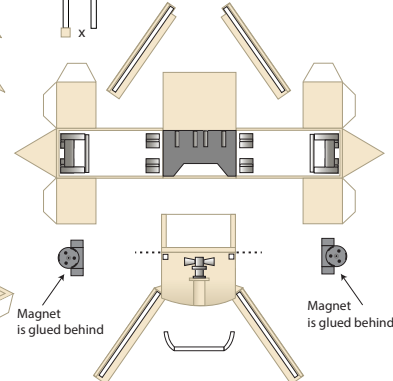
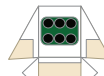
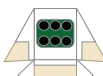



1 cm
1 inch

Nauka

Print on Cardstock (110 lbs)

1:100 Scale

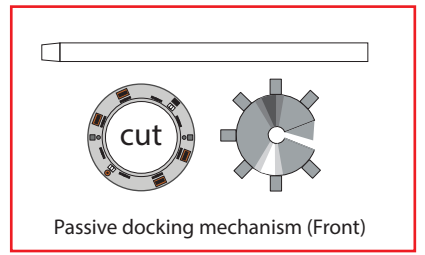
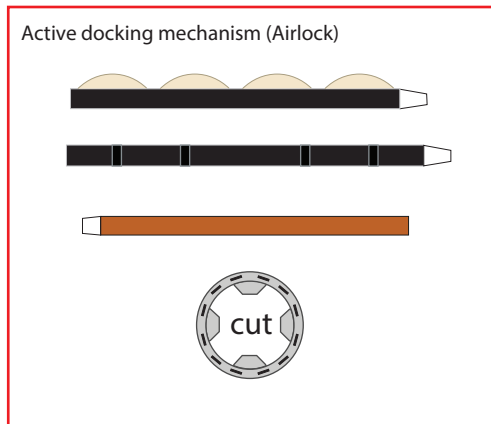
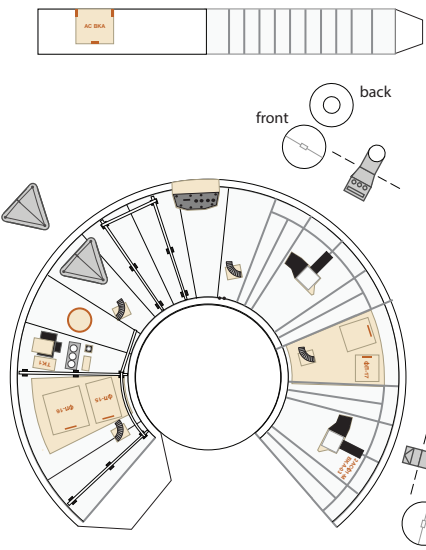
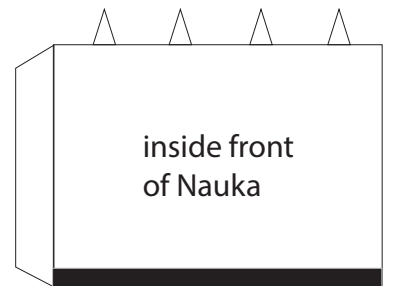
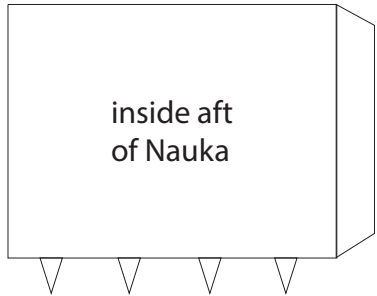
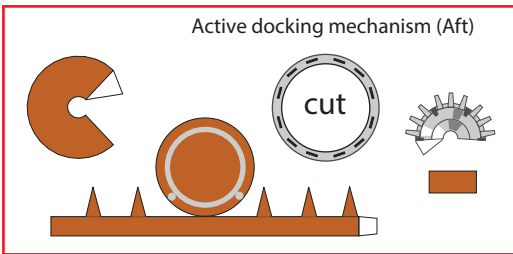
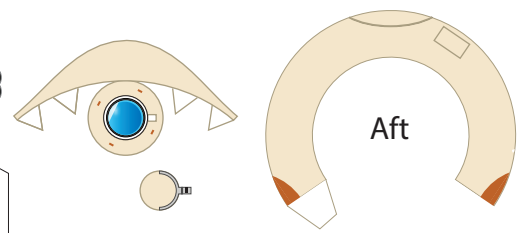
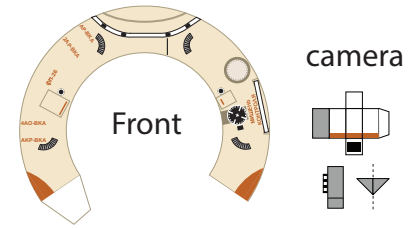
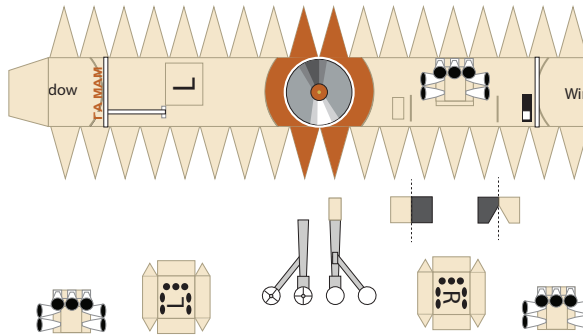
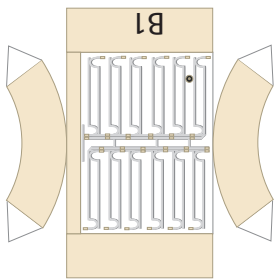
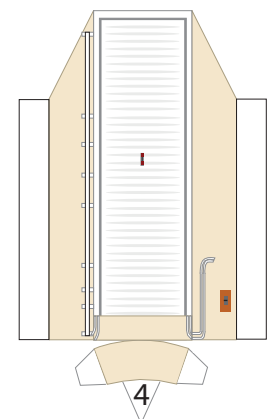
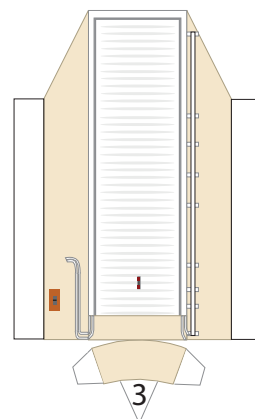
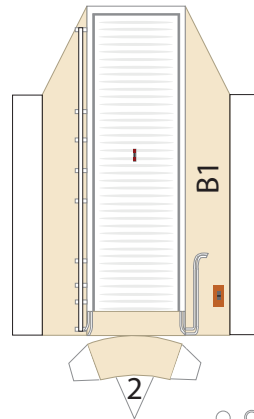
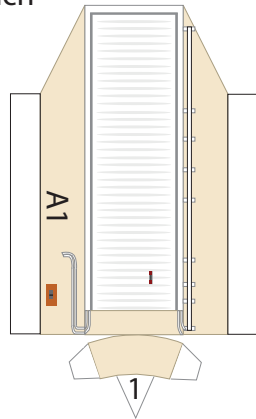
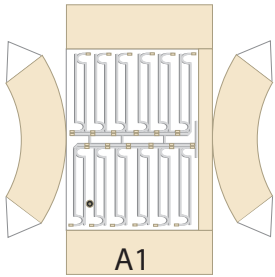



Nauka solar panels

Print on Cardstock (90 lbs)

1:100 Scale

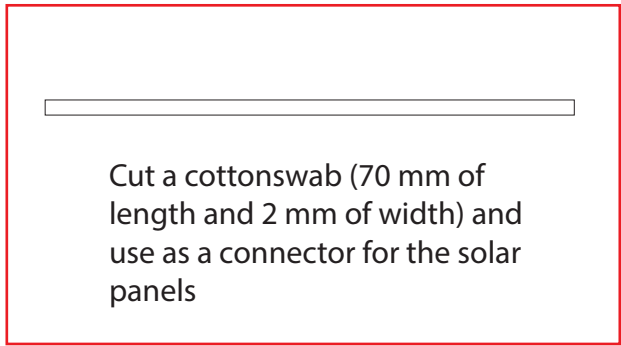
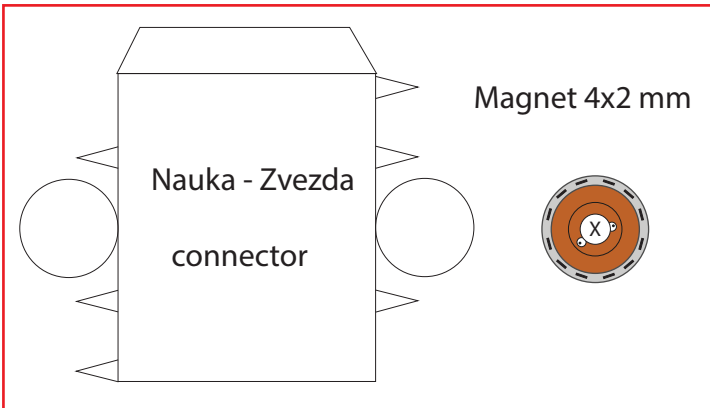
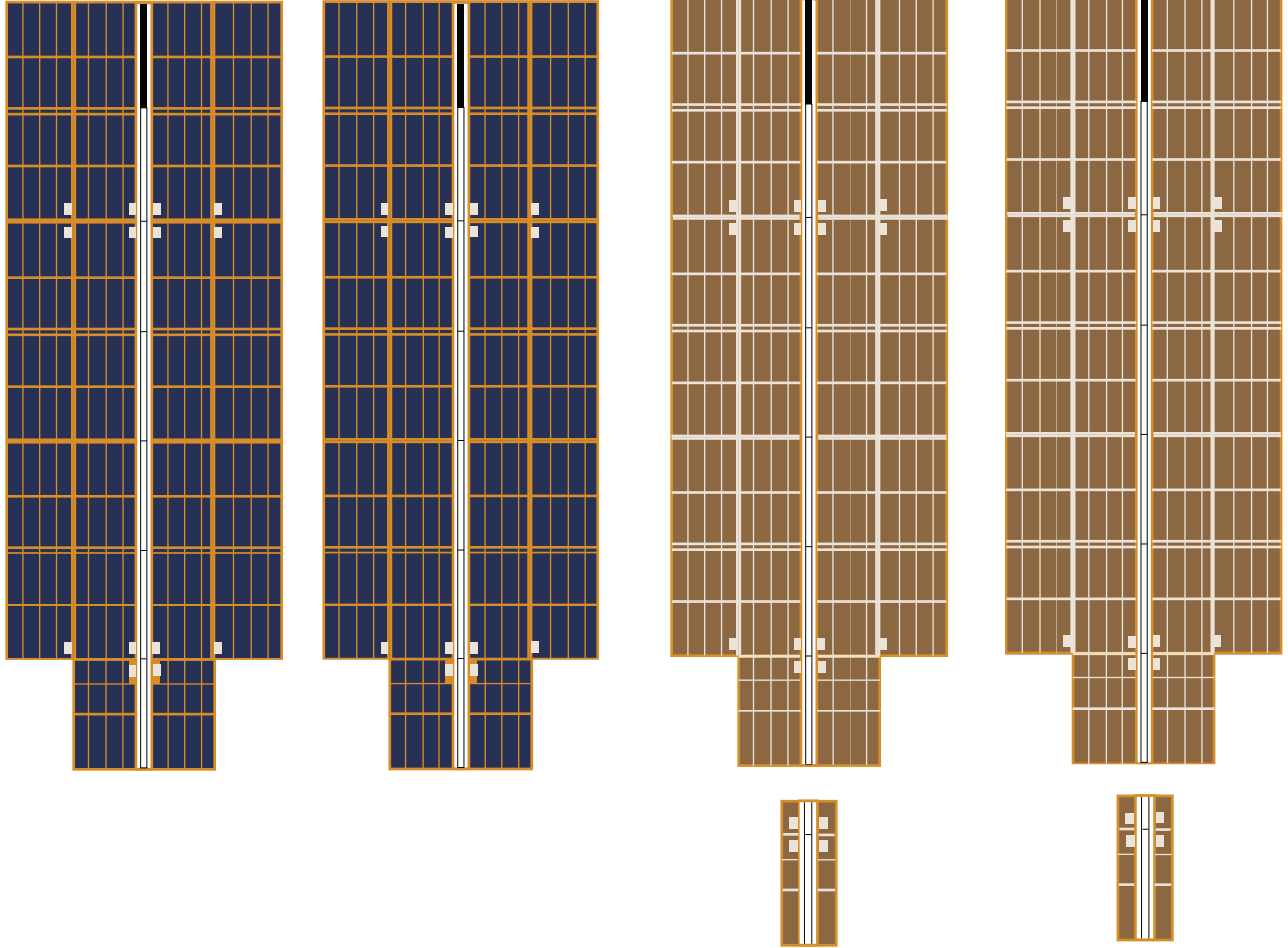



1 cm
1 inch

Nauka

Print on Cardstock (90 lbs)

1:100 Scale

ERA
DIAGRAM

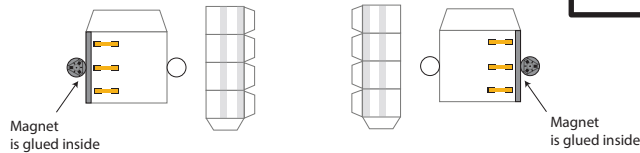
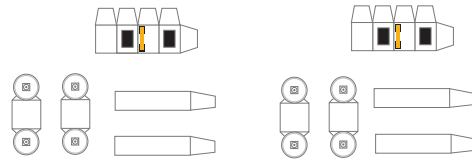
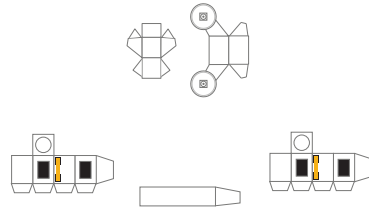
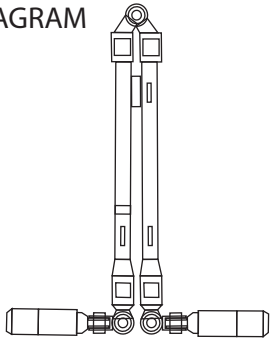

Print on Paper

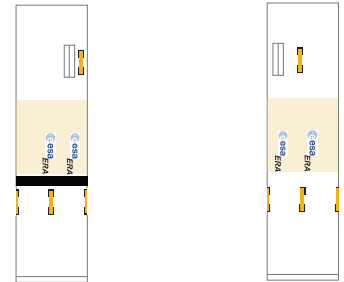

These parts will cover a cotton swab segment of the same length.
Cotton swab width approx 2 mm for this scale.

SKKO Platform

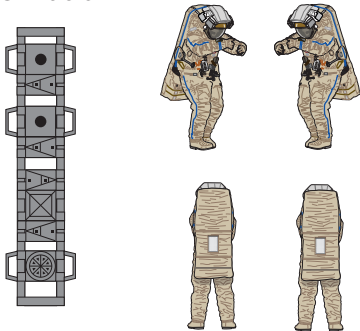

Science
Platform Mounts

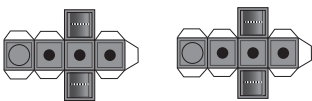

ERA cover

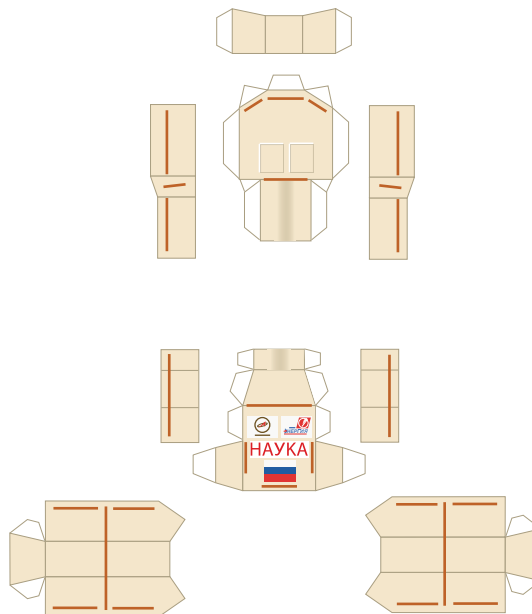

Cosmonauts designed by
Vad Kuz



1 cm
1 inch

Print on Cardstock (90 lbs)

Nauka

Nauka Airlock

1:100 Scale

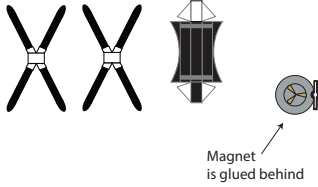
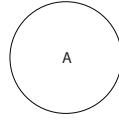

Airlock transfer boom

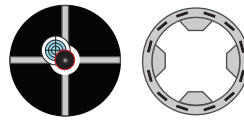
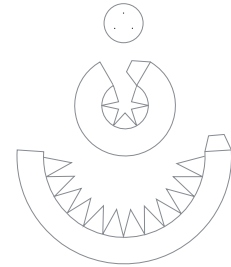
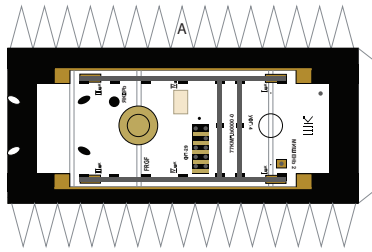
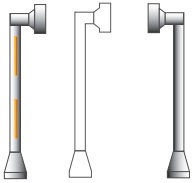

align with airlock seamline

Nauka Radiator

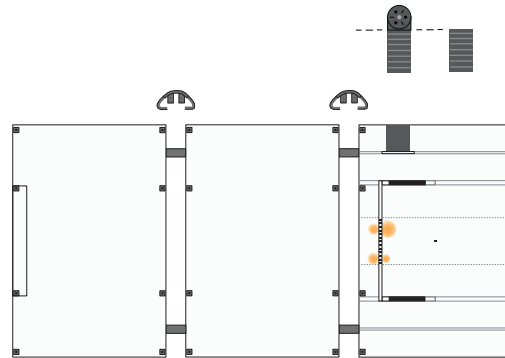
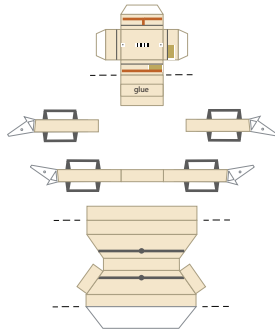

Portable Work Platform

