

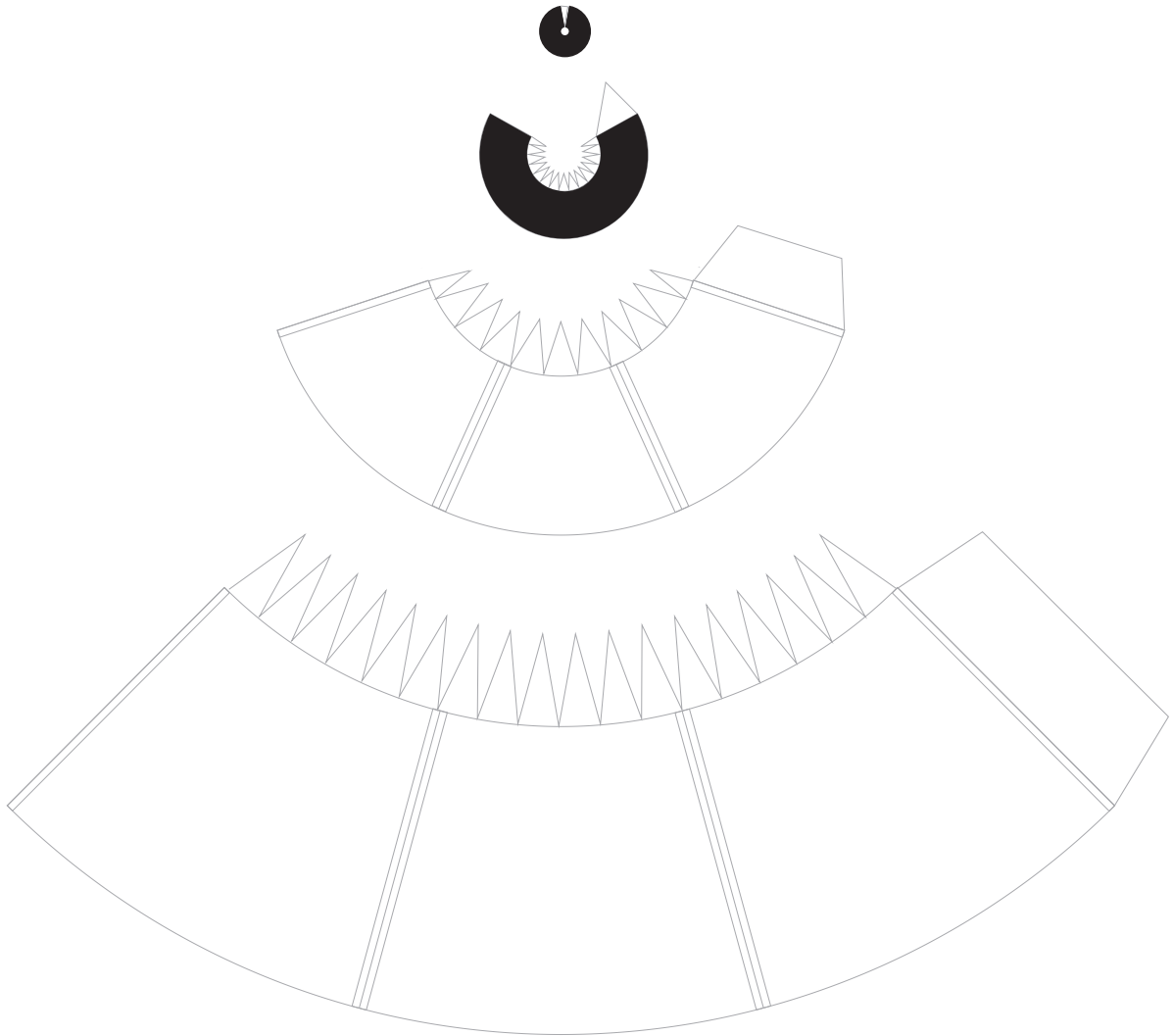

Print on Cardstock (110 lbs)

# Delta IV Nosecone Long Trisector Fairing

1:96 Scale





Delta IV Heavy

Print on Cardstock (110 lbs)

NROL-68 Payload  
Long Trisector Fairing

1:96 Scale

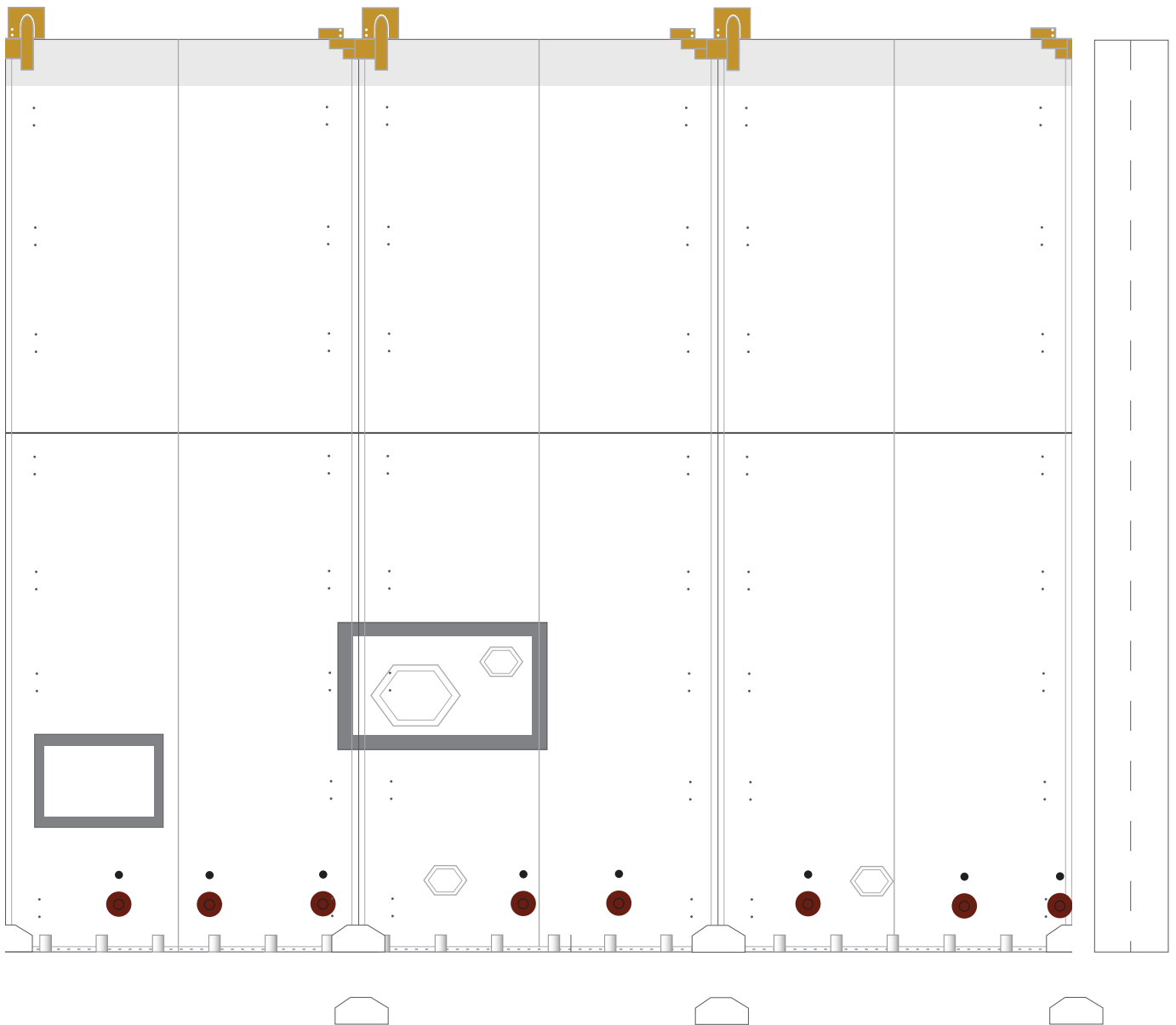



1 cm  
1 inch

# NROL-68 Insterstage

Print on Cardstock (110 lbs)

1:96 Scale

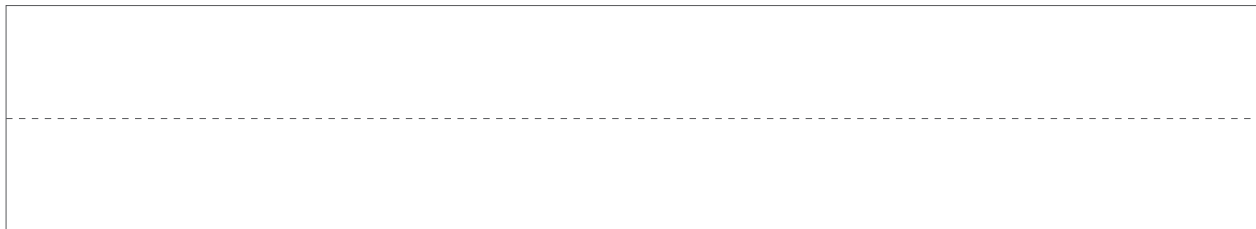
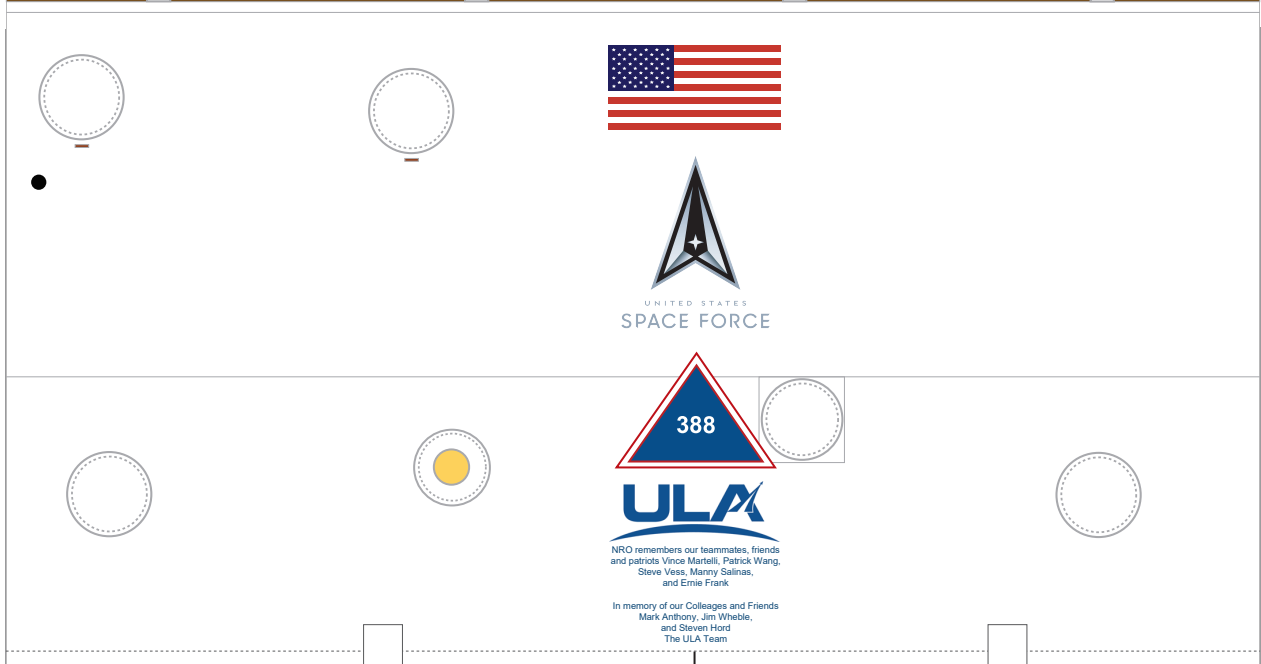
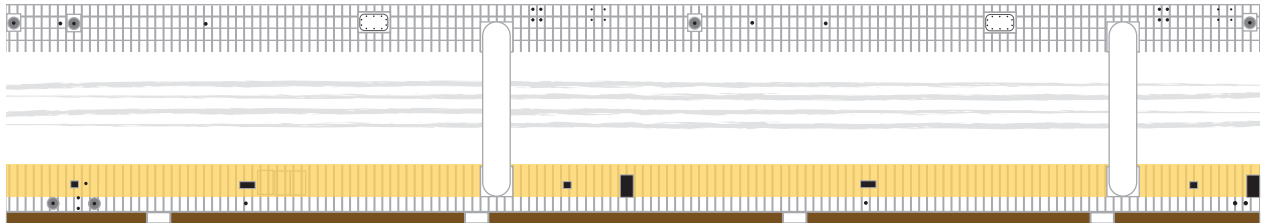
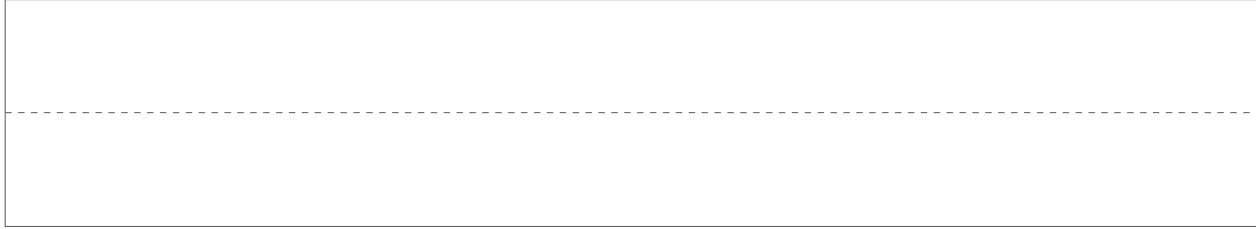



NROL-68

Print on Cardstock (110 lbs)

# Delta IV Common Booster Core Center

1:96 Scale

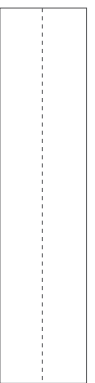
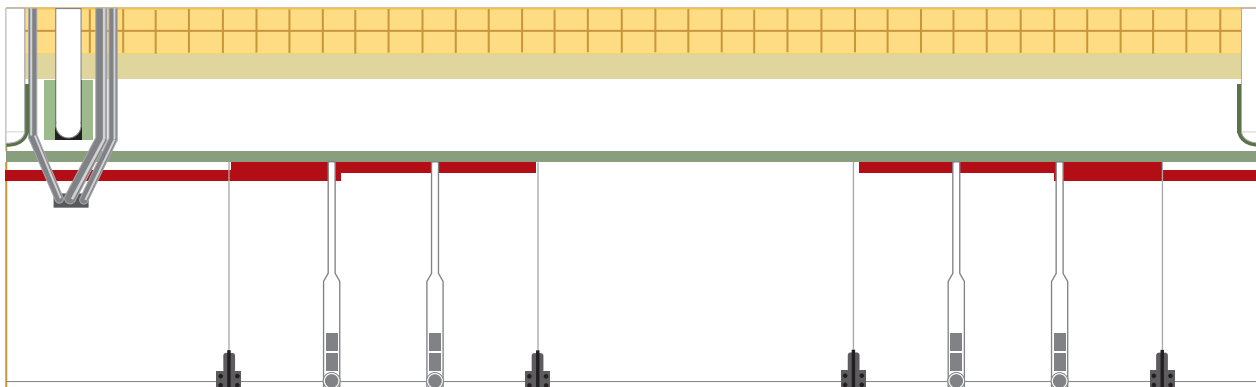
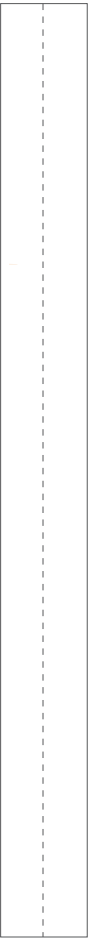
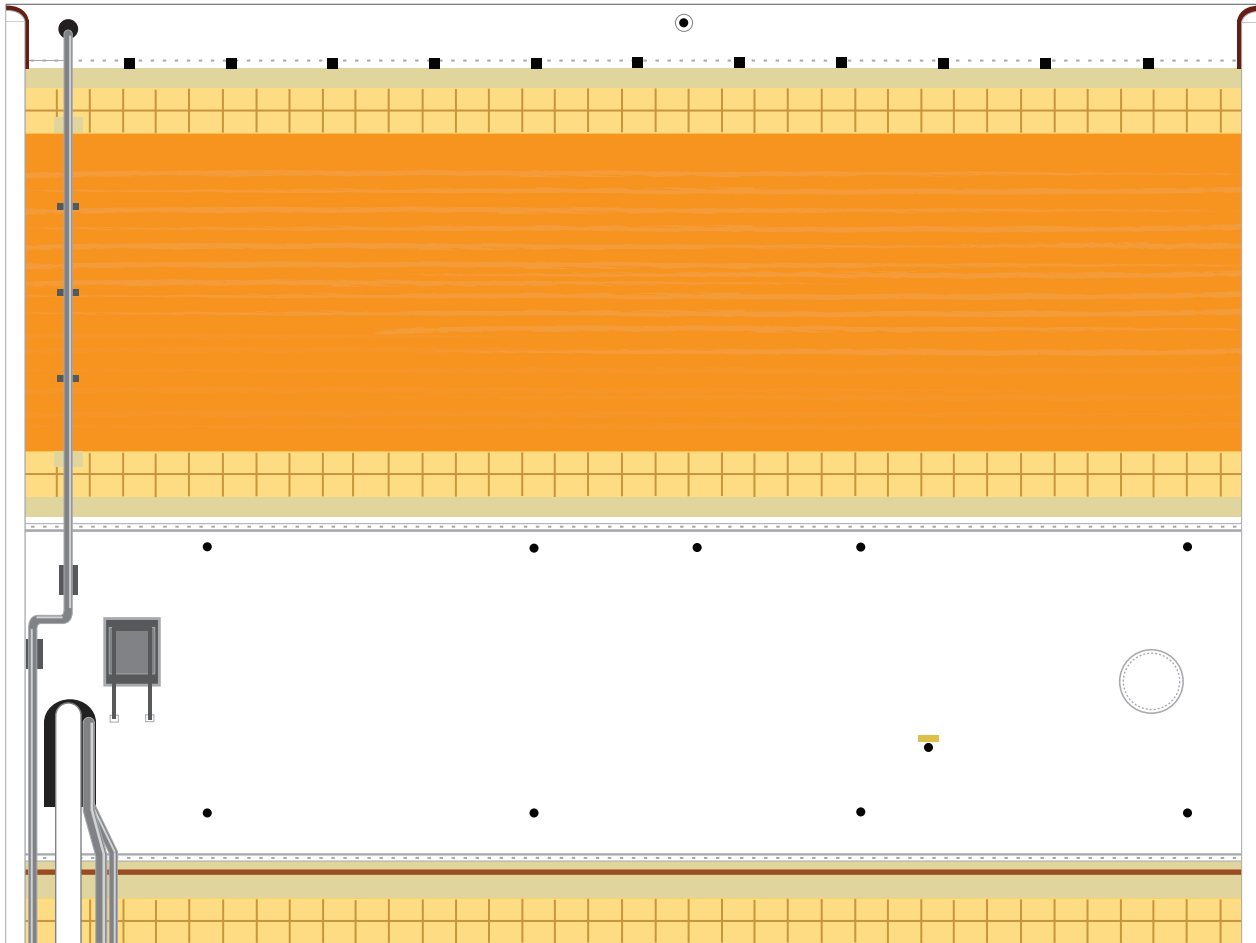





# Center Delta IV Common Booster Core

Print on Cardstock (110 lbs)

1:96 Scale

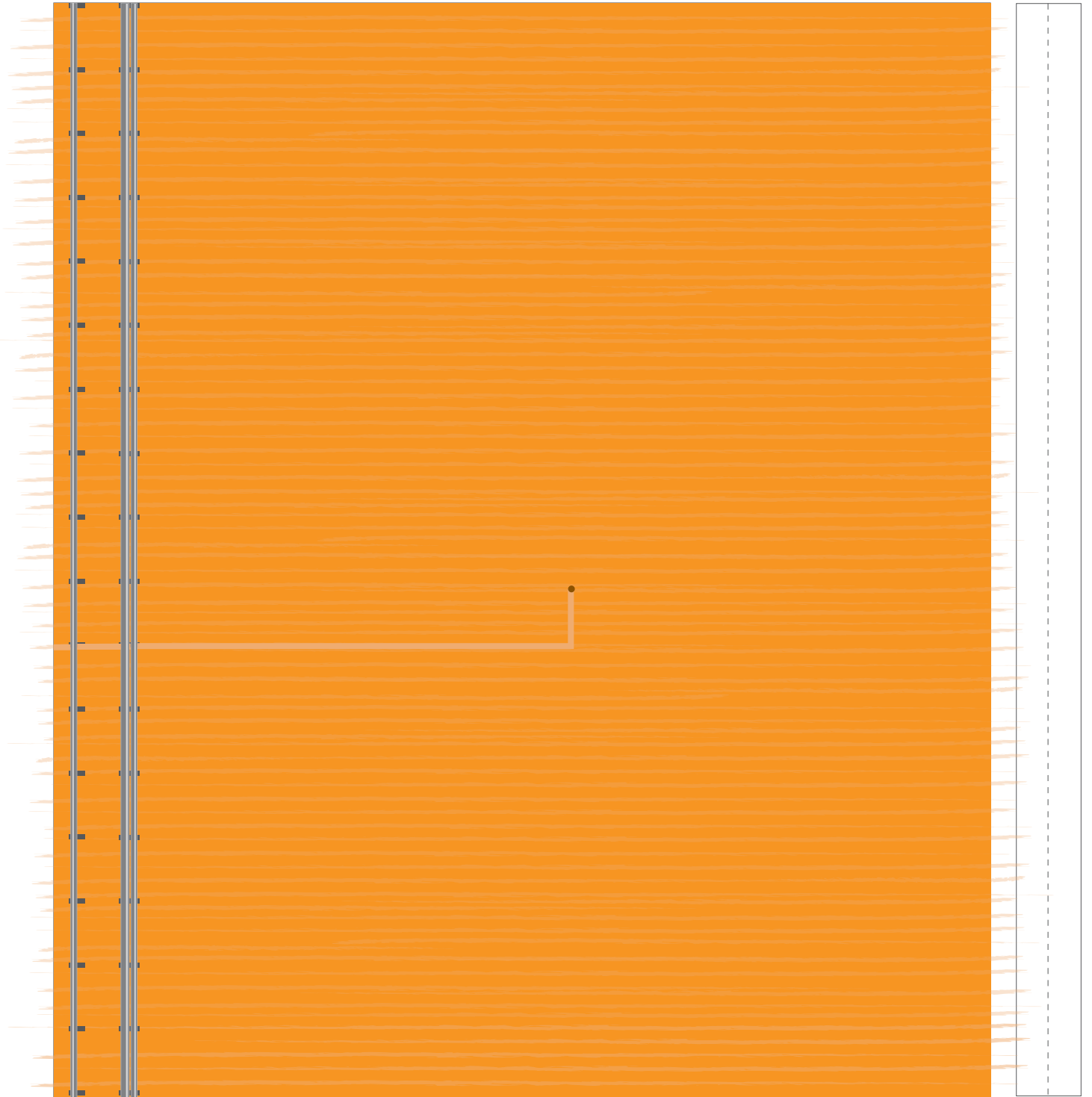

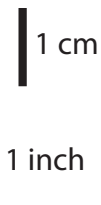

NROL-68

Print on Cardstock (110 lbs)

# Delta IV Common Booster Core

## Left

1:96 Scale

Align nosecone seam

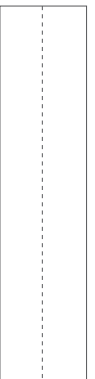
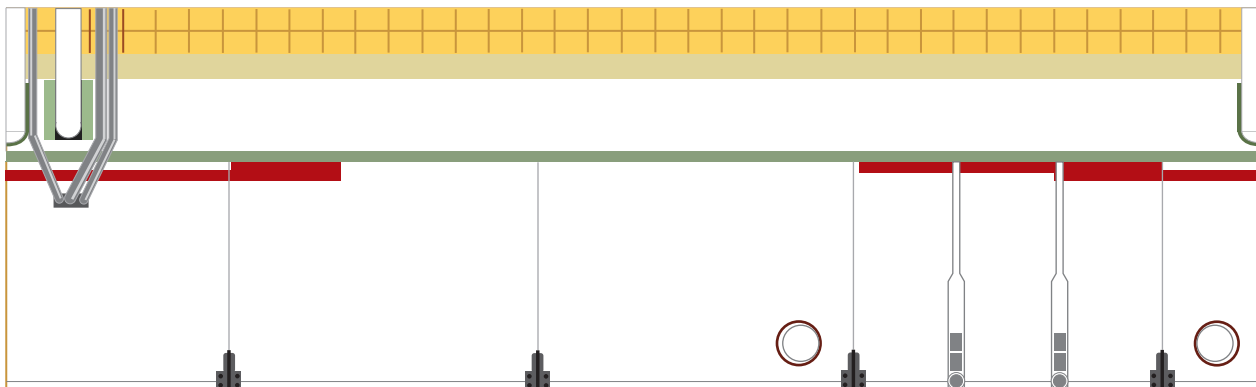
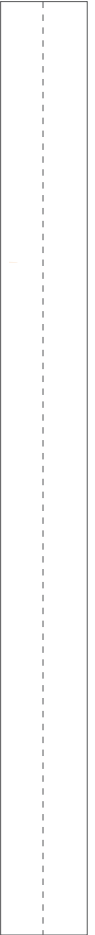
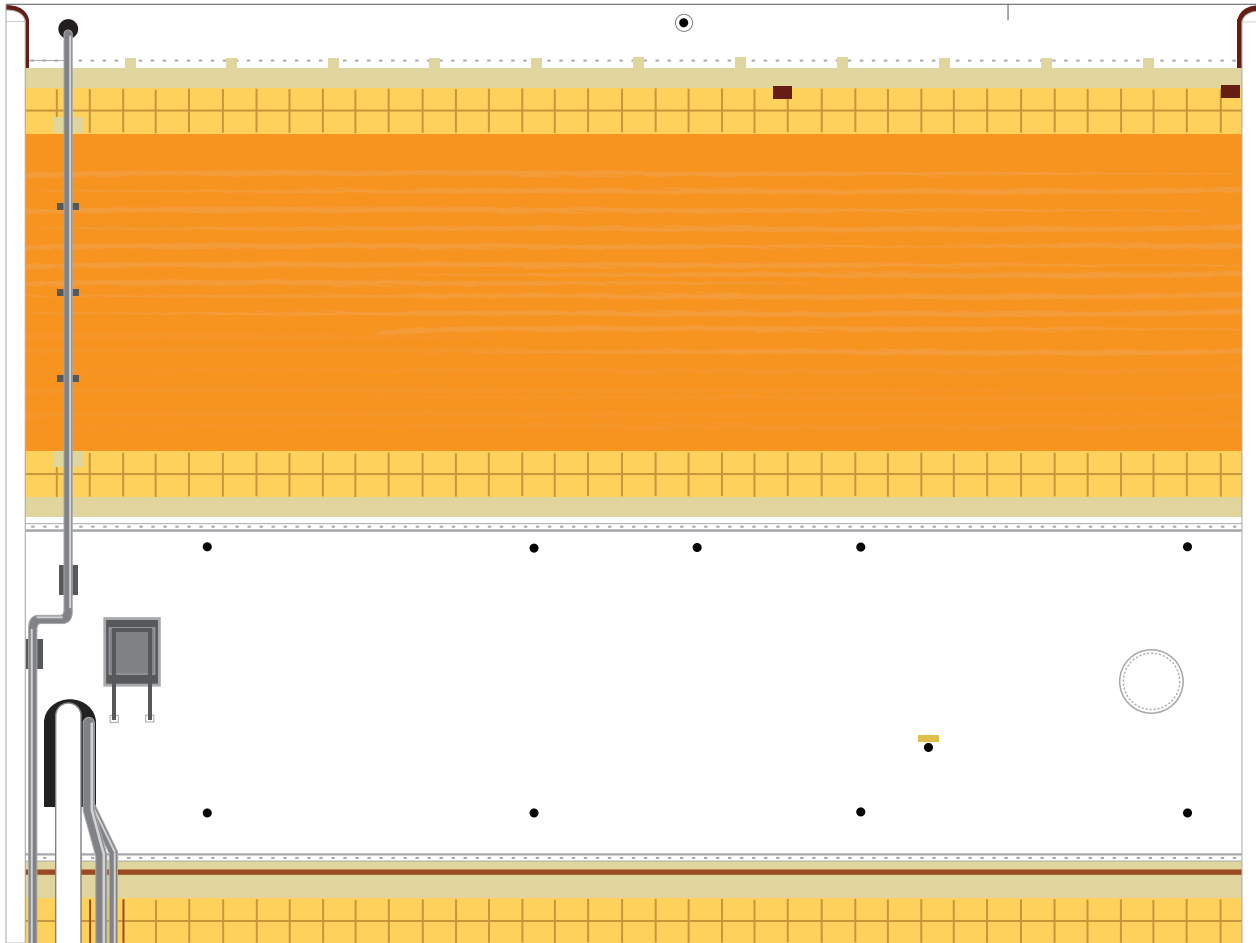



# Left Delta IV Common Booster Core

Print on Cardstock (110 lbs)

1:96 Scale

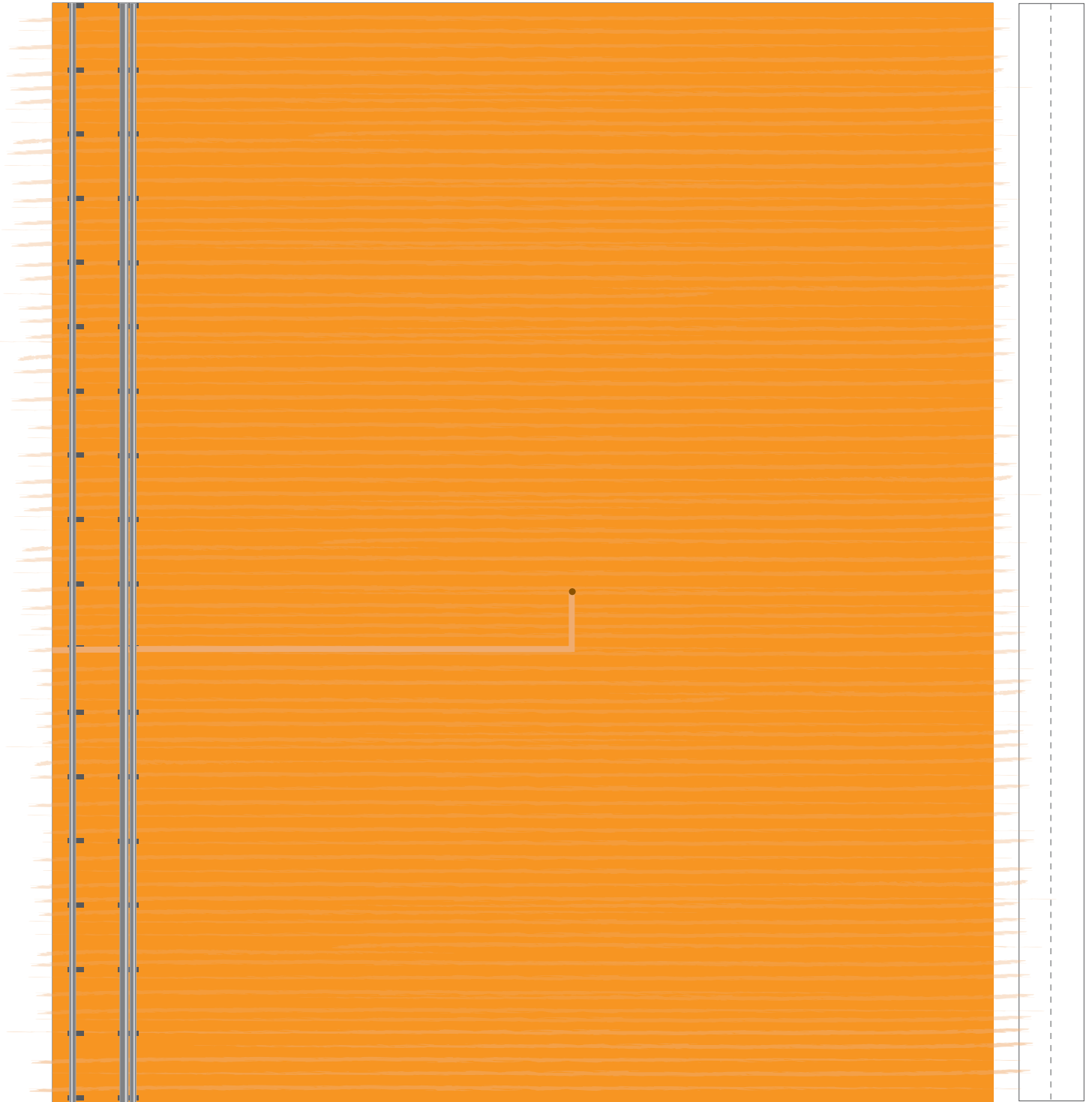

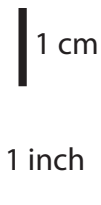

NROL-68

Print on Cardstock (110 lbs)

# Delta IV Common Booster Core Right

1:96 Scale

Align nosecone seam

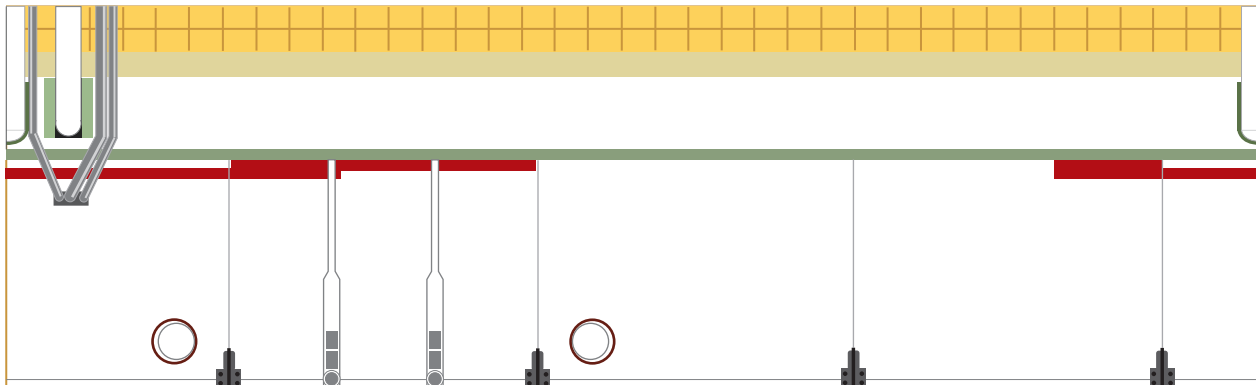
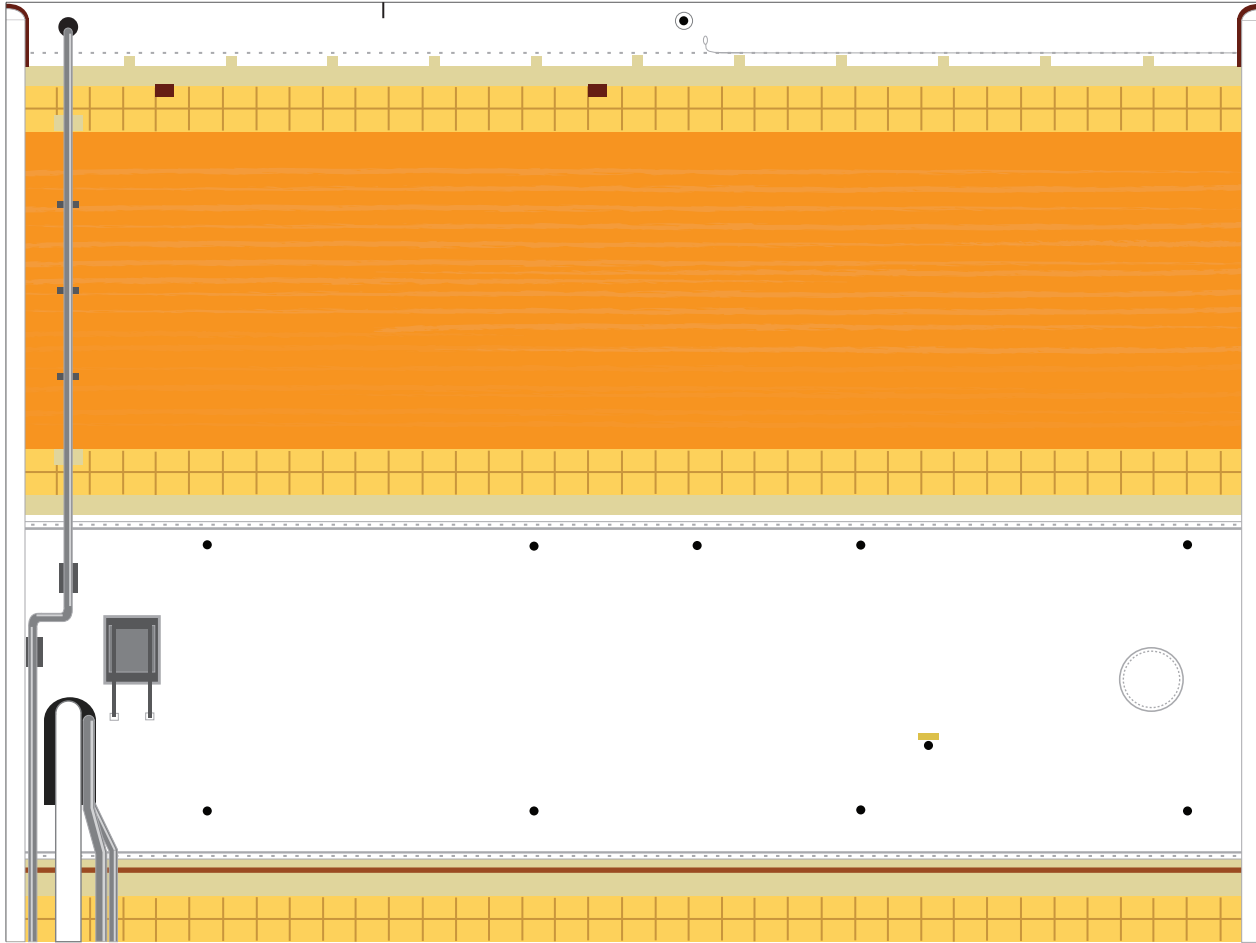



# Right Delta IV Common Booster Core

Print on Cardstock (110 lbs)

1:96 Scale

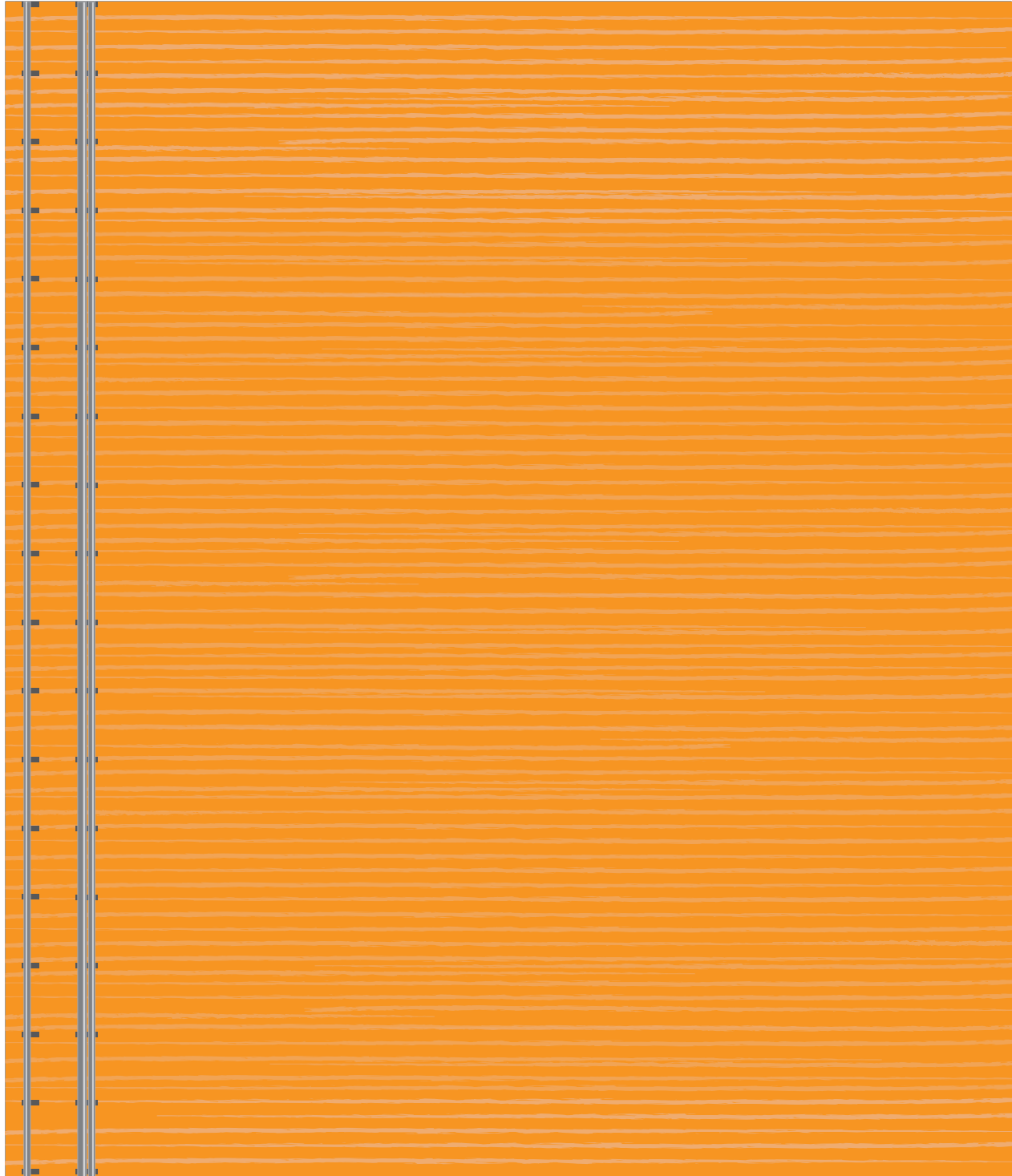



Print on Cardstock (110 lbs)

# Delta IV Common Booster Core Nosecone

Print X 2

1:96 Scale

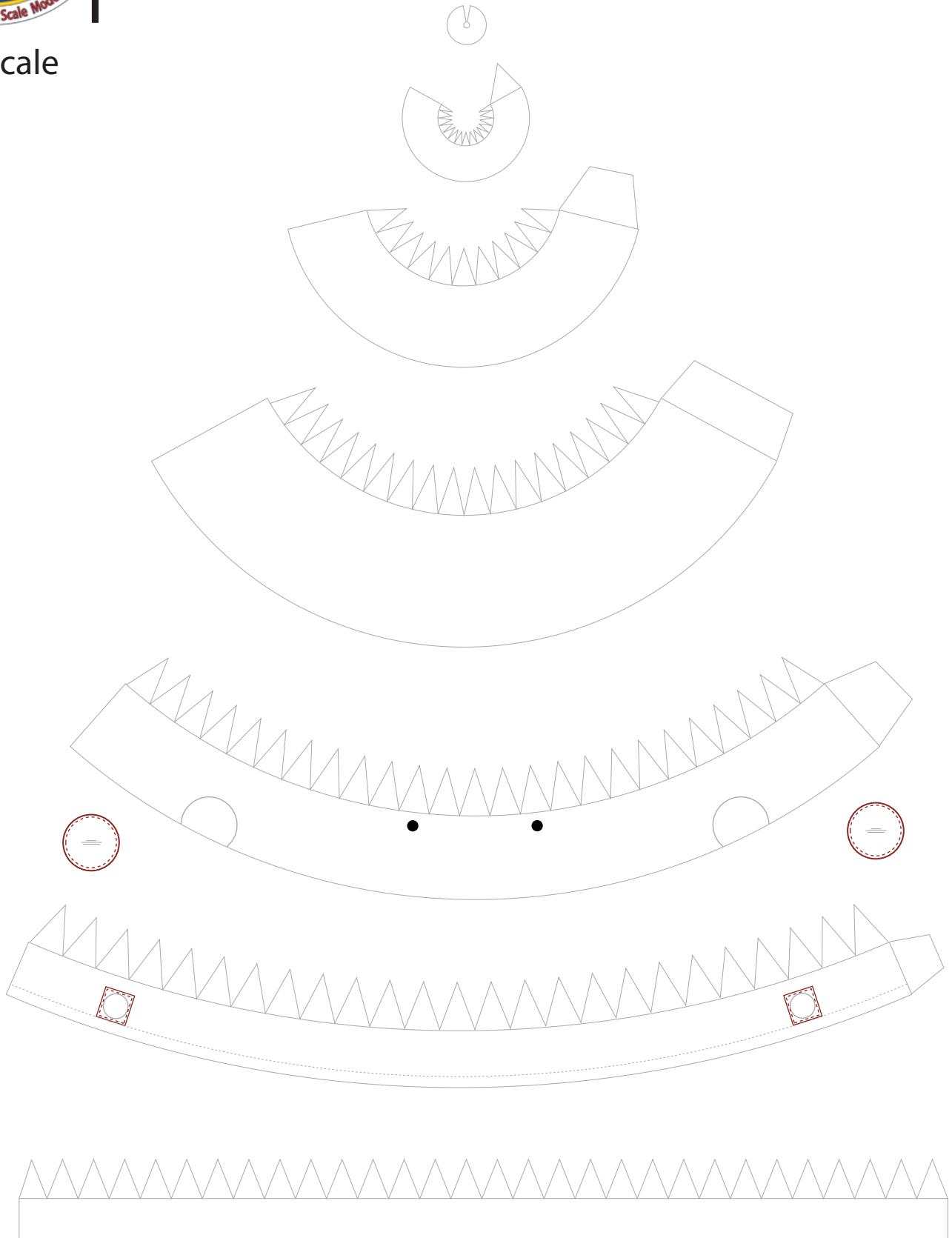

Connector for Common Booster Core



1 cm  
1 inch

# Delta IV Common Booster Core Attachments

Print on Cardstock (110 lbs)

1:96 Scale

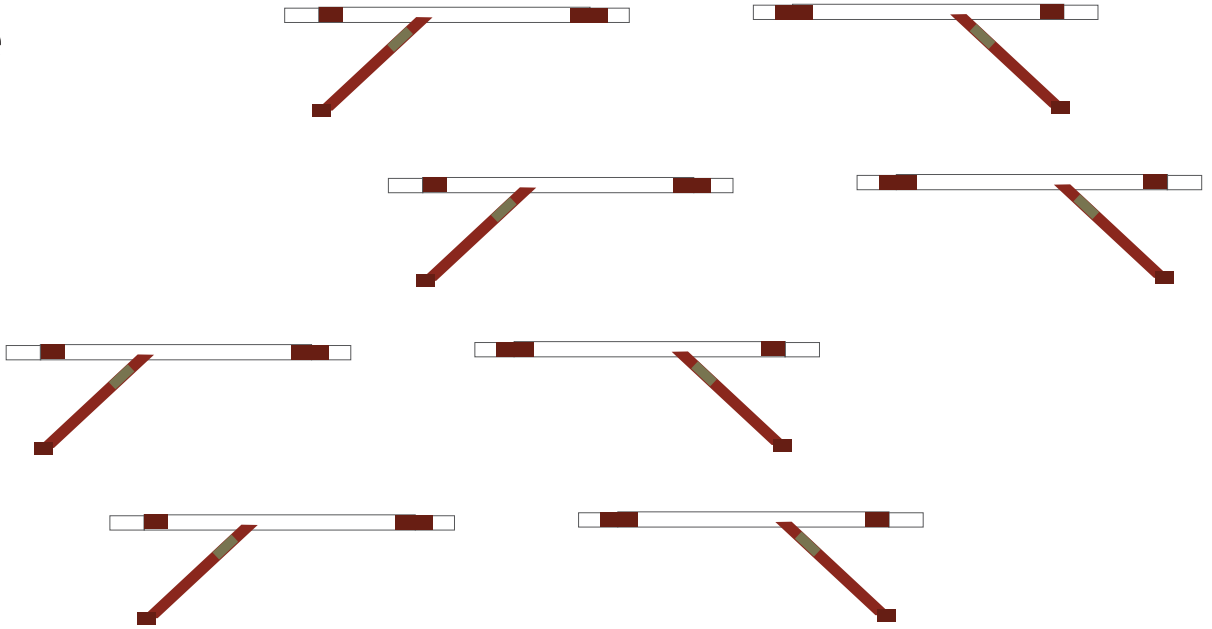

Center CBC  
INTERSTAGE

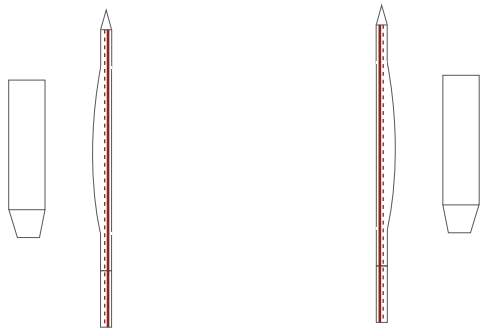

L CBC

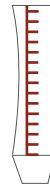

R CBC



L CBC lower  
attachments

R CBC lower  
attachments

Center CBC lower attachments

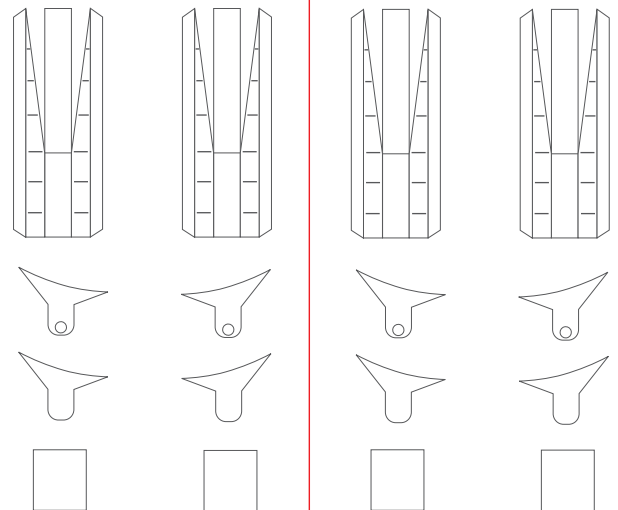
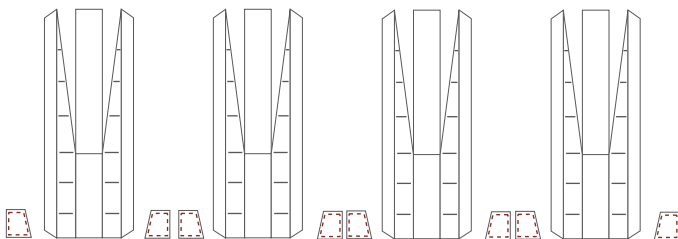



# Delta IV Common Booster Core Connectors

Print on Cardstock (110 lbs)

1:96 Scale

Blank template for a connector piece with a dashed fold line.

Blank template for a connector piece with a dashed fold line.

Blank template for a connector piece with a dashed fold line.

Blank template for a connector piece with a dashed fold line.

Blank template for a connector piece with a dashed fold line.

Blank template for a connector piece with a dashed fold line.

Blank template for a connector piece with a dashed fold line.





# Delta IV Common Booster Core

## Engine section

Print on Cardstock (110 lbs)

Print x 3

1:96 Scale

CBC bottom connector

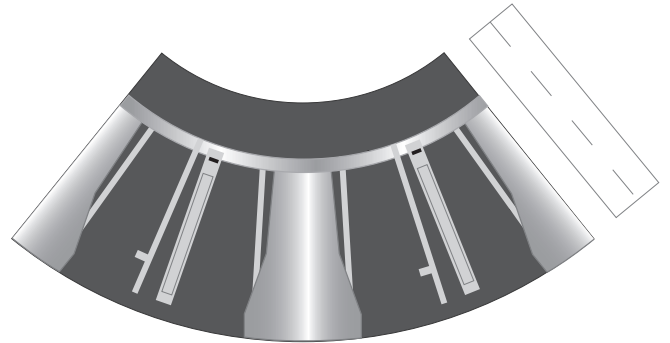
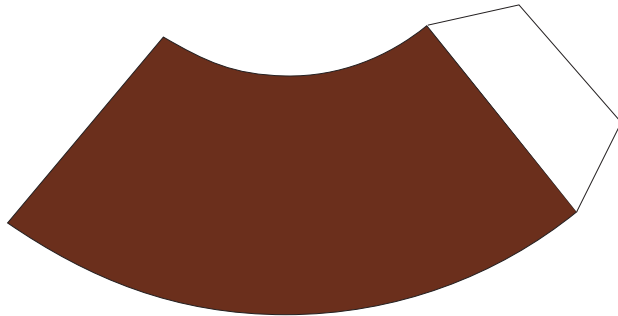
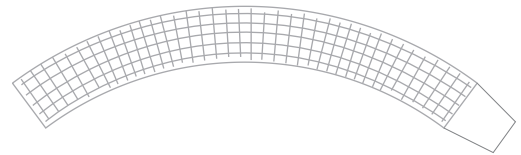
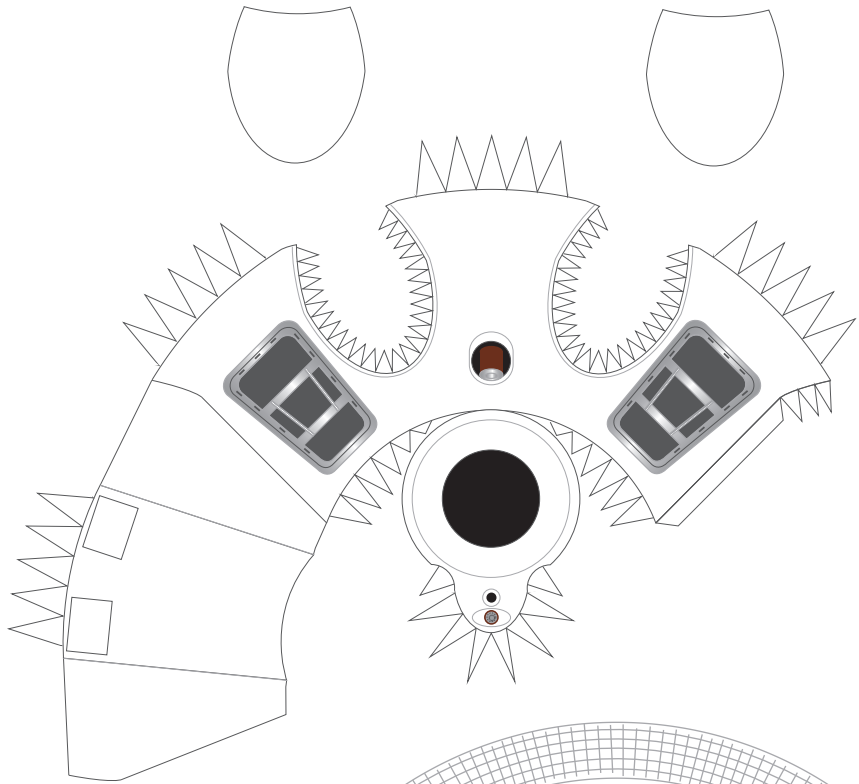
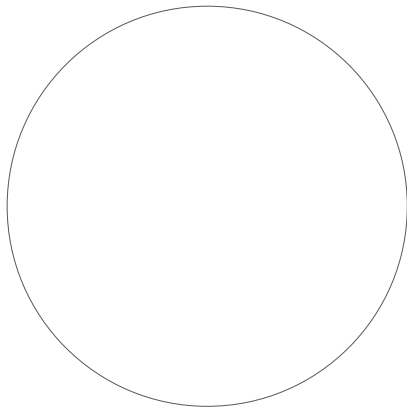
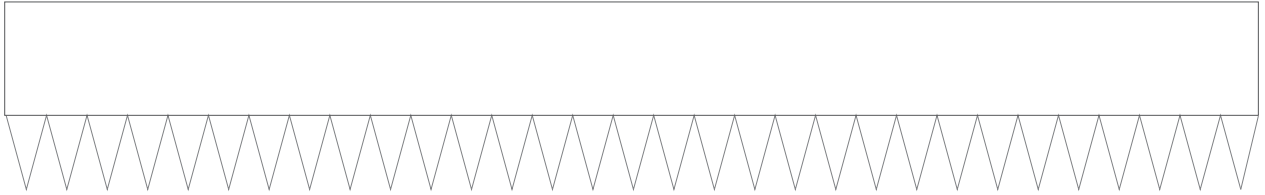



1 cm  
1 inch

# Delta IV Common Booster Core

## Fuel Lines

Print x 3



Print on Cardstock (110 lbs)

1:96 Scale

