

Salyut 7

Print on Cardstock (110 lbs)

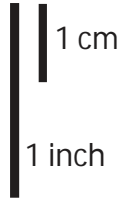

1:100 Scale

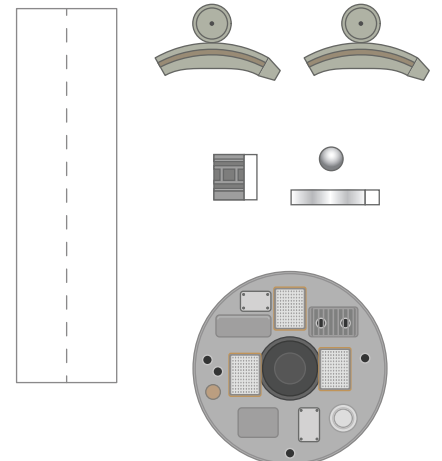
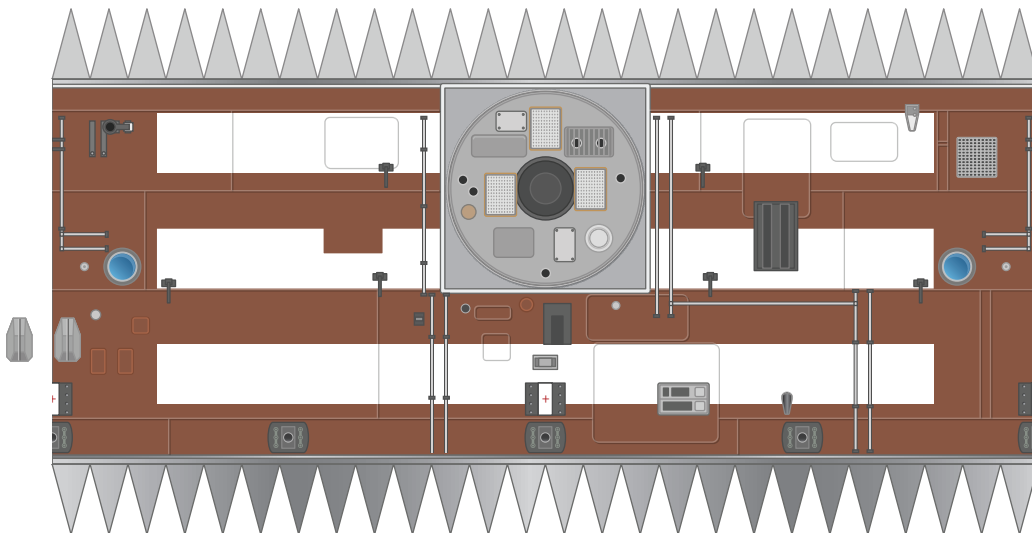
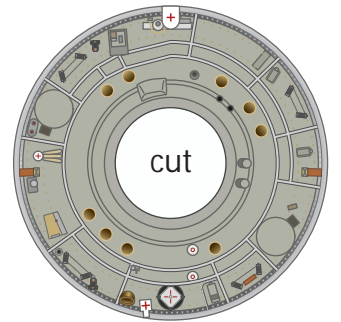
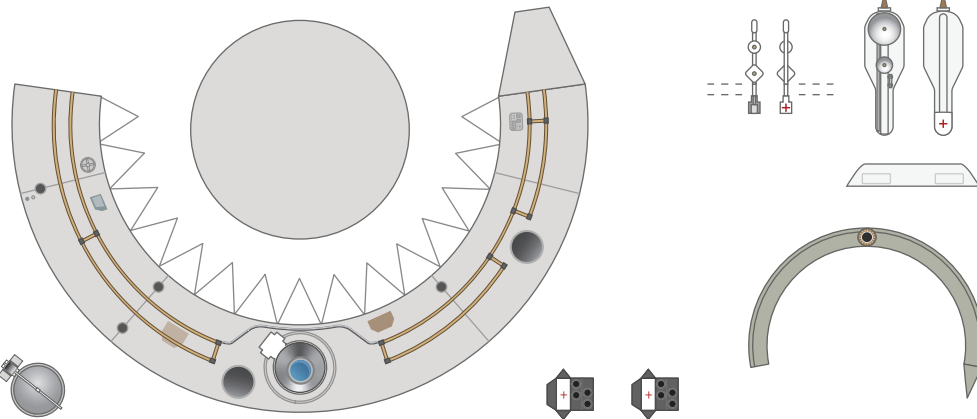
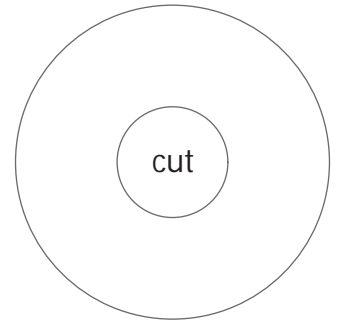
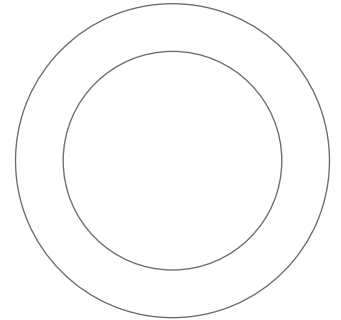
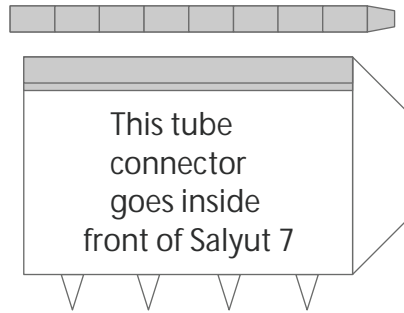
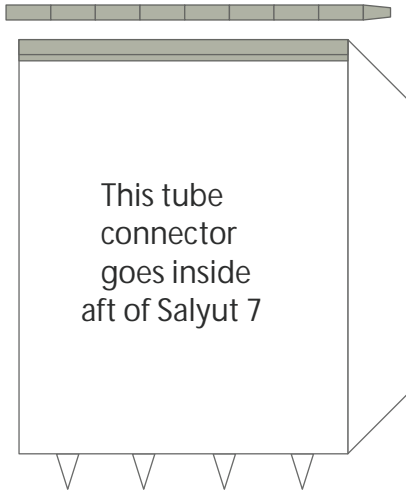
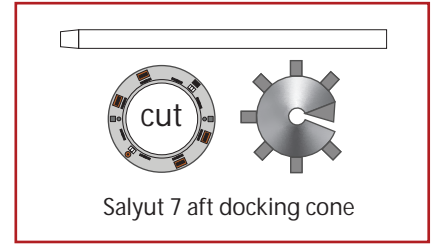
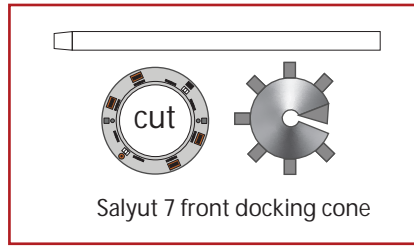

Salyut 7

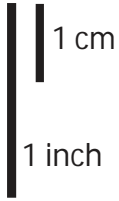

1:100 Scale

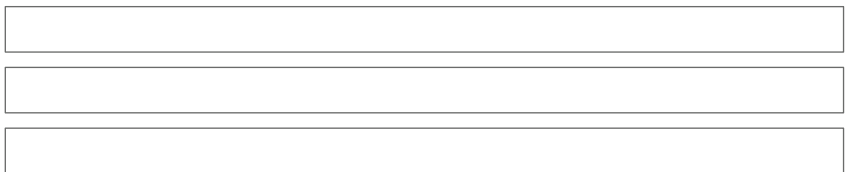
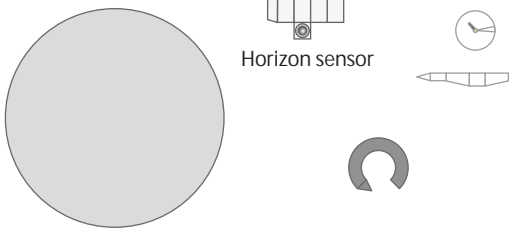
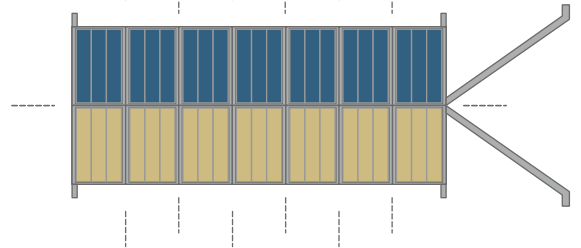
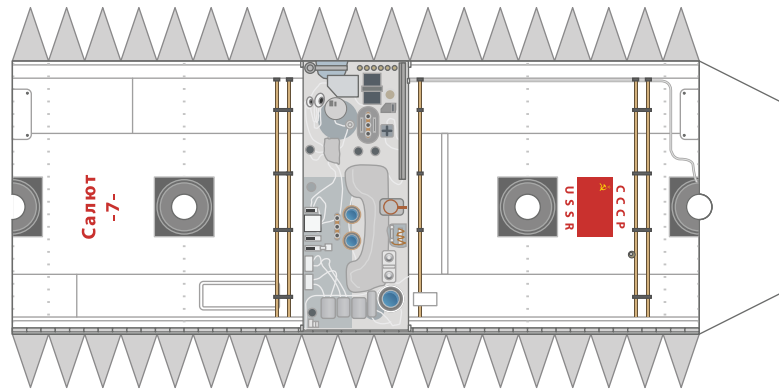
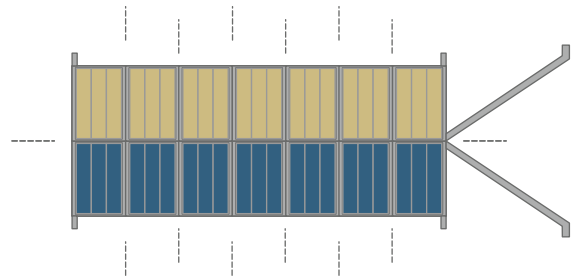
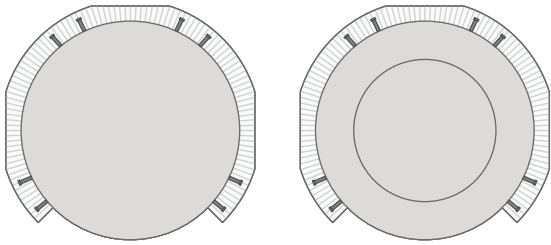
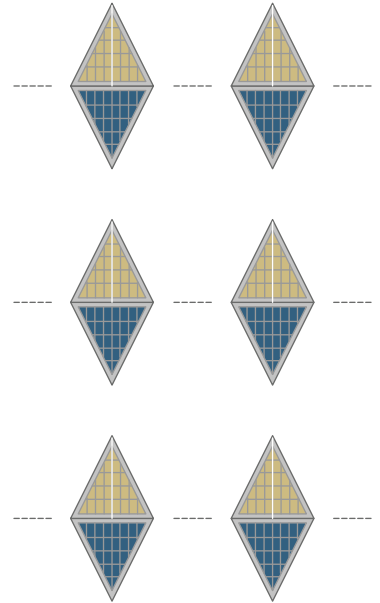
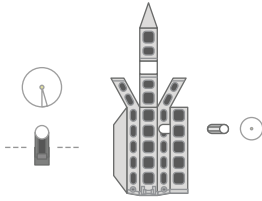
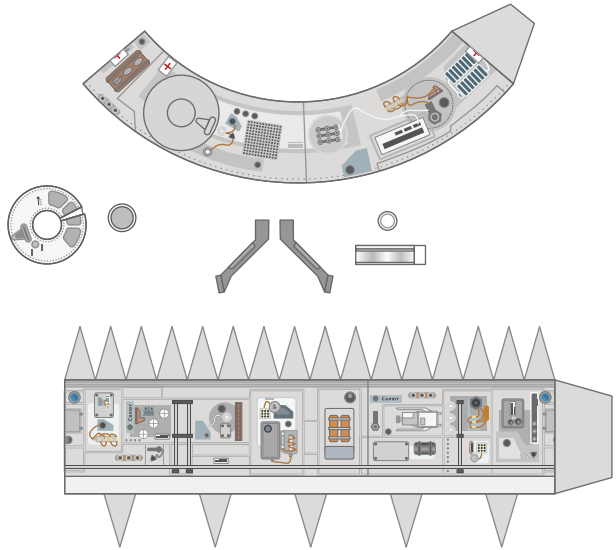

Roll each around a cotton swab
20mm

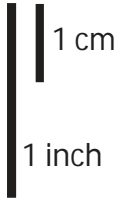

Salyut 7

Print on Cardstock (110 lbs)

1:100 Scale

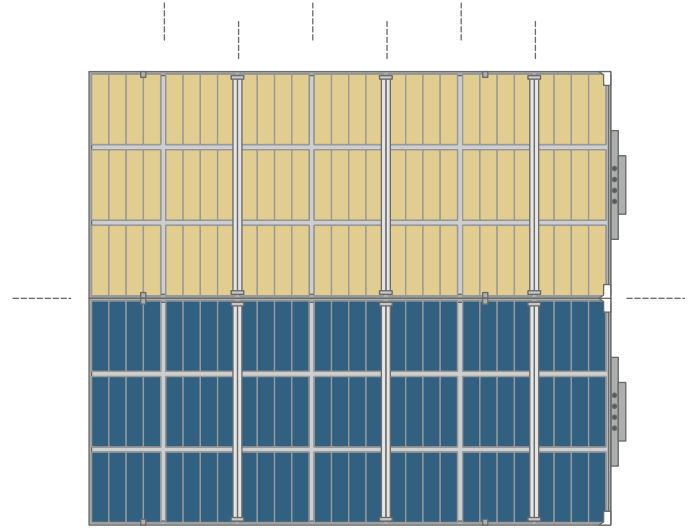
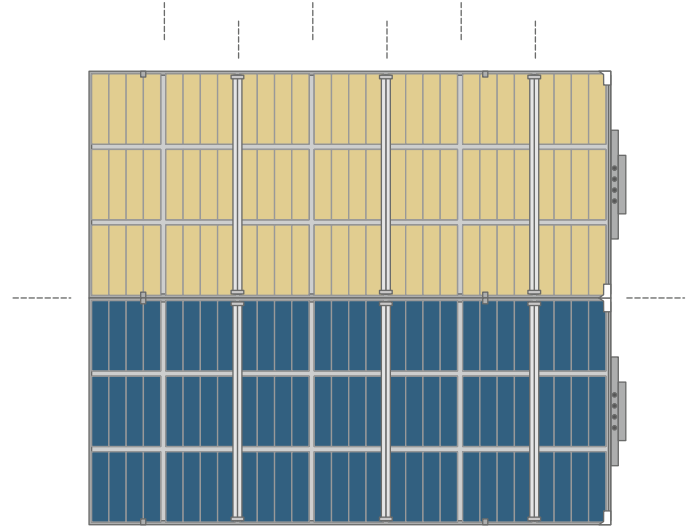
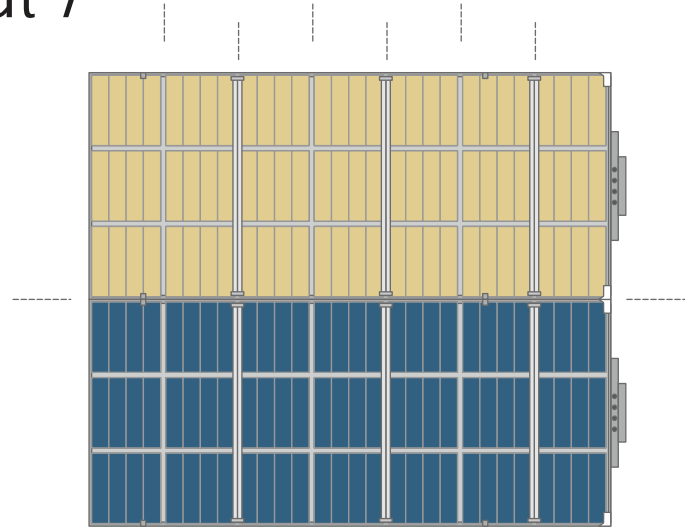
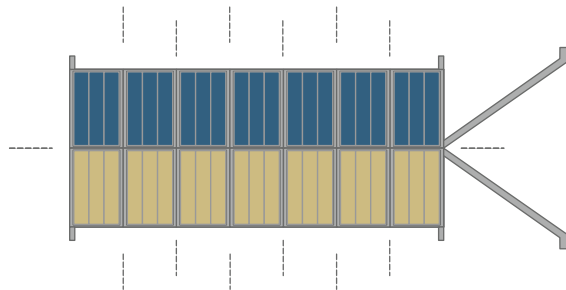
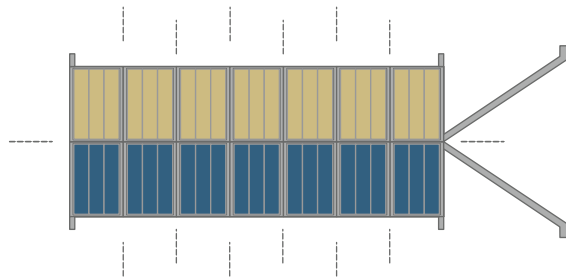
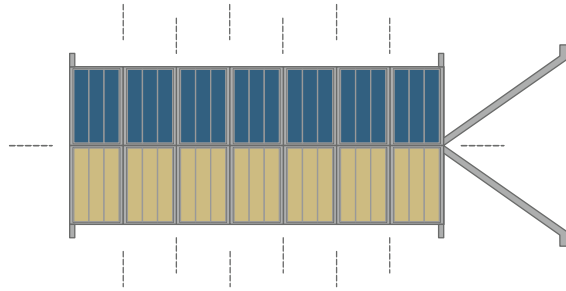
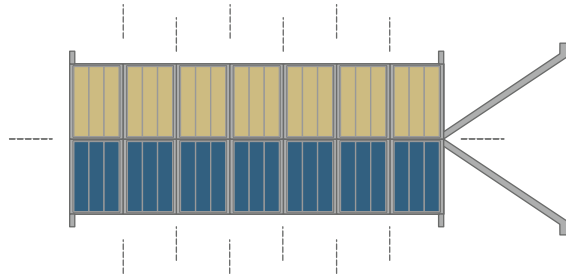

Soyuz - T

Print on Cardstock (110 lbs)

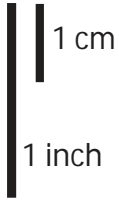

1:100 Scale

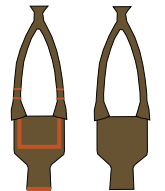
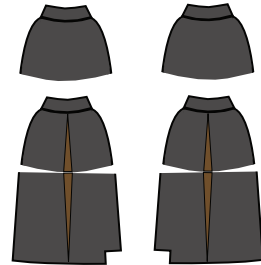
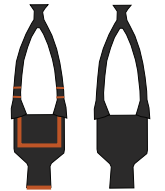
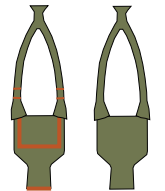
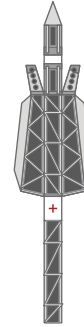
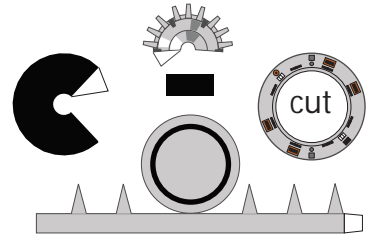
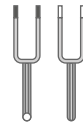
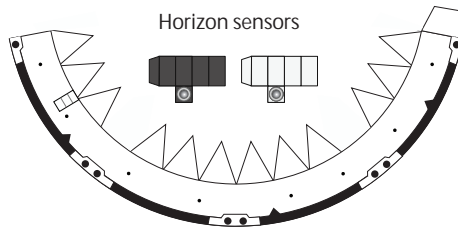
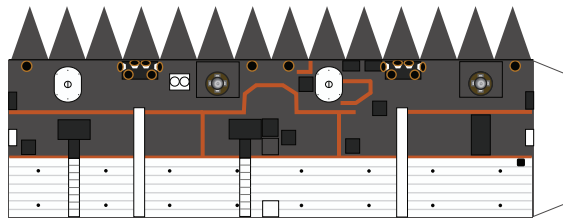
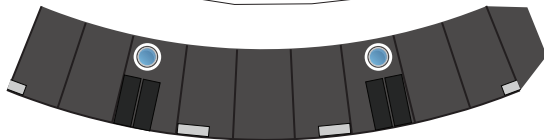
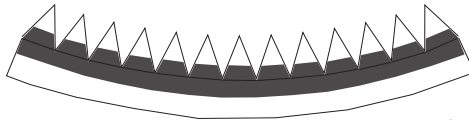
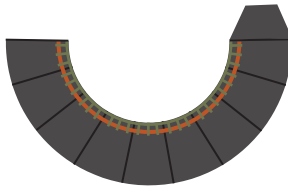
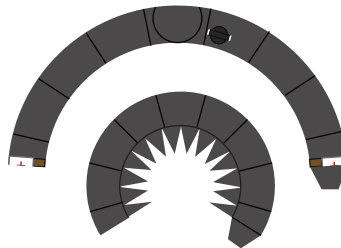
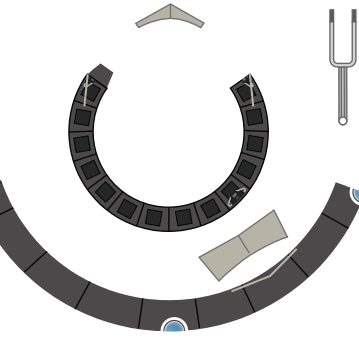
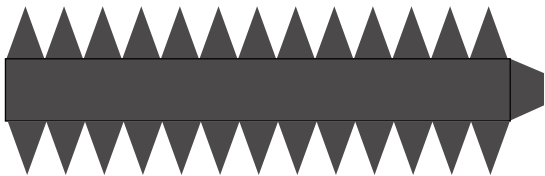
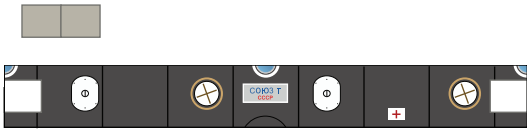

Use any color

Periscope

