



# Space Launch System (SLS)

Print on Cardstock (110 lbs)

## ARTEMIS Launch Abort System

1:96 Scale

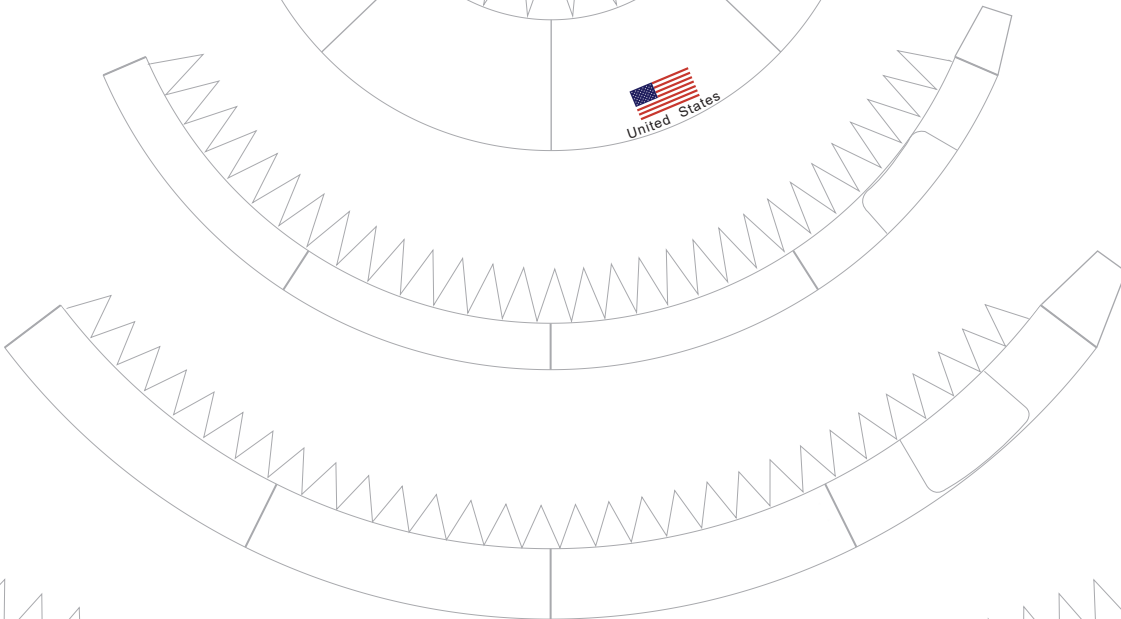
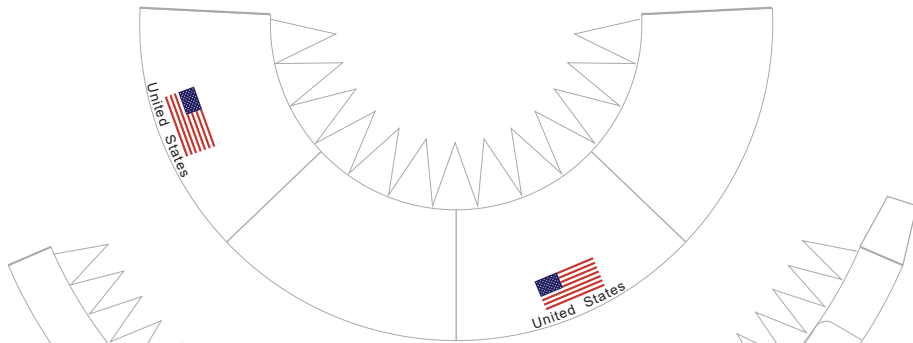
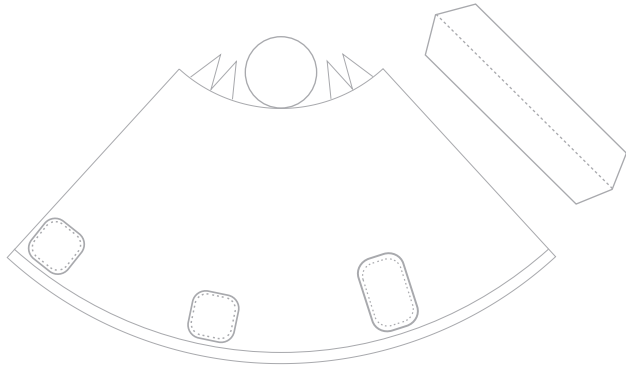
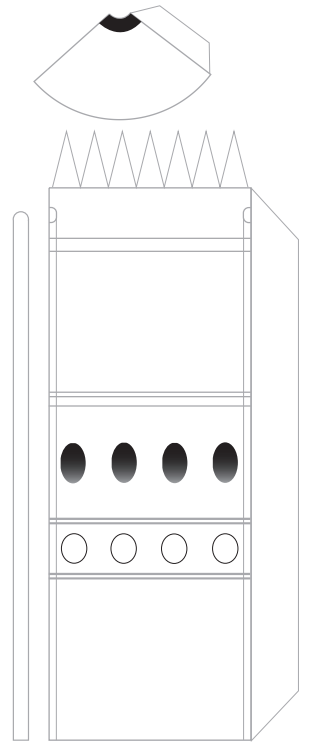
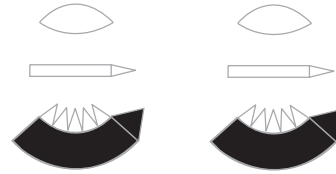
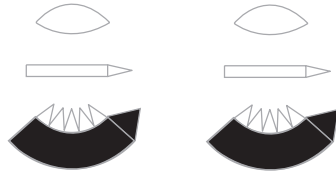



# Space Launch System (SLS)

Print on Cardstock (110 lbs)

## ARTEMIS

1 cm

1 inch

Only for closed LAS/Orion configuration

1:96 Scale

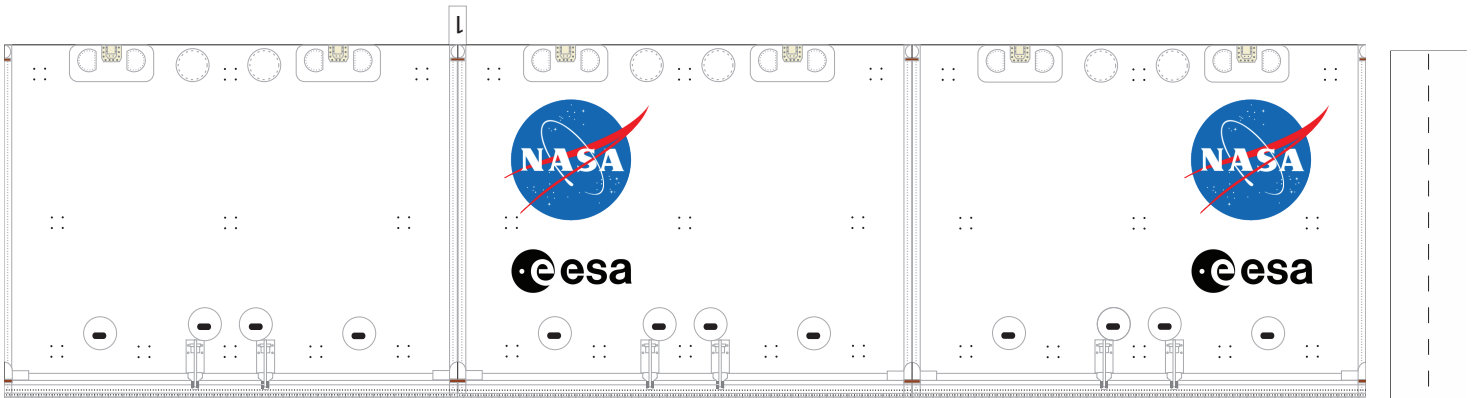
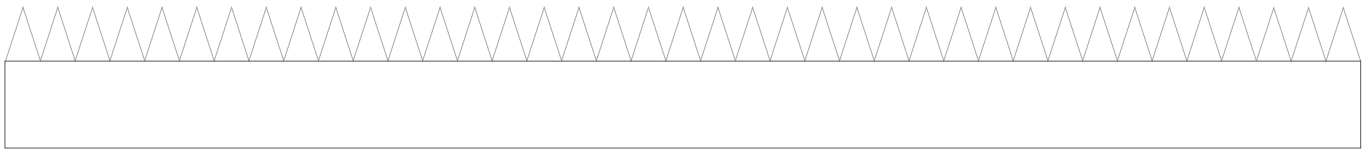
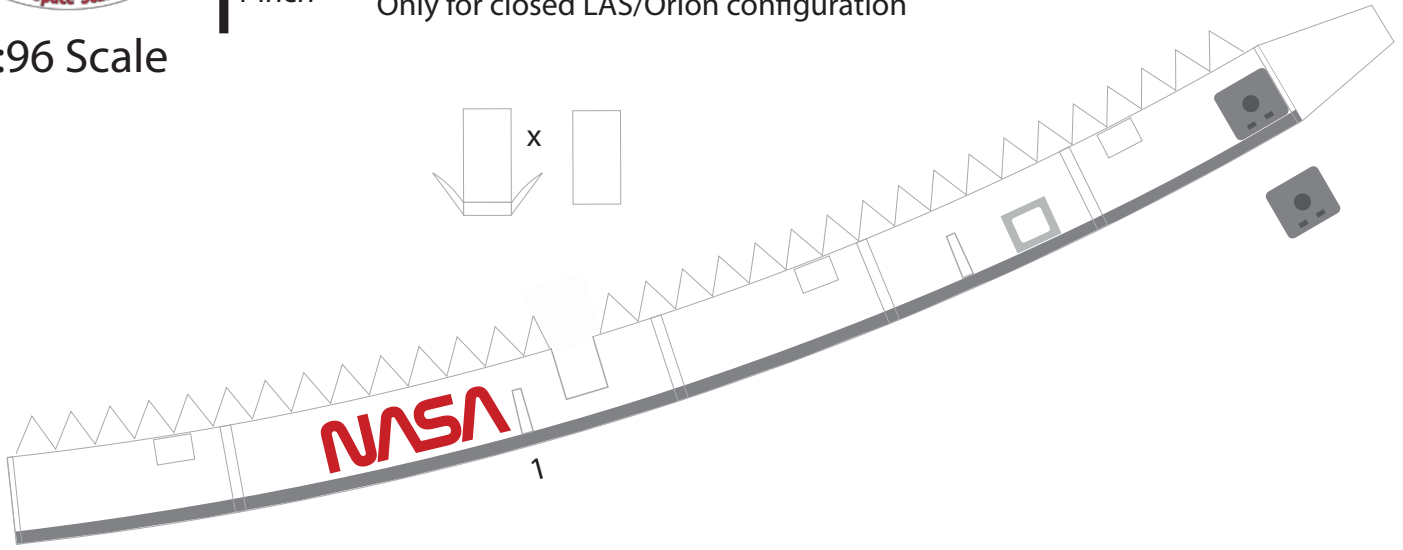
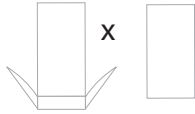



# Space Launch System (SLS)

Print on Cardstock (110 lbs)

Connector between Service Module and Second Stage

## ARTEMIS

Only for closed LAS/Orion configuration

1:96 Scale

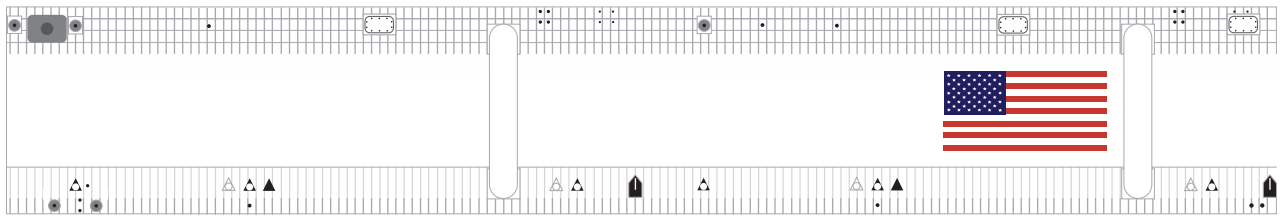
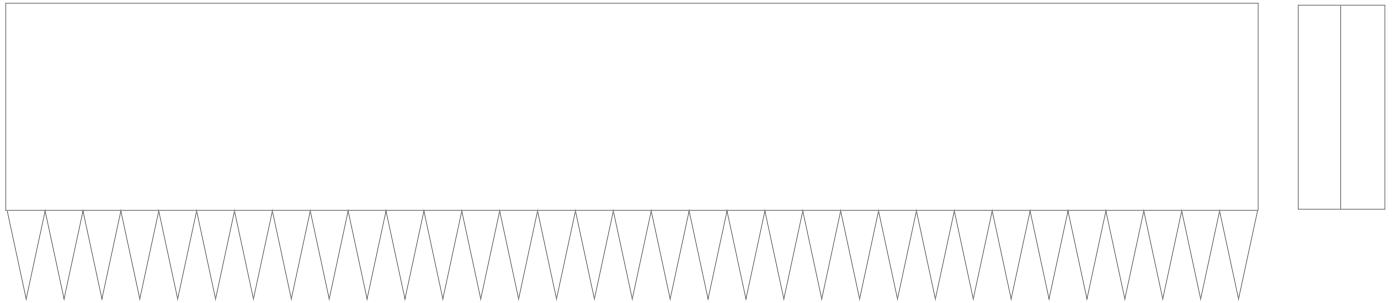
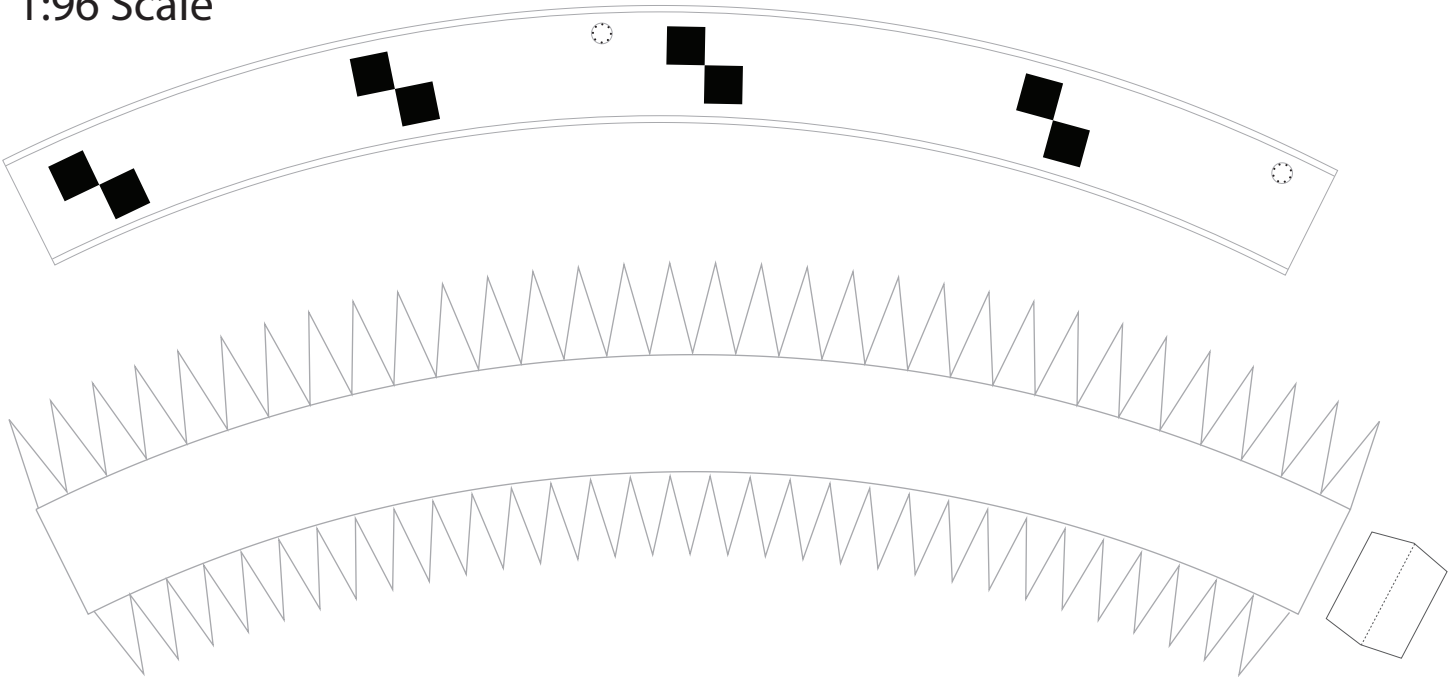



Space Launch System (SLS)

Print on Cardstock (110 lbs)

# ARTEMIS

1:96 Scale



Front logos

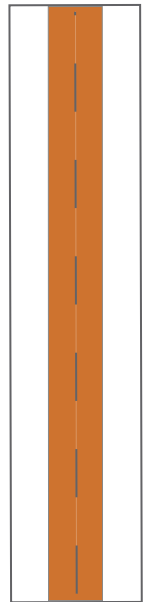
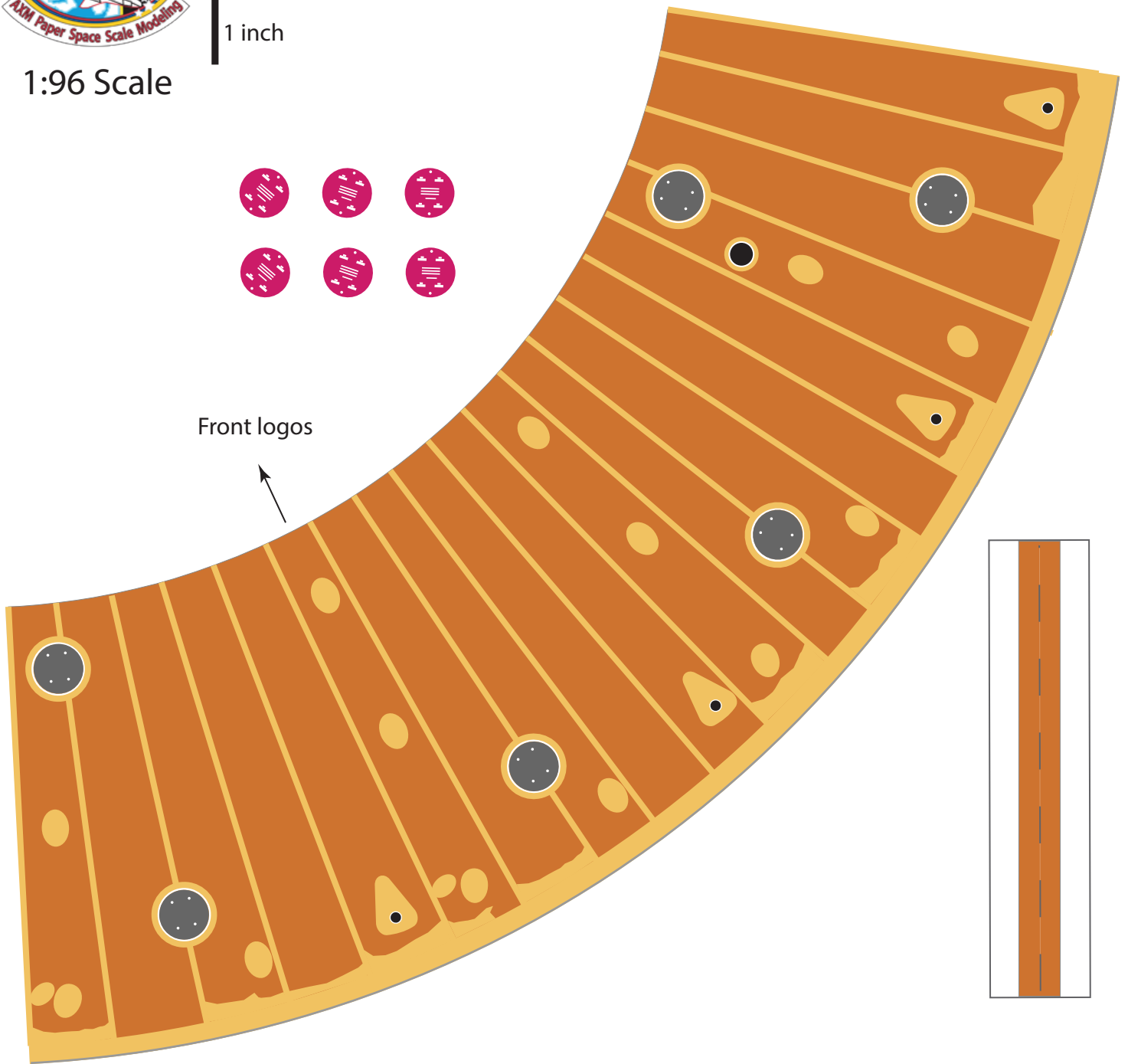



1:96 Scale

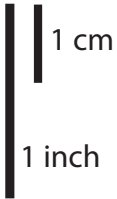

Space Launch System (SLS)

Print on Cardstock (110 lbs)

# ARTEMIS

Curved support to be  
glued inside the LVSA

LVSA connector / Core Stage

Do not glue this connector  
to the Core.  
It is designed to snap in place.



Space Launch System (SLS)

Print on Cardstock (110 lbs)

# ARTEMIS

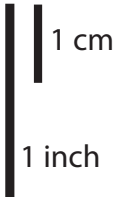

# E

1:96 Scale

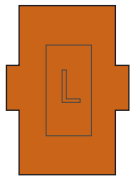
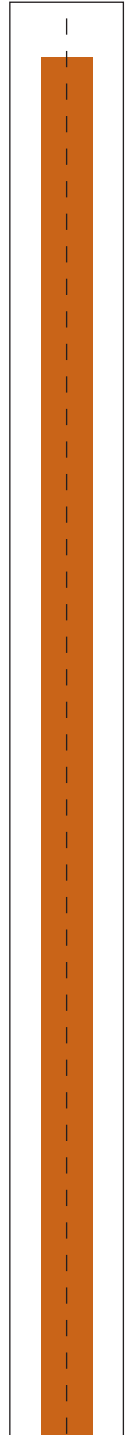
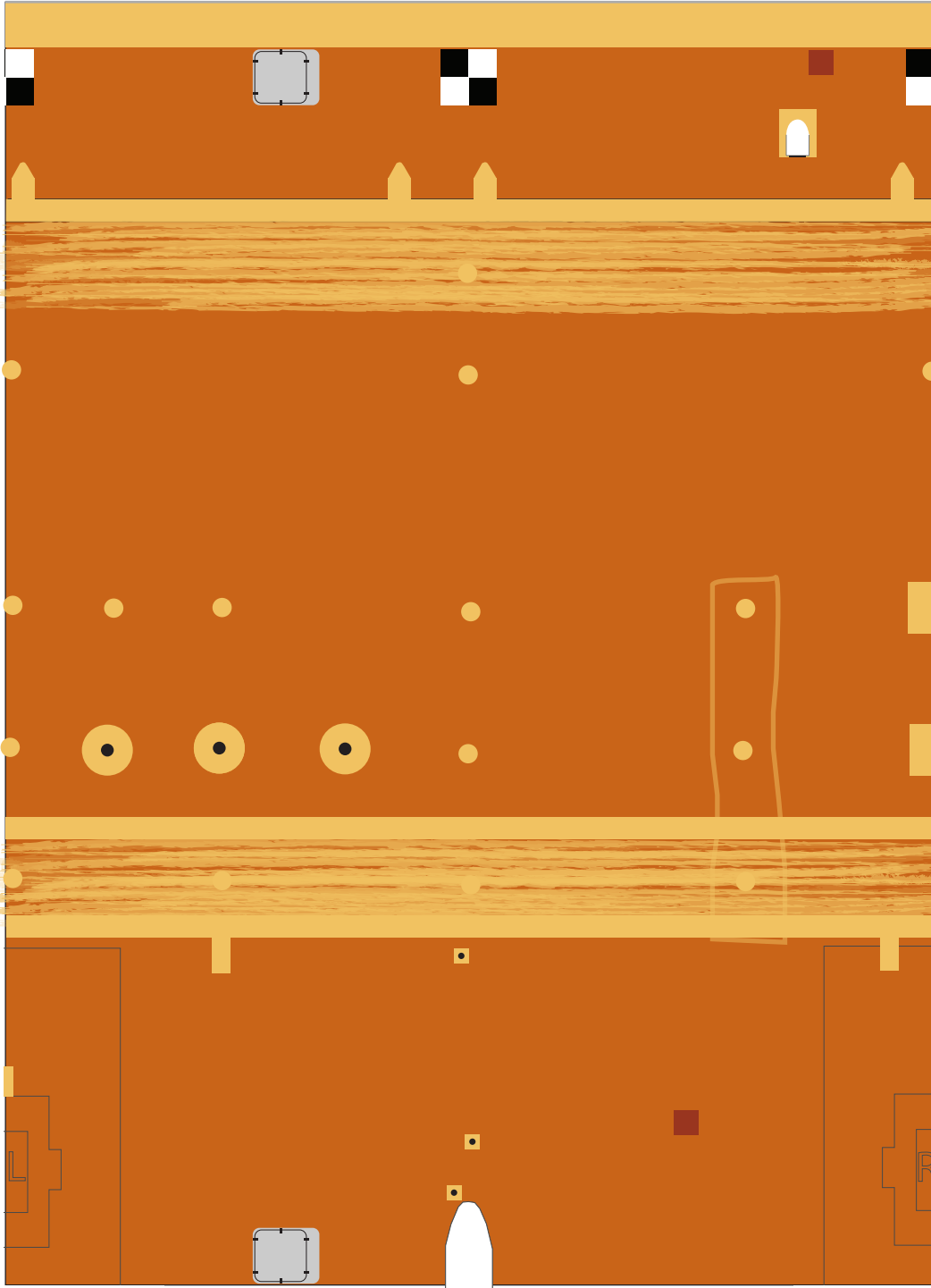



# Space Launch System (SLS)

Print on Cardstock (110 lbs)

## ARTEMIS

1:96 Scale

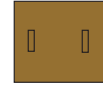
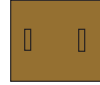

# F

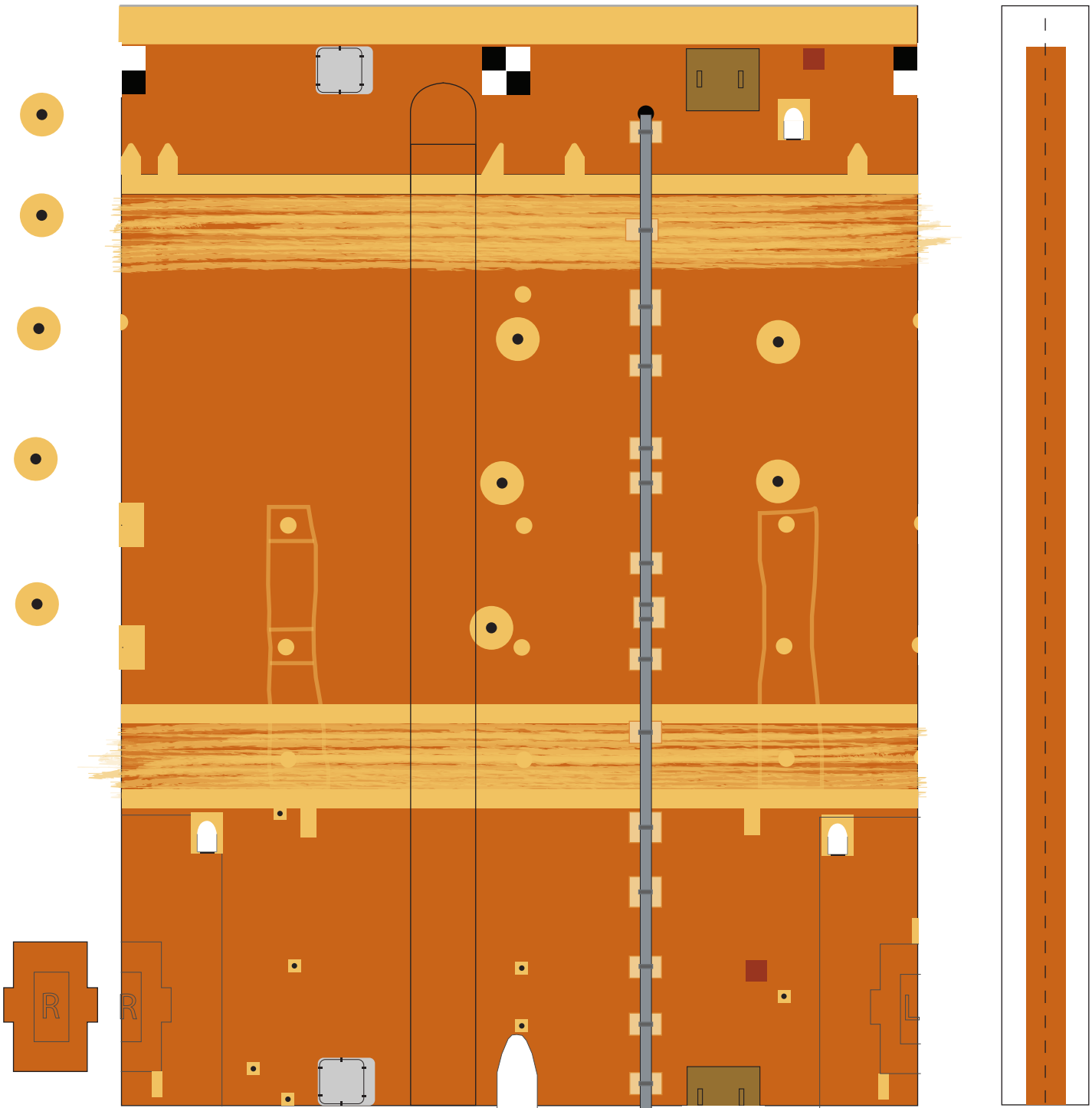



Space Launch System (SLS)

Print on Cardstock (110 lbs)

ARTEMIS

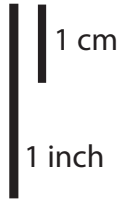

1:96 Scale



C

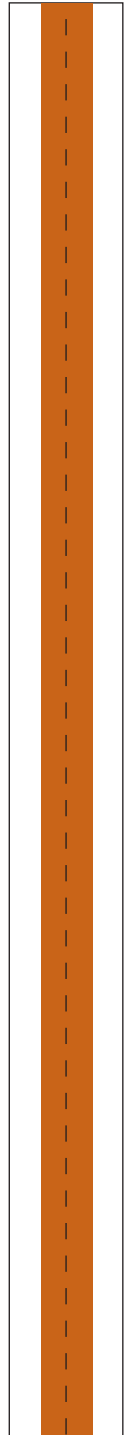
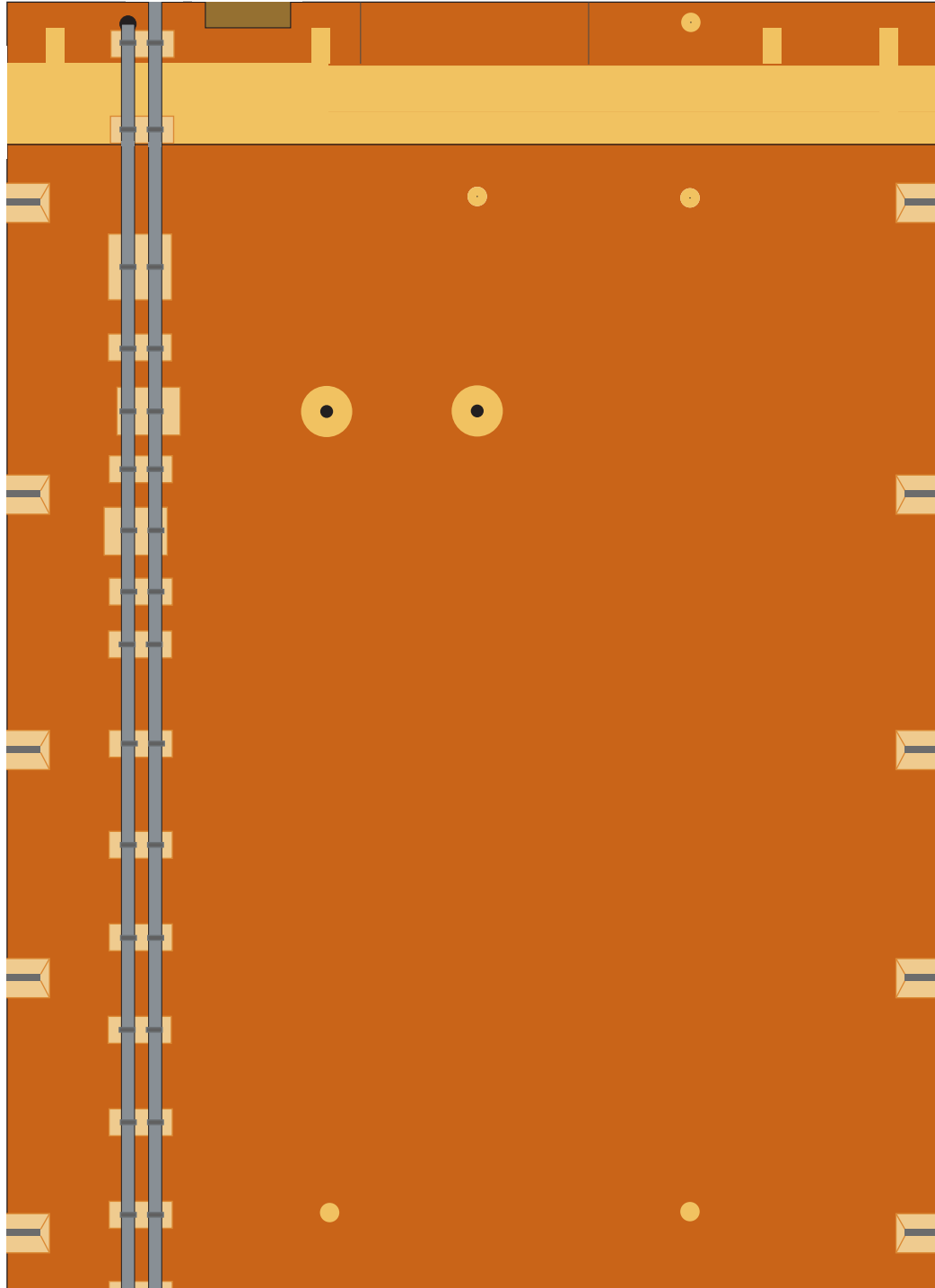





Space Launch System (SLS)

Print on Cardstock (110 lbs)

# ARTEMIS

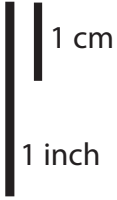

1:96 Scale

# D

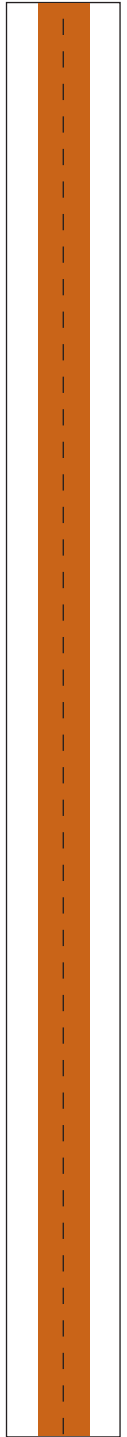
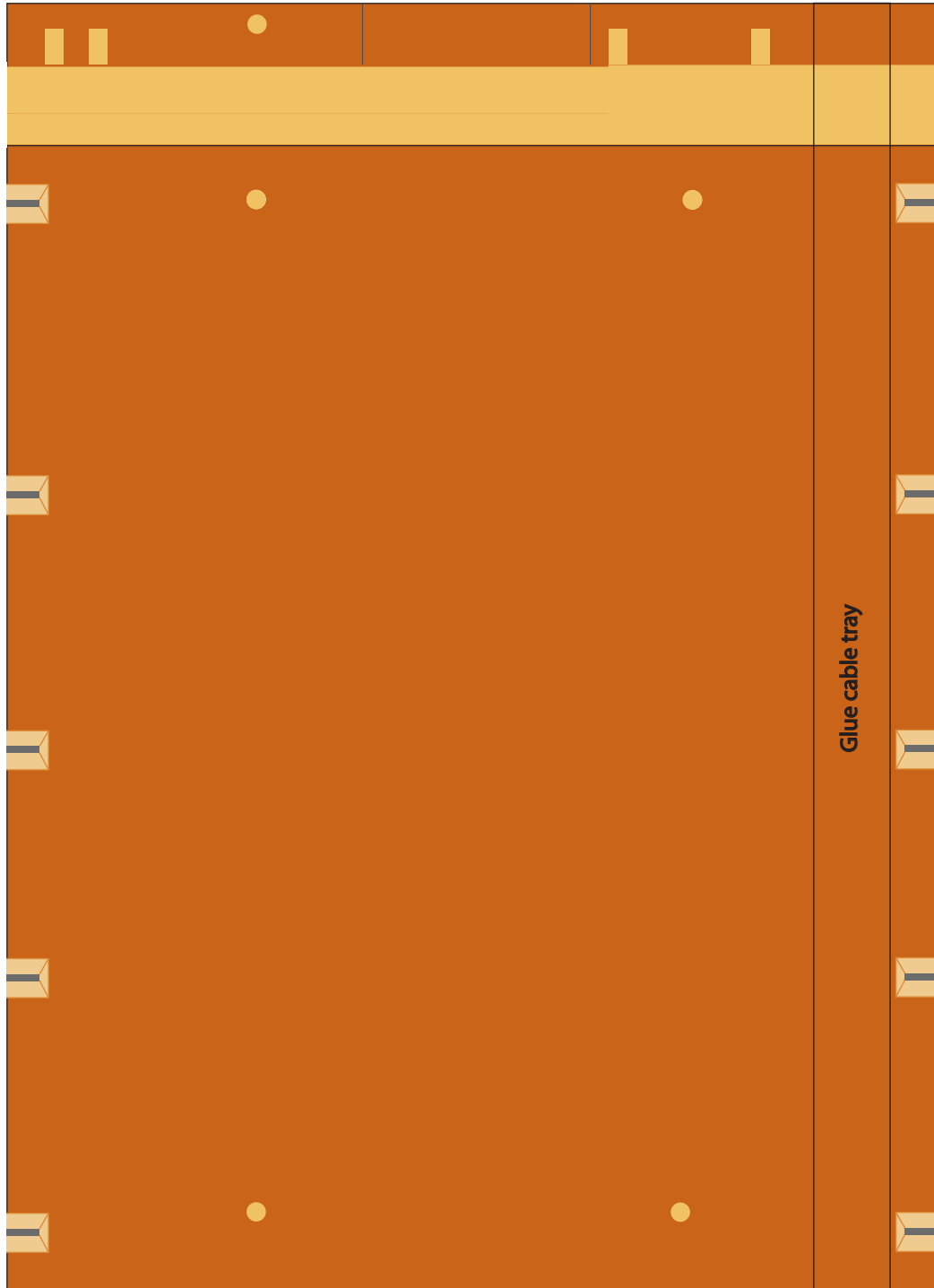



Space Launch System (SLS)

Print on Cardstock (110 lbs)

# ARTEMIS

1:96 Scale



# A

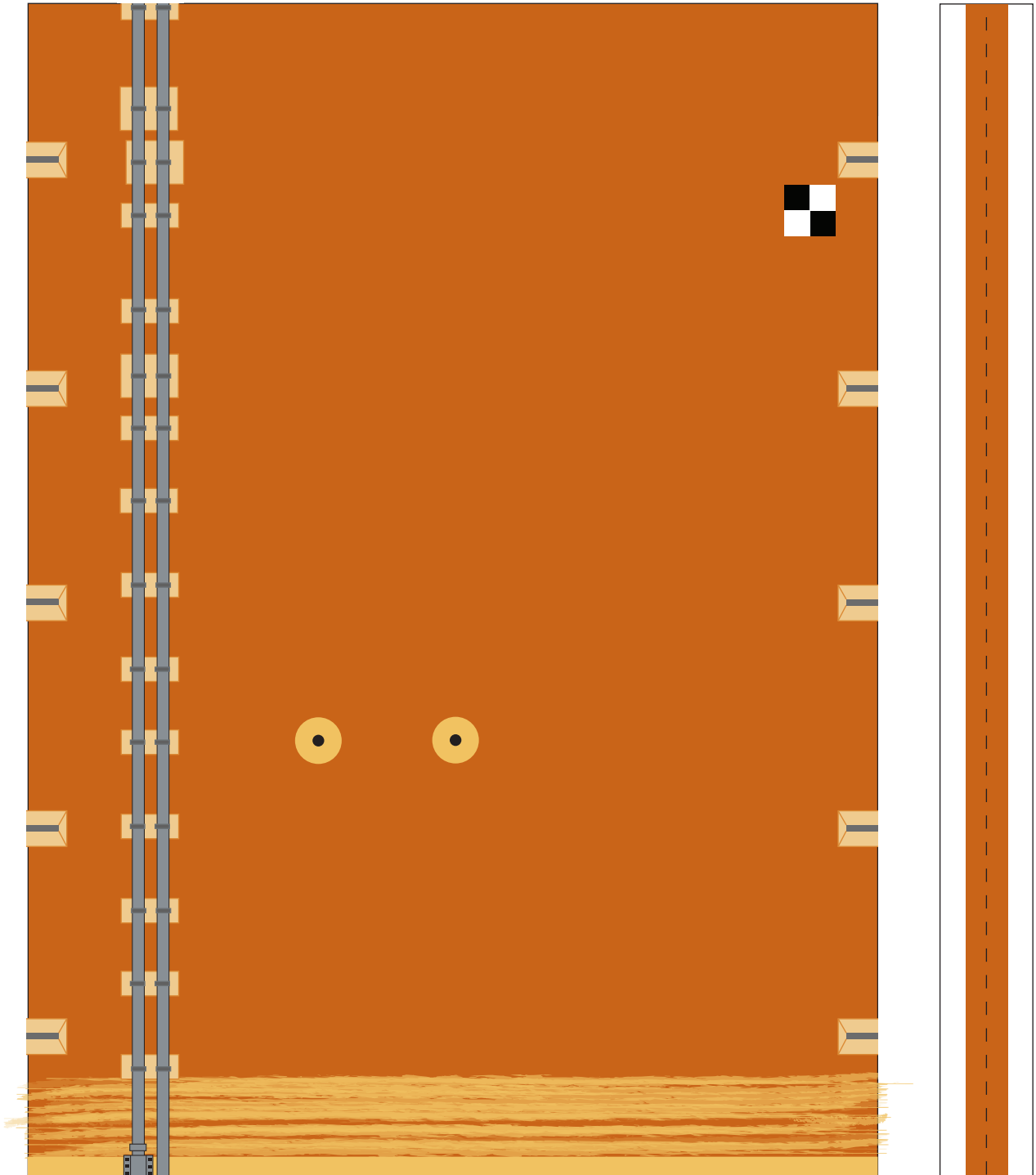



Space Launch System (SLS)

Print on Cardstock (110 lbs)

# ARTEMIS

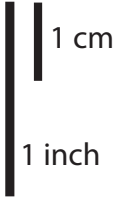

1:96 Scale

# B

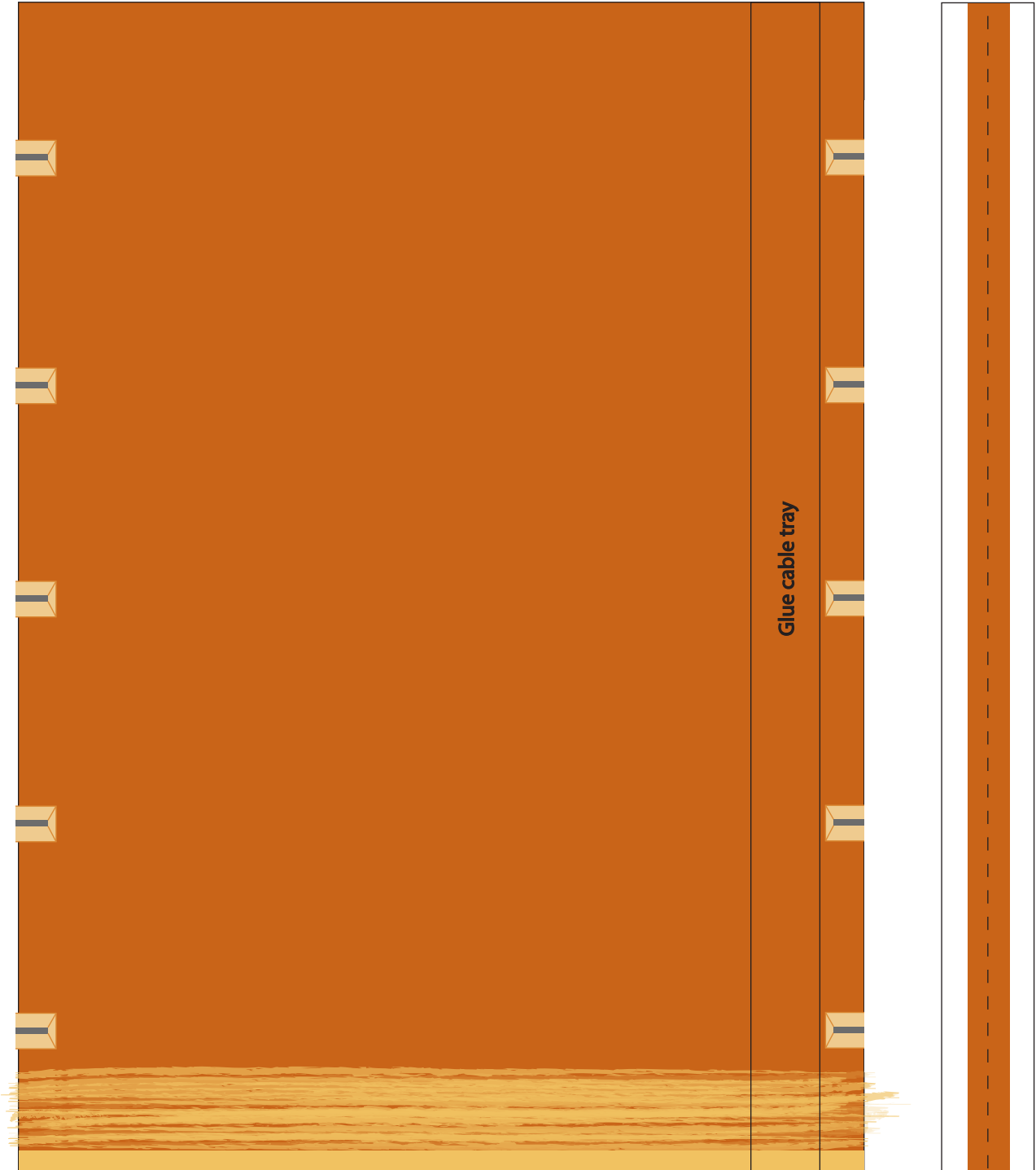



# Important! Print on Paper only

## Space Launch System (SLS)

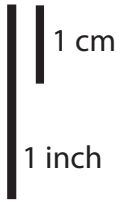

1:96 Scale

Use a rod or wooden dowel  
3/16 in (4.76 mm) in diameter

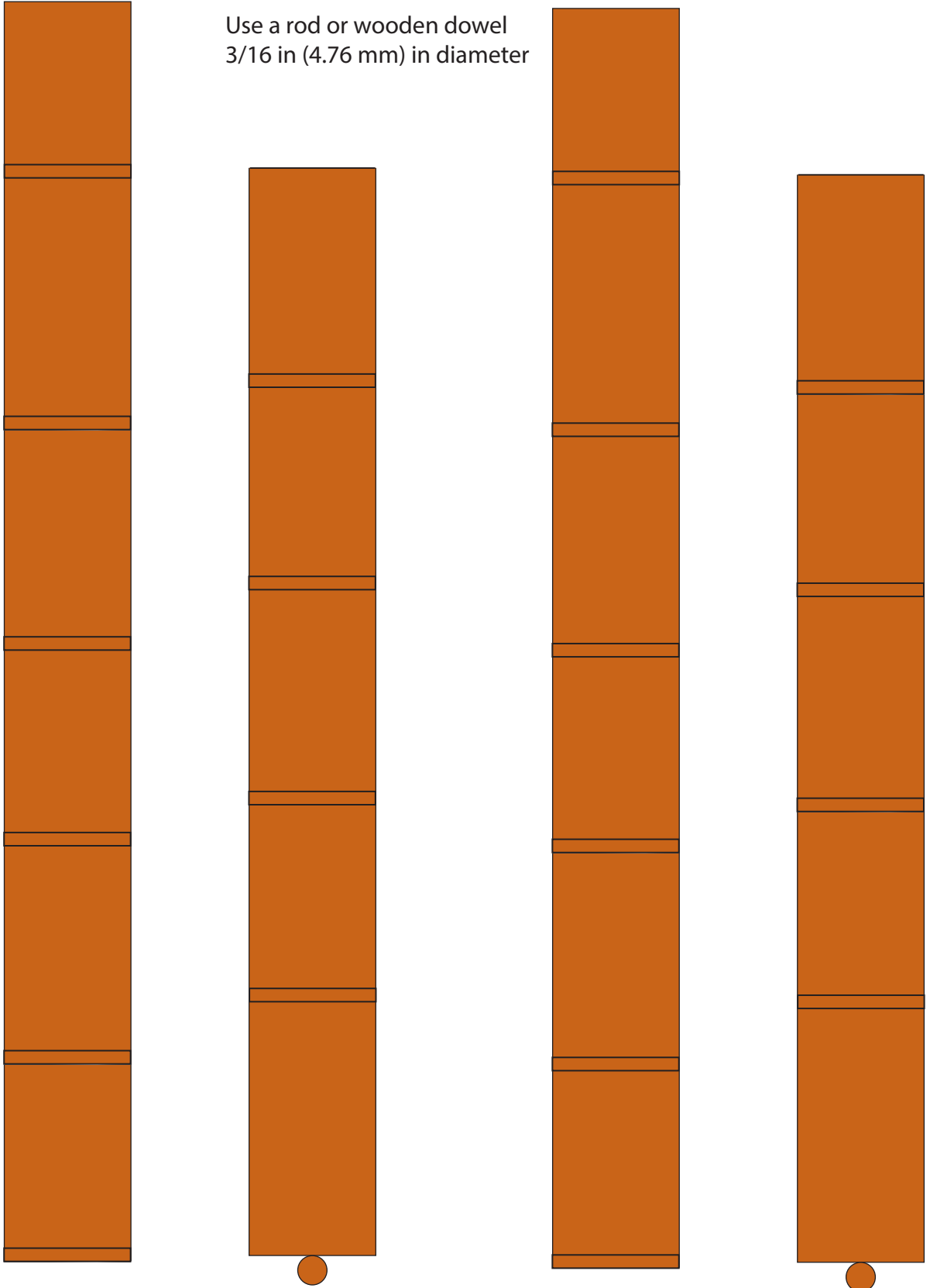



1 cm

1 inch

1:96 Scale

# Space Launch System (SLS)

Print on Cardstock (110 lbs)

## ARTEMIS

Revised

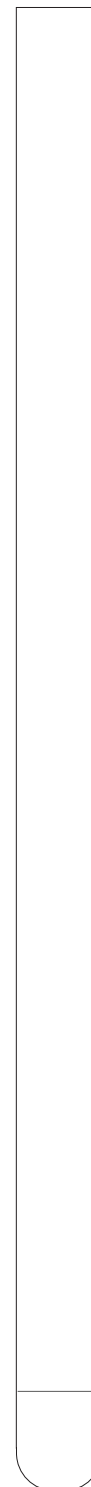
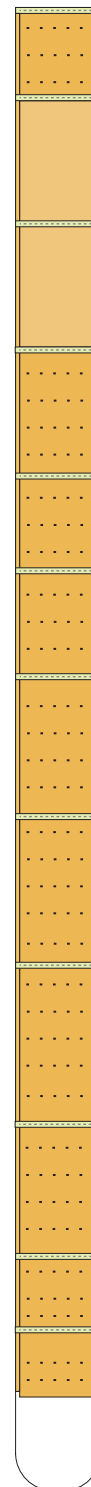
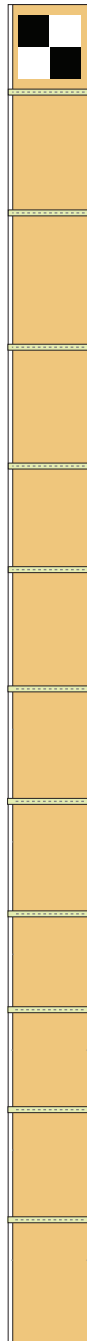
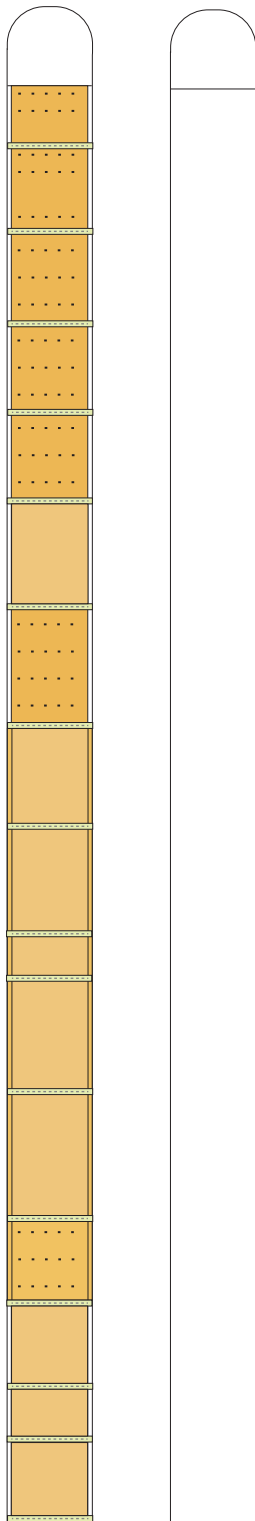
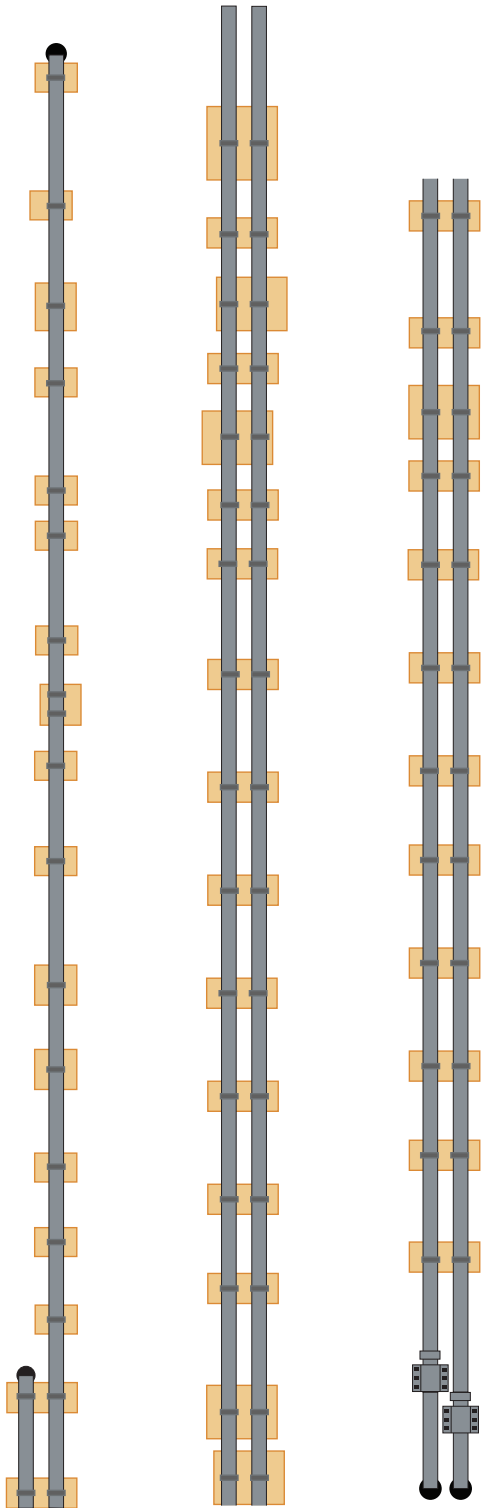
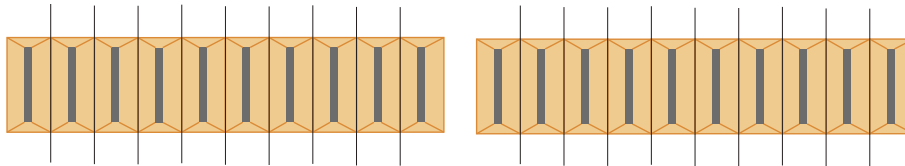
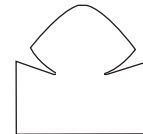
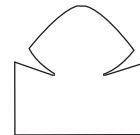



1:96 Scale

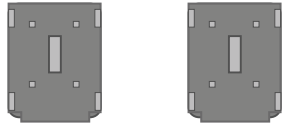

1 cm  
1 inch

# Space Launch System (SLS)

Print on Cardstock (110 lbs)

## ARTEMIS

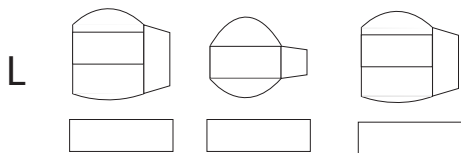
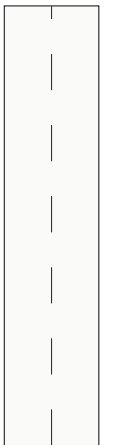
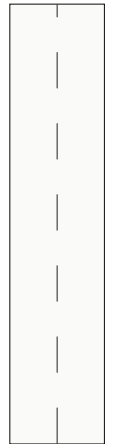
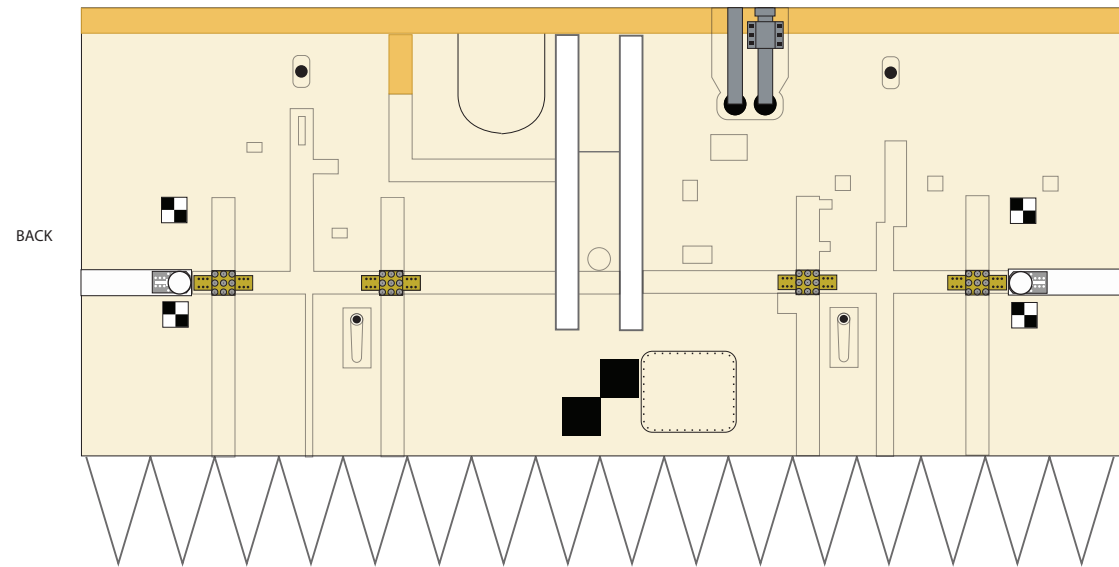
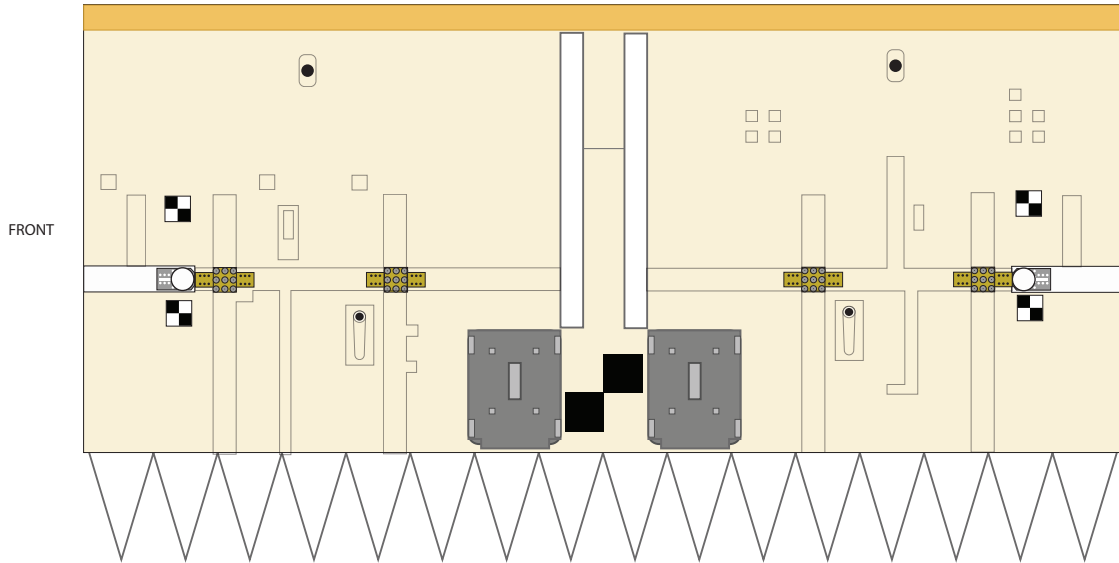
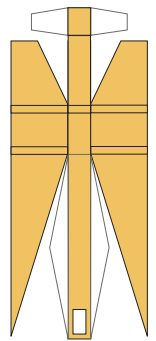
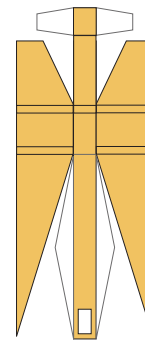
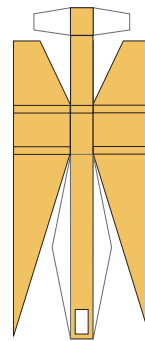
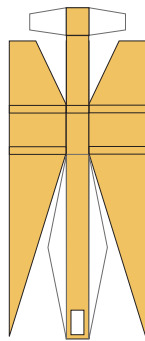

SRB/Core Stage struts

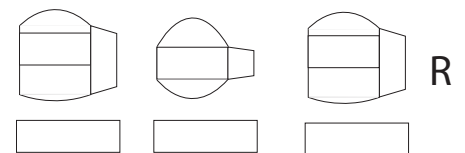

SRB/Core Stage struts



# Space Launch System (SLS)

Print on Cardstock (110 lbs)

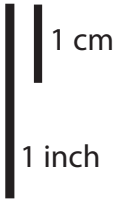

1:96 Scale

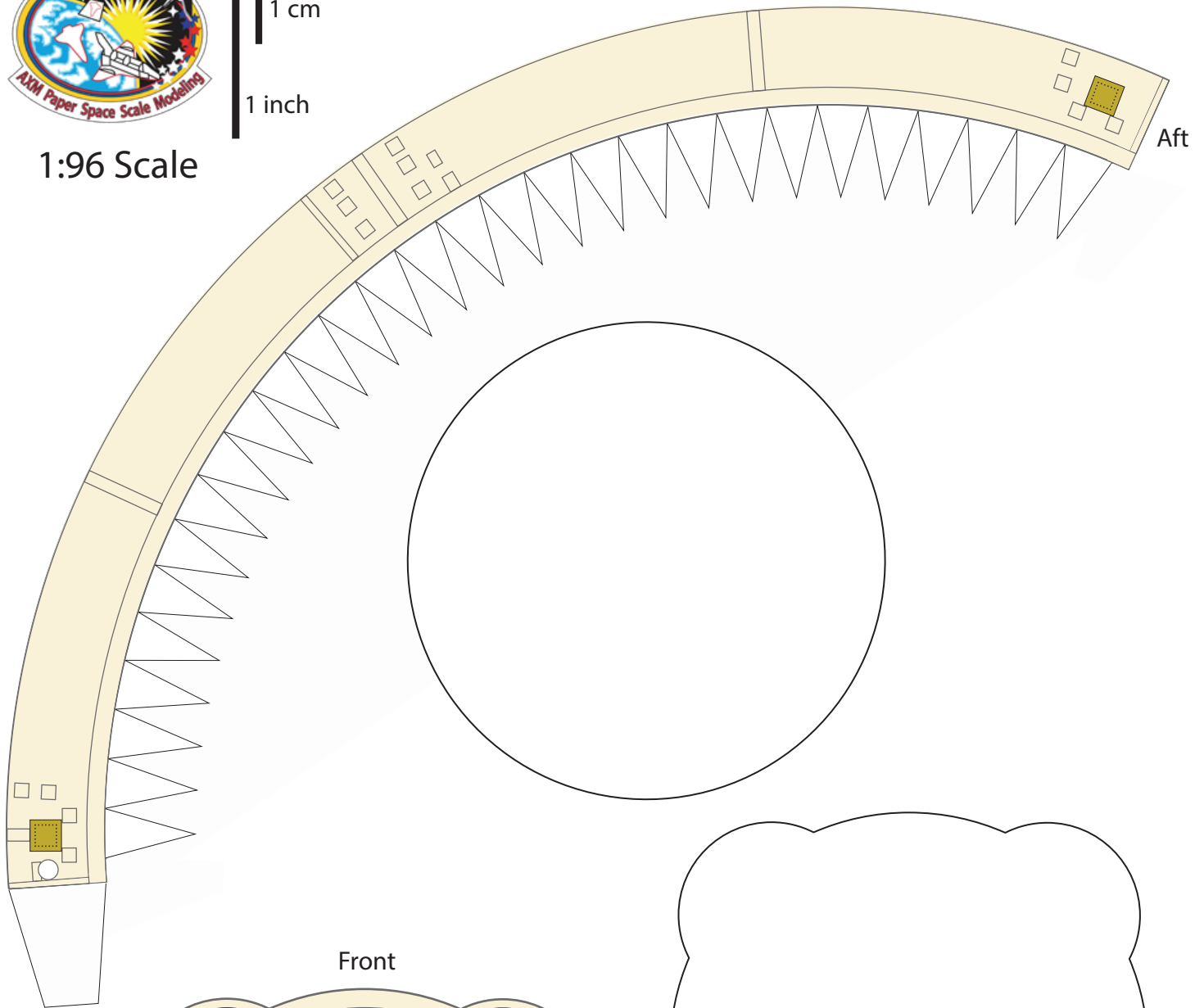

Front

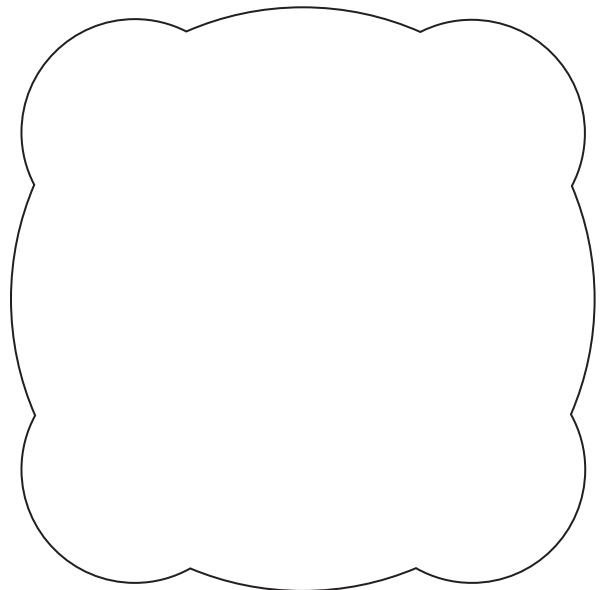
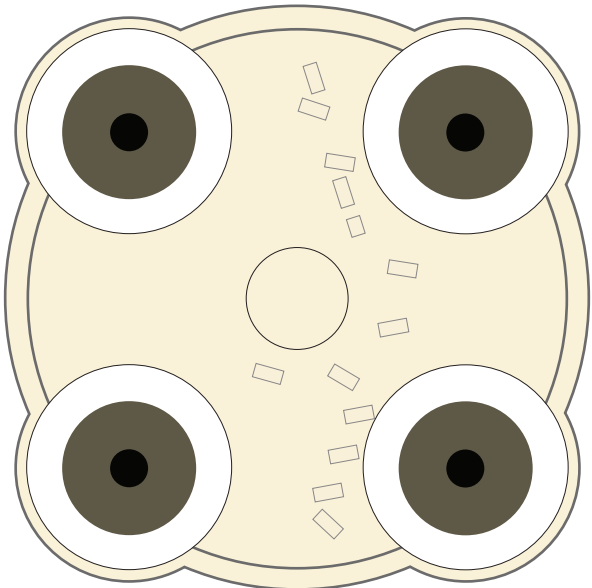

# ARTEMIS



1:96 Scale

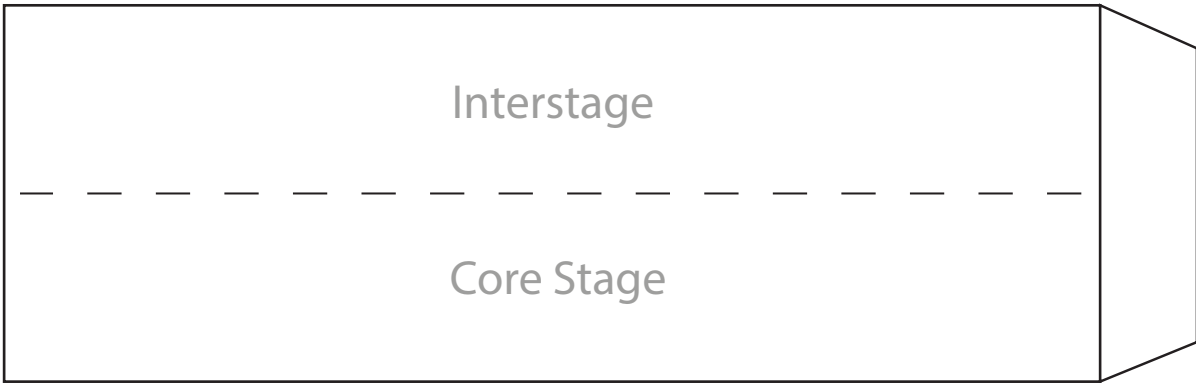

Print on Cardstock (110 lbs)

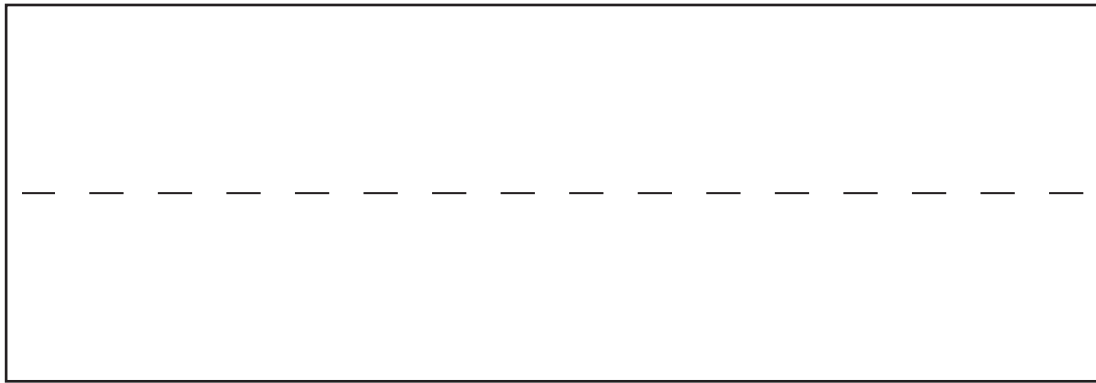

Space Launch System (SLS)

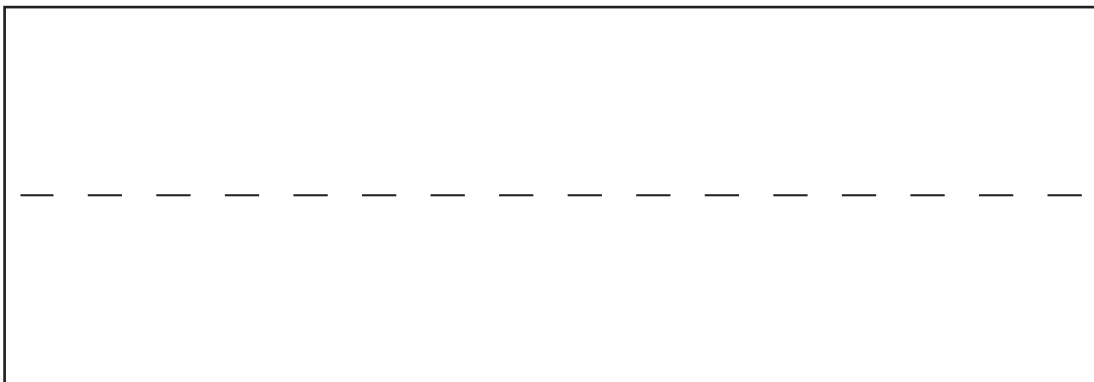
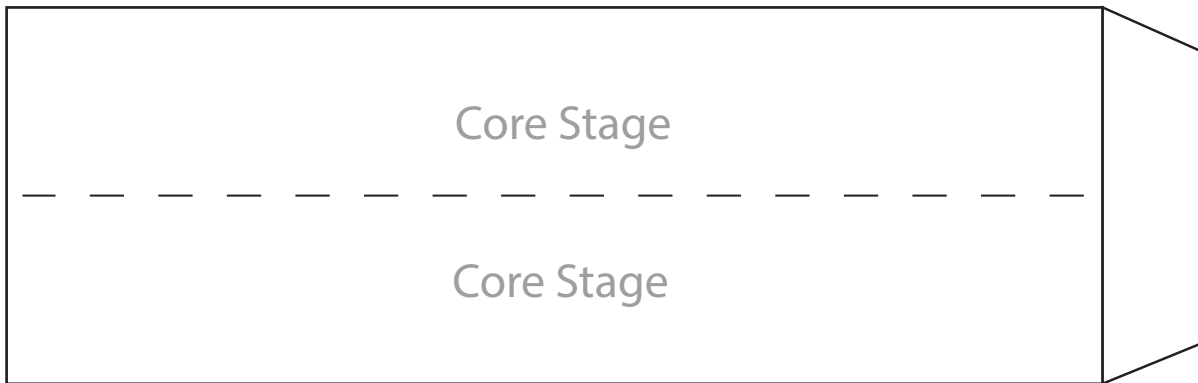





# Space Launch System (SLS)

Print on Cardstock (110 lbs)

## ARTEMIS

1:96 Scale

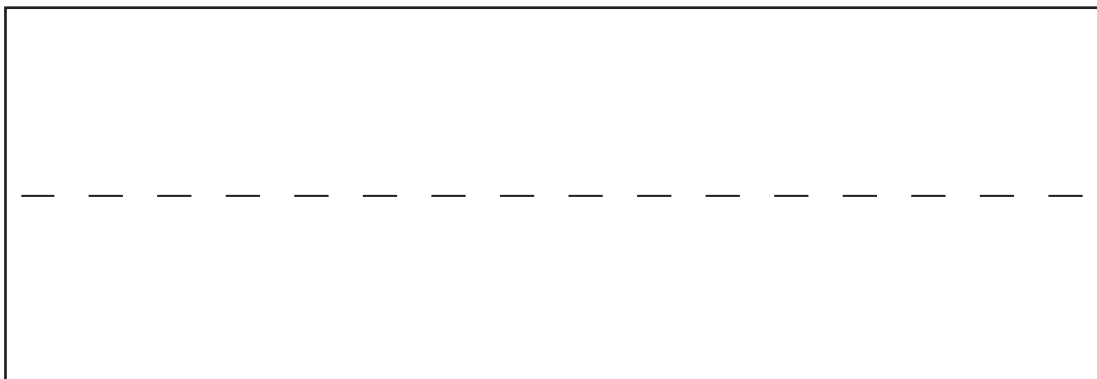
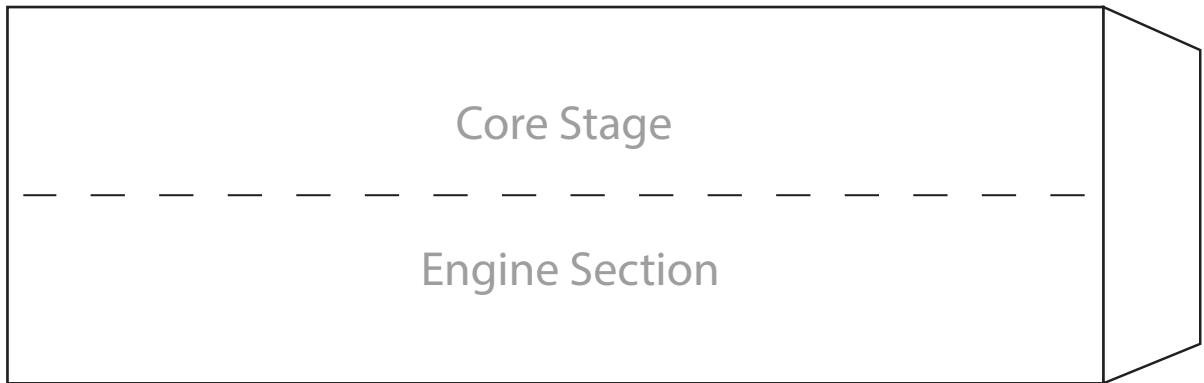
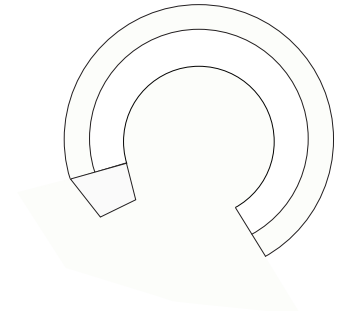
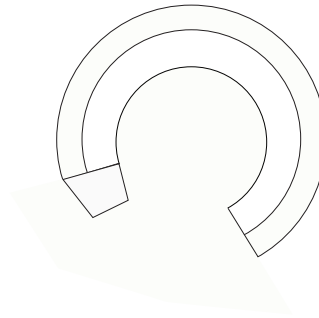
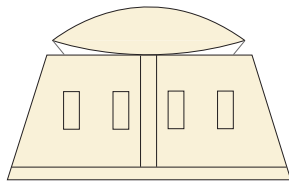
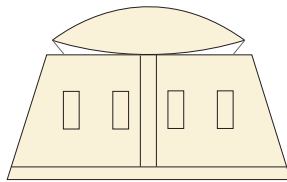
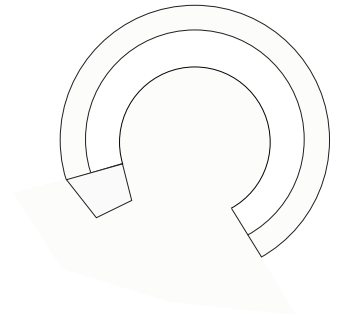
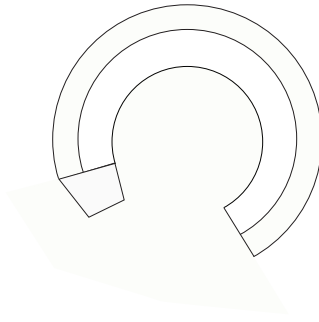
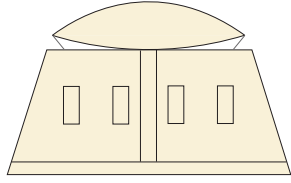
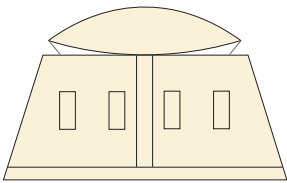

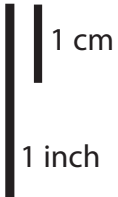

Space Launch System (SLS)

Print on Cardstock (110 lbs)

Core Stage Formers

PRINT X 4

1:96 Scale

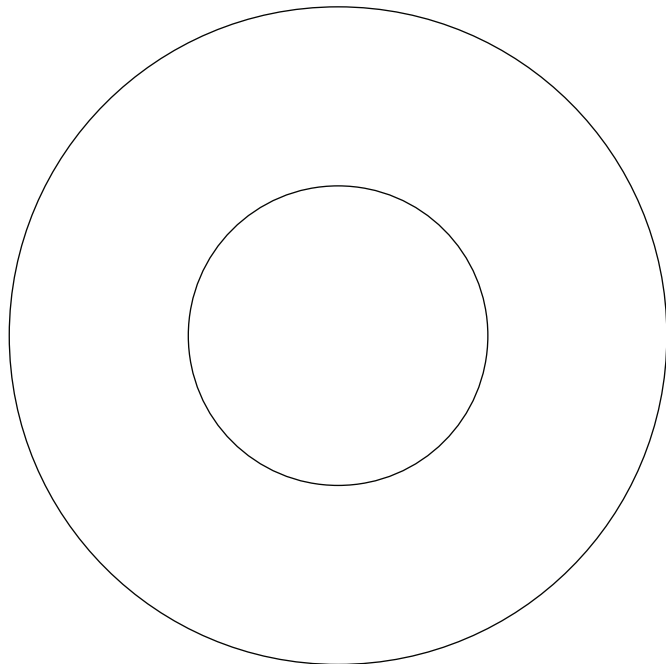
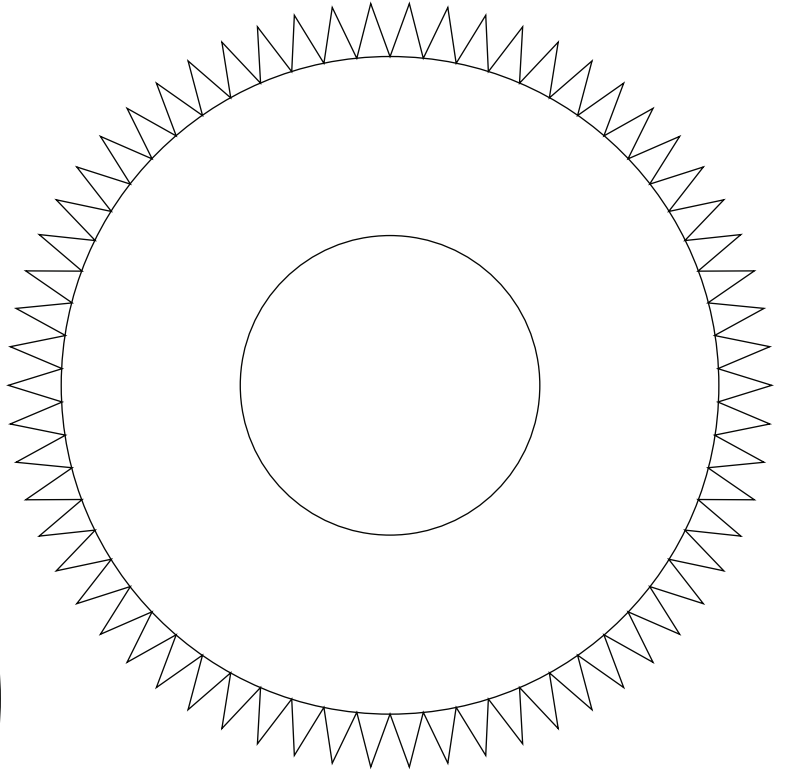
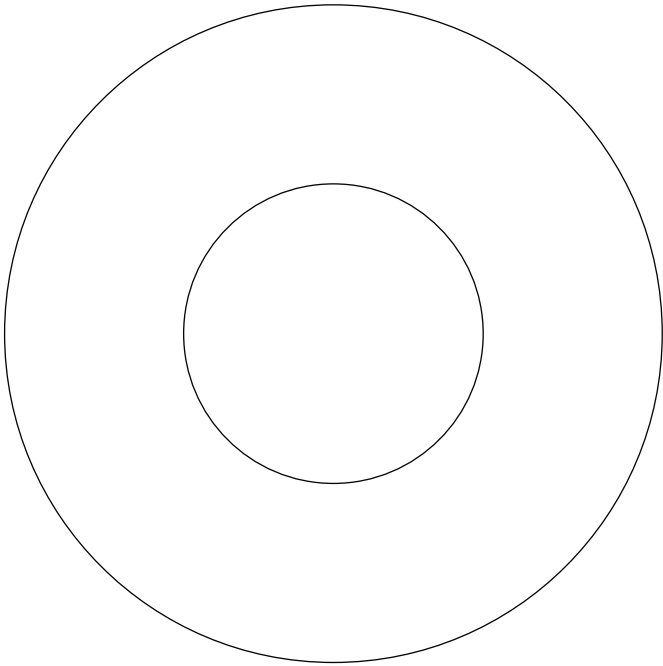



# Space Launch System (SLS)

Print on Cardstock (110 lbs)

## RS-25 Main Engines

1:96 Scale

