



LVM3 Chandrayaan3

Print on Cardstock (110 lb)

Chandrayaan 3

1:96 Scale

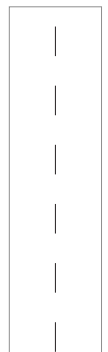
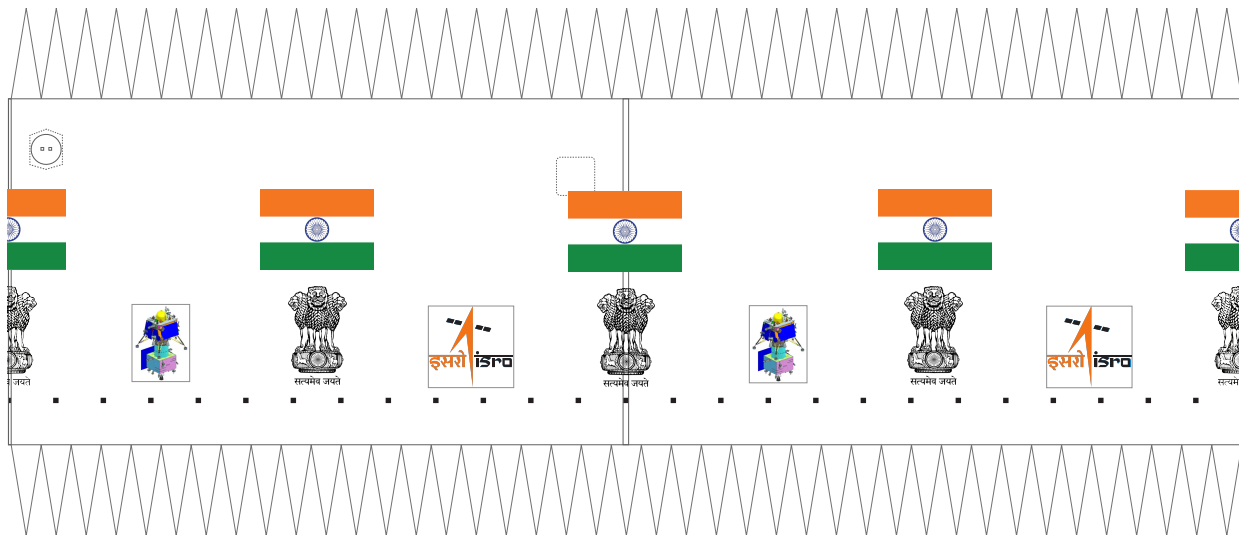
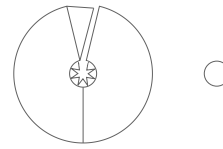
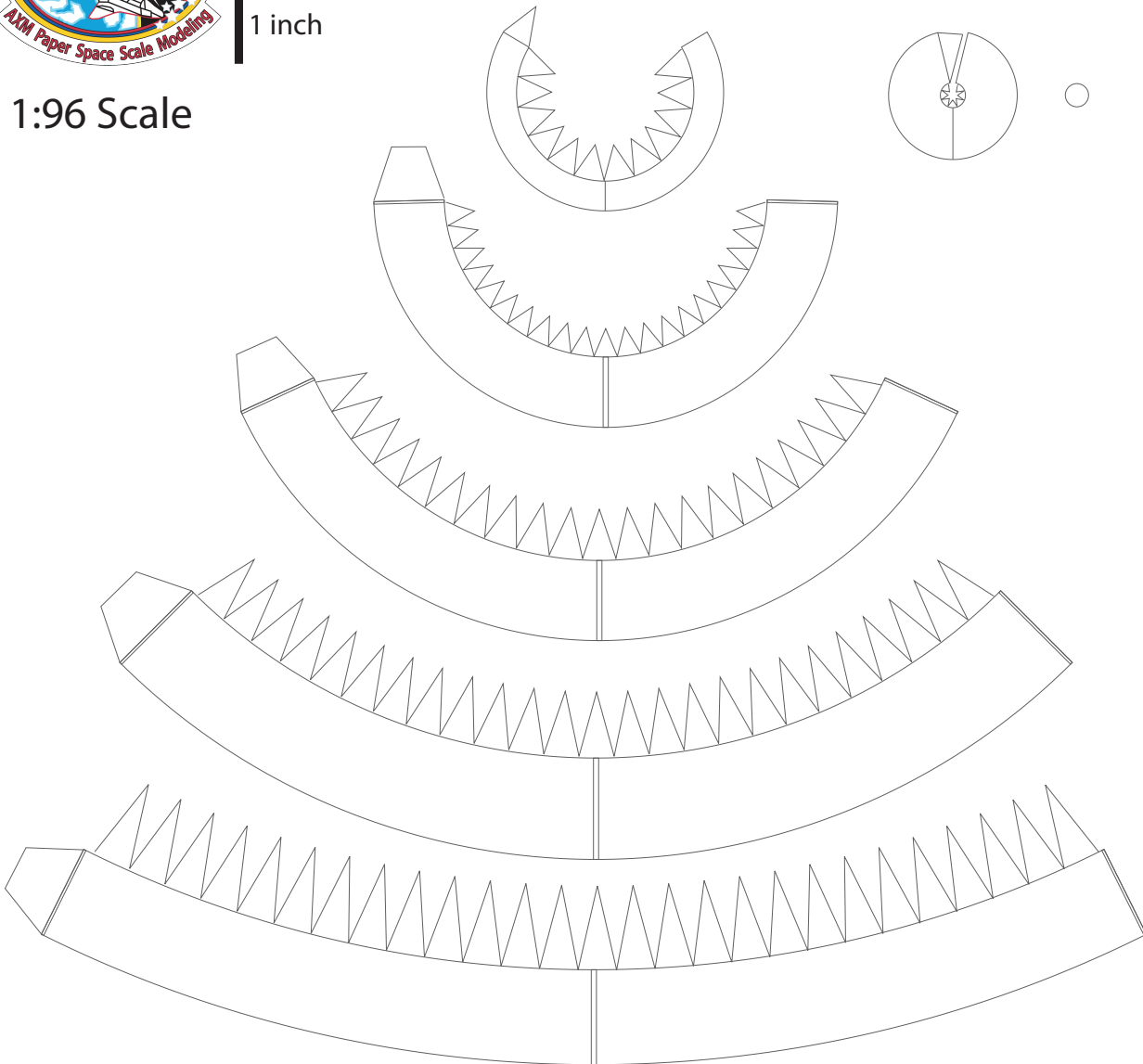



1 cm
1 inch

LVM3 M4

C 25 Cryogenic Upper Stage

Print on Cardstock (110 lb)

1:96 Scale

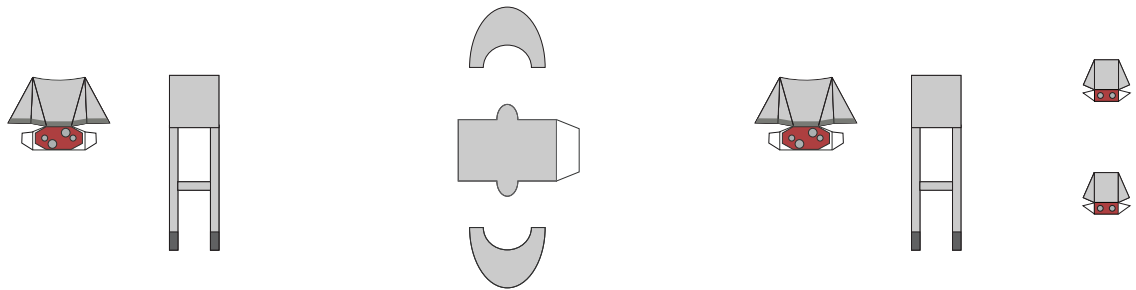
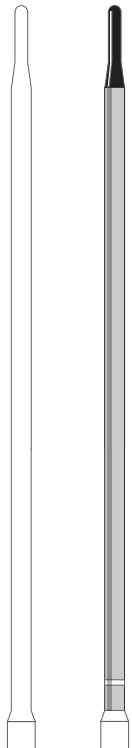
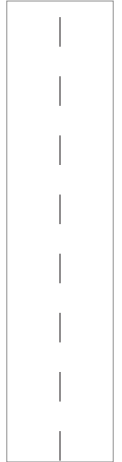
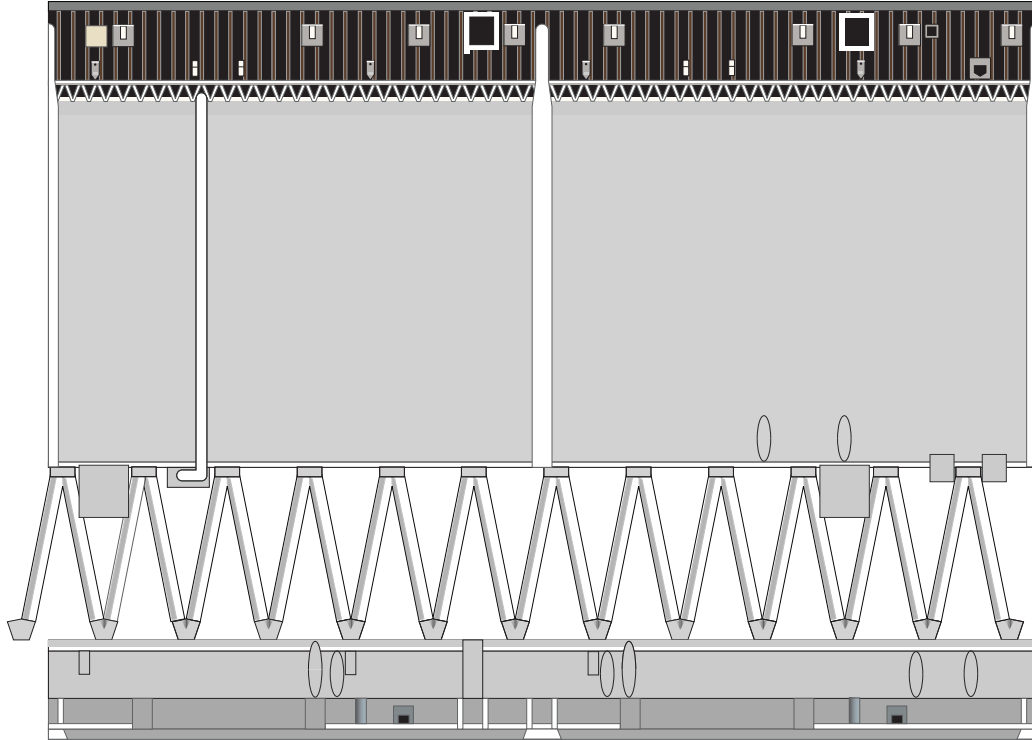
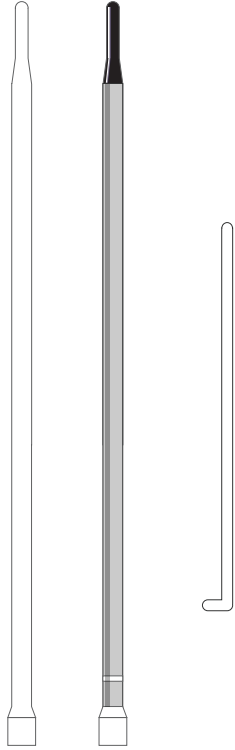



LVM3 M4

Print on Cardstock (110 lb)

Launch pad configuration (use protective covers)



1:96 Scale

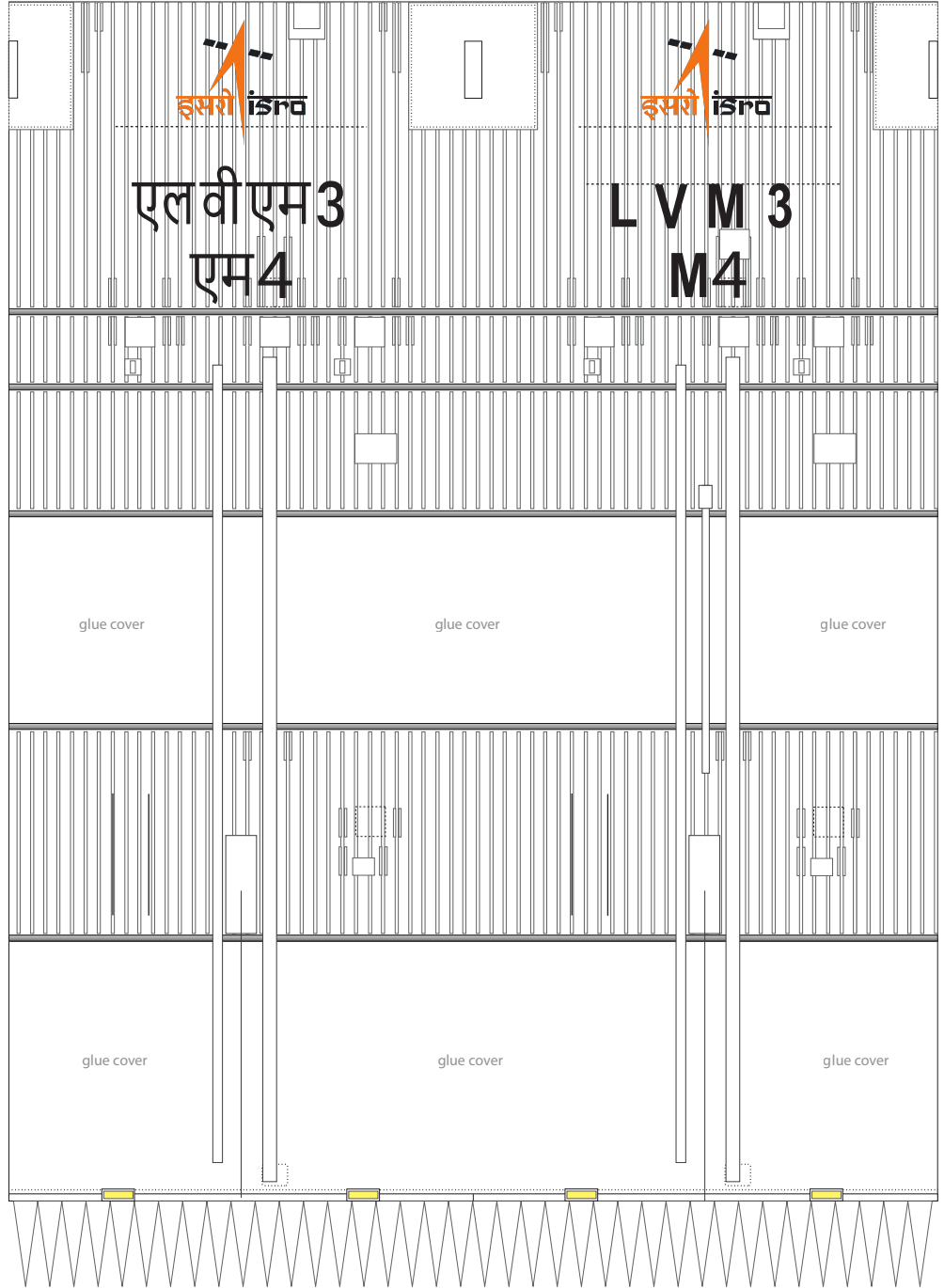
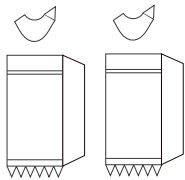
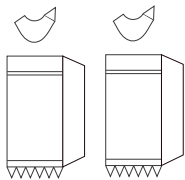
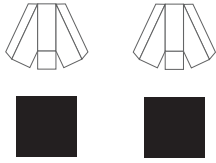
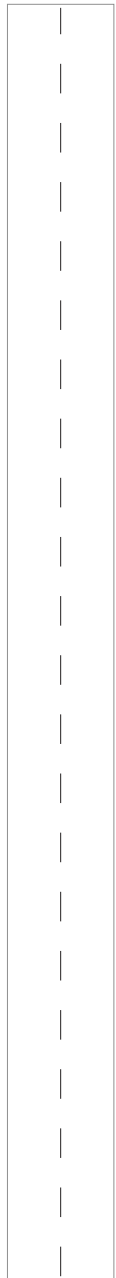

cut out yellow rectangles





Umbilicals and Covers

Print on Cardstock (110 lb)

LVM3

1:96 Scale

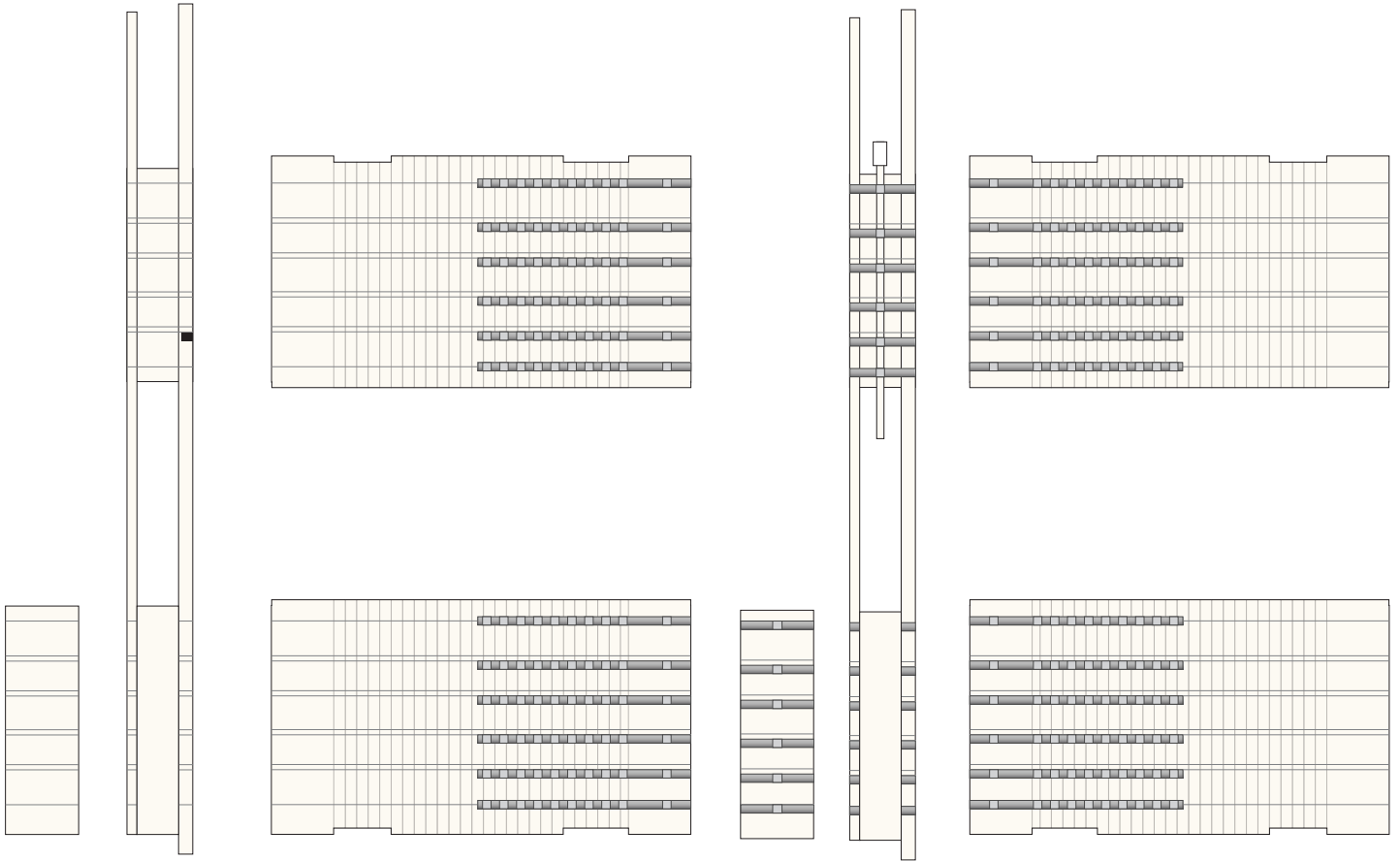



1:96 Scale

PRINT ON PLAIN PAPER

LVM3

Use cottonswabs 47 mm in length
with an aprox. 2.5 mm in width

(Use these skins to cover the swabs)

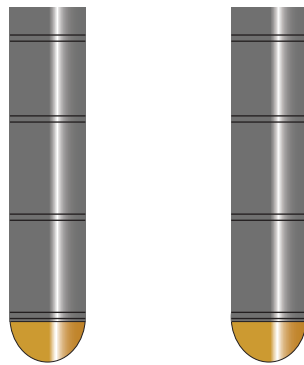



1 cm

1 inch

Engine section

Print on Cardstock (110 lb)

1:96 Scale

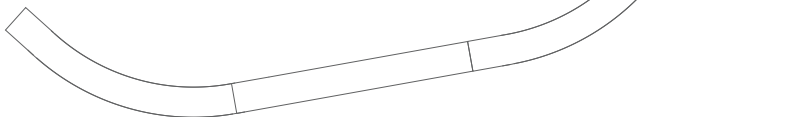
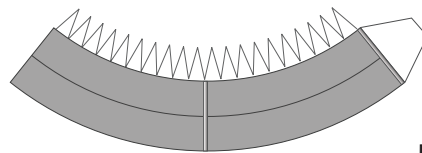
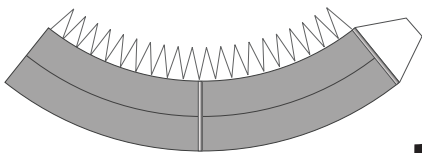
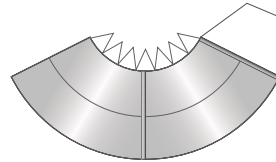
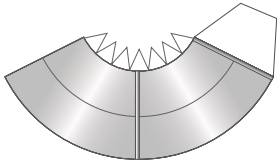
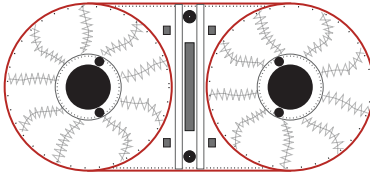
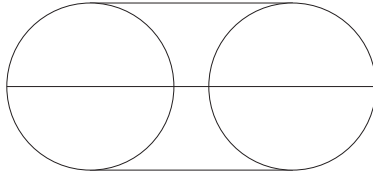
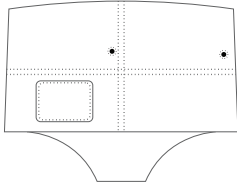
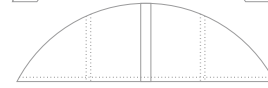
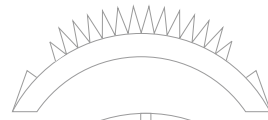
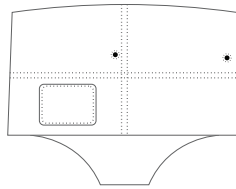
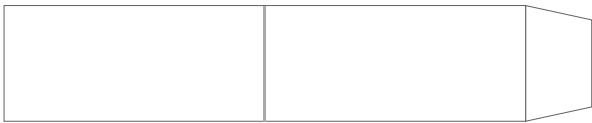
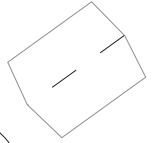
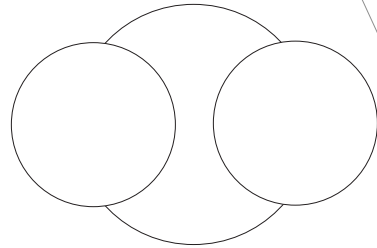
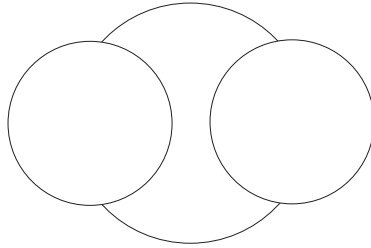
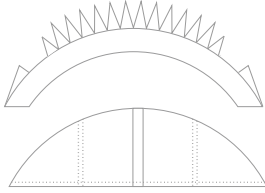
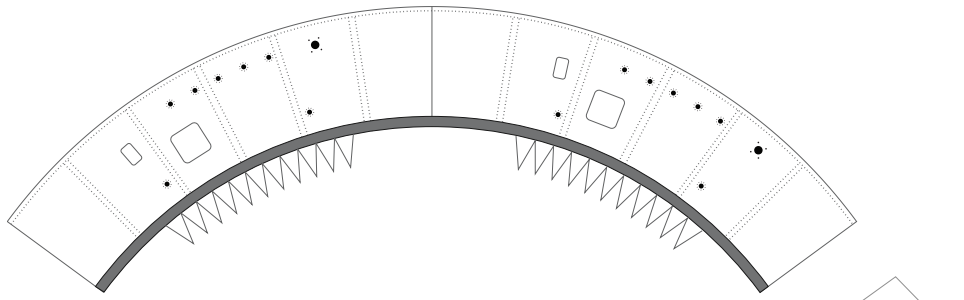



LVM3 M4

Print on Cardstock (110 lb)

1:96 Scale

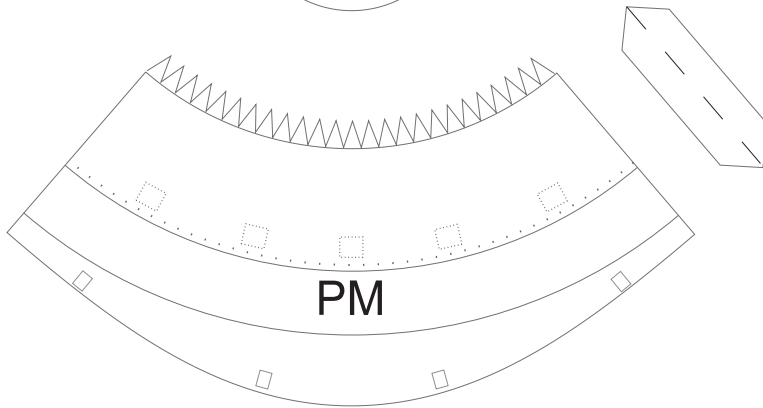
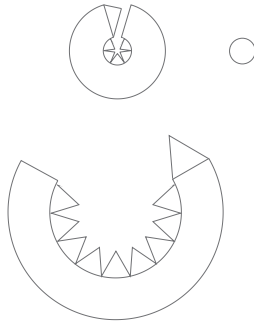
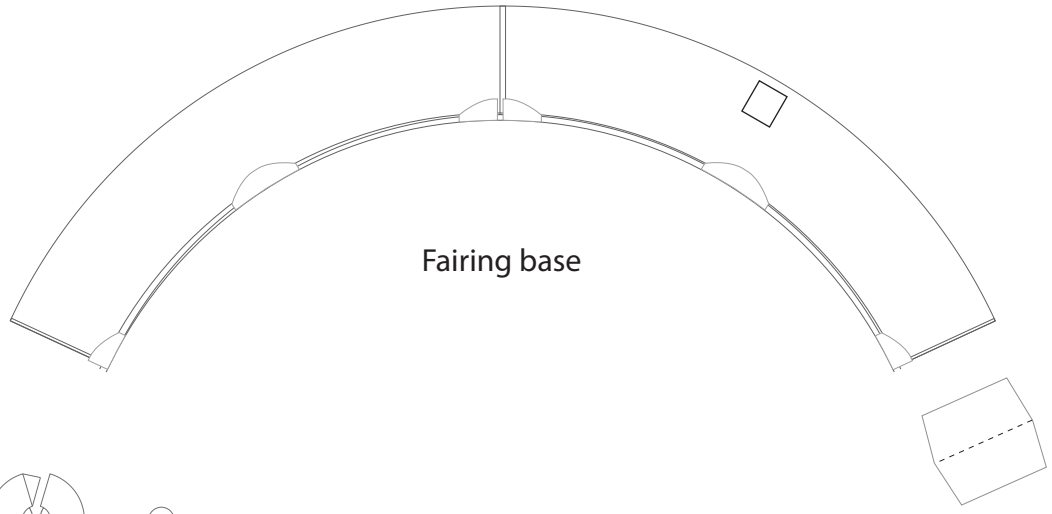

Left

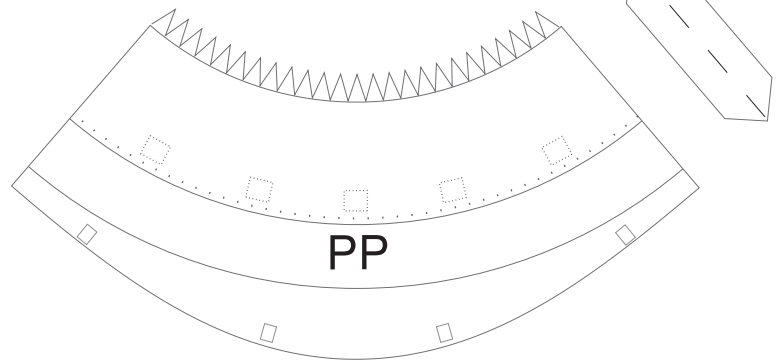
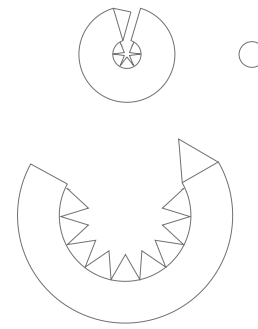

Right



1 cm
1 inch

1:96 Scale



LVM3 M4

Left SRB

Print on Cardstock (110 lb)

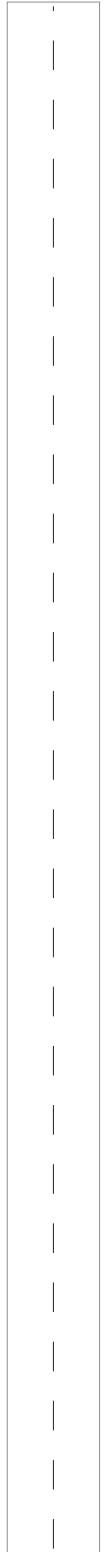

cut out yellow rectangles

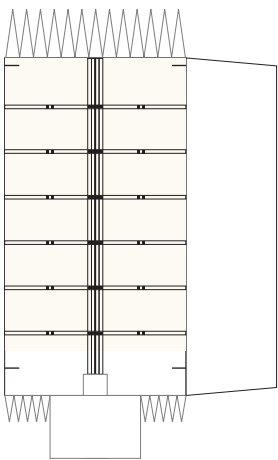
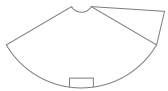



1 cm
1 inch

LVM3 M4

Right SRB

Print on Cardstock (110 lb)

1:96 Scale

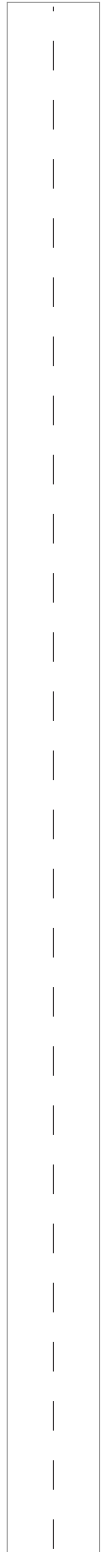
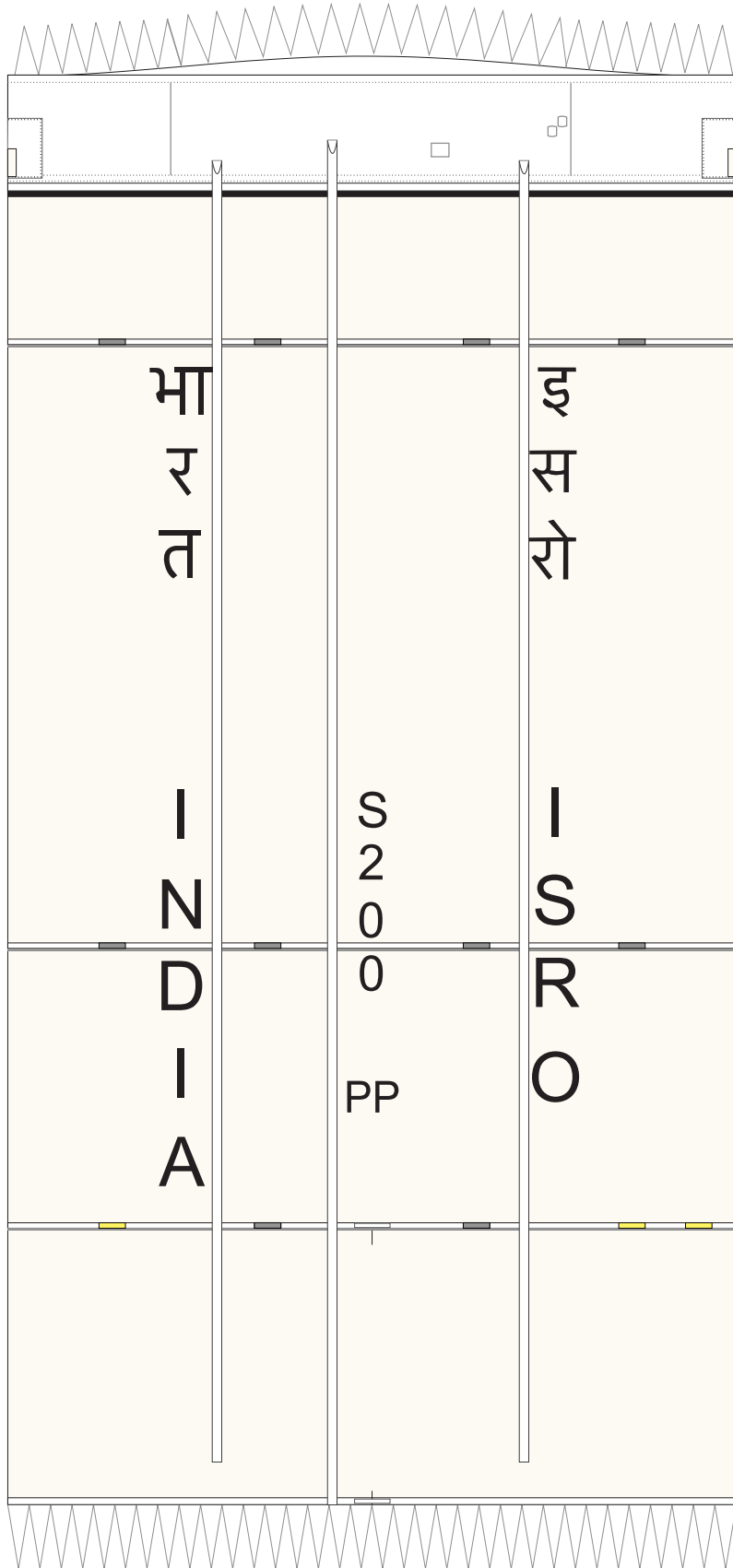
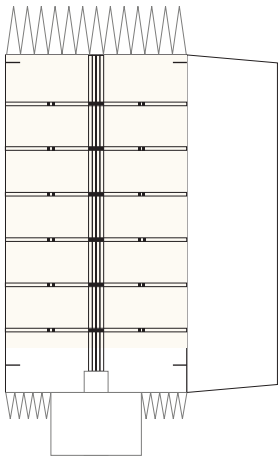
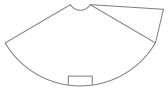

cut out yellow rectangles



Booster attachments

Print on Cardstock (110 lb)

1:96 Scale

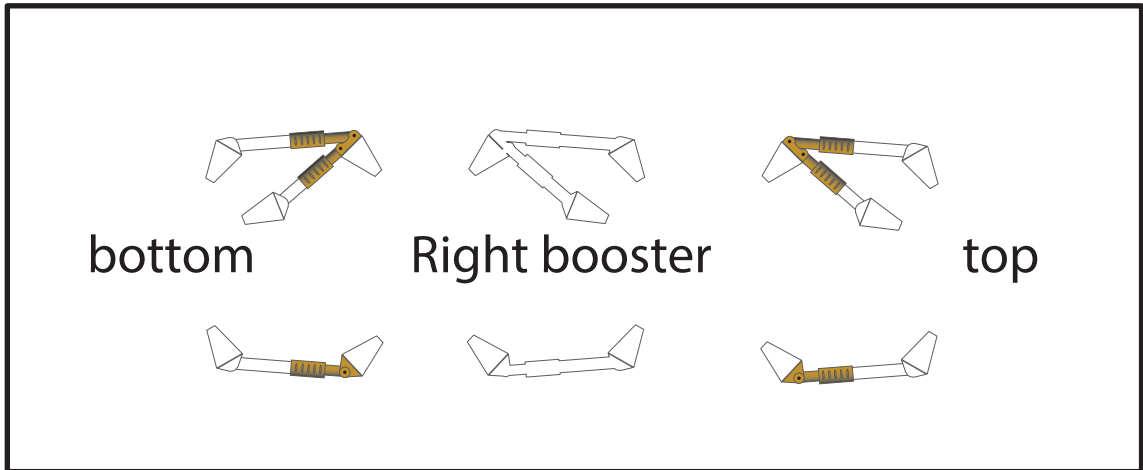
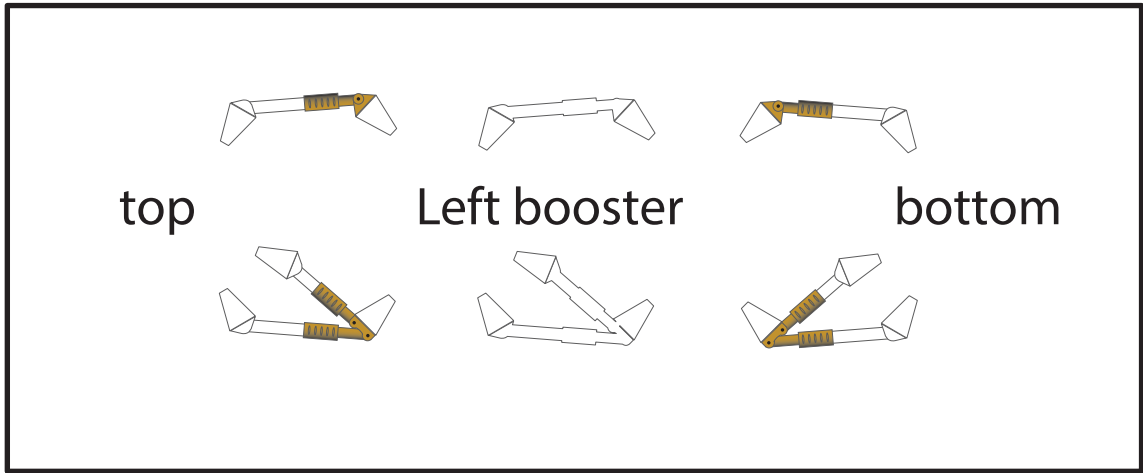
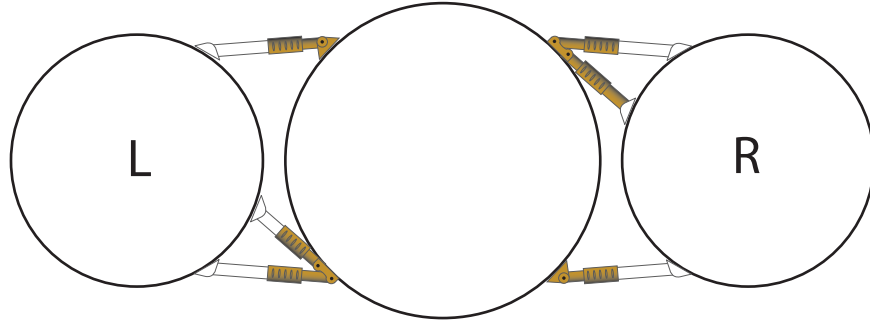



1 cm

1 inch

LVM3

Print on Cardstock (110 lb)

1:96 Scale

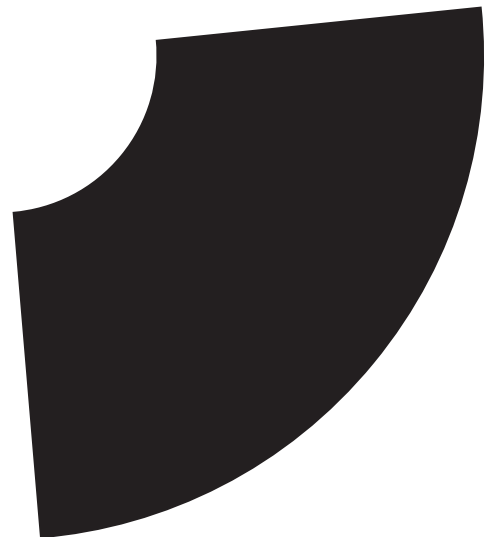
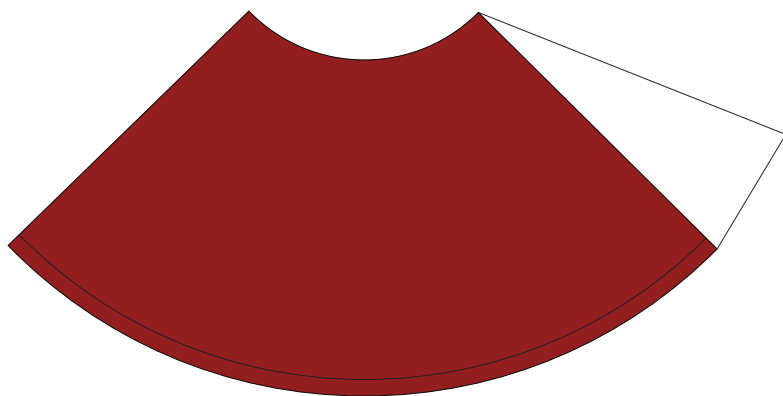
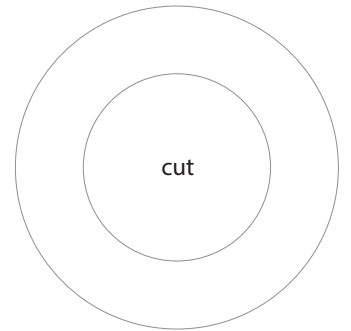
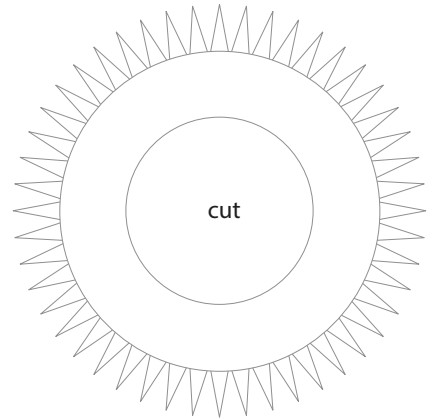
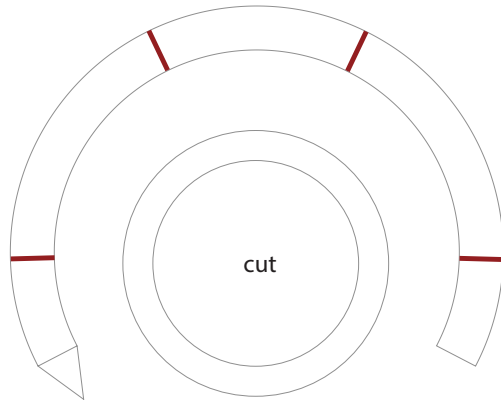
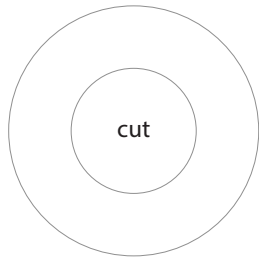
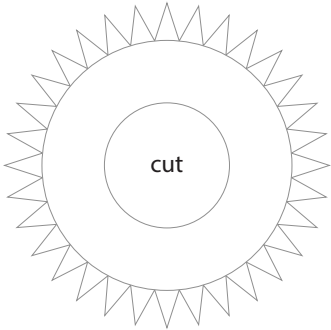
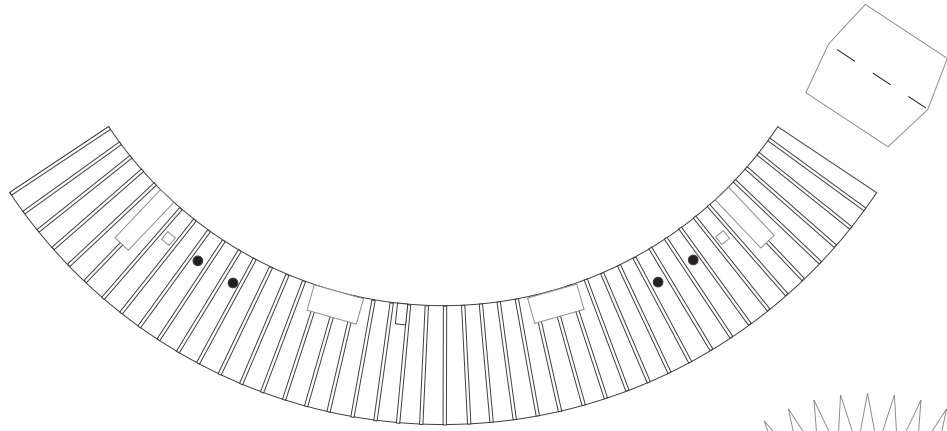



1 cm
1 inch

LVM3

Print on Cardstock (110 lb)

1:96 Scale

