



1:100 Scale



SpaceX Starship Nosecone diagram

Print on Cardstock (110 lbs)

Nosecone interior parts in red.

LOX header tank

Header Tank pipe

1

2

3

12 COPV area

Bottom ring

4 Stack Segment

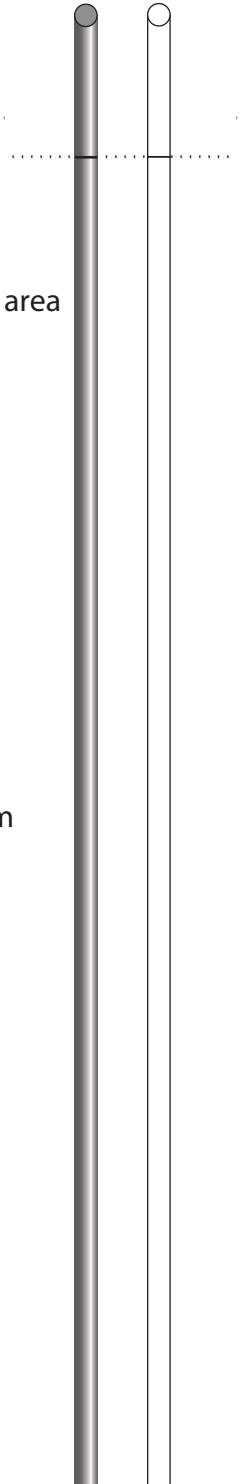
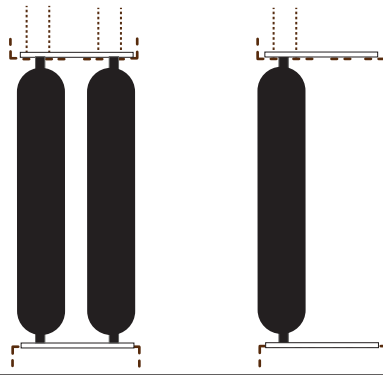



1:100 Scale



SpaceX Starship Nosecone interior

Print on Cardstock (110 lbs)

1

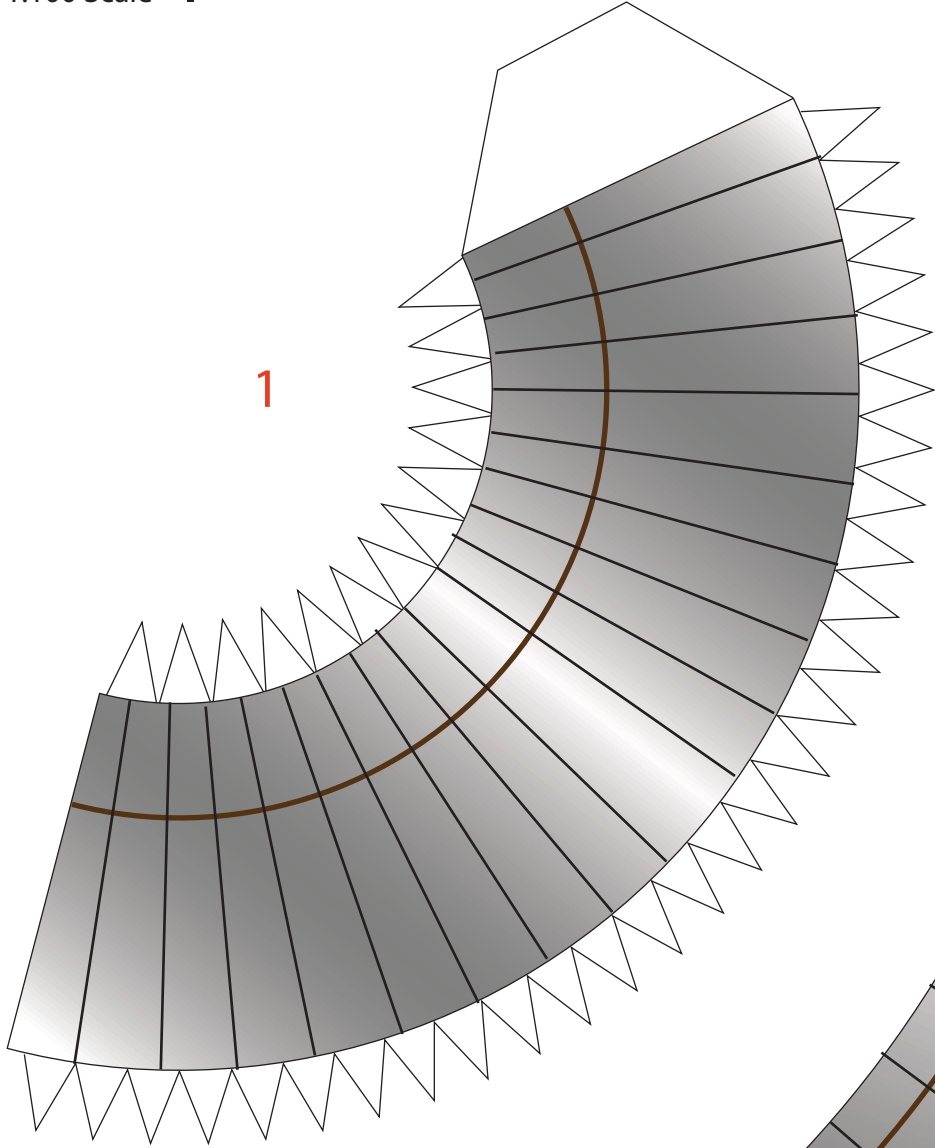

2

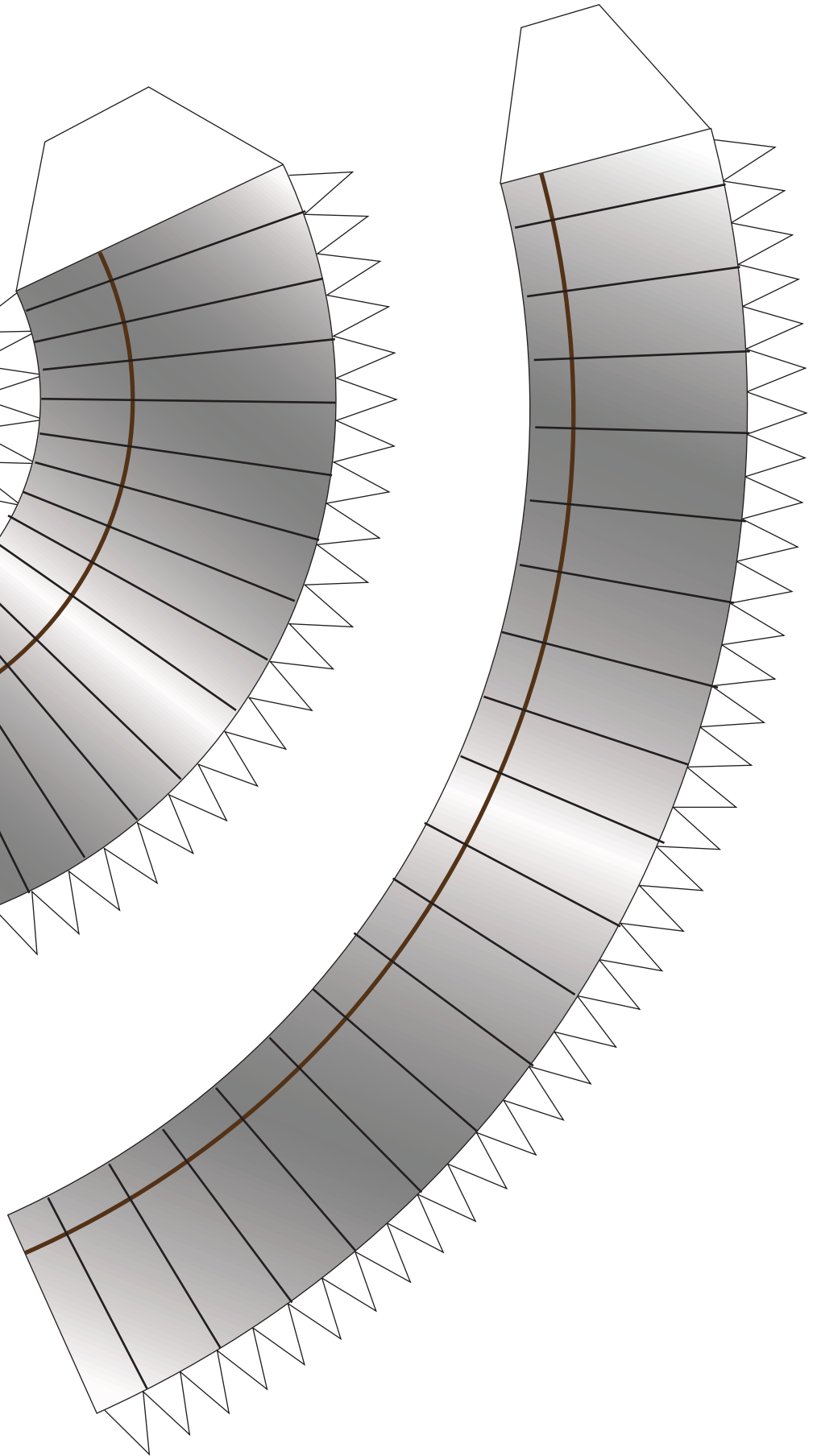



1:100 Scale



SpaceX Starship Nosecone interior

Print on Cardstock (110 lbs)

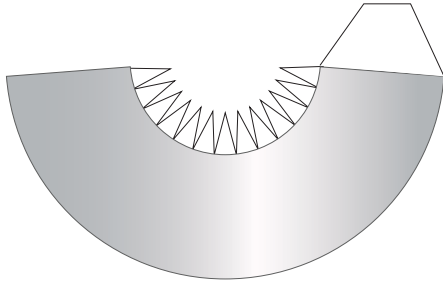
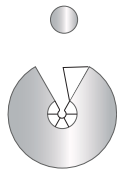

LOX
header tank

Black dots
point upwards

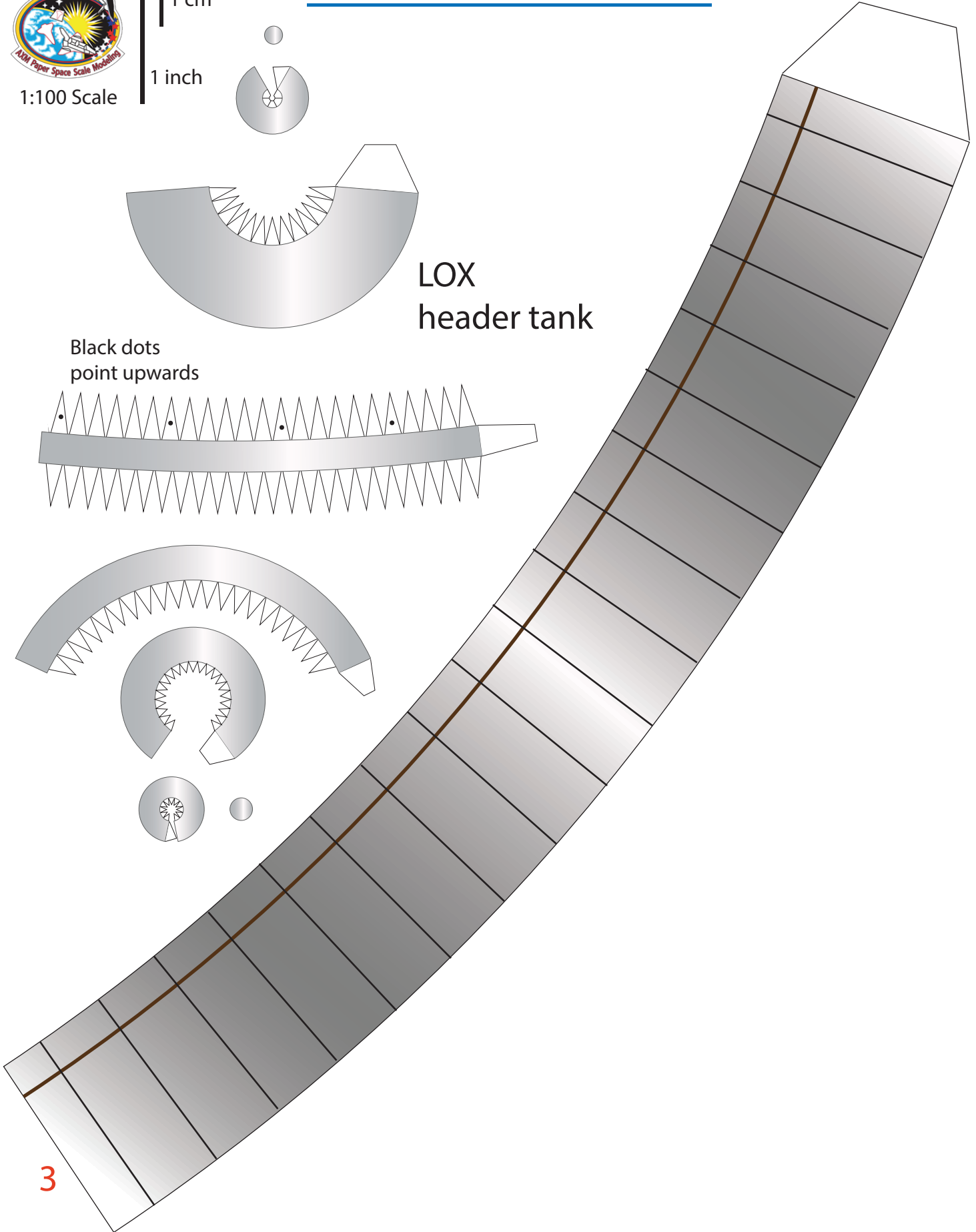
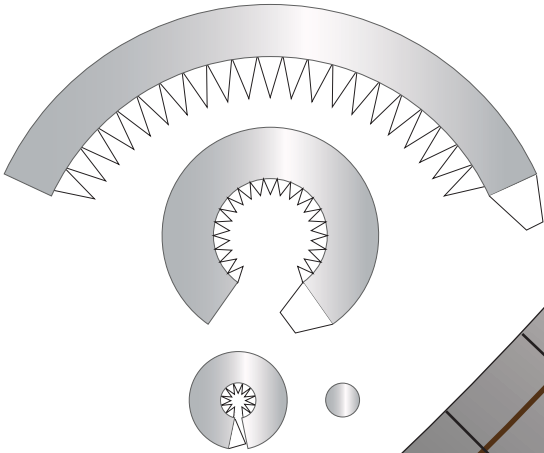
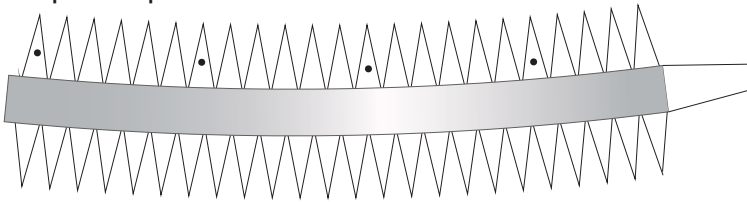

3



1:100 Scale



SpaceX Starship Header tanks support

Print on Cardstock (110 lbs)

Use for Ships 8, 9, 10, 11, 15, 20

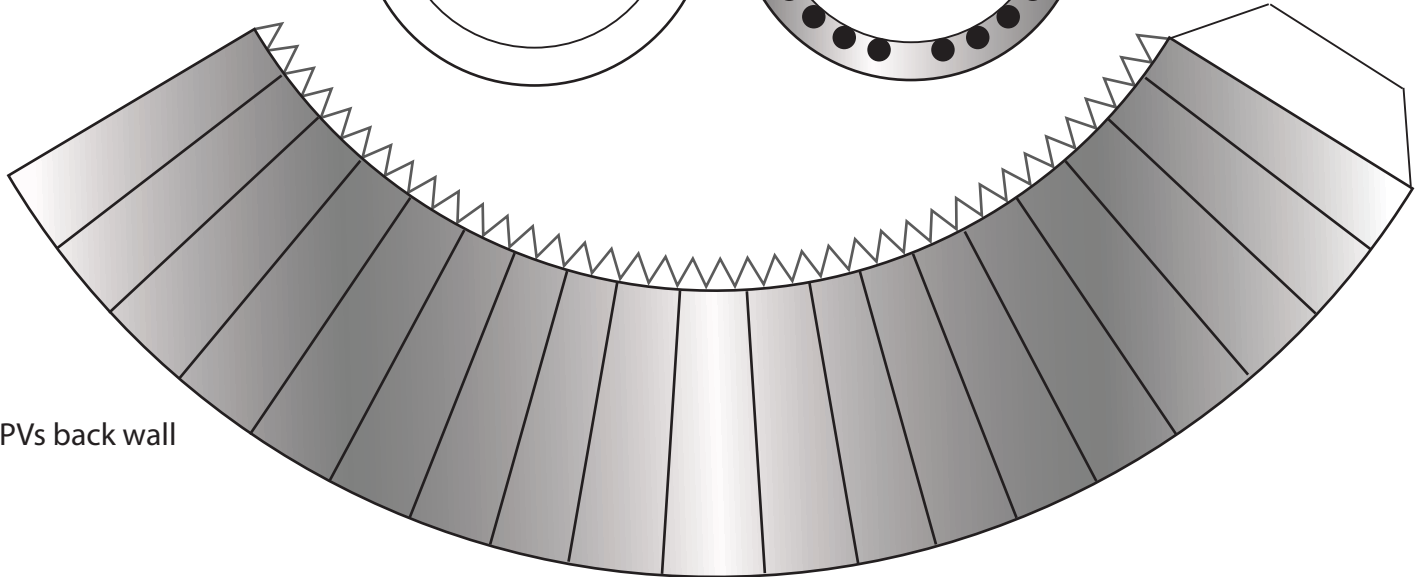
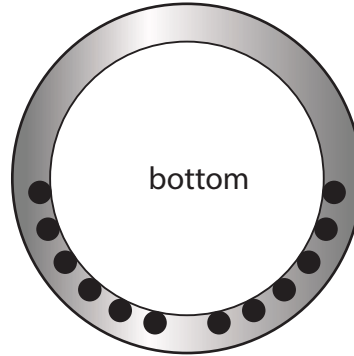
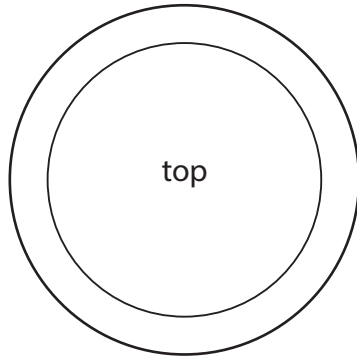
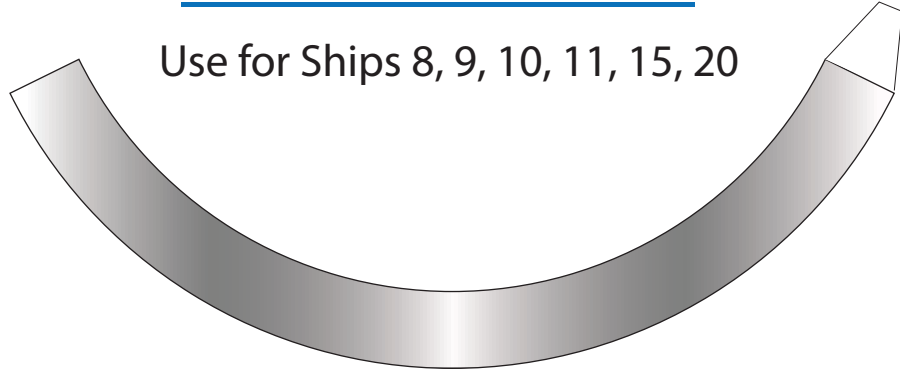

COPVs back wall

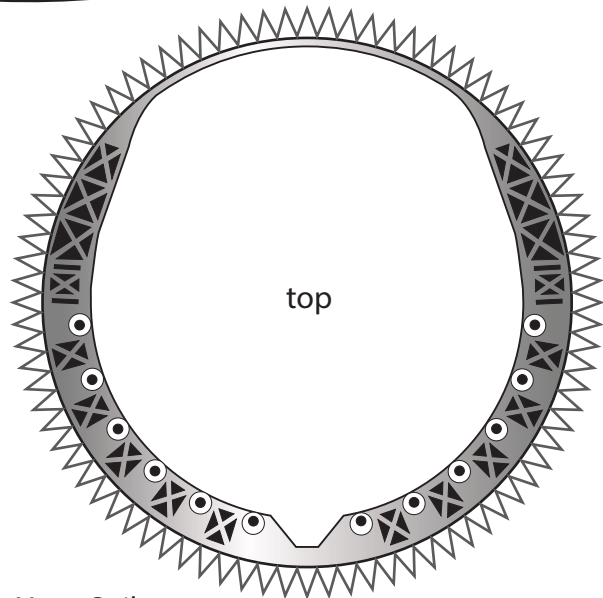
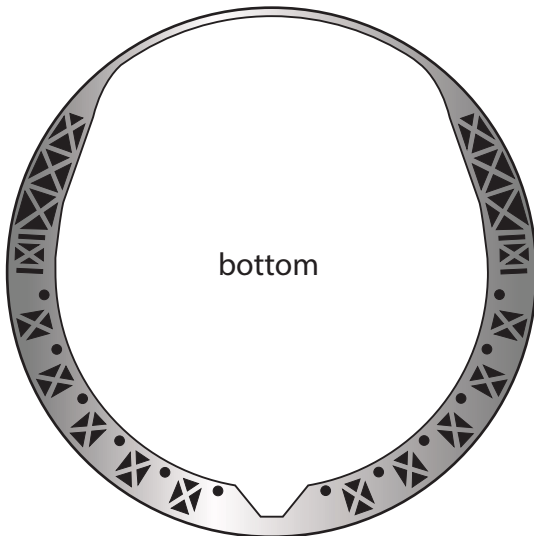



1:100 Scale



SpaceX Starship Nosecone interior

Print on Cardstock (110 lbs)

COPVs

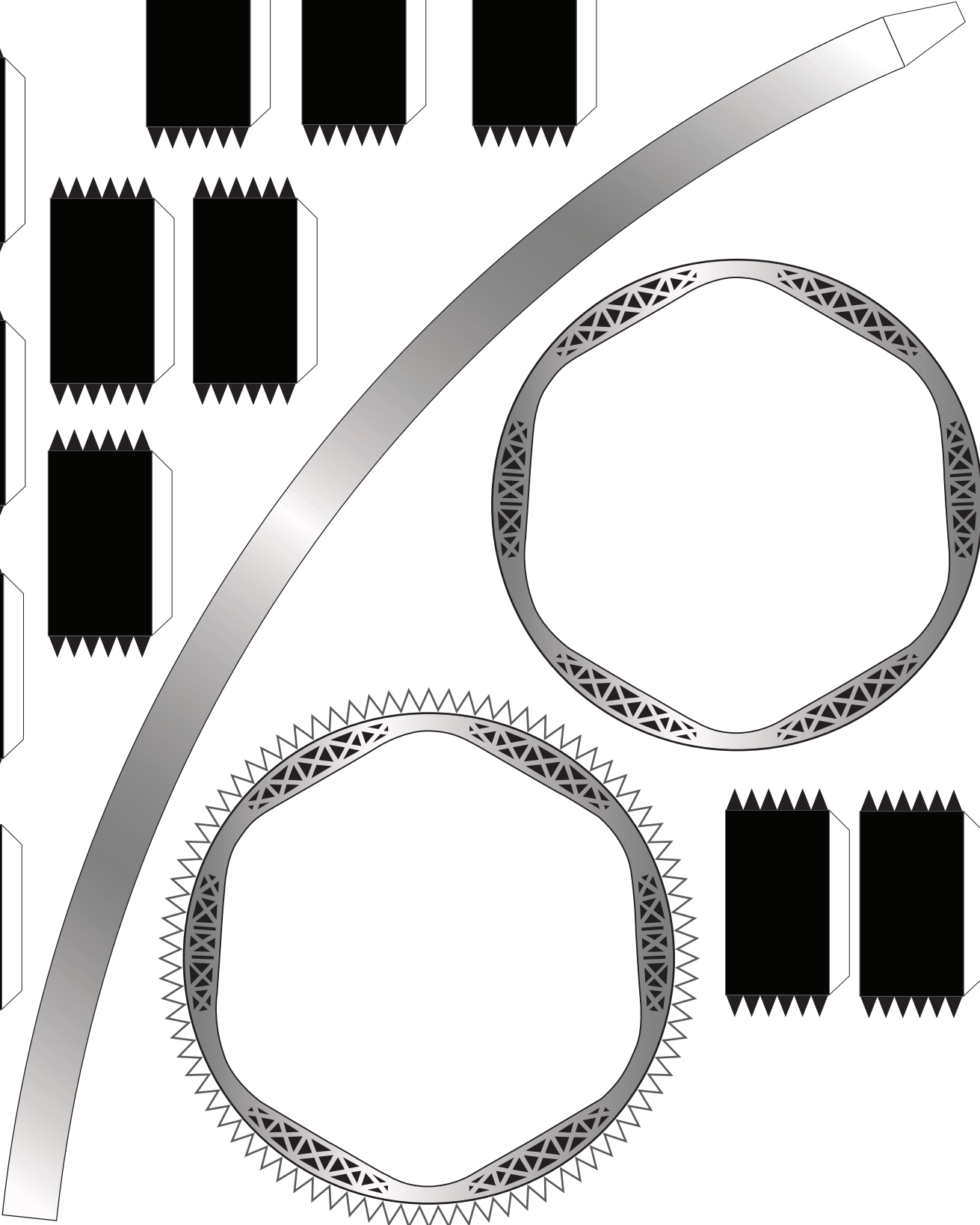
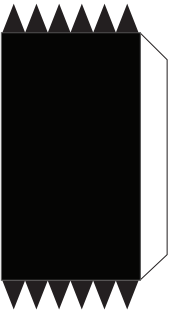
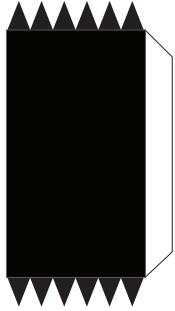
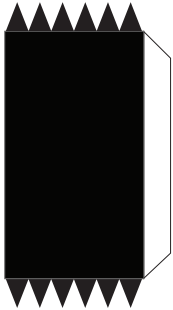
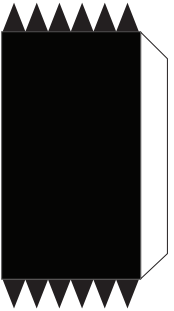
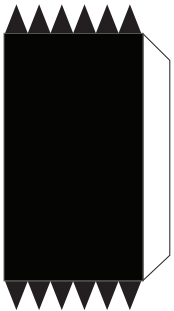
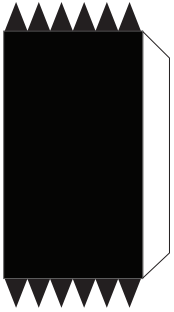



1 cm

SpaceX Starship

Print on Cardstock (110 lbs)

1 inch

Nosecone-body 4 ring stack interior detail

1:100 Scale

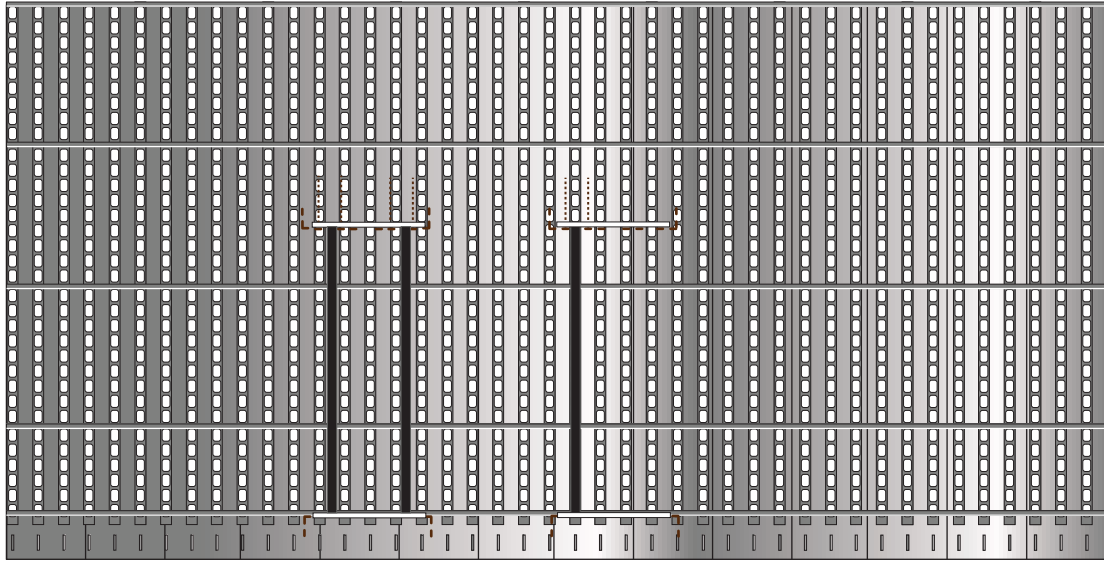
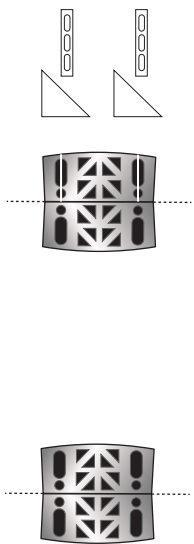

The nosecone interior detail with COPV's was obtained from photos of the Starship 3D model from @DStarship3 designer Yoan Soilen, who gave permission to be included on the AXM Starship design.

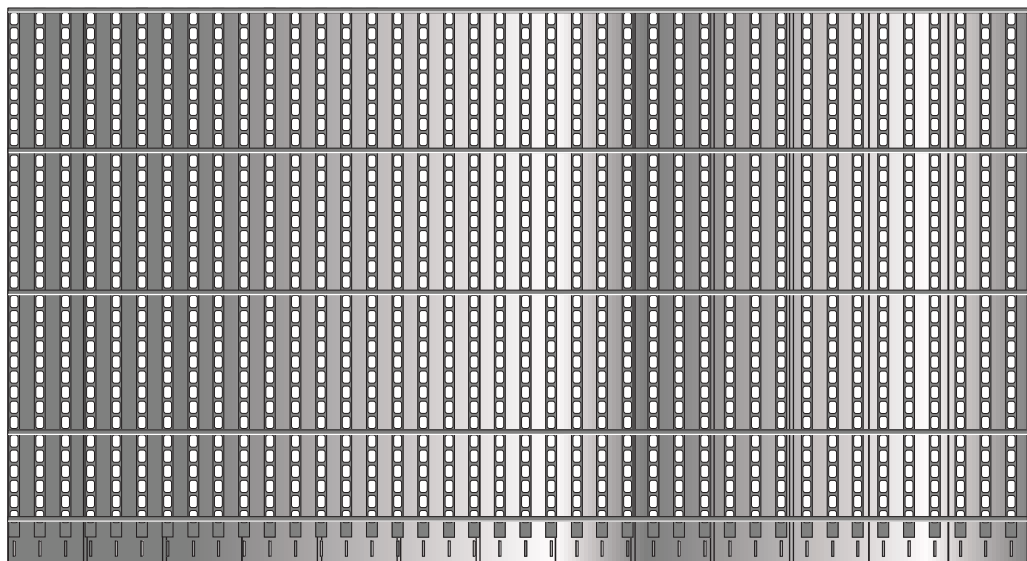
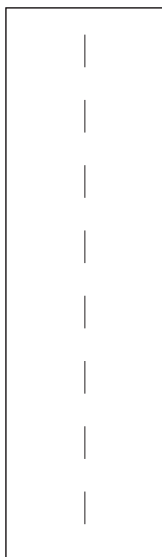
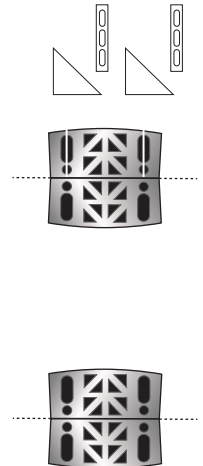
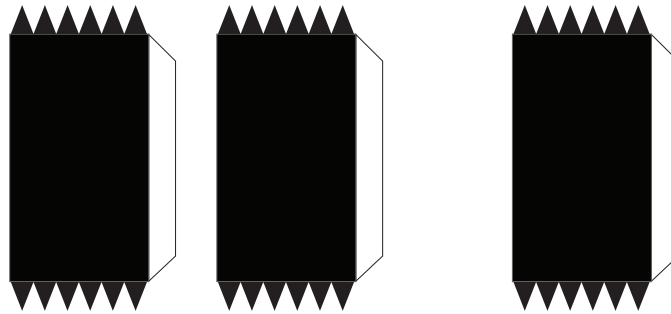



1 cm

1 inch

1:100 Scale

SpaceX Starship

Print on Cardstock (110 lbs)

To be glued on Starship's 4 or 5 ring segment section bottom edge

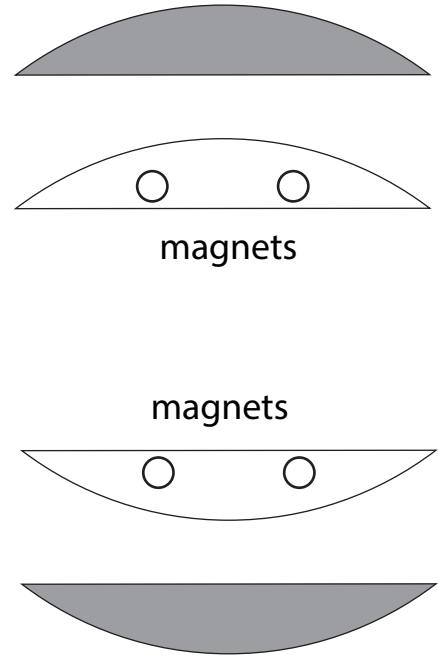
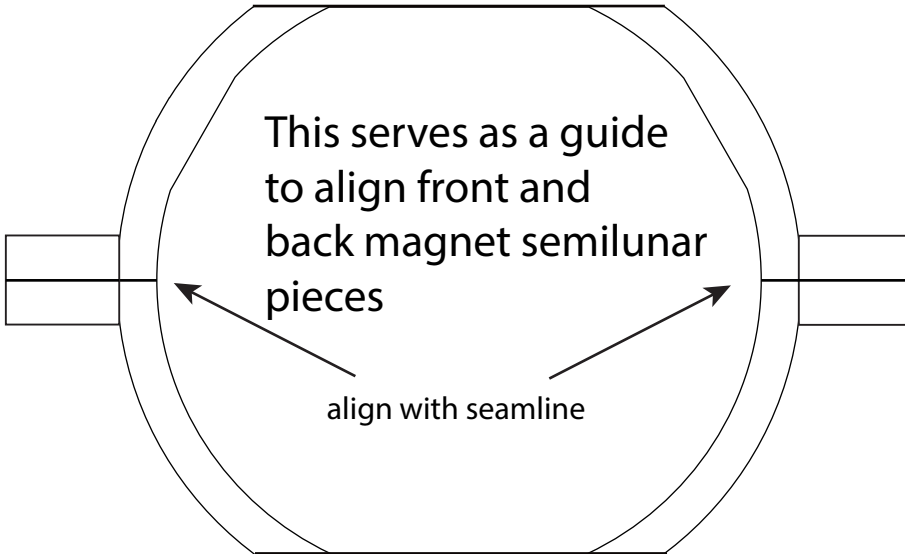

To be glued on Starship's upperdome top edge area

