



1:100 Scale

1 cm
1 inch

SpaceX Starship S28

Print on Cardstock (110 lbs)

Nosecone interior parts in red

LOX header tank

CH4 header tank

Forward flaps servo structures

5 Stack Segment

1

2

3

Header Tank pipe

COPV area

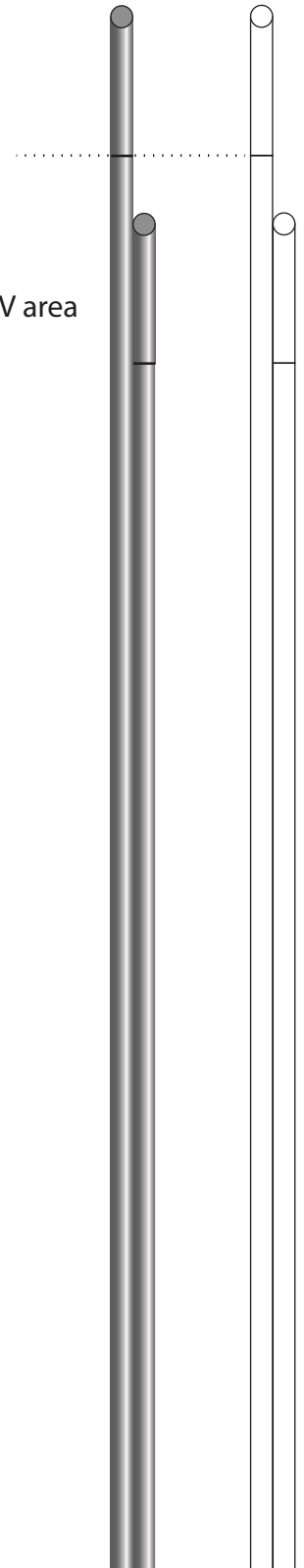
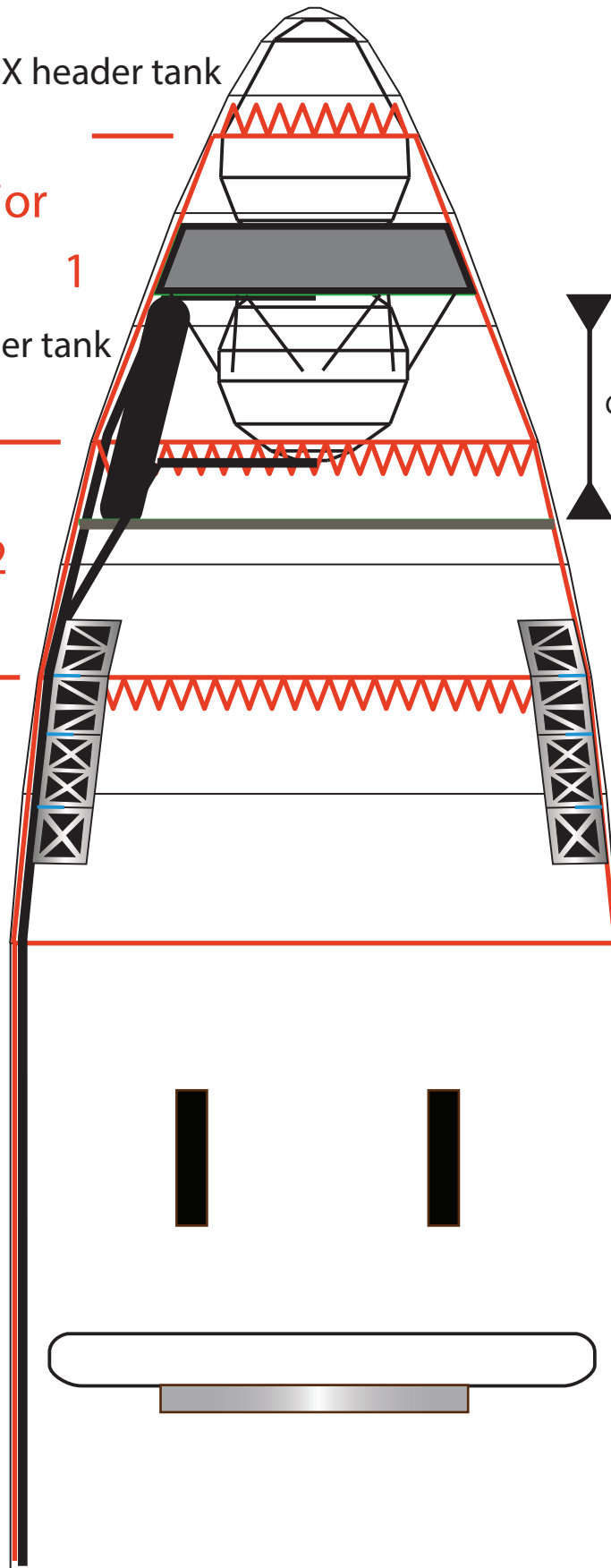



1:100 Scale



SpaceX Starship Nosecone interior

Print on Cardstock (110 lbs)

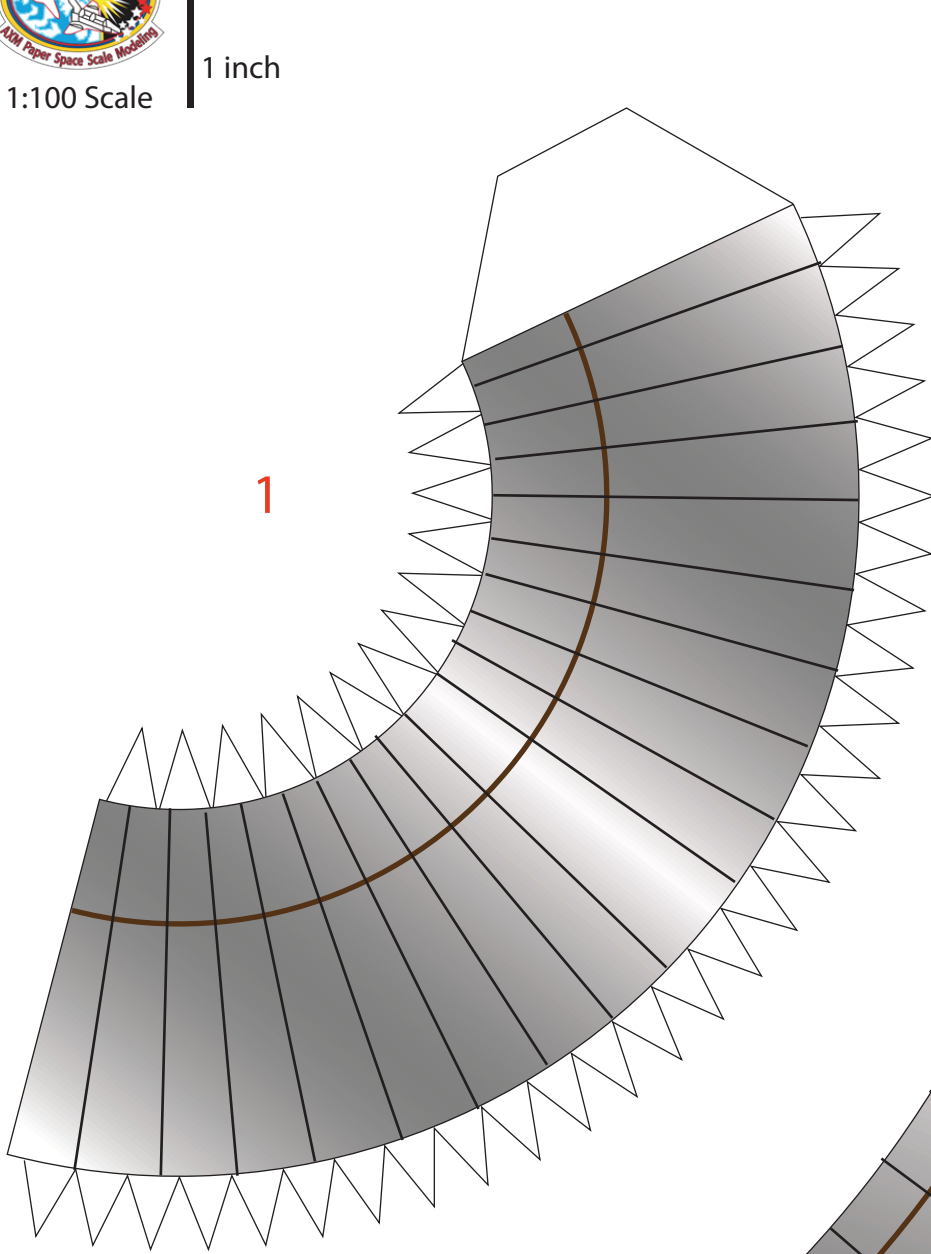

1

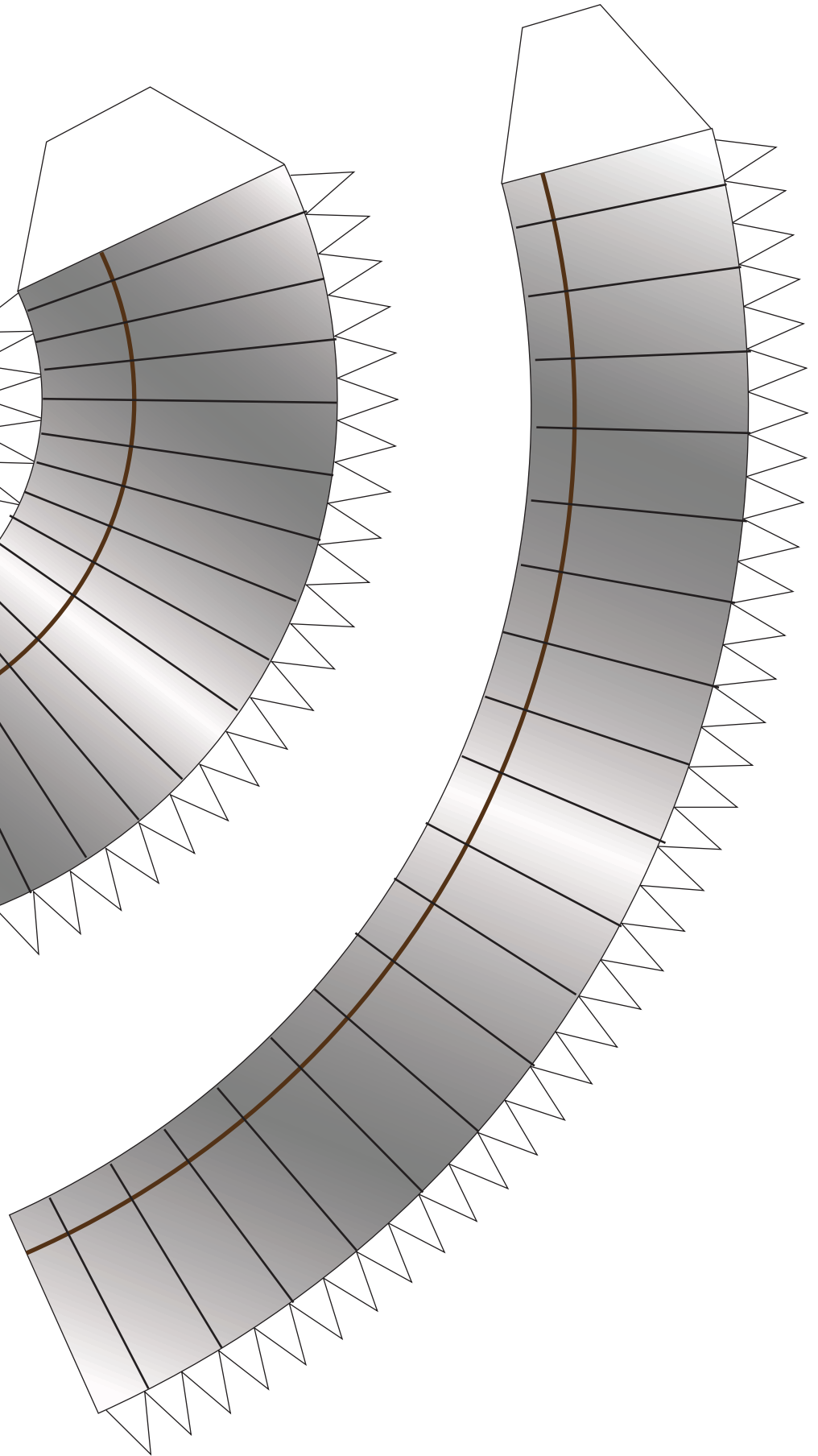

2



1:100 Scale



SpaceX Starship Nosecone interior

Print on Cardstock (110 lbs)

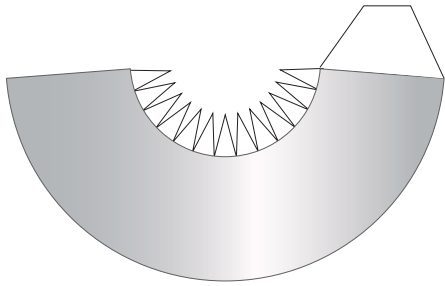

LOX header tank

Black dots point upwards

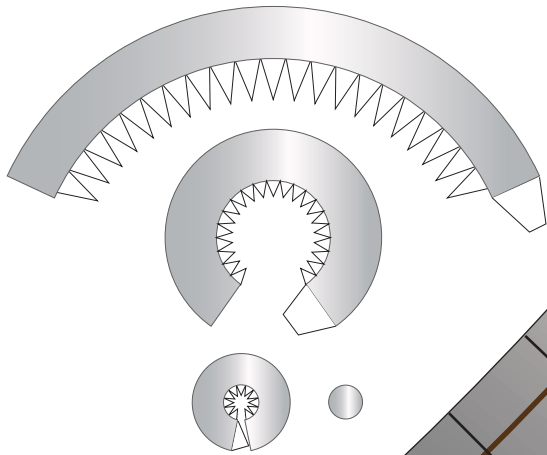
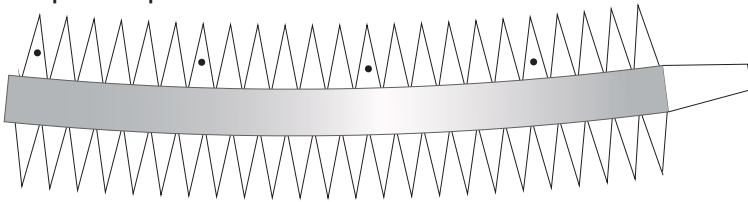

CH4 header tank

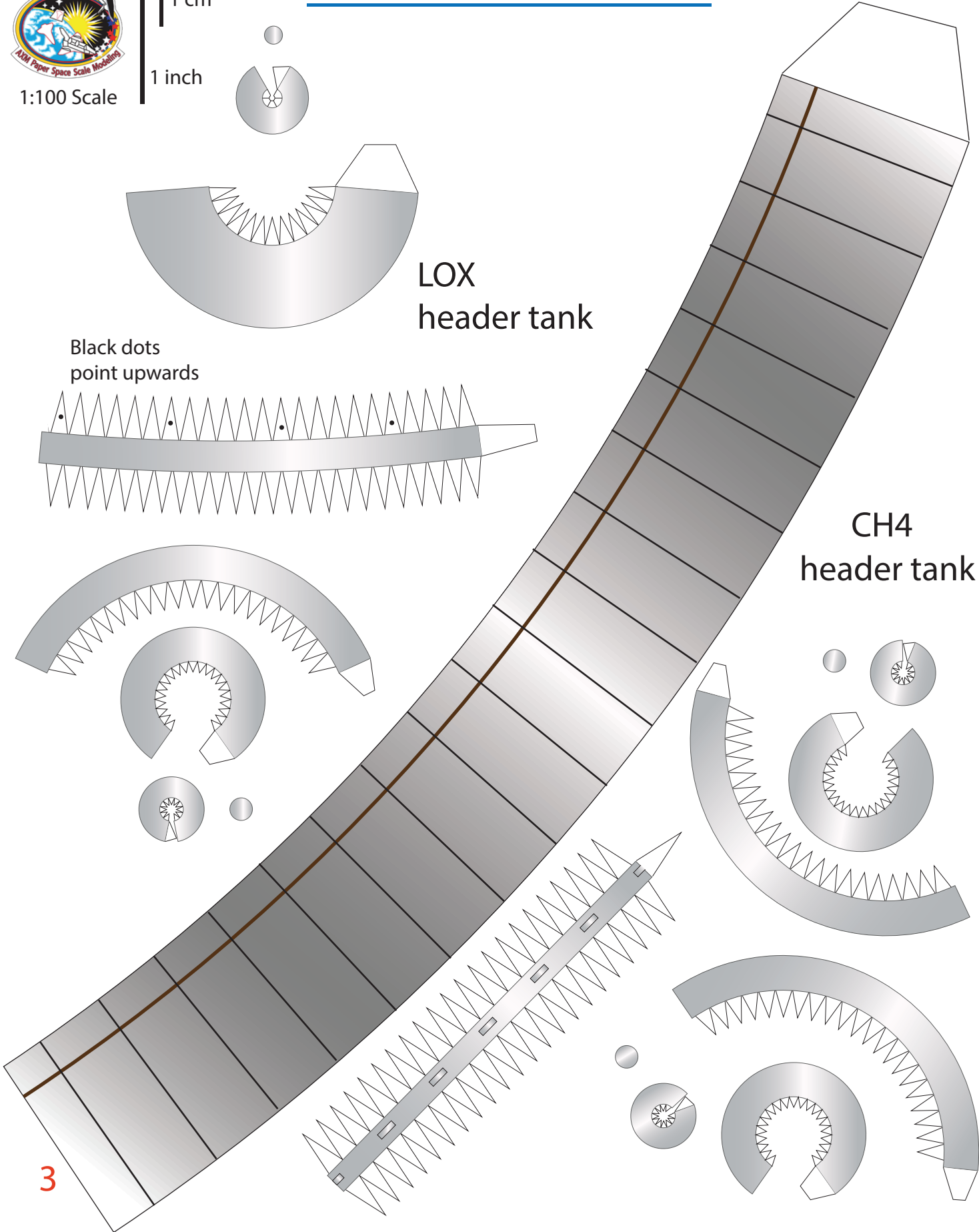
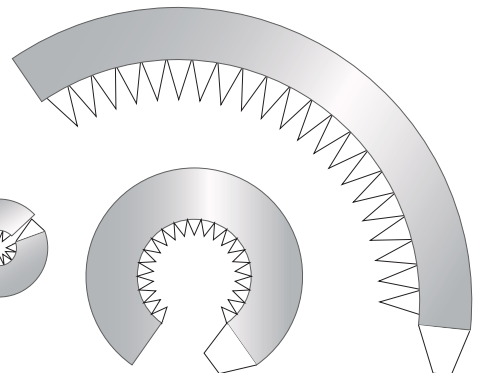
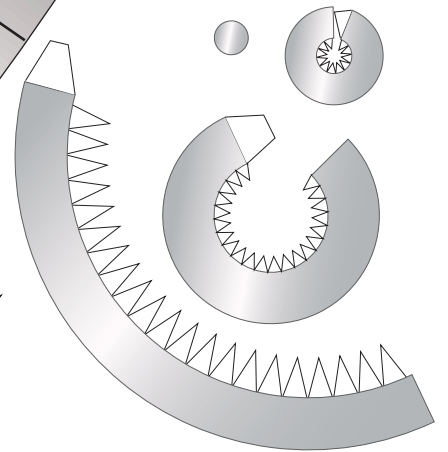

3



1:100 Scale



SpaceX Starship Header tanks support

Print on Cardstock (110 lbs)

LOX and CH4

Use for Ships 24, 25, 28

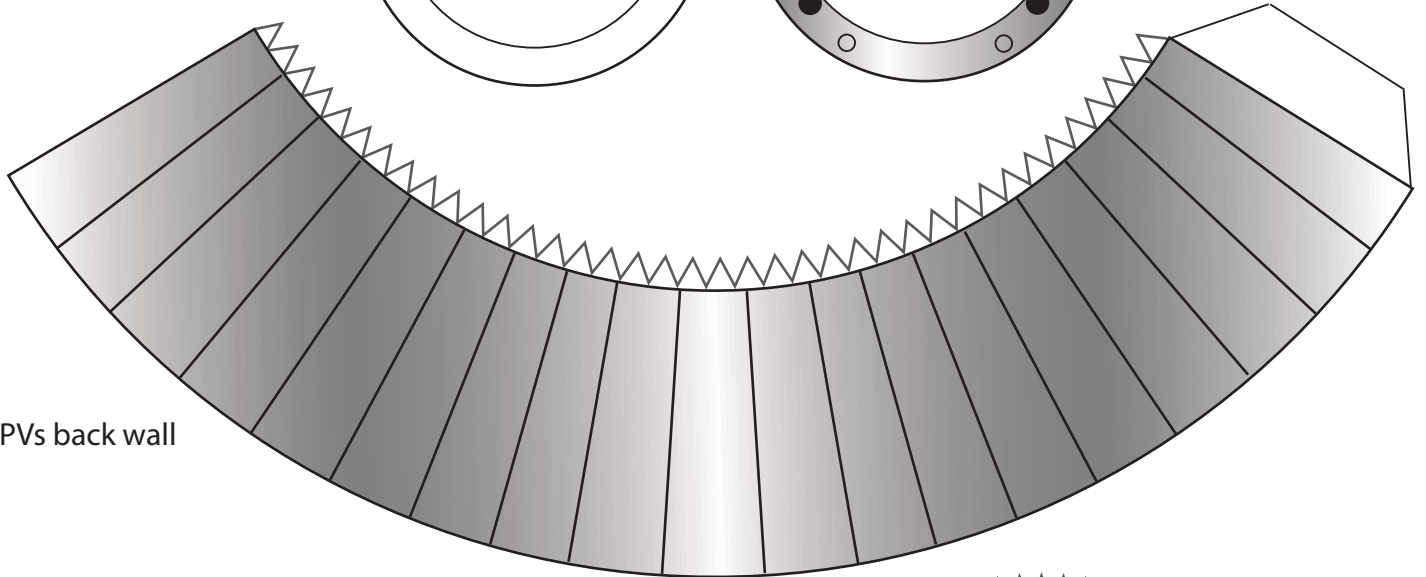
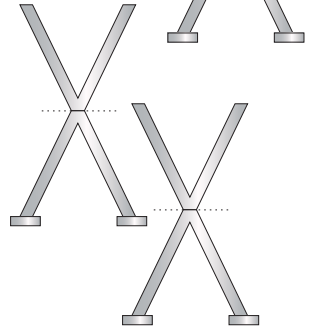
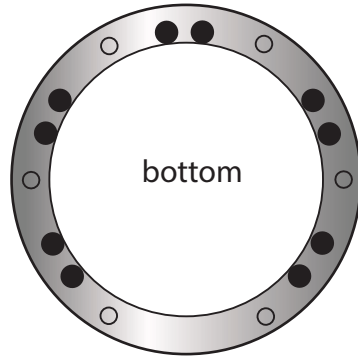
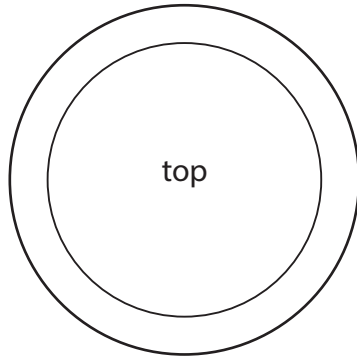
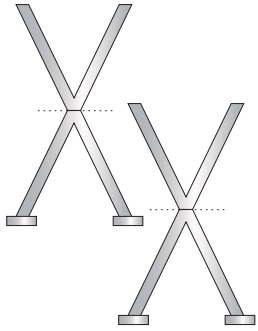
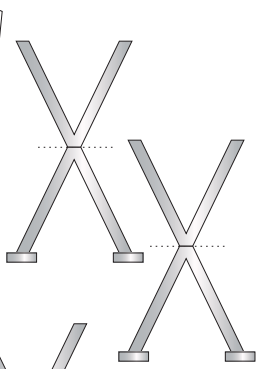
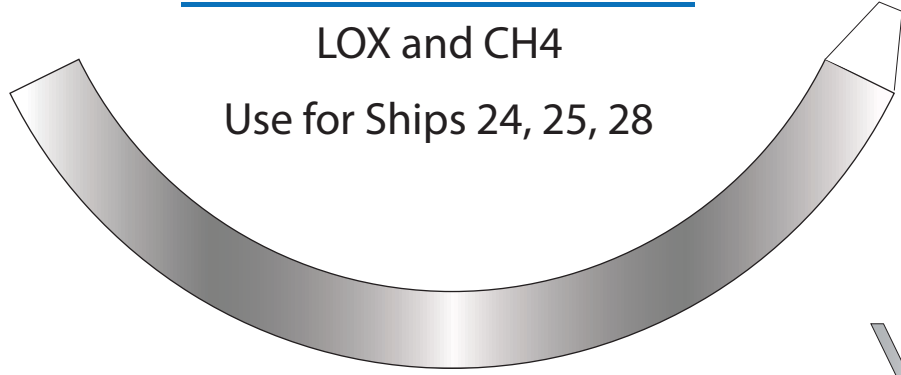

COPVs back wall

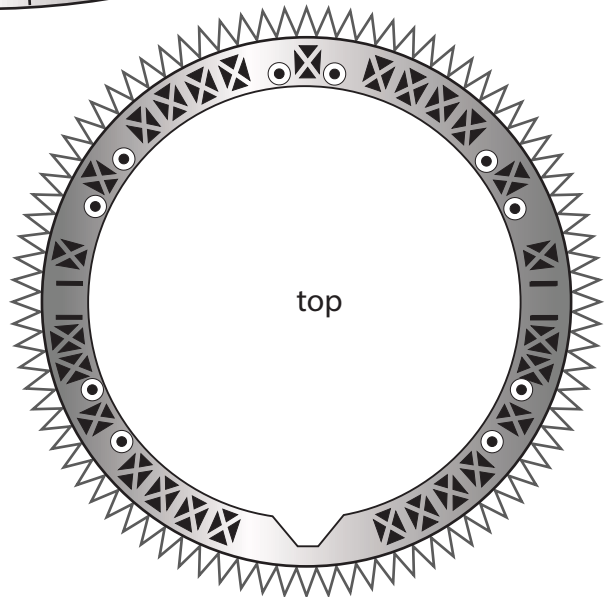
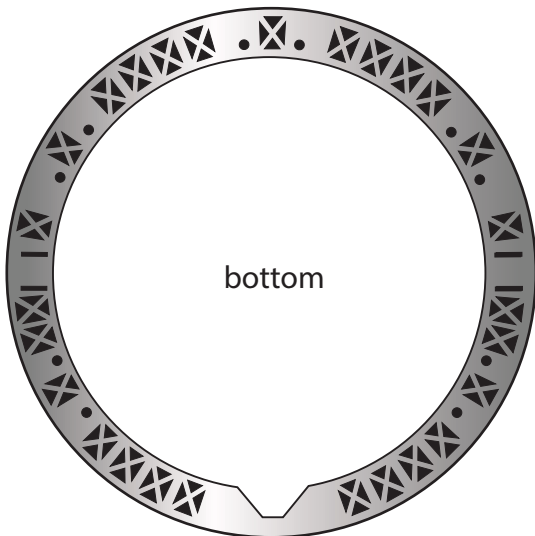



1:100 Scale



10 COPVs and Left Internal servo support

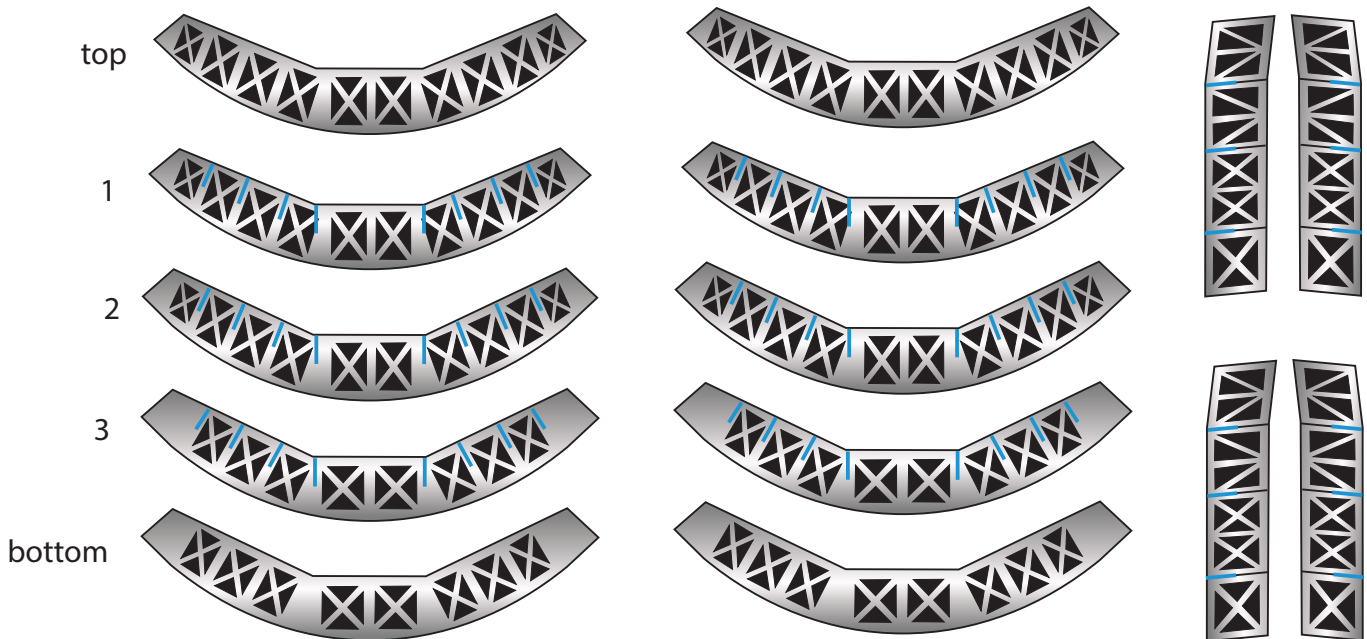
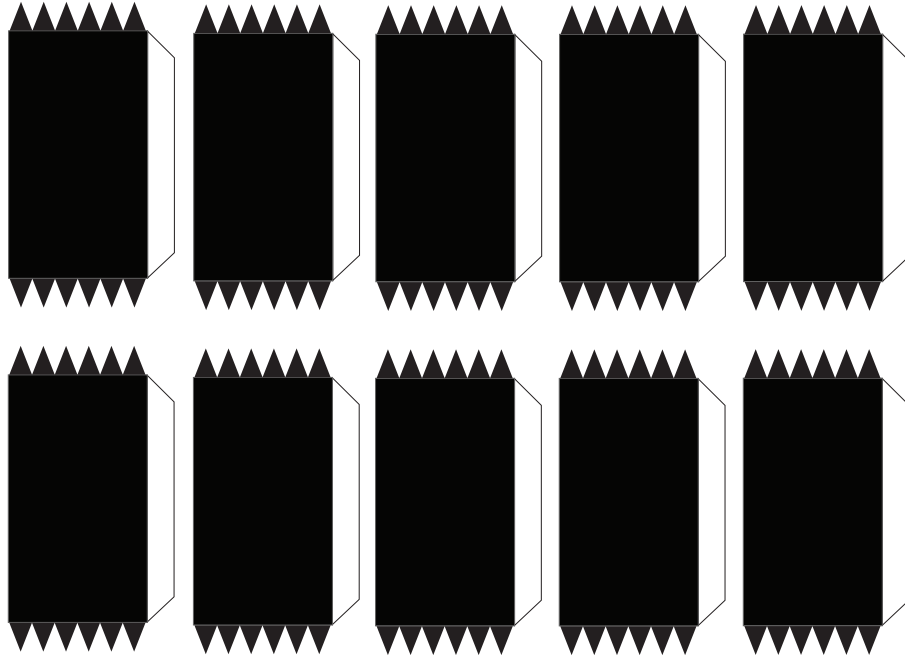



1:100 Scale



SpaceX Starship Nosecone interior

Print on Cardstock (110 lbs)

Right Internal servo support

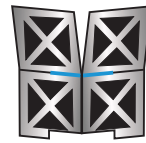
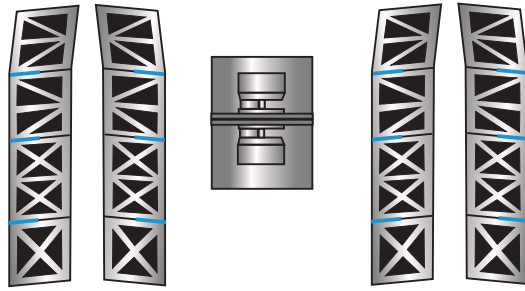

top



1



2

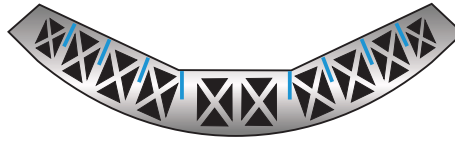

3

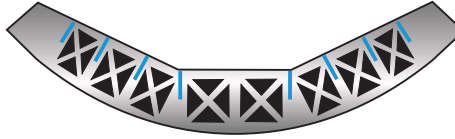
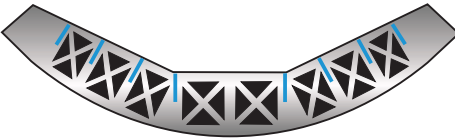

bottom

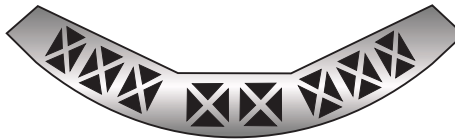



1 cm

1 inch

1:100 Scale

SpaceX Starship S28

Print on Cardstock (110 lbs)

Nosecone-body 5 ring stack interior detail

connecting tabs
for nosecone

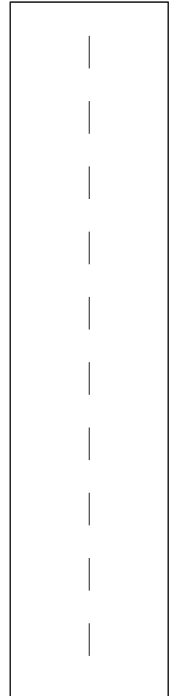
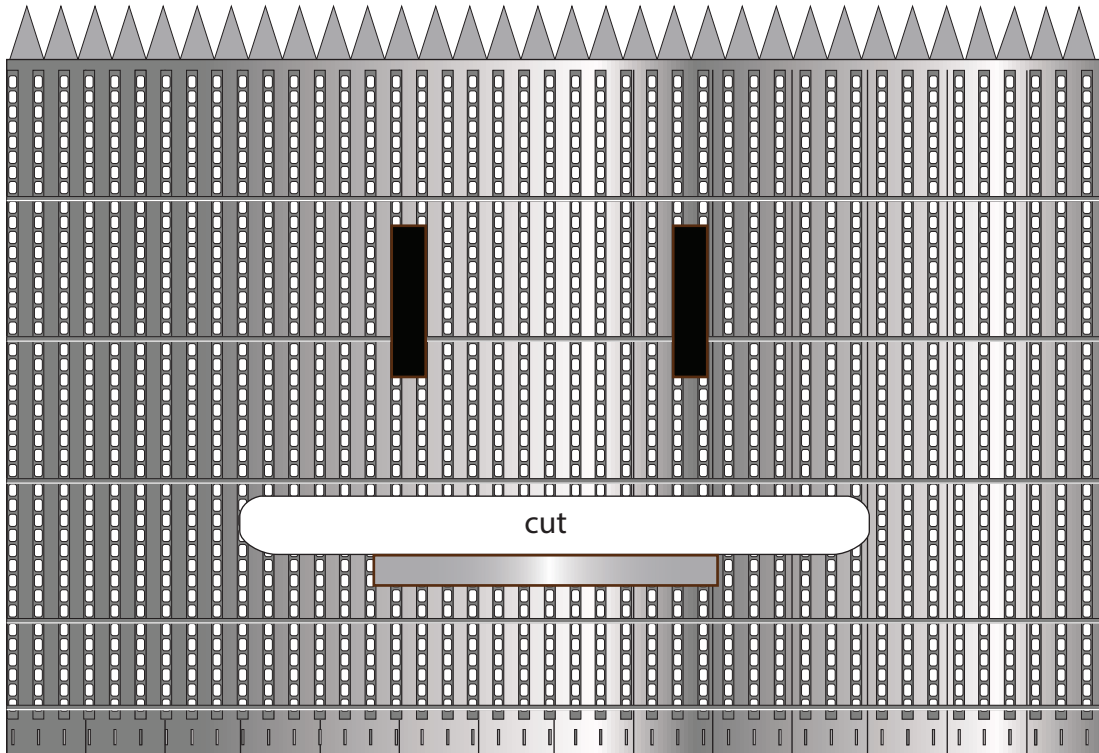

connecting tabs
for nosecone

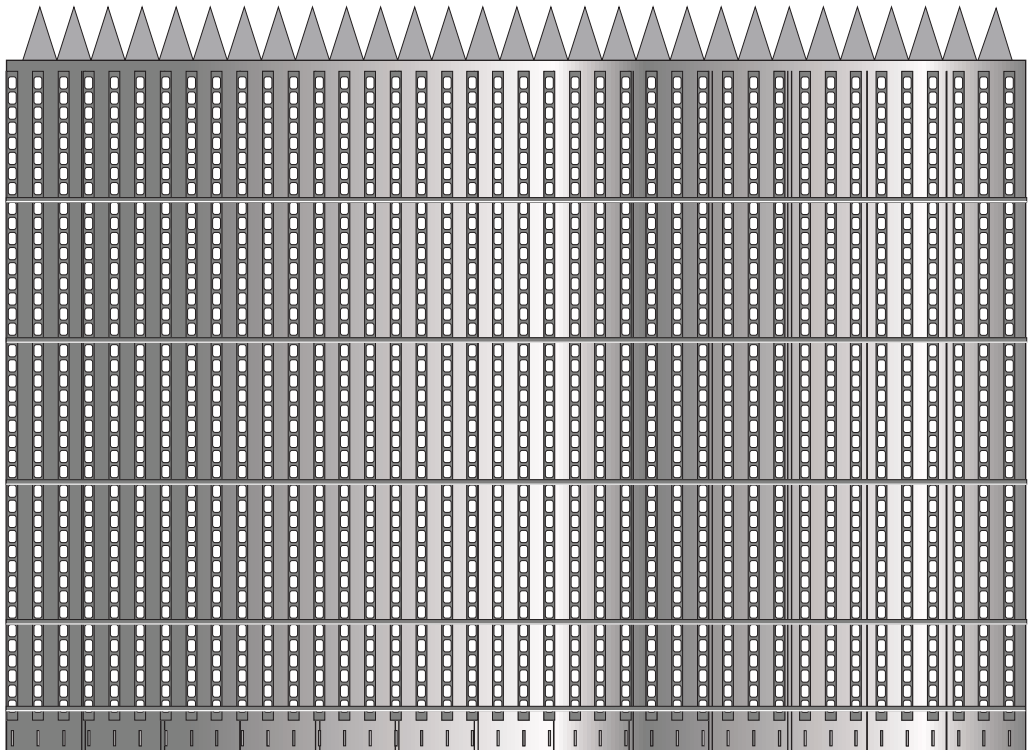



1:100 Scale



SpaceX Starship S28

Print on Cardstock (110 lbs)

Payload Door system

Door pistons

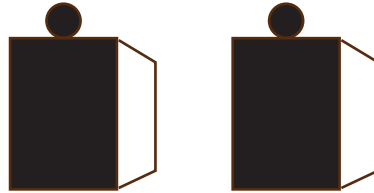

Front

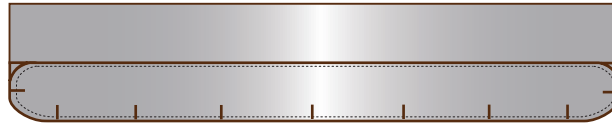

Middle



Back

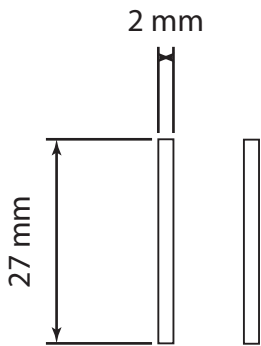
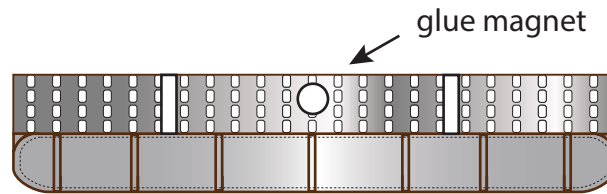

Use 2 rods (cotton swabs)

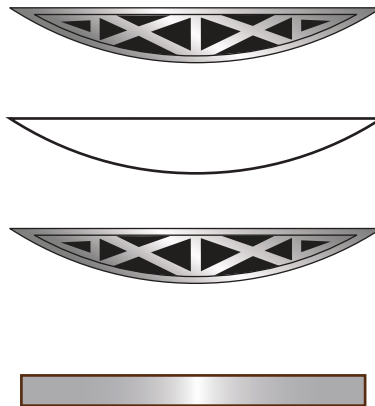

Sandwich these 3 parts and glue them beneath door edge

Magnet handler

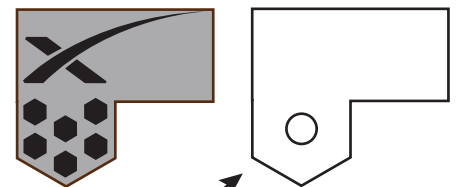



1:100 Scale



SpaceX Starship S28

Print on Cardstock (110 lbs)

Use for payload version

Nosecone-body 5 ring stack

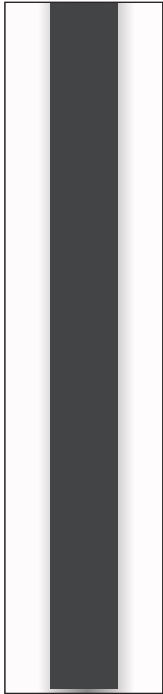

Umbilical side

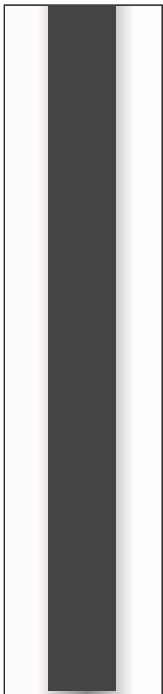
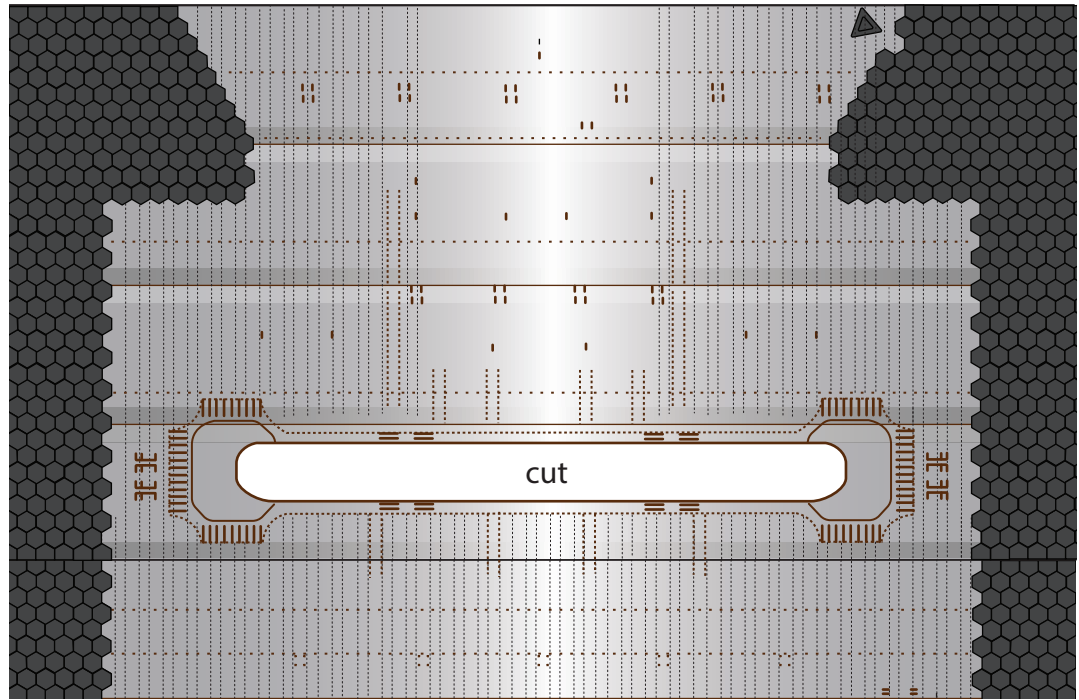

Front

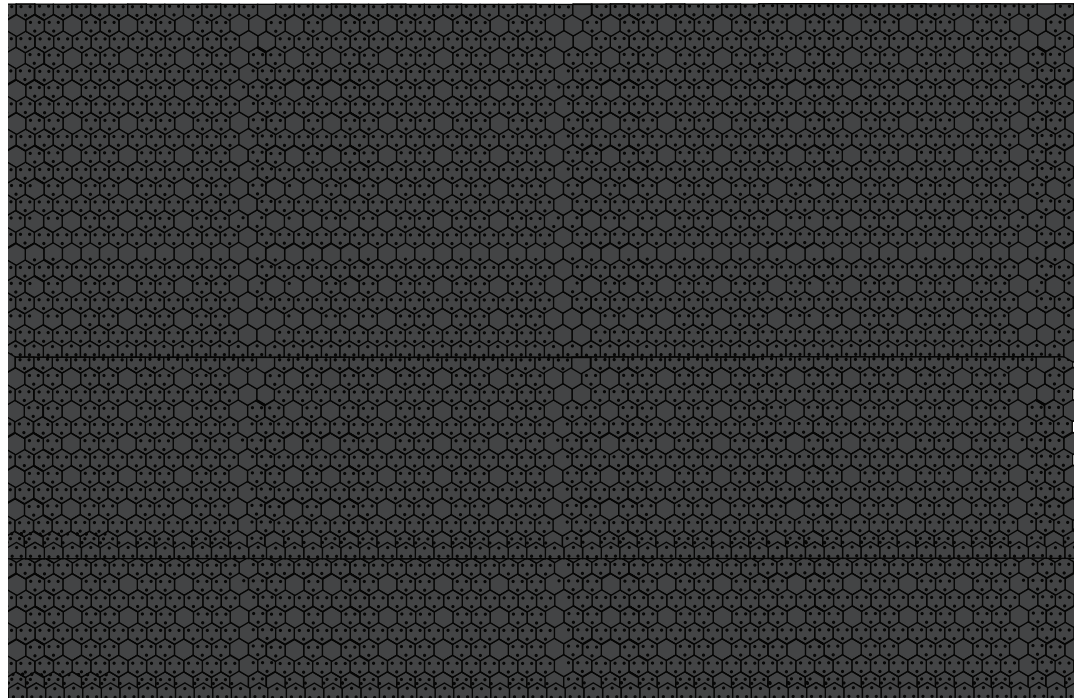

Connectors for 5 ring stack and body





1 cm

1 inch

1:100 Scale

SpaceX Starship

Print on Cardstock (110 lbs)

To be glued on Starship's 4 or 5 ring segment section bottom edge

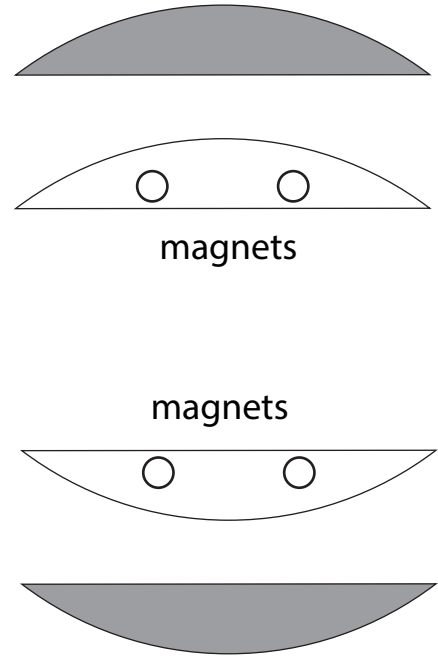
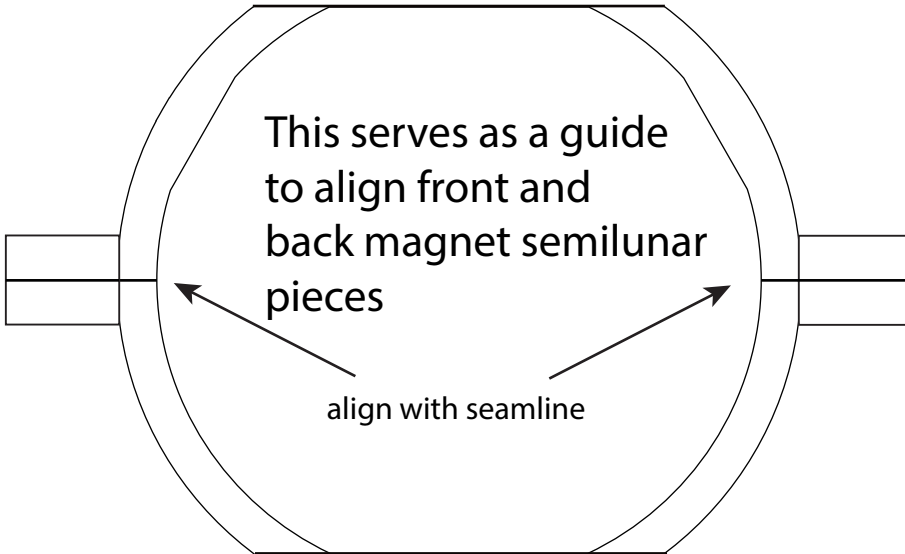

To be glued on Starship's upperdome top edge area

