

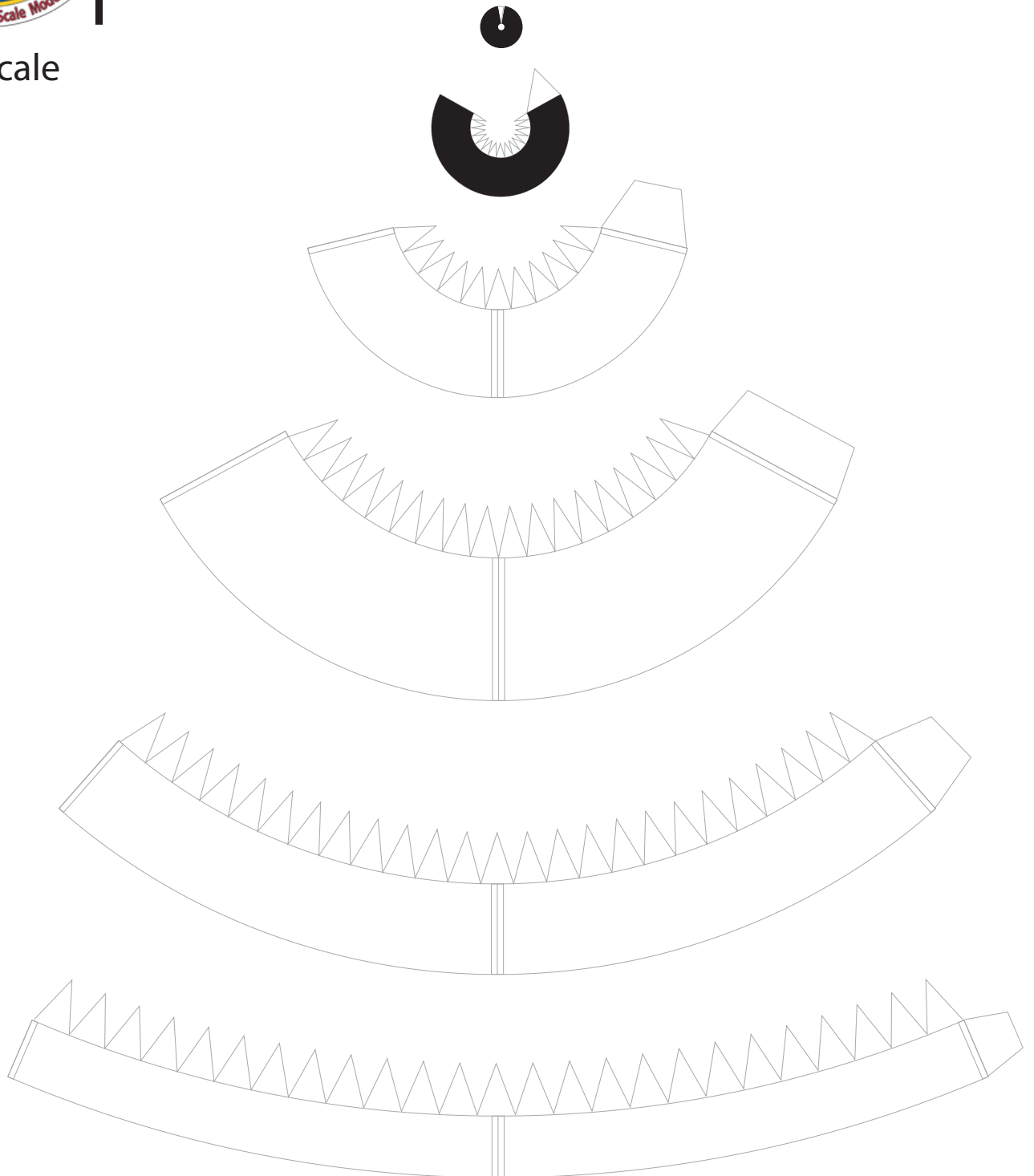

Delta IV Common Booster Core Fairing Nosecone

Print on Cardstock (110 lbs)

1:96 Scale





Delta IV Heavy

Print on Cardstock (110 lbs)

NROL-91

1:96 Scale

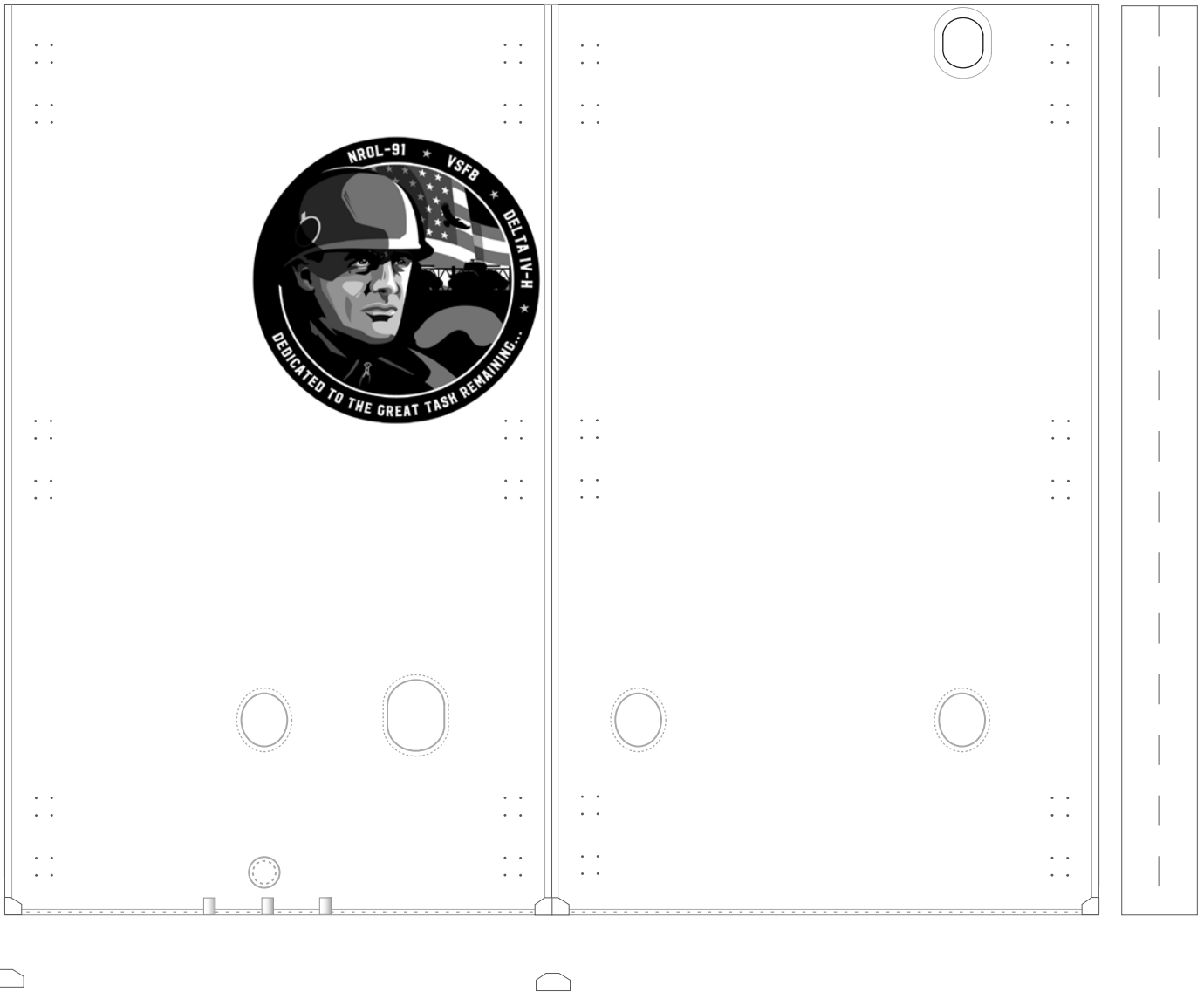

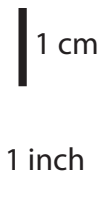

NROL-91 Insterstage

Print on Cardstock (110 lbs)

1:96 Scale

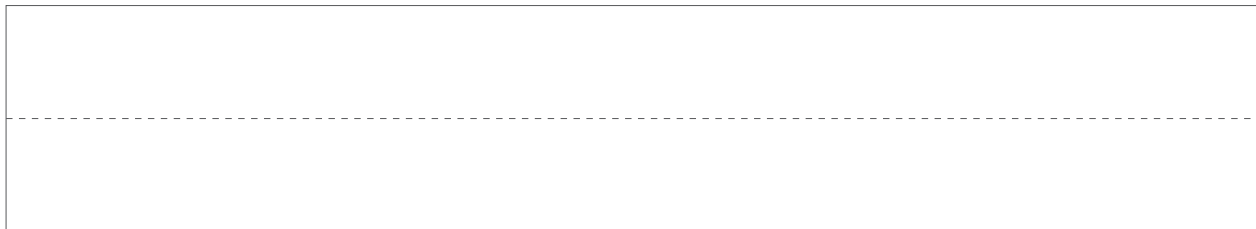
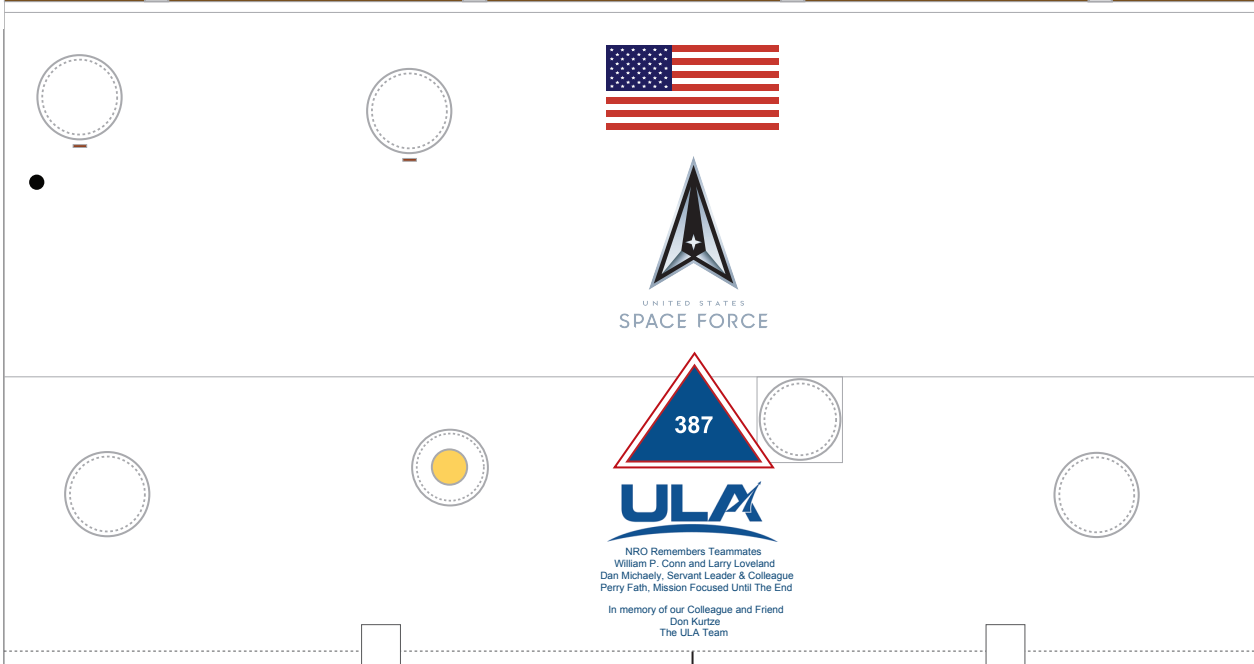
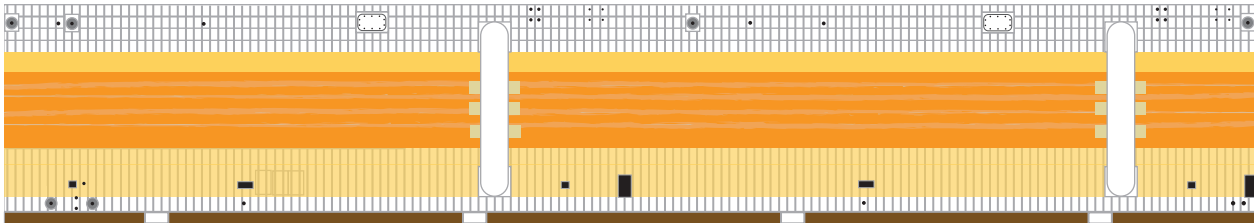
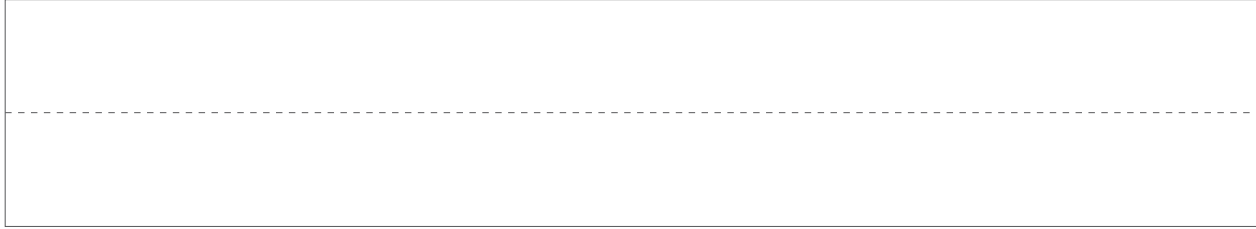



NROL-91

Print on Cardstock (110 lbs)

Delta IV Common Booster Core Center

1:96 Scale

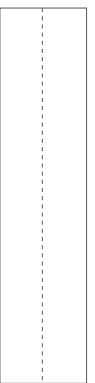
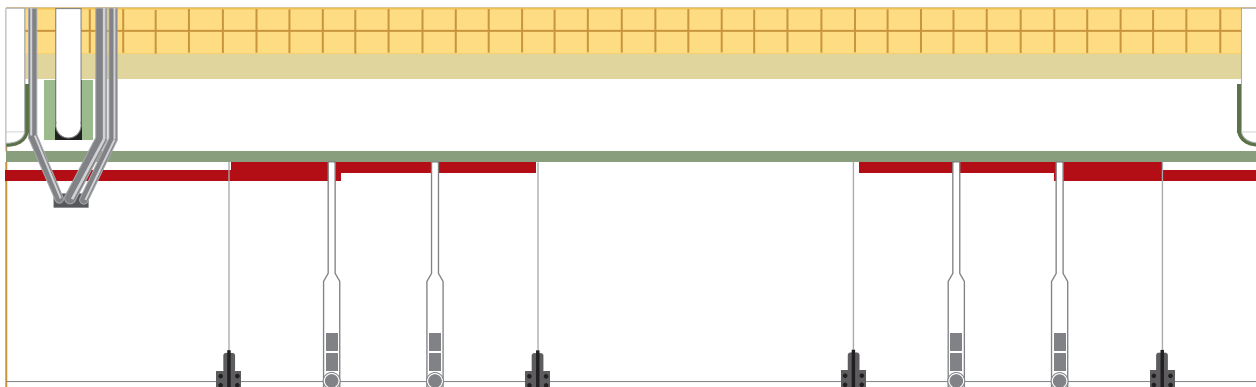
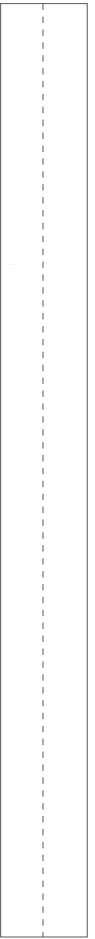
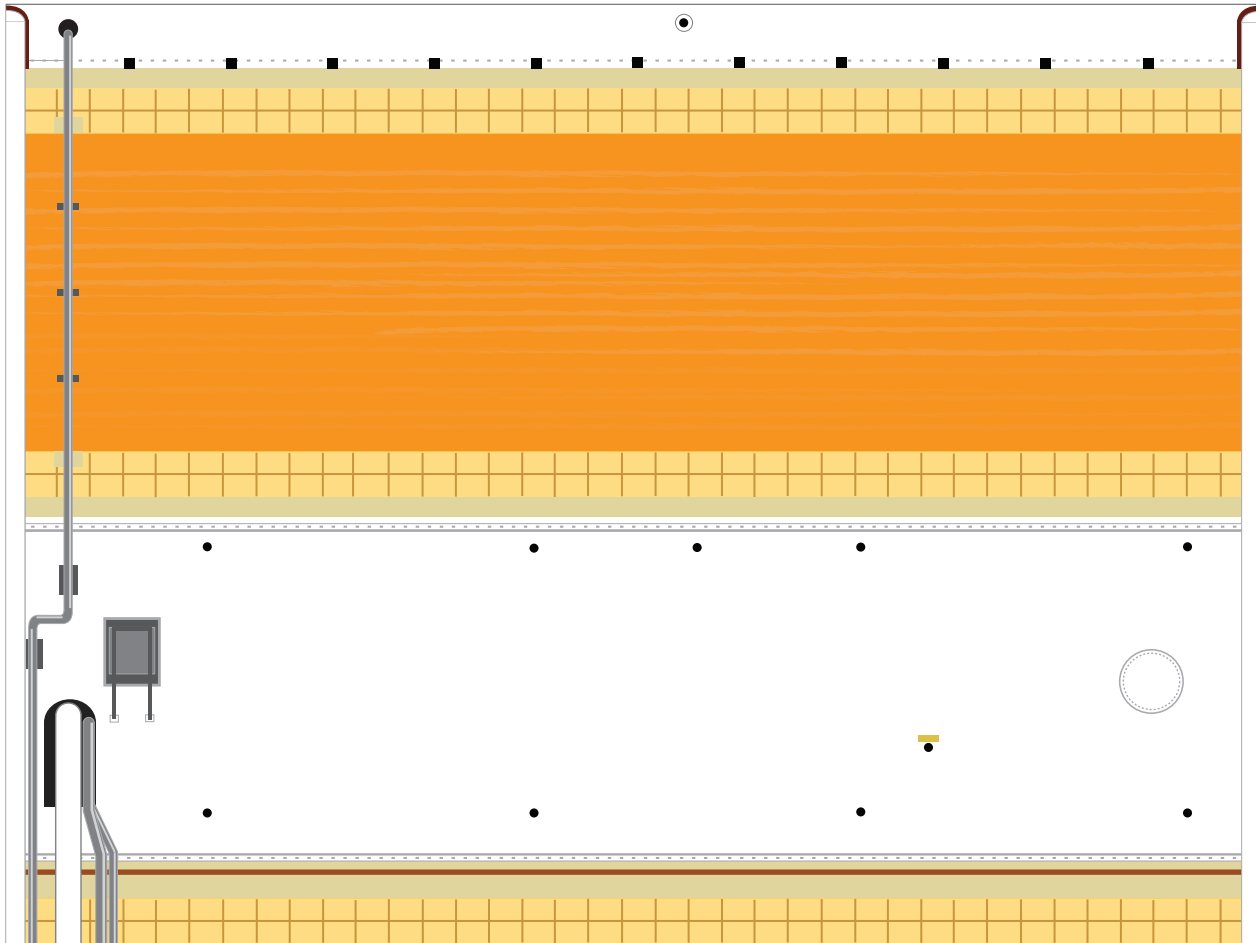



Center Delta IV Common Booster Core

Print on Cardstock (110 lbs)

1:96 Scale

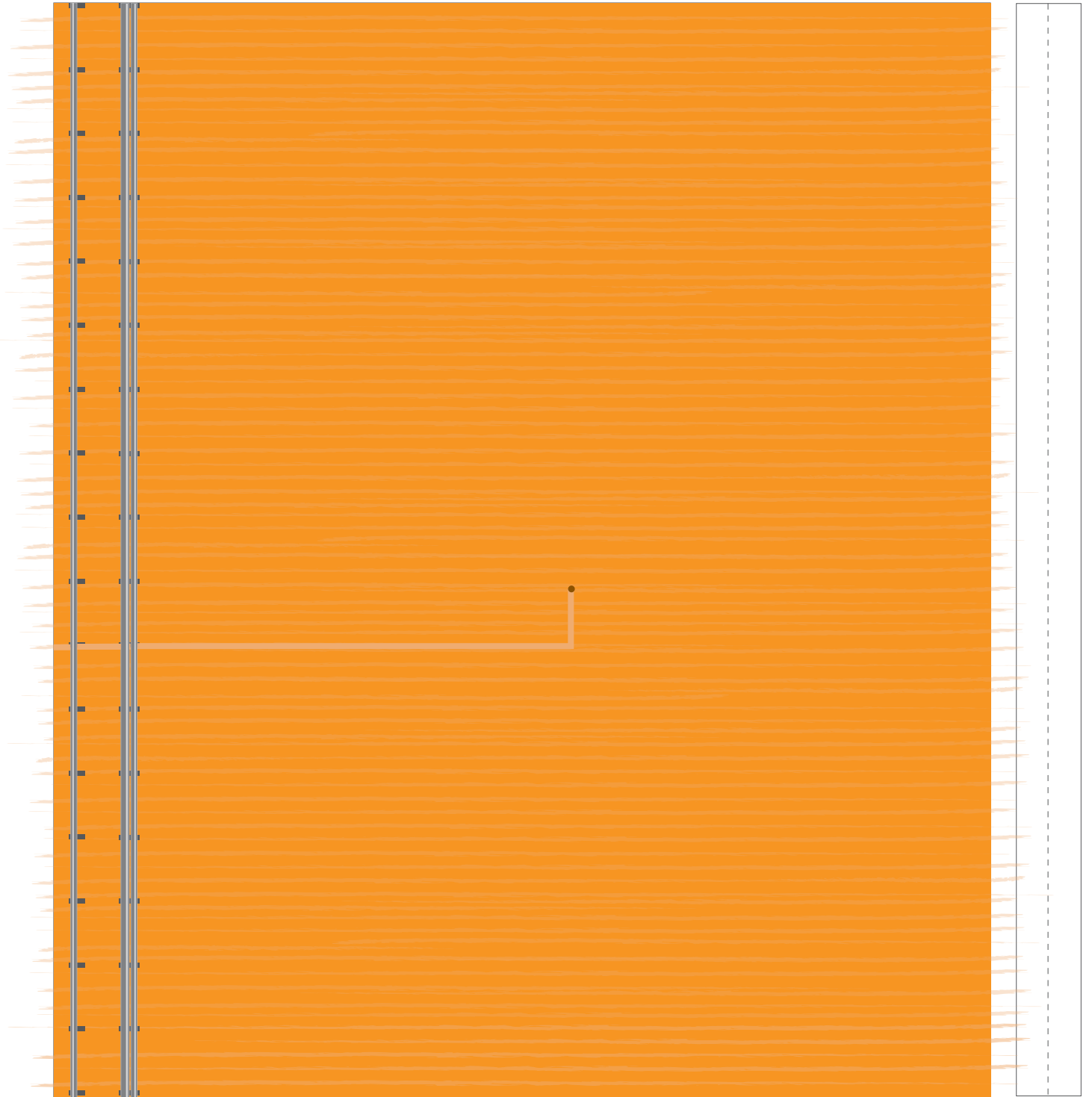



NROL-91

Print on Cardstock (110 lbs)

Delta IV Common Booster Core Left

1:96 Scale

Align nosecone seam

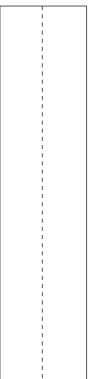
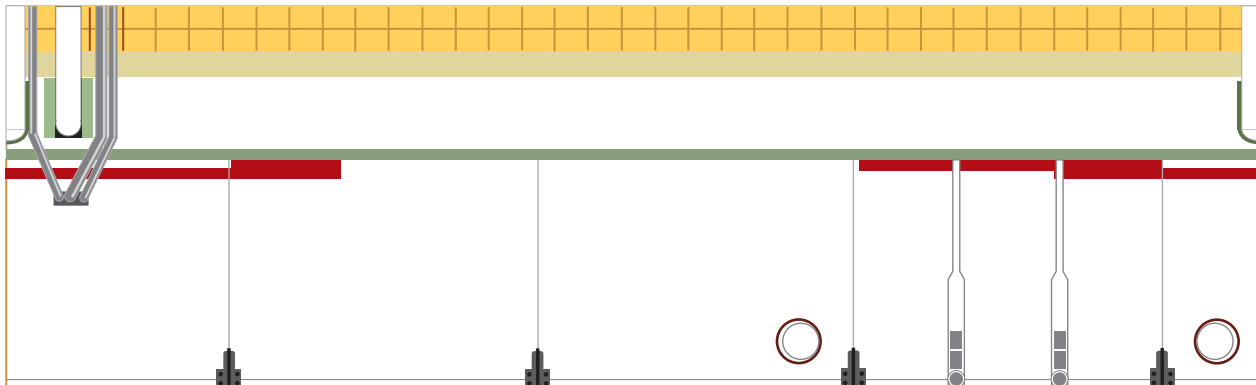
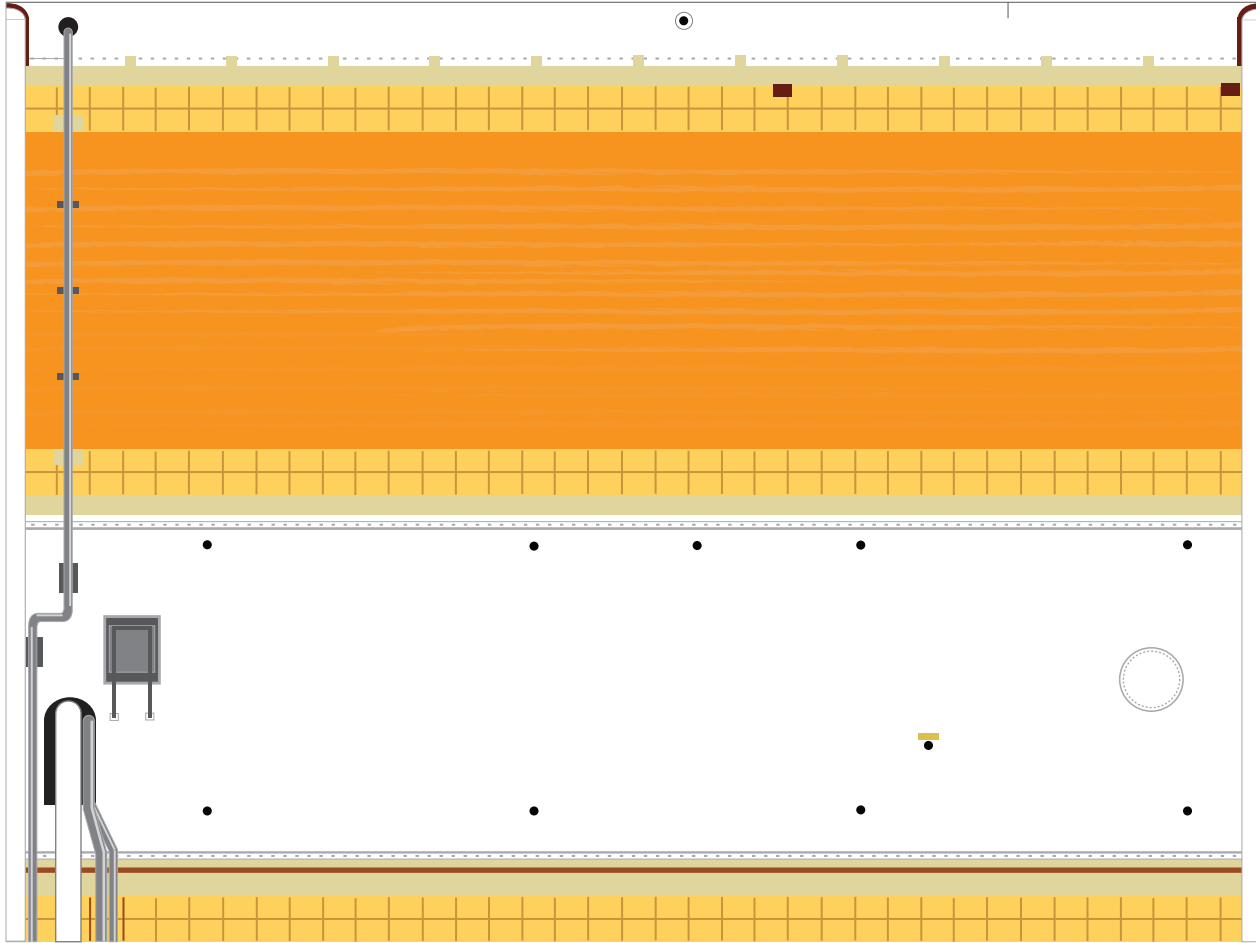



Left Delta IV Common Booster Core

Print on Cardstock (110 lbs)

1:96 Scale

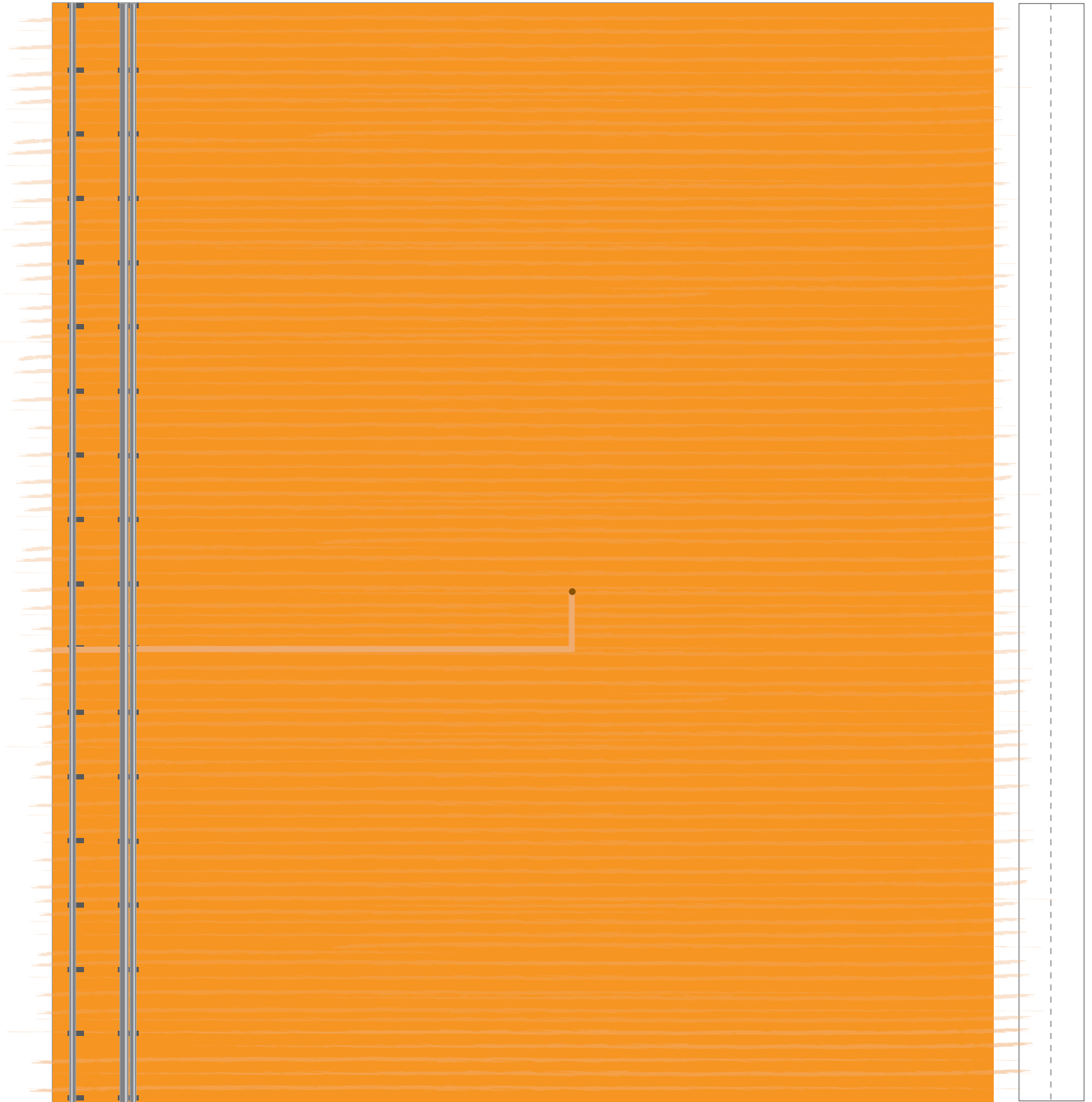



NROL-91

Print on Cardstock (110 lbs)

Delta IV Common Booster Core Right

1:96 Scale

Align nosecone seam

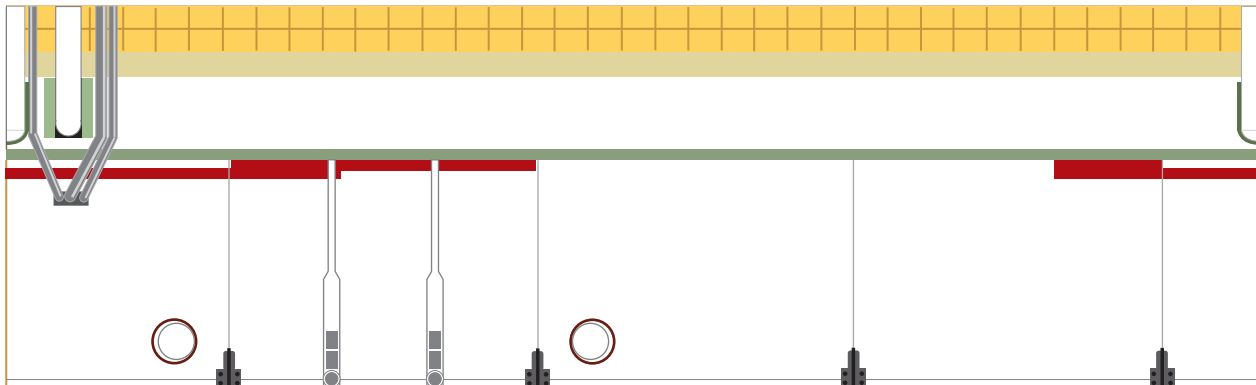
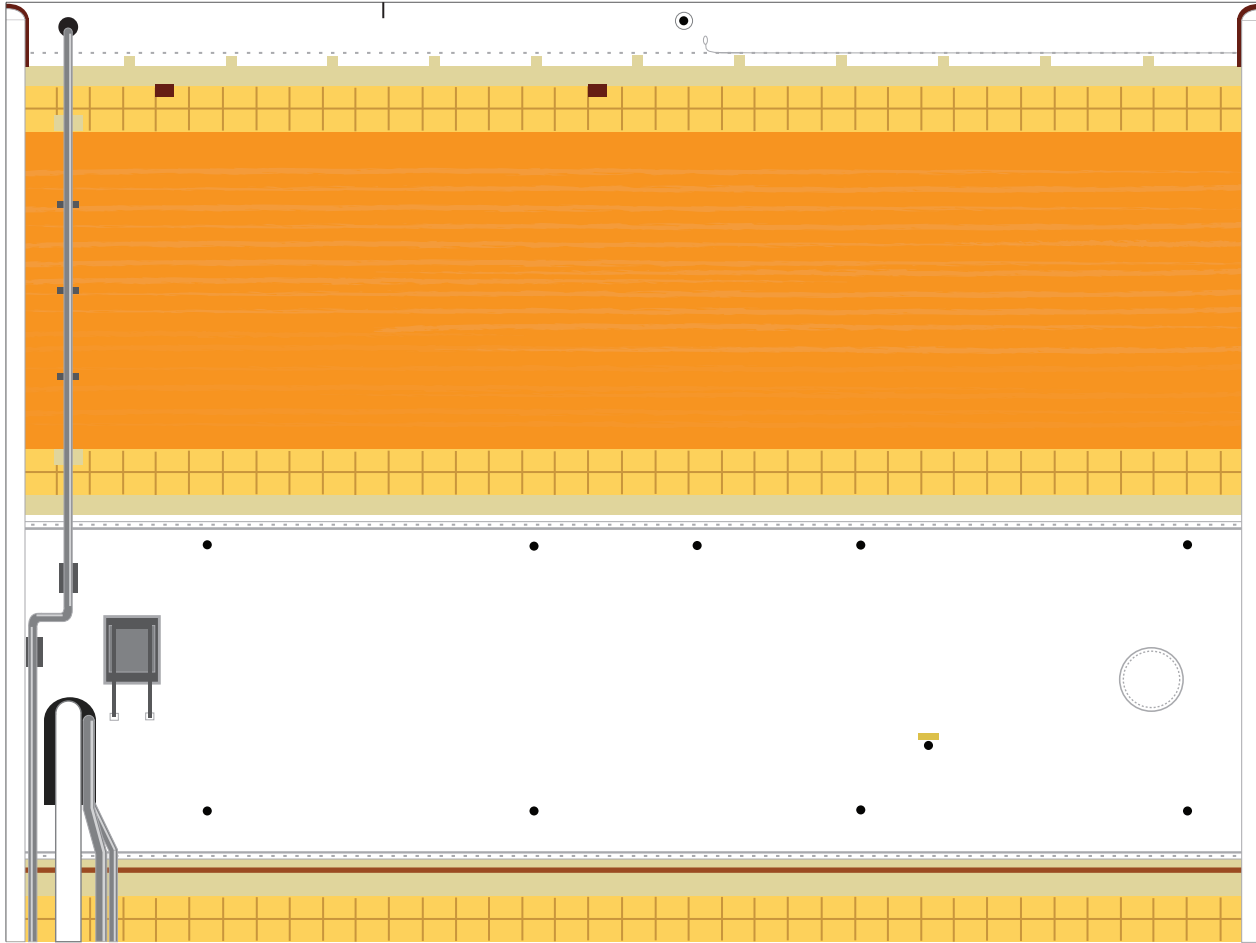



Right Delta IV Common Booster Core

Print on Cardstock (110 lbs)

1:96 Scale

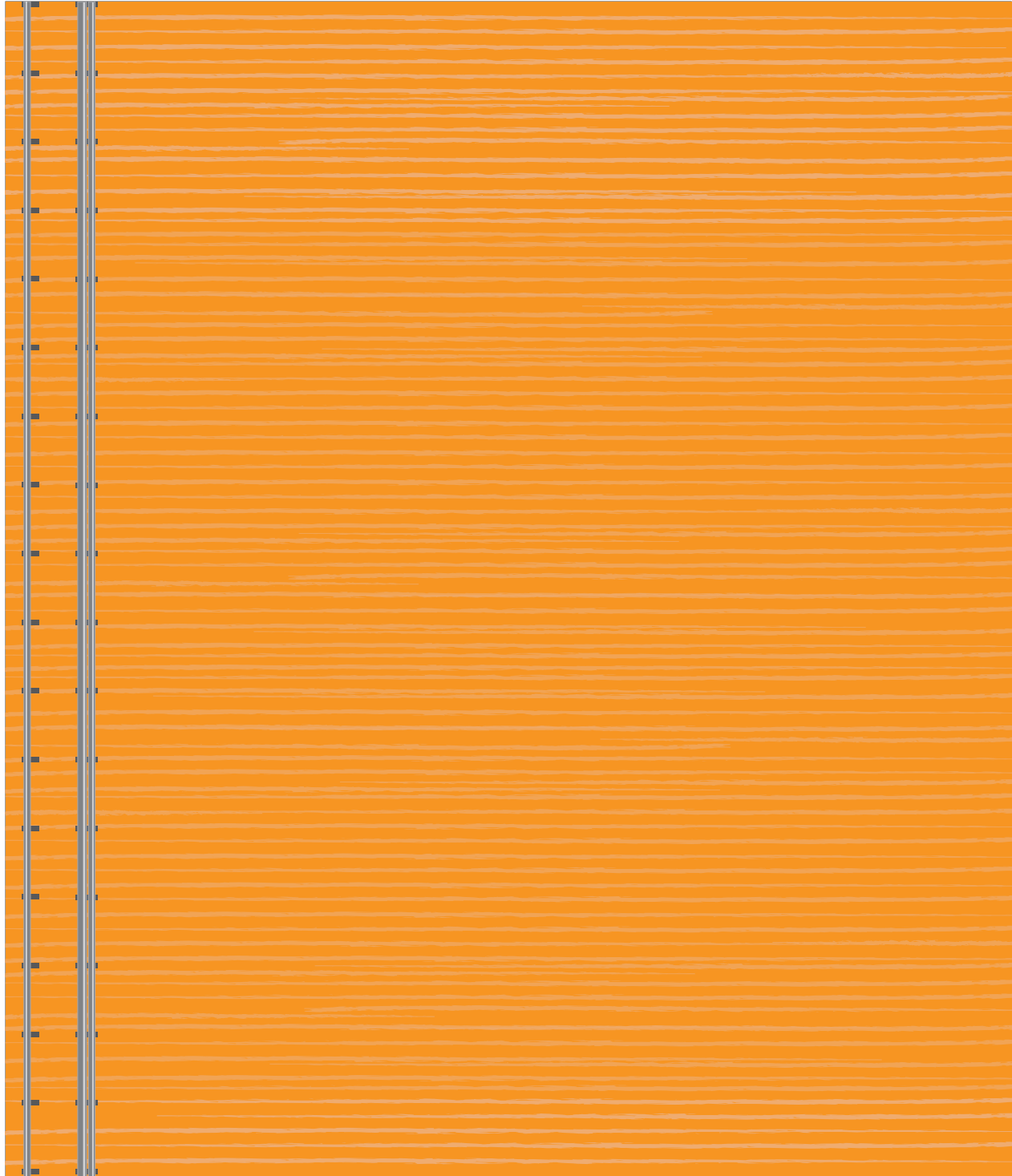



Print on Cardstock (110 lbs)

Delta IV Common Booster Core Nosecone

Print X 2

1:96 Scale

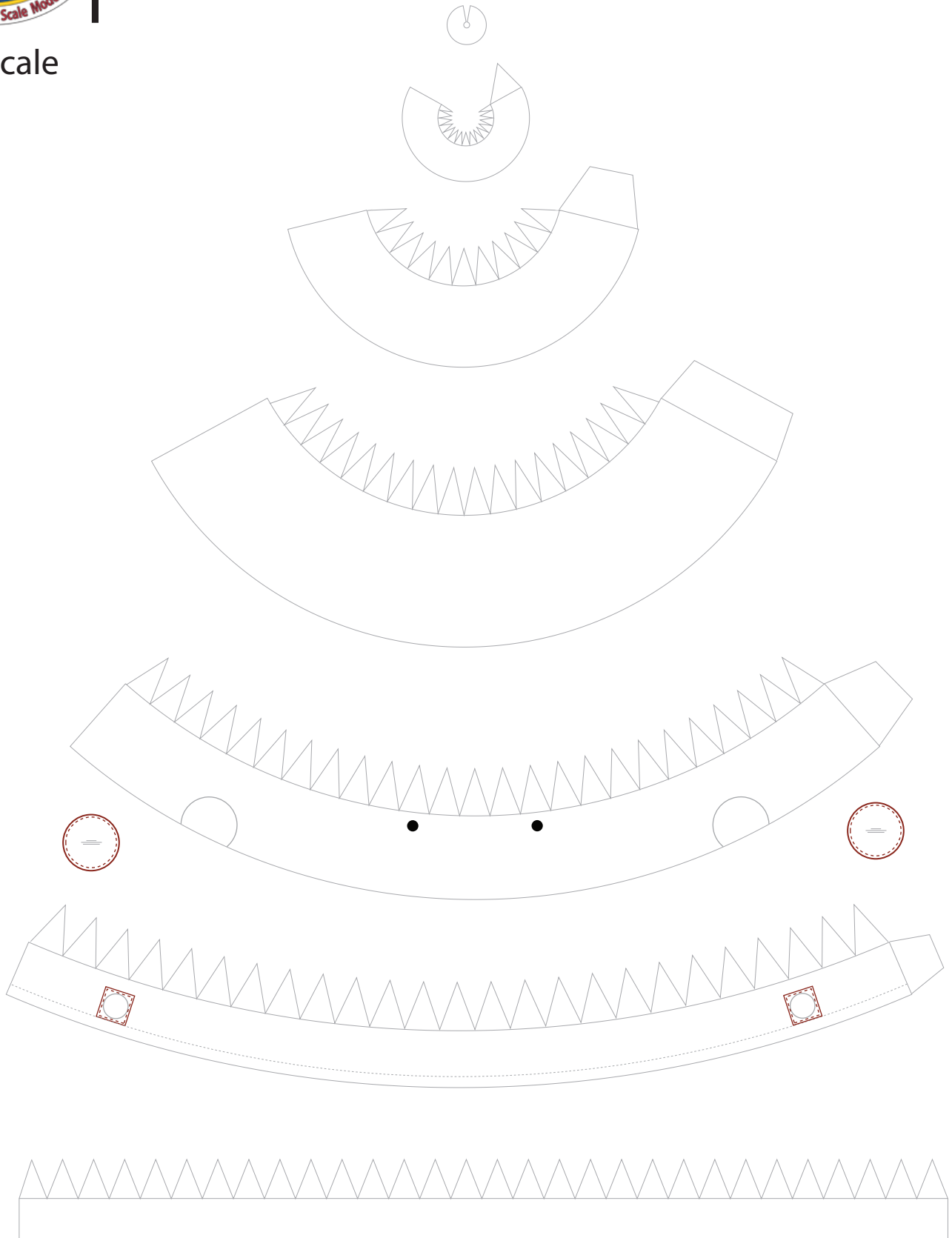

Connector for Common Booster Core



1 cm
1 inch

Delta IV Common Booster Core Attachments

Print on Cardstock (110 lbs)

1:96 Scale

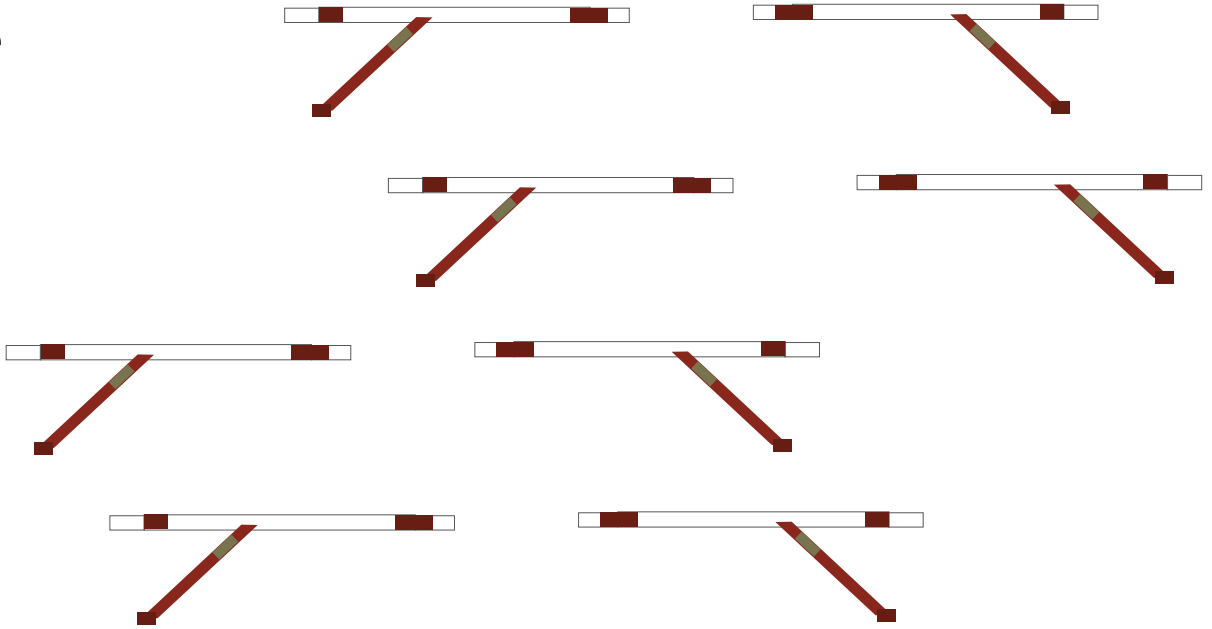

Center CBC
INTERSTAGE

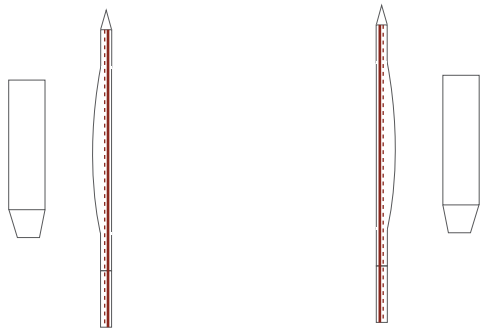

L CBC

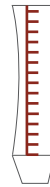

R CBC

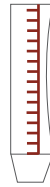

L CBC lower
attachments

R CBC lower
attachments

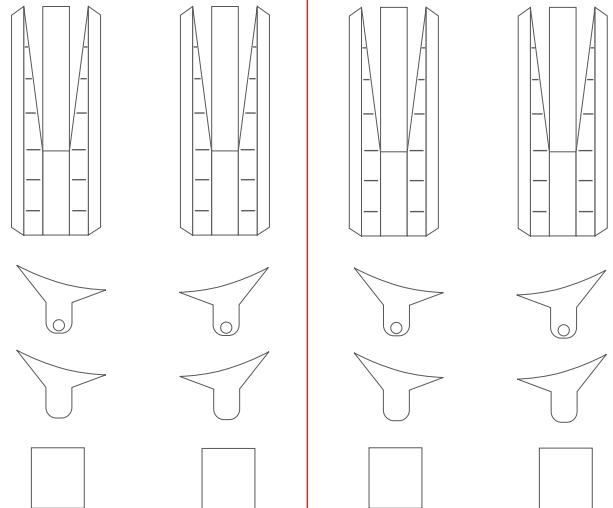

Center CBC lower attachments

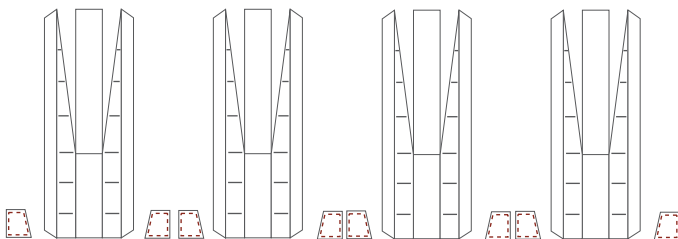



Delta IV Common Booster Core Connectors

Print on Cardstock (110 lbs)

1:96 Scale

Blank rectangular area with a dashed horizontal line for a fold.

Blank rectangular area with a dashed horizontal line for a fold.

Blank rectangular area with a dashed horizontal line for a fold.

Blank rectangular area with a dashed horizontal line for a fold.

Blank rectangular area with a dashed horizontal line for a fold.

Blank rectangular area with a dashed horizontal line for a fold.

Blank rectangular area with a dashed horizontal line for a fold.



Delta IV Common Booster Core

Engine section

Print on Cardstock (110 lbs)

Print x 3

1:96 Scale

CBC bottom connector

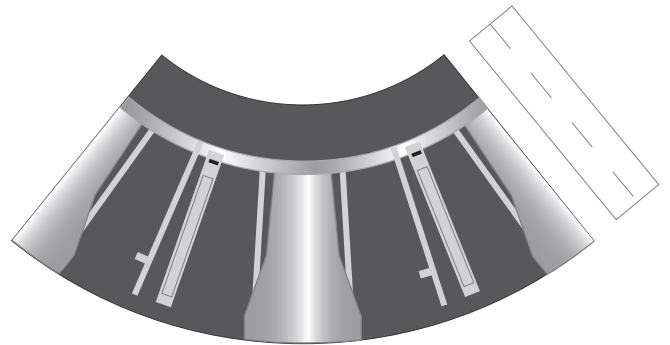
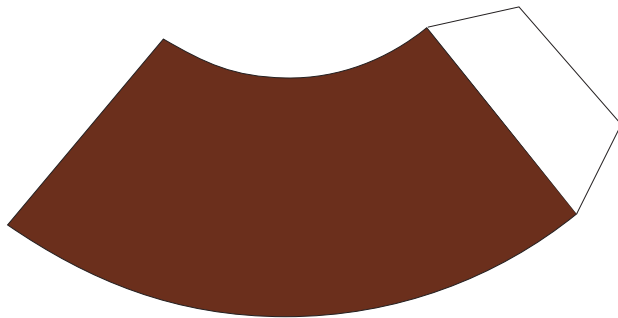
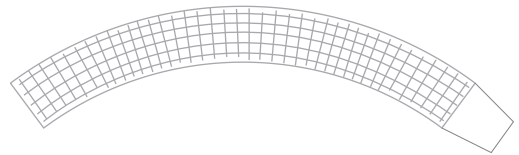
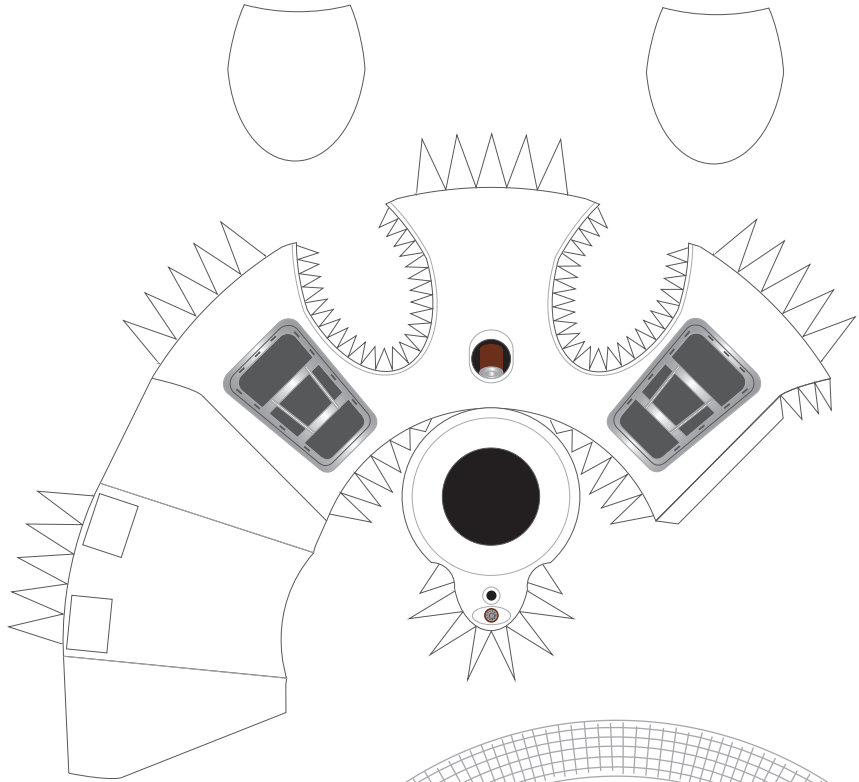
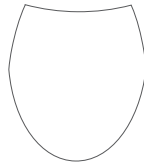
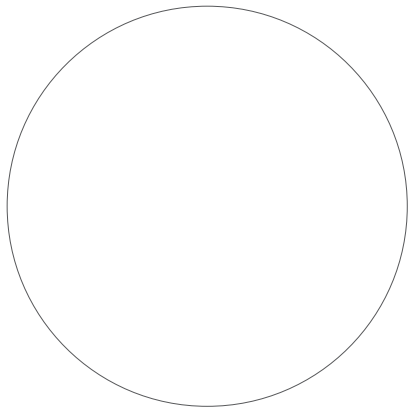
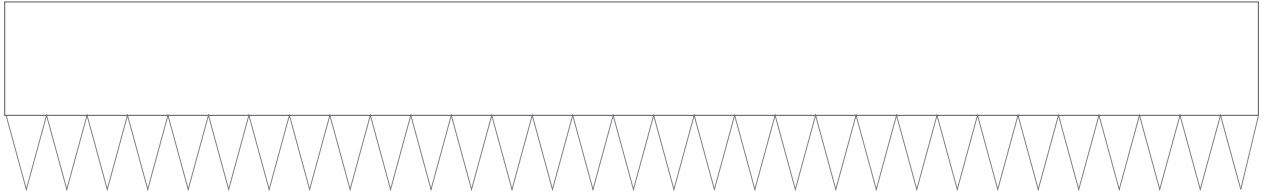



1 cm
1 inch

Delta IV Common Booster Core

Fuel Lines

Print x 3



Print on Cardstock (110 lbs)

1:96 Scale

