

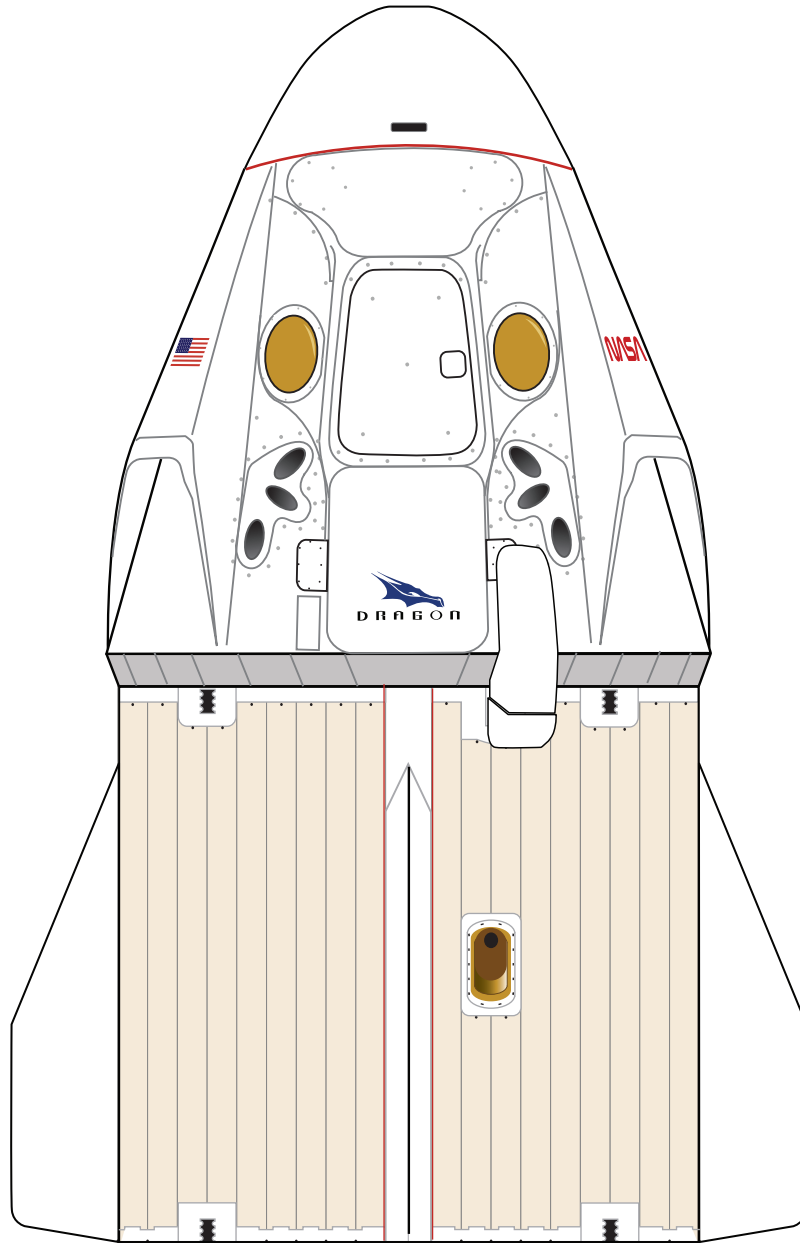

CrewDragon



1:48 Scale





SPACE-X "Crew Dragon 2"

Print on Cardstock (110 lbs)

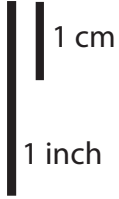

Docking Configuration

1:48 Scale

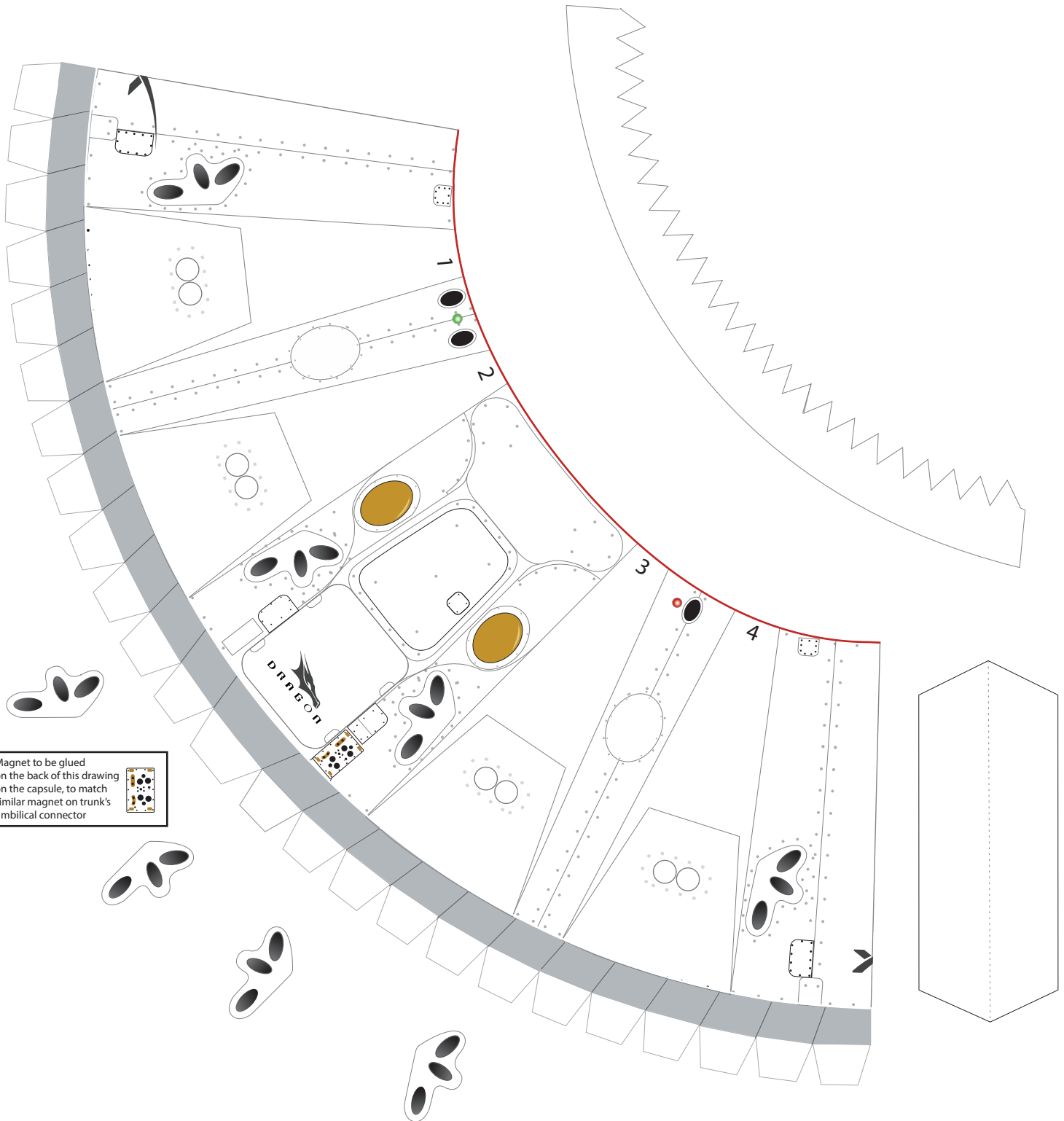

Magnet to be glued on the back of this drawing on the capsule, to match similar magnet on trunk's umbilical connector





SPACE-X "Crew Dragon 2"

Print on Cardstock (110 lbs)



Super Draco Covers

1:48 Scale

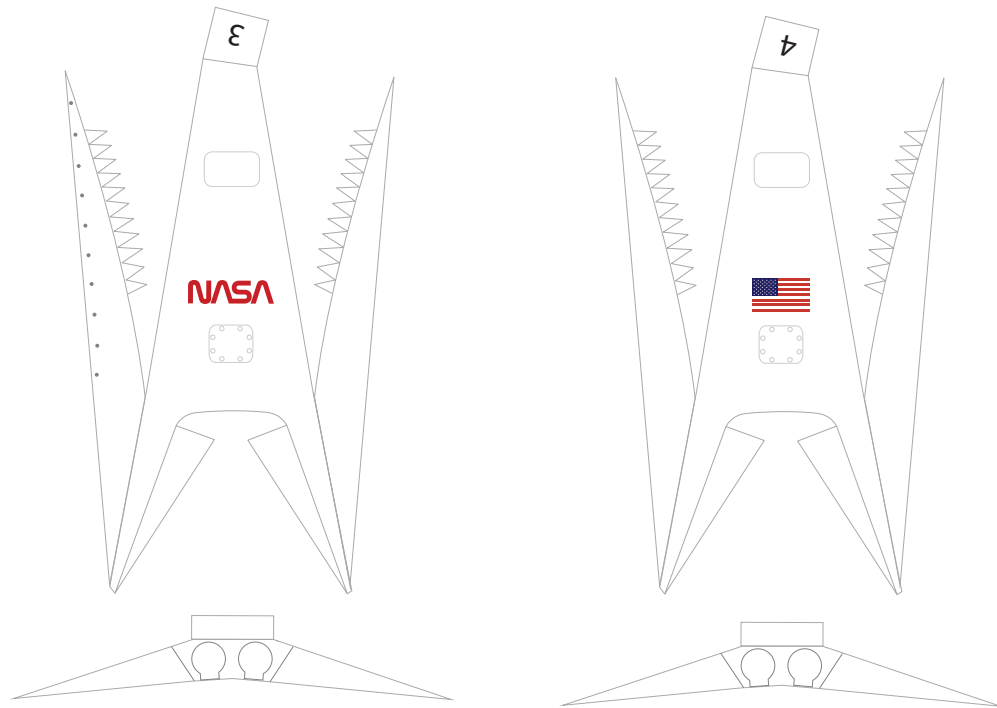
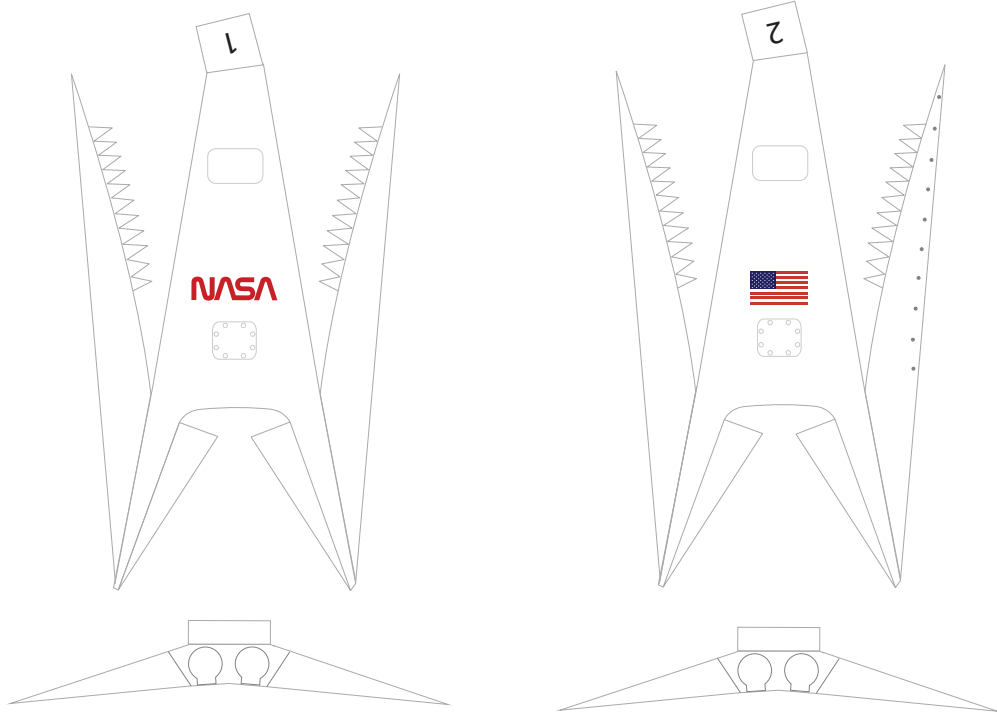



SPACE-X "Crew Dragon 2"

Print on Cardstock (110 lbs)

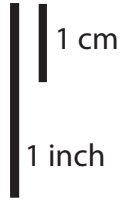

Docking Configuration

1:48 Scale

Heatshield

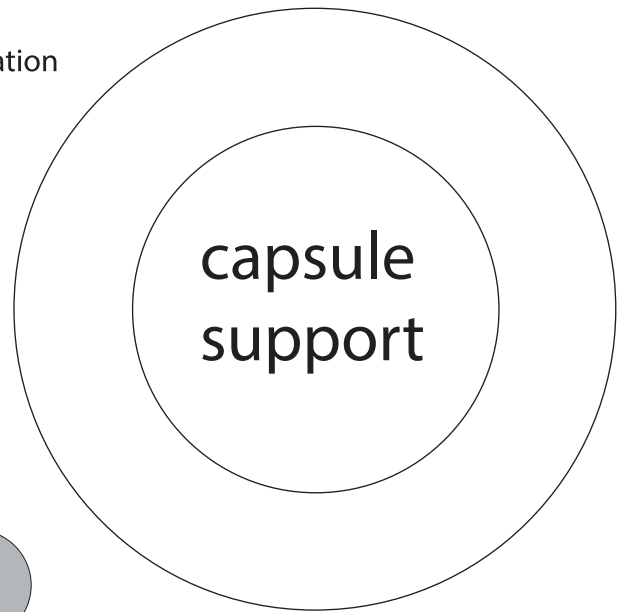
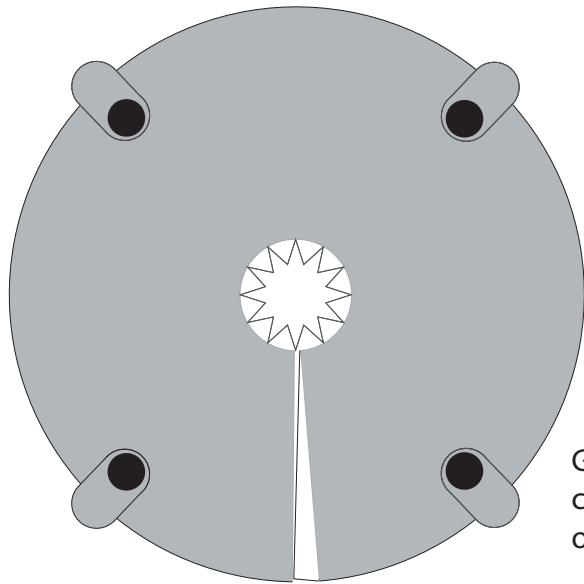

capsule support

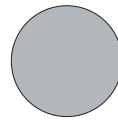

Glue magnet inside capsule in the center of heatshield

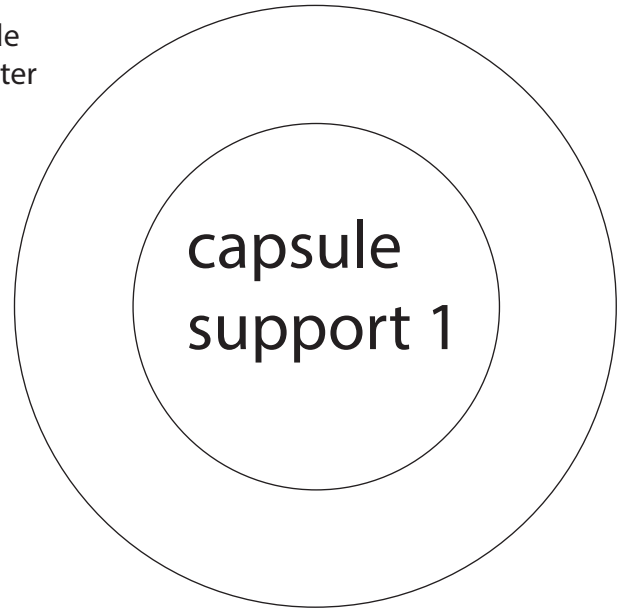

capsule support 1

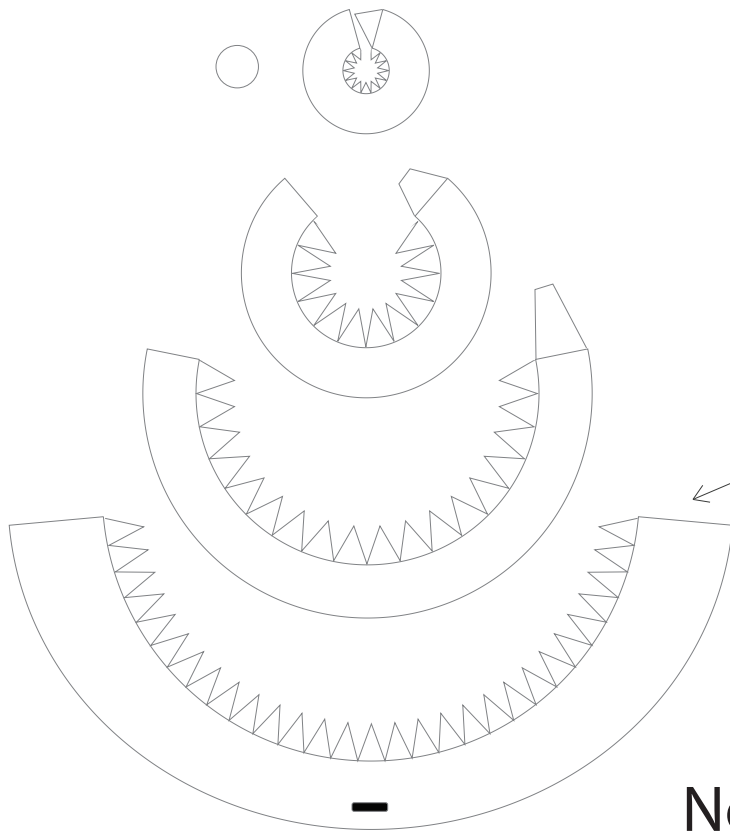

Nosecone



SPACEX "Crew Dragon 2"

Print on Cardstock (110 lbs)

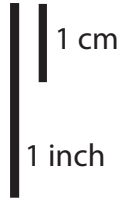

1:48 Scale

Docking Configuration

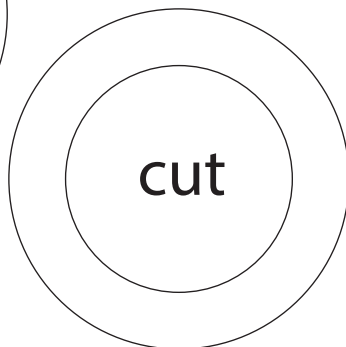
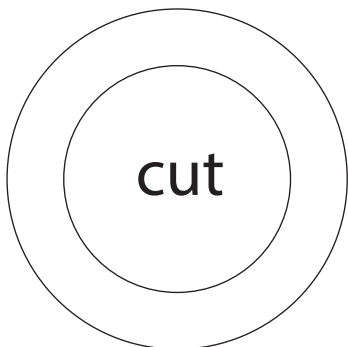
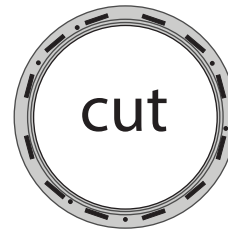
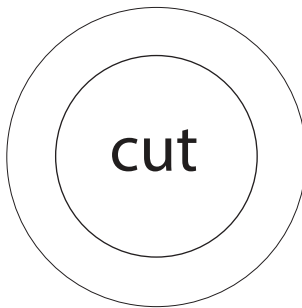
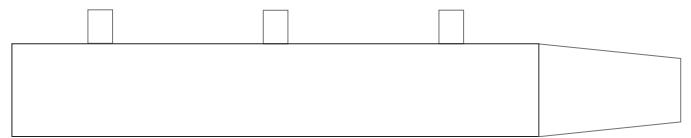
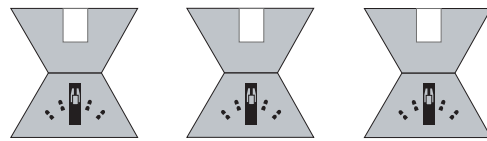
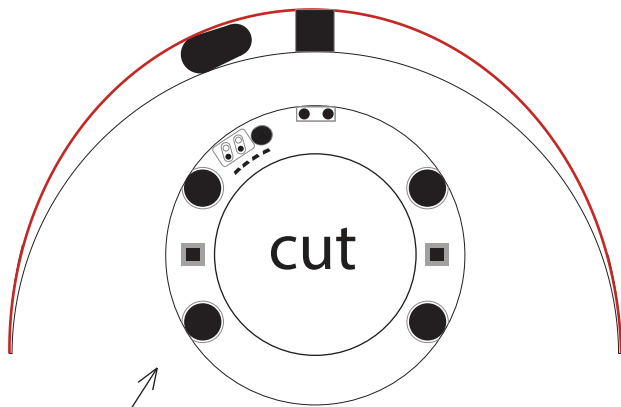
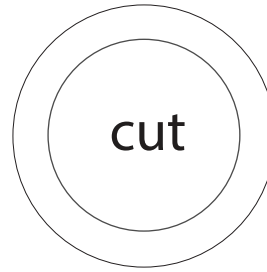
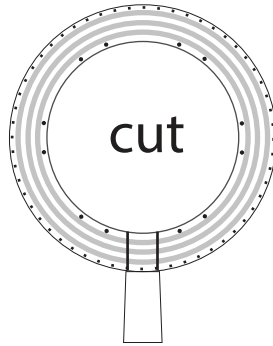
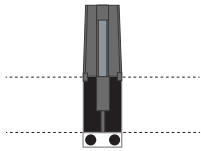

Capsule (top former)

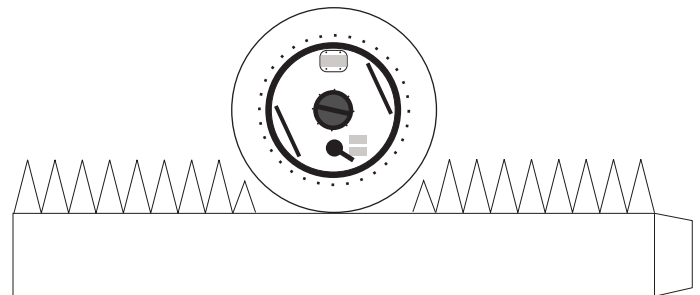

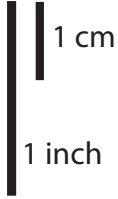

1:48 Scale

Magnet to be glued on the back, to match similar magnet on capsule umbilical area.

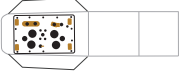

Umbilical

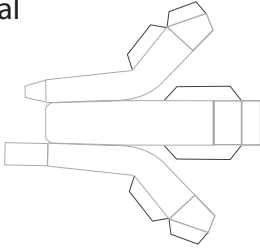

SPACE-X "Crew Dragon 2"

Trunk

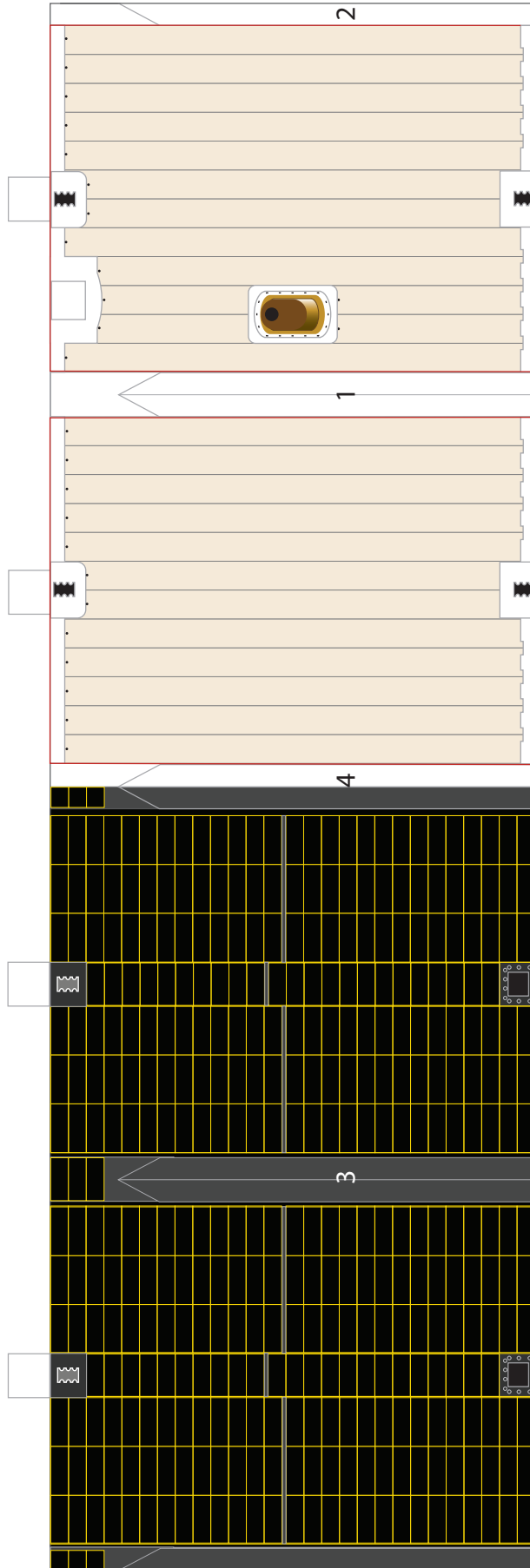

cut

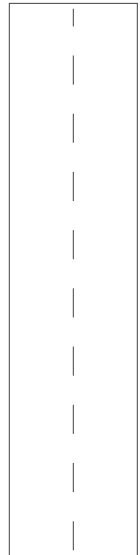



Trunk Fins

1:48 Scale

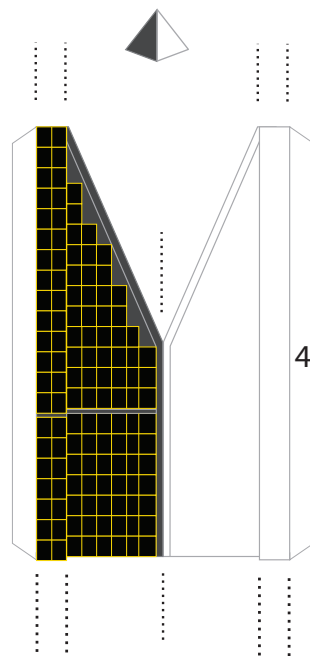
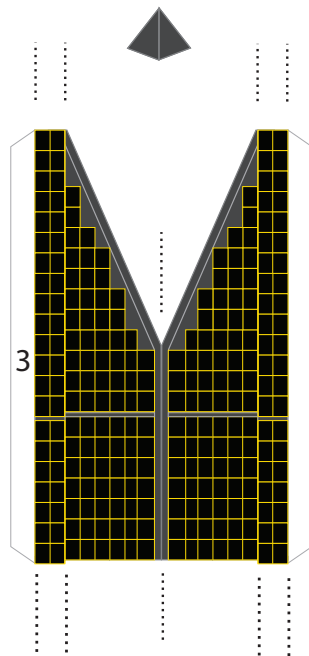
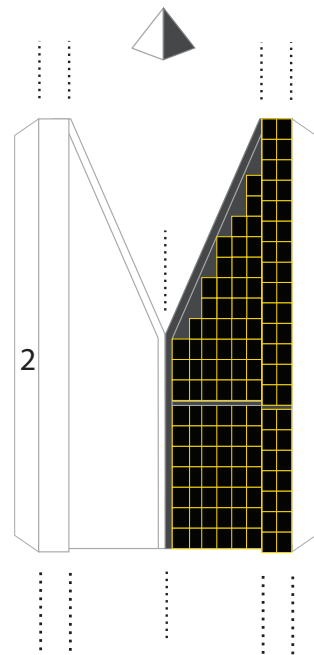
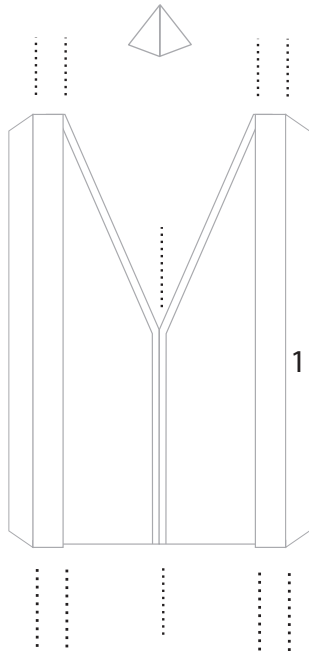

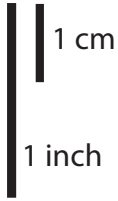

1:48 Scale

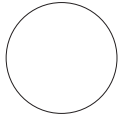

Glue magnet between circles

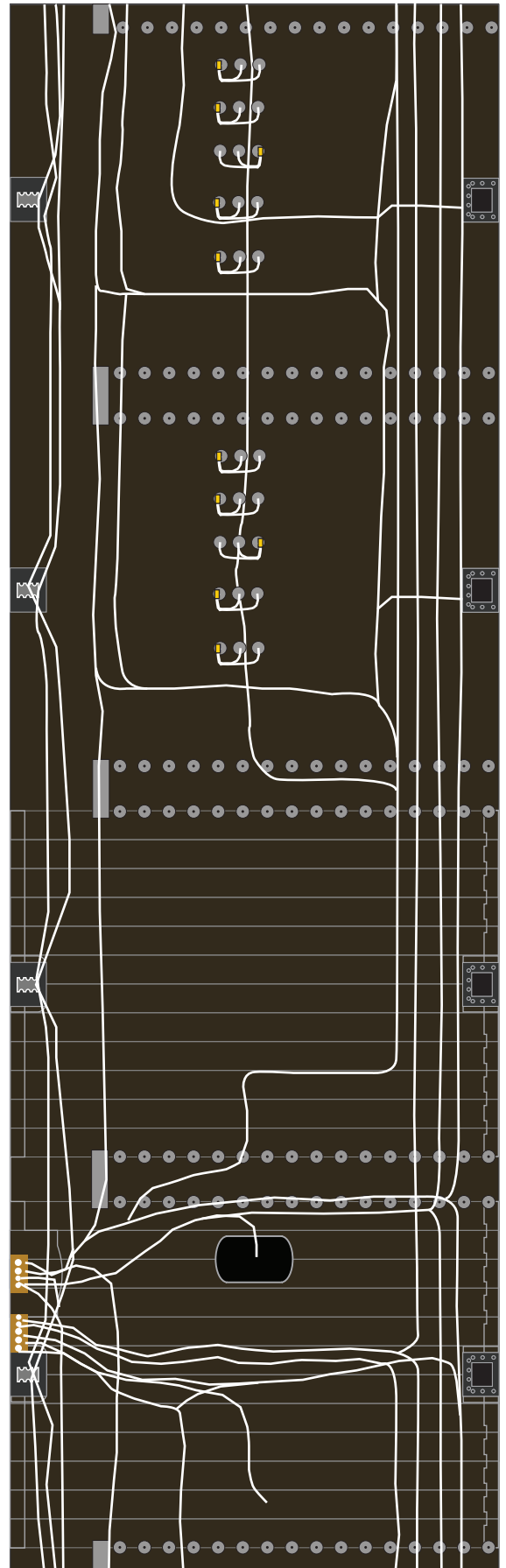
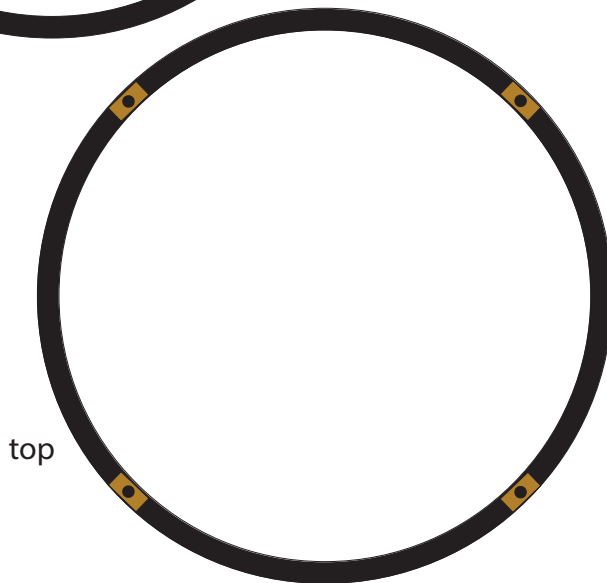
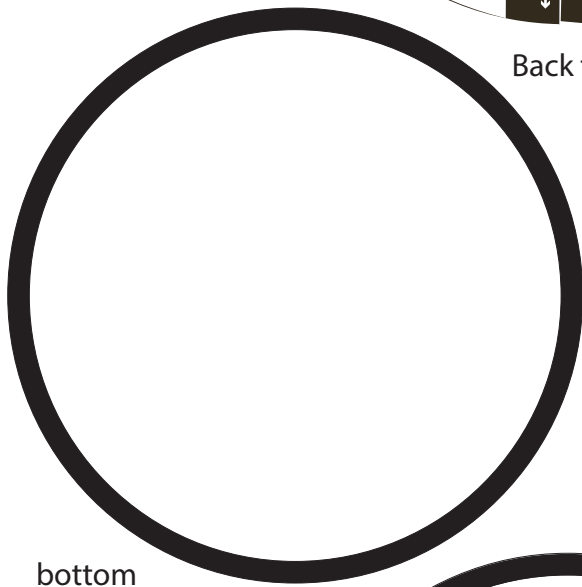
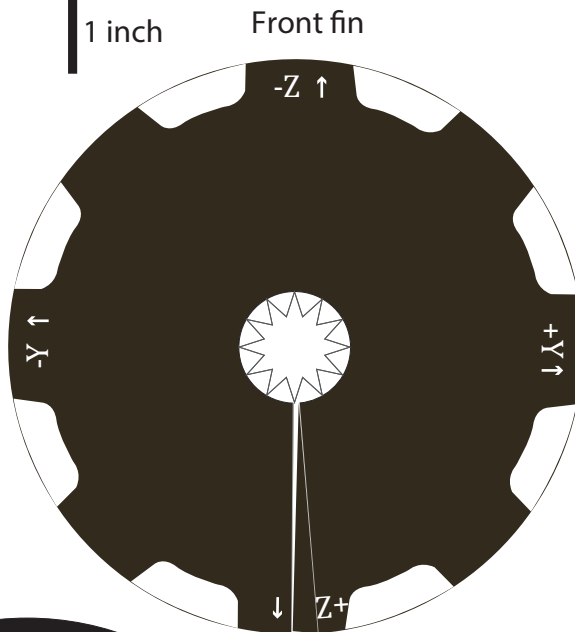

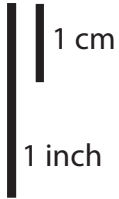

CrewDragon 2 Display Base

1:48 Scale

Dragon v2 Base

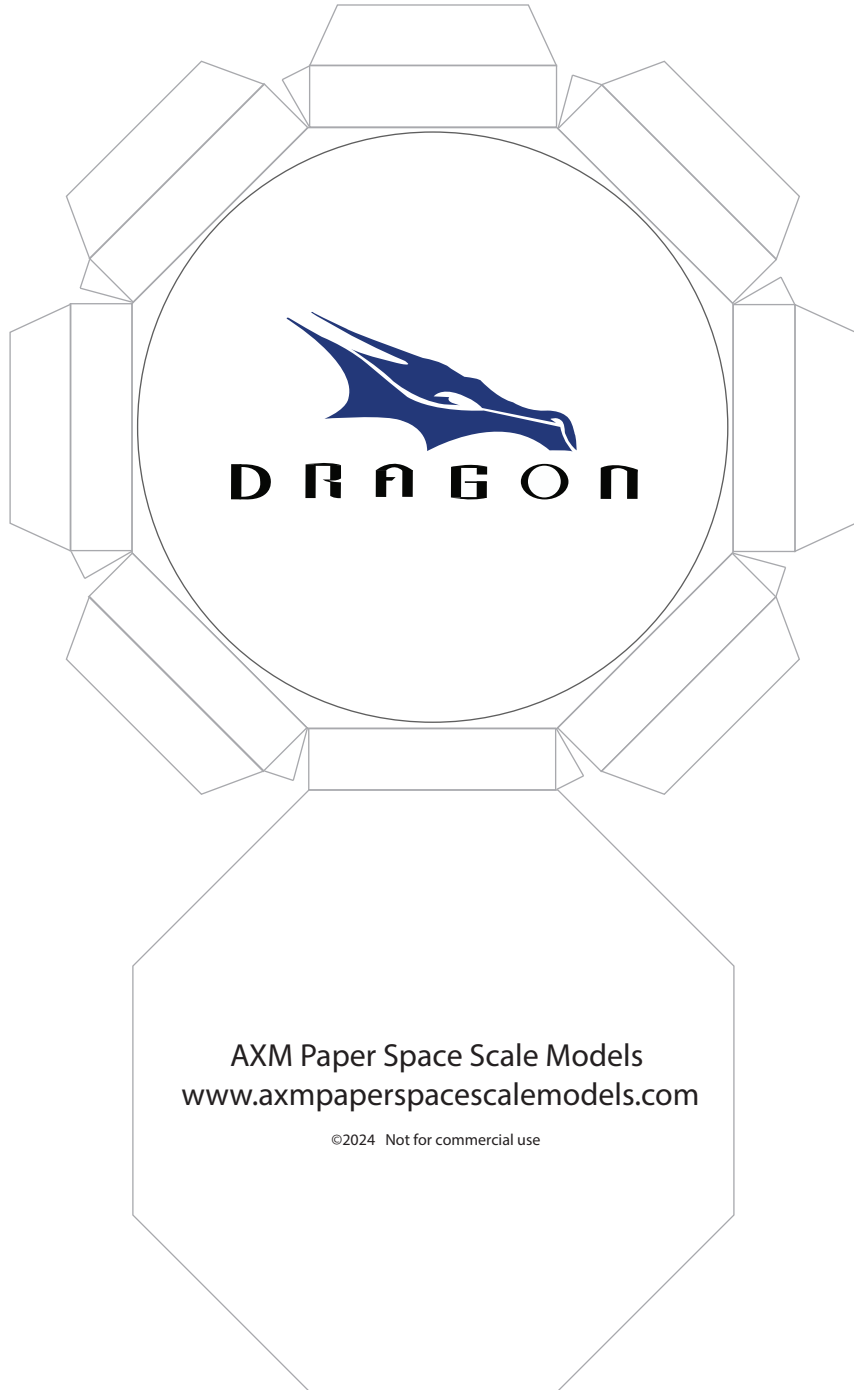

Print on Cardstock (110 lbs)