



1 cm
1 inch

SPACE-X "Crew Dragon 2" Polaris Dawn Capsule Launch Configuration

Print on Cardstock (90 lbs)

1:100 Scale

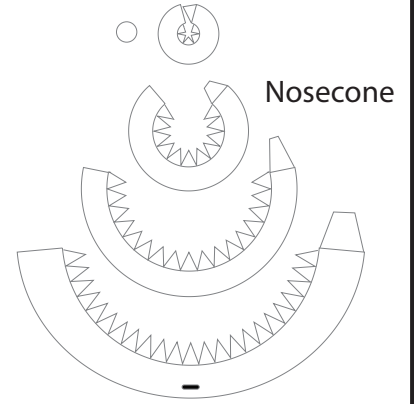

Nosecone

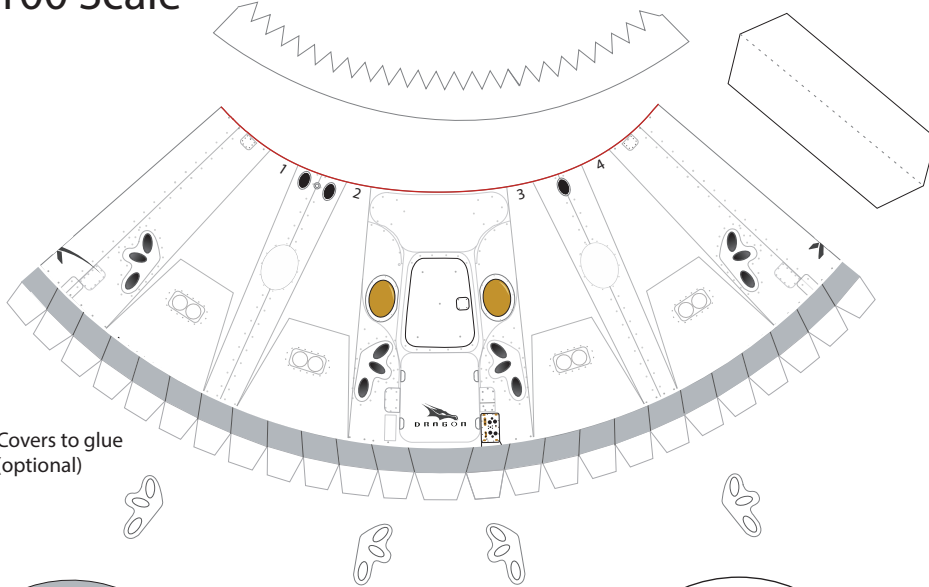

Nozzle Covers to glue on top (optional)

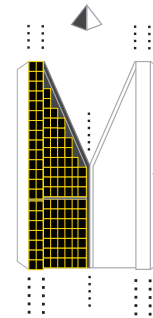
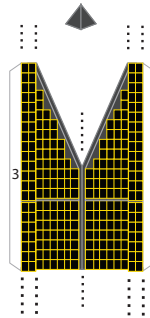
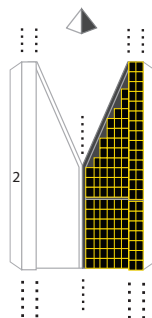
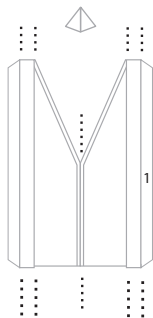
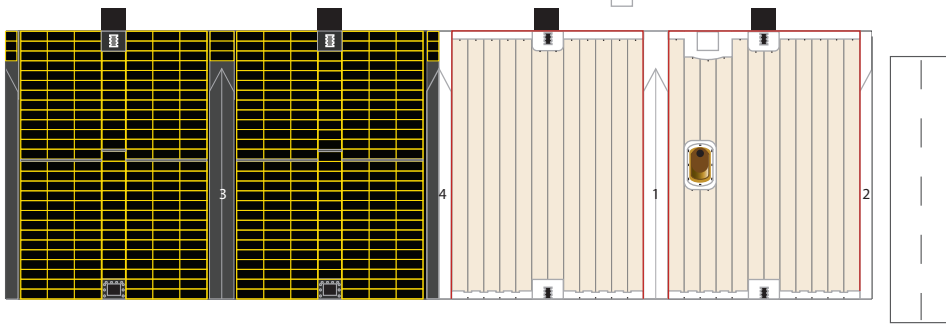
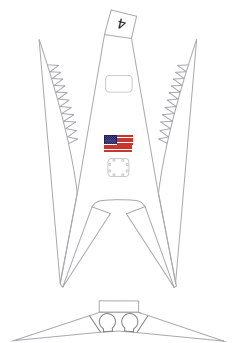
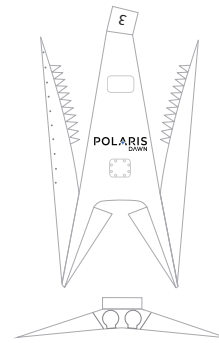
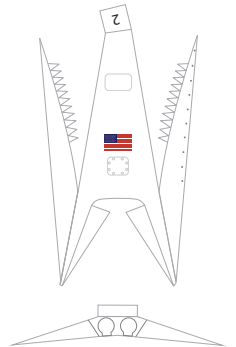
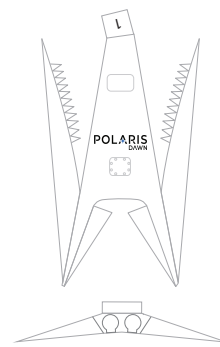
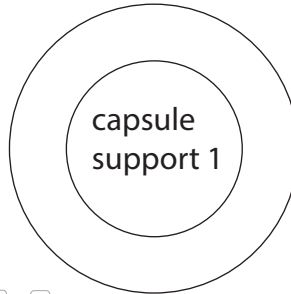
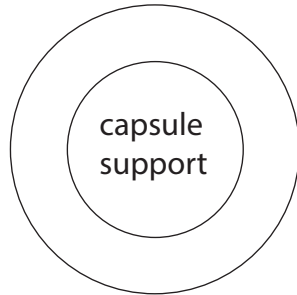
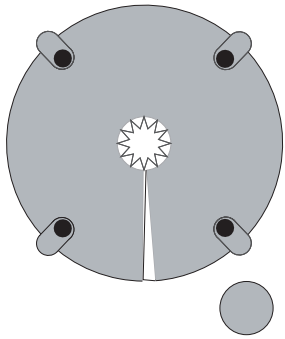



SPACE-X "Falcon 9 Block 5"

Print on Cardstock (110 lbs)

1 cm

Polaris Dawn

1 inch

Crew Dragon 2 connector

1:100 Scale



FALCON 9

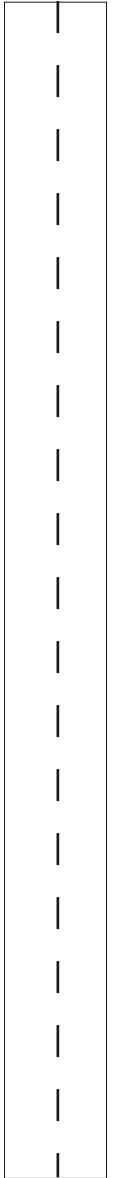
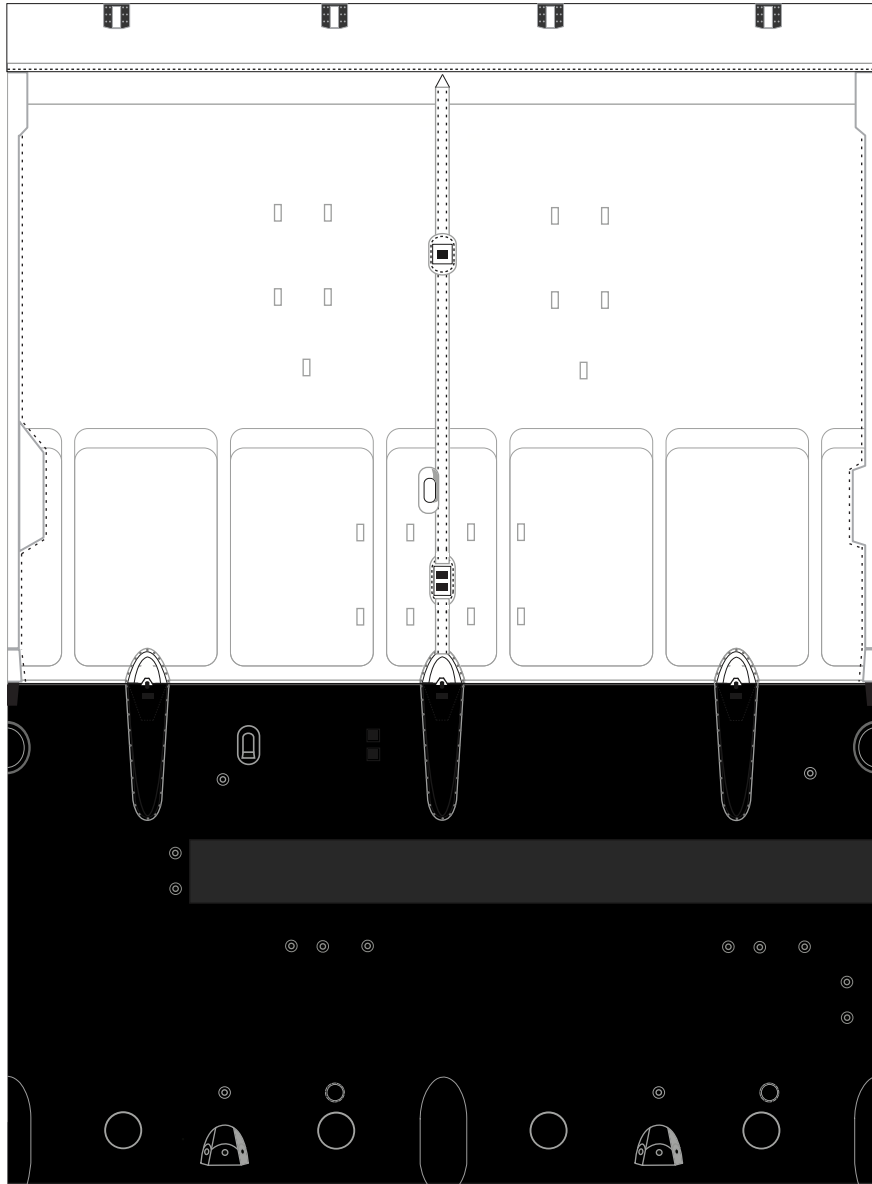
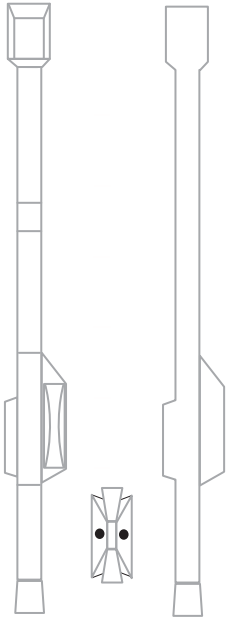

Titanium Grid Fins

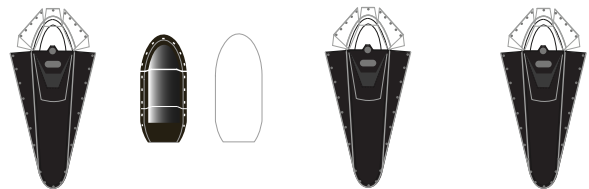
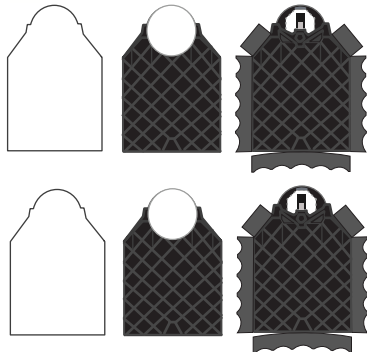
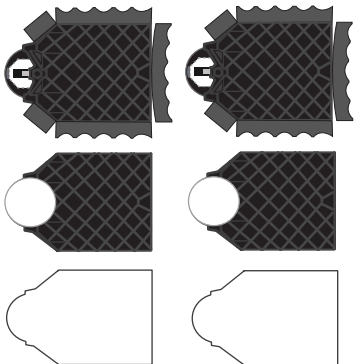



1:100 Scale

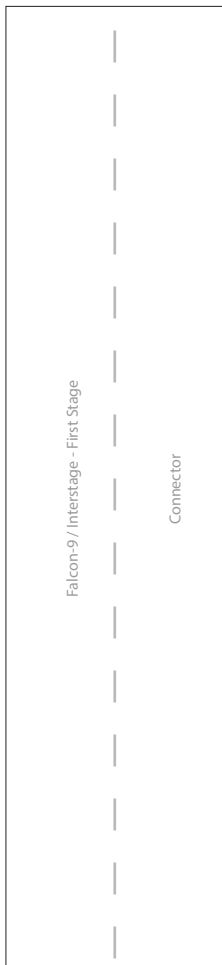

SPACE-X "Falcon 9 Block 5"

Print on Cardstock (110 lbs)
Polaris Dawn **Block 5**

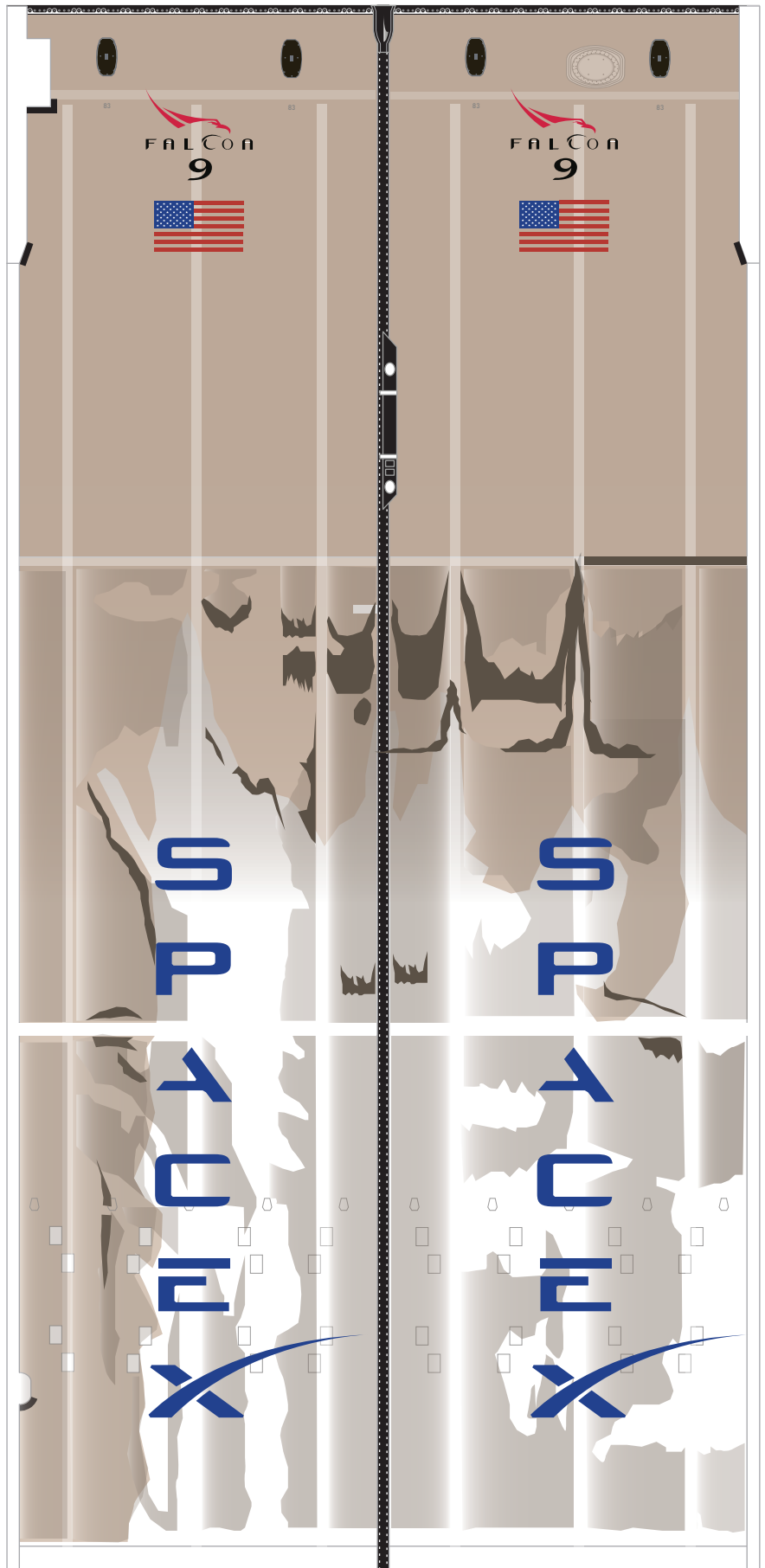



1:100 Scale



SPACE-X "Falcon 9 Block 5"

Print on Cardstock (110 lbs)



Polaris Dawn

Block 5

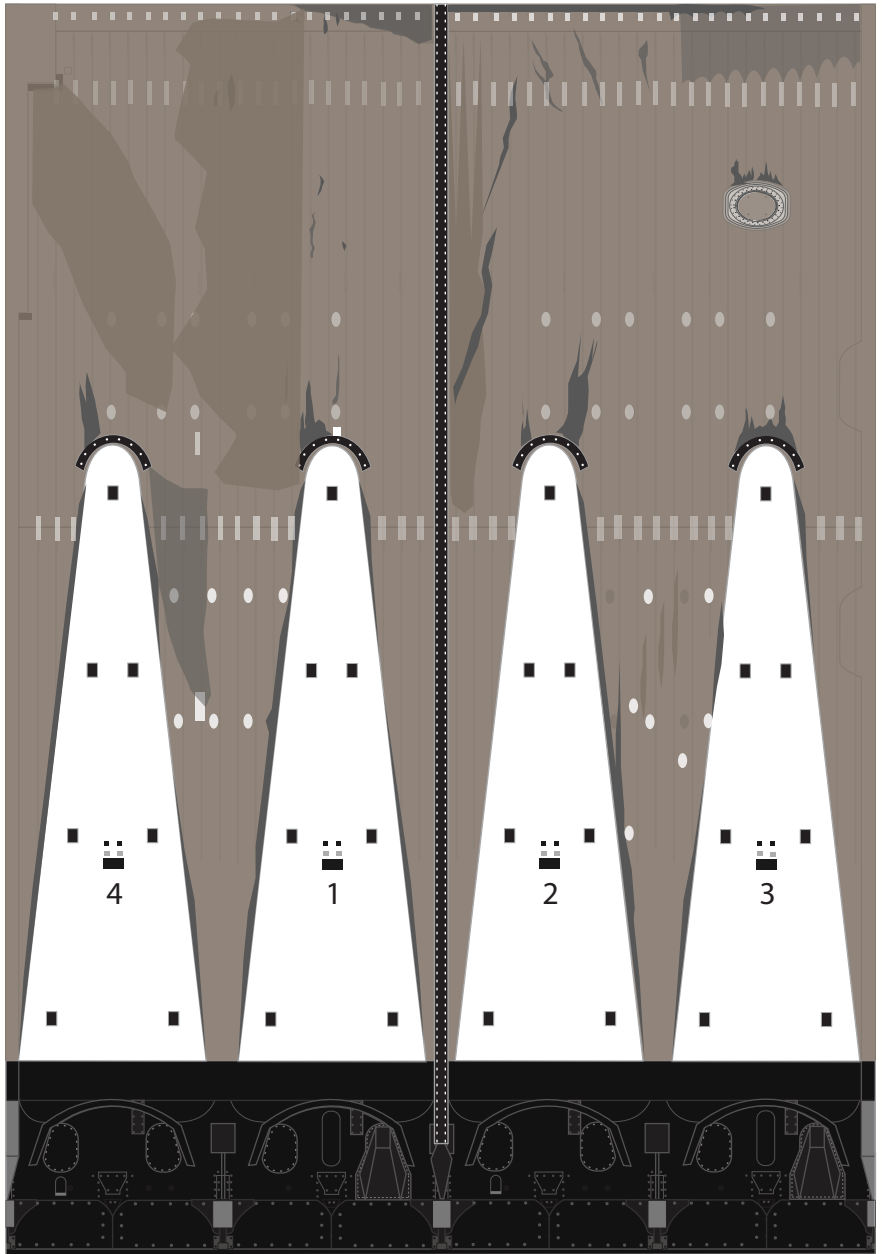
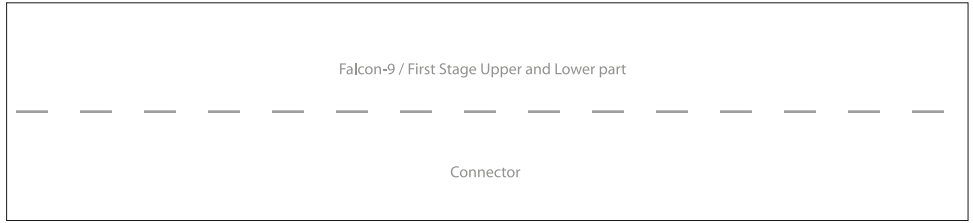



1:100 Scale



SPACE-X "Falcon 9 Block 5"

Print on Cardstock (110 lbs)

BLOCK 5

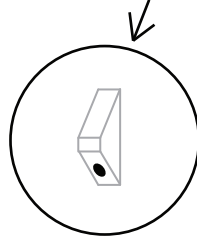

Thicker Raceway



bottom



1:100 Scale

SPACE-X "Falcon-9 Block 5"

Print on Cardstock (110 lbs)

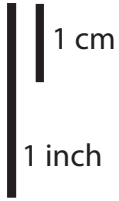

LEGS 2.0

SSO-A

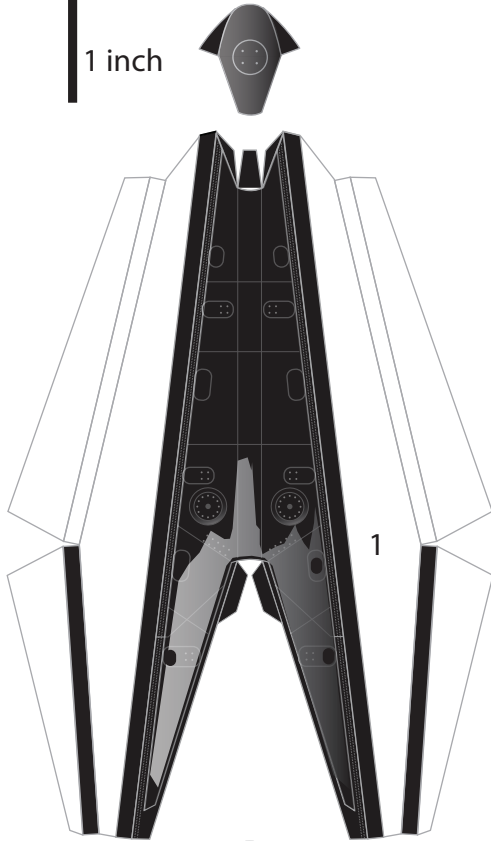

1

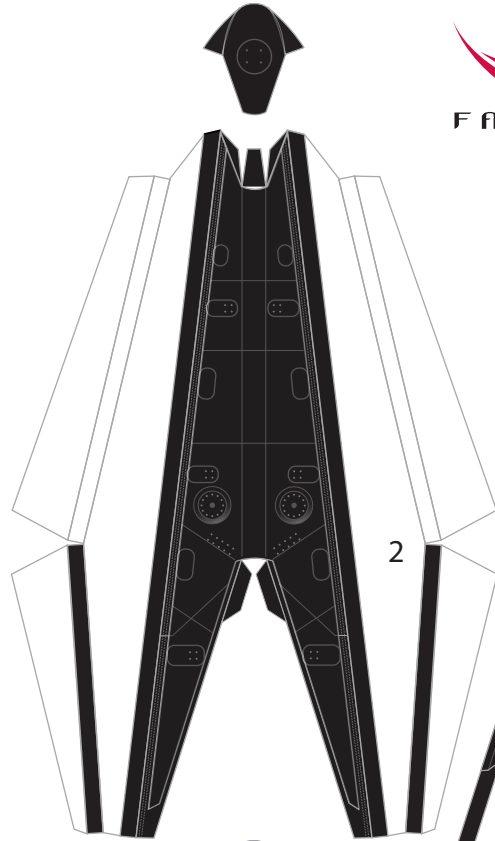

2

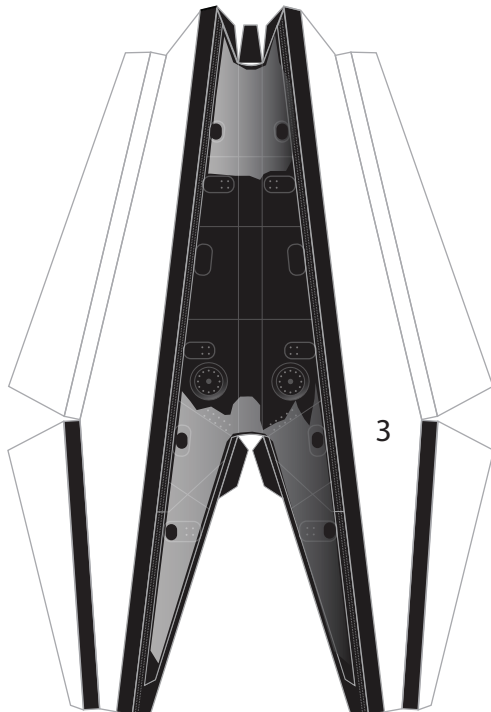
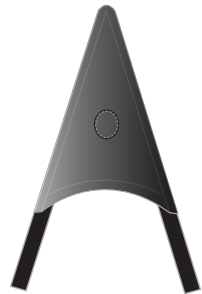

3

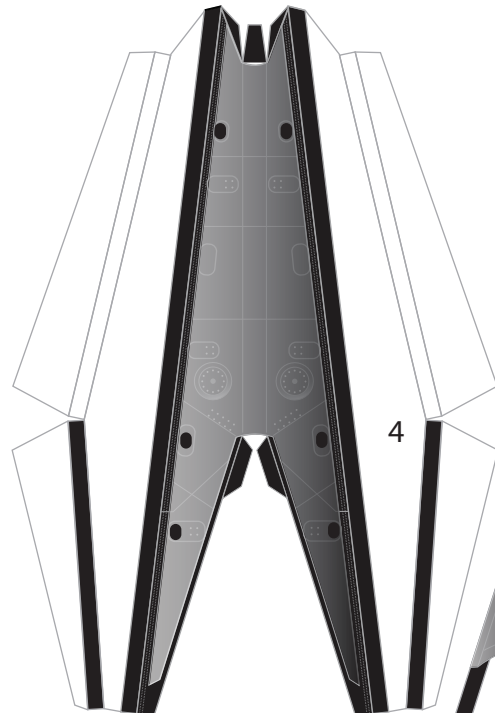

4

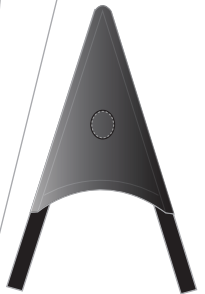



SPACE-X "Falcon 9 Block 5"

Print on Cardstock (110 lbs)



LEGS 2.0 page 2

Rev. 2



1:100 Scale

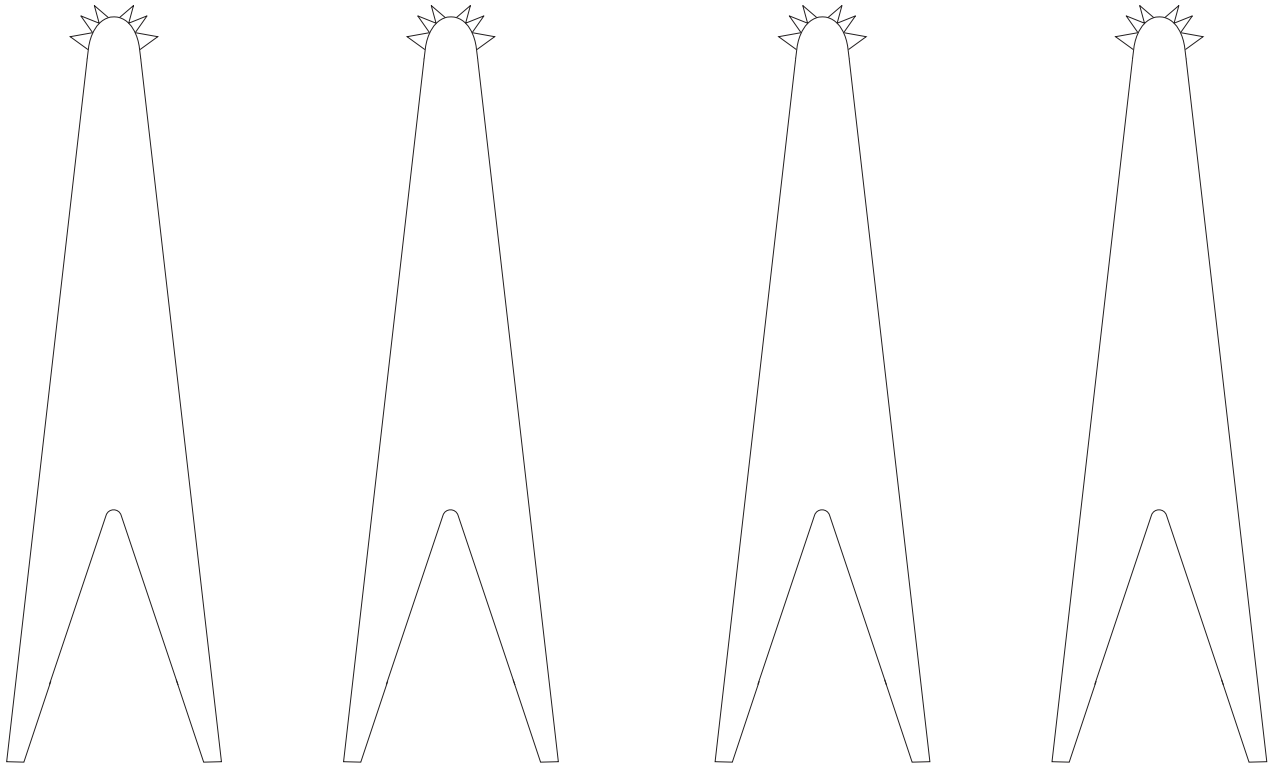

Legs pins

(roll the complete strip and then cut the individual pieces)

New Leg Hinges

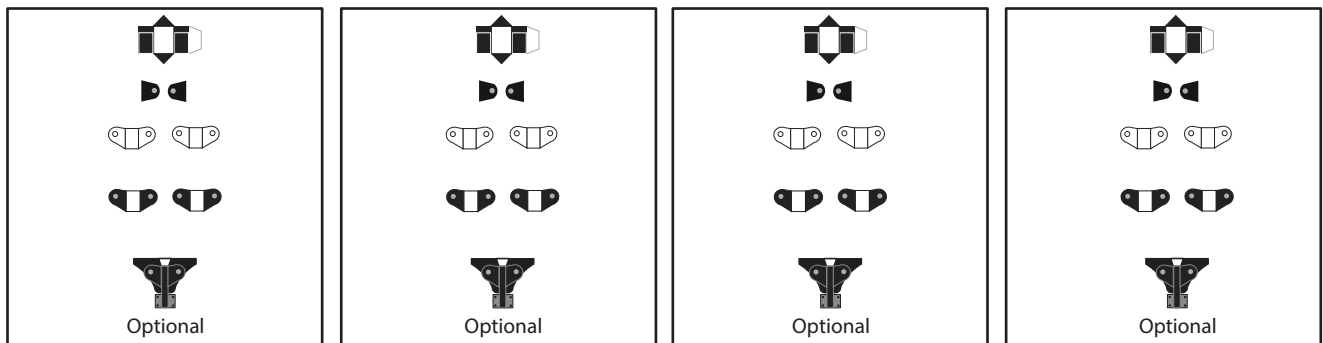

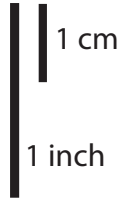

SPACE-X Falcon 9 Octaweb

Print on Cardstock (110 lbs)

MERLIN Engines

1:100 Scale

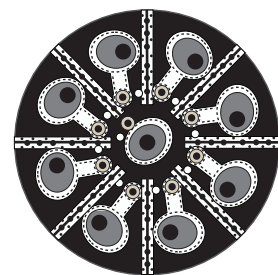
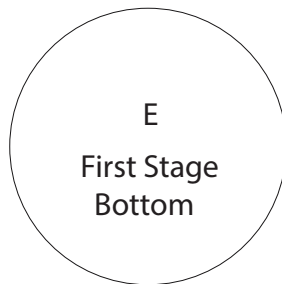
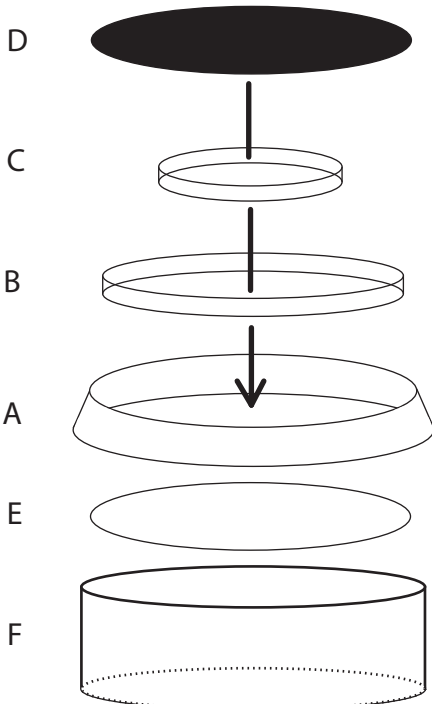
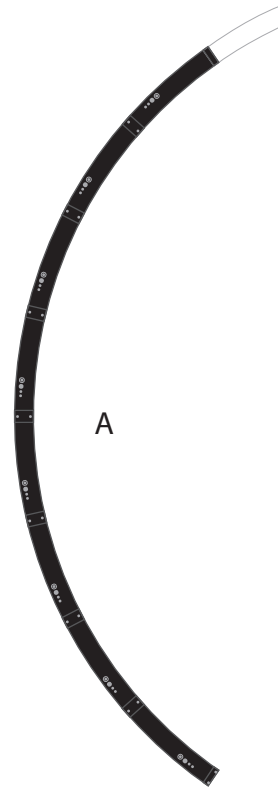
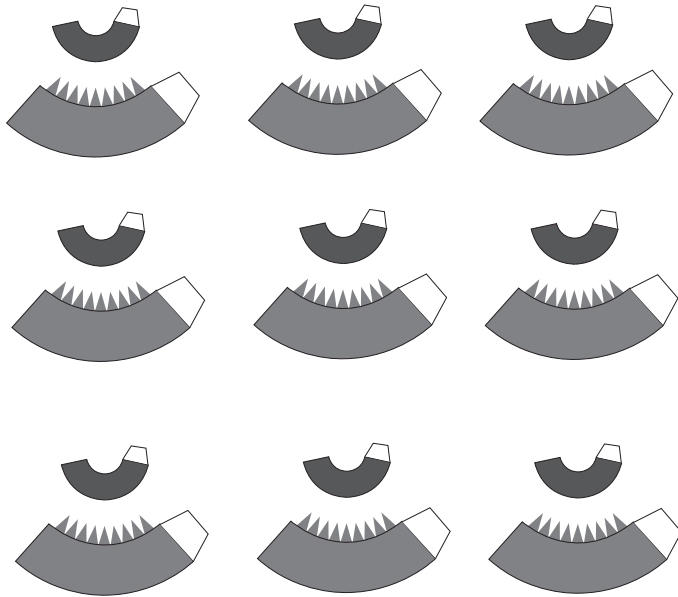

Engine Grid
OCTAWEB

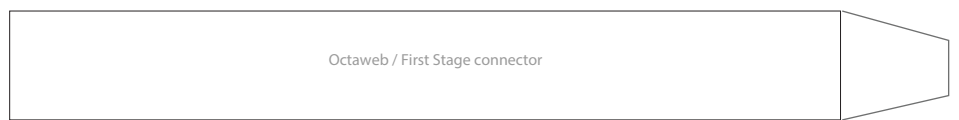



1:100 Scale



SPACE-X "Falcon 9" Octaweb

Print on Cardstock (110 lbs)

MERLIN Engines

BACK PRINT

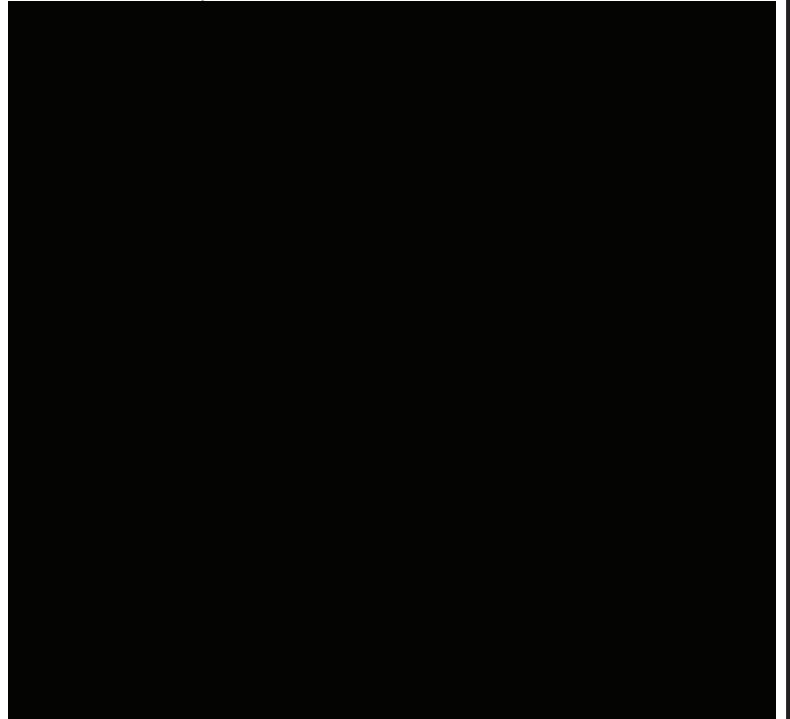

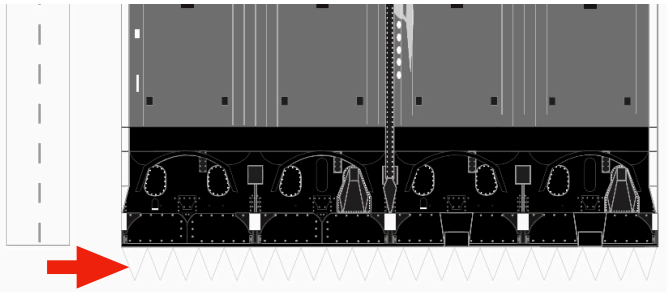

Remove the triangular tabs from the bottom of the First Stage of a Falcon 9

