

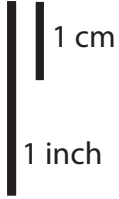

SPACE-X "Crew Dragon 2"

Print on Cardstock (110 lbs)



POLARIS DAWN

1:48 Scale

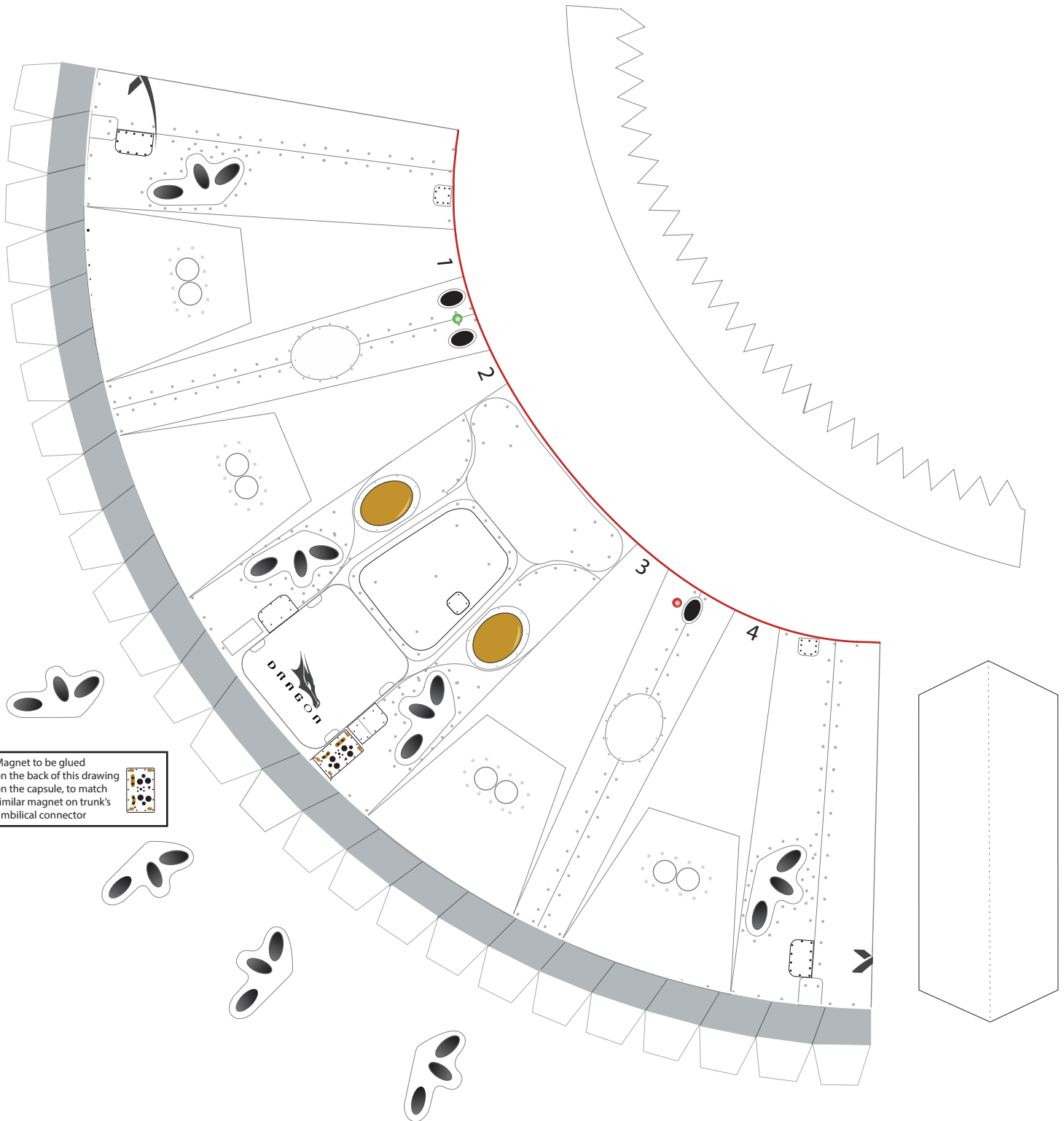

Magnet to be glued on the back of this drawing on the capsule, to match similar magnet on trunk's umbilical connector





SPACE-X "Crew Dragon 2"

Print on Cardstock (110 lbs)

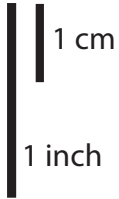

Super Draco Covers

1:48 Scale

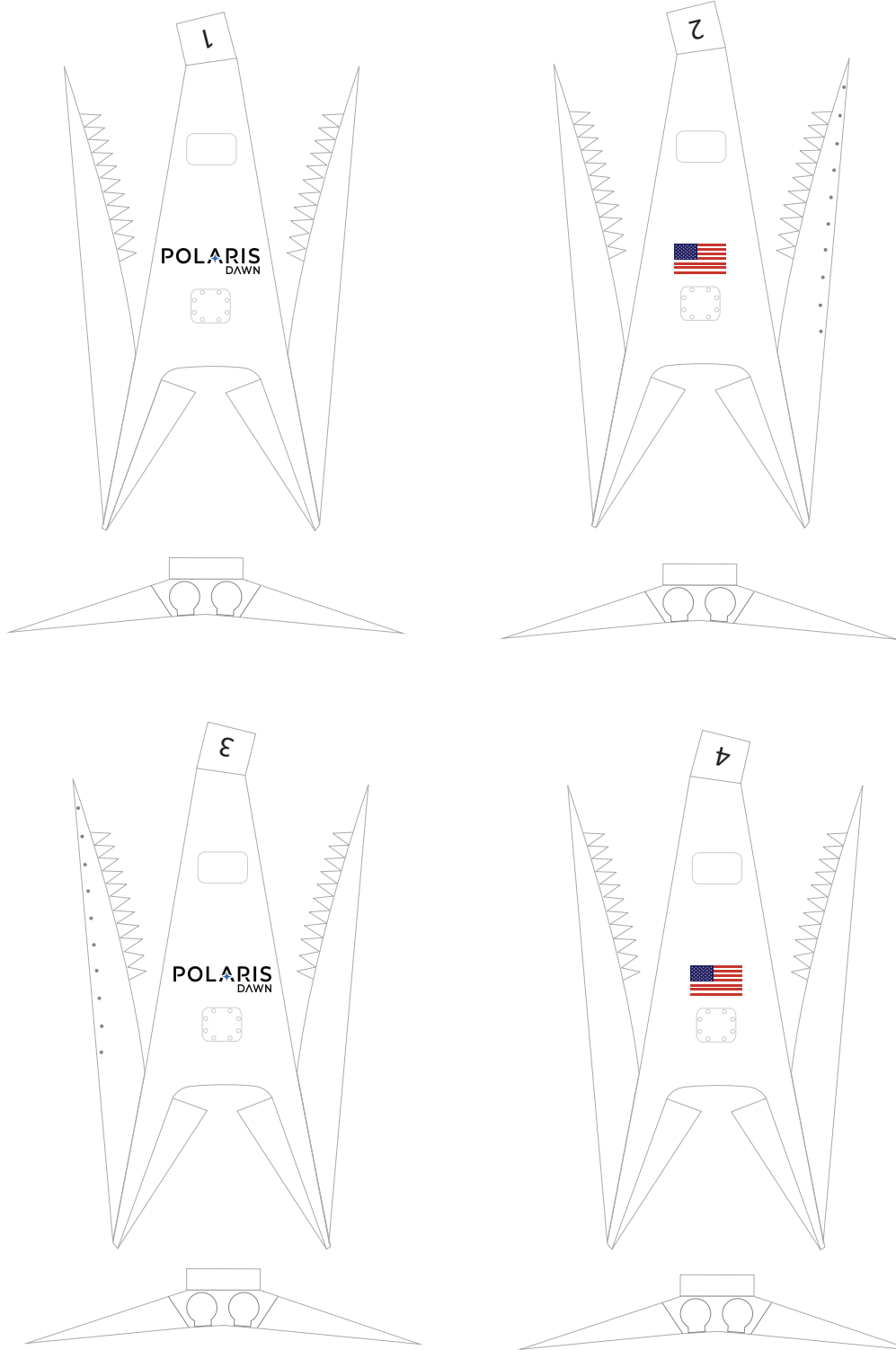



SPACE-X "Crew Dragon 2"

Print on Cardstock (110 lbs)



Docking Configuration

1:48 Scale

Heatshield

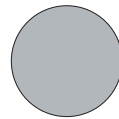
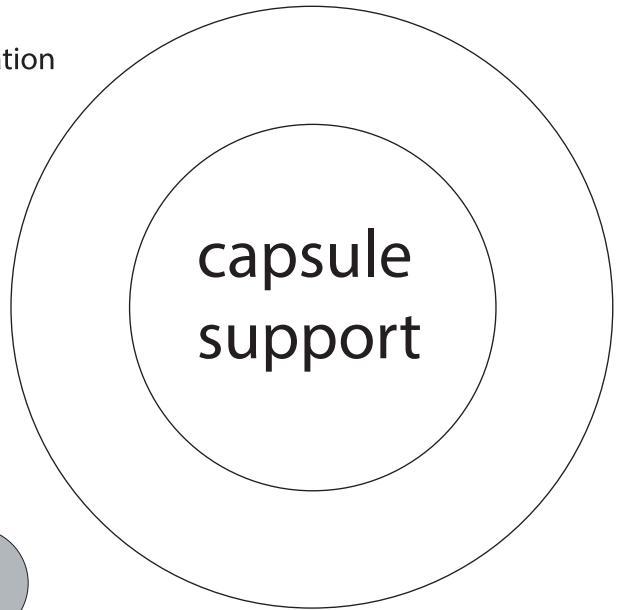
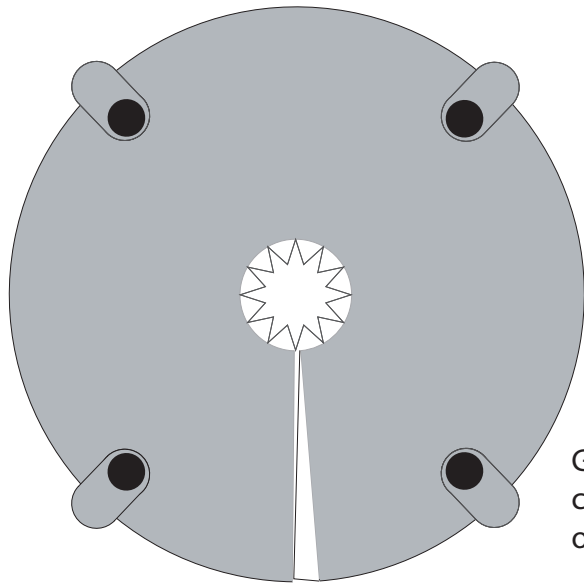

Glue magnet inside capsule in the center of heatshield

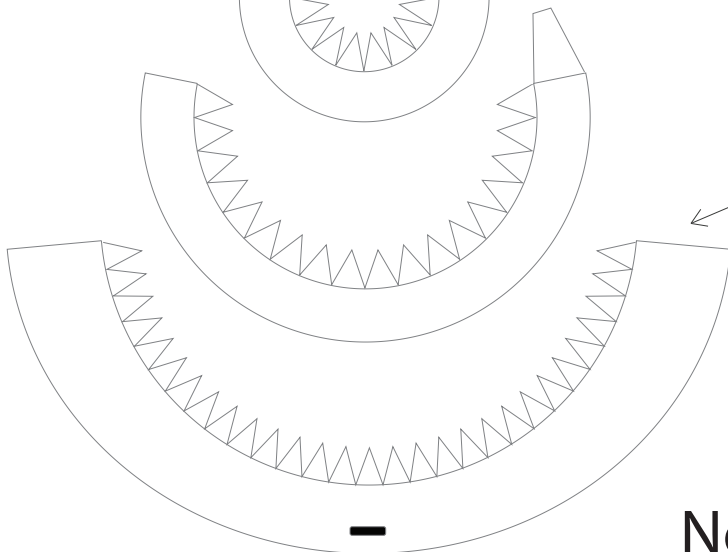
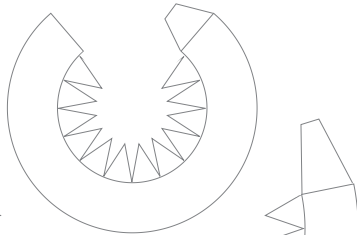
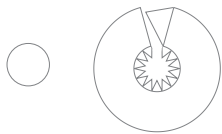
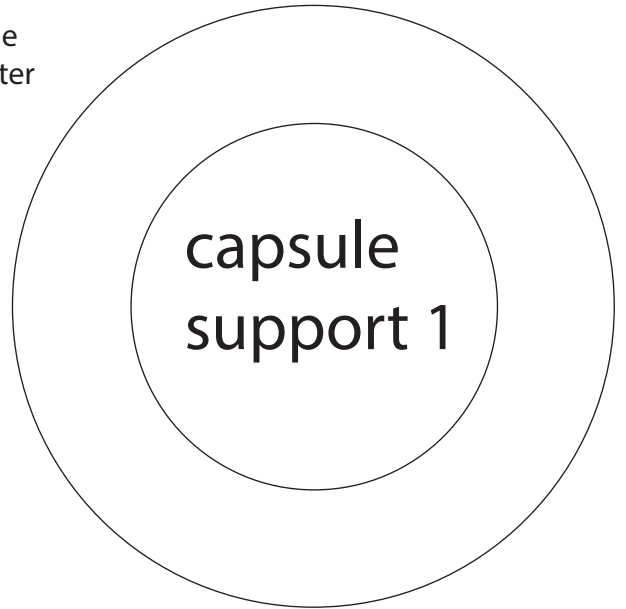

Nosecone



SPACEX "Crew Dragon 2"

Print on Cardstock (110 lbs)

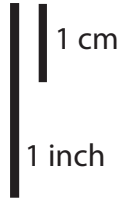

1:48 Scale

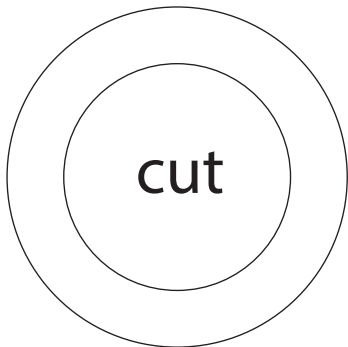
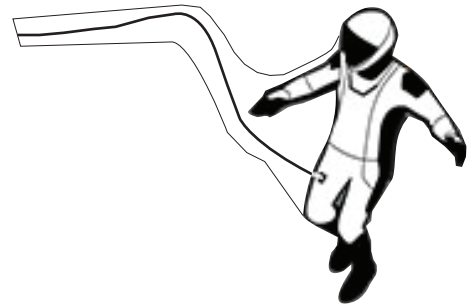
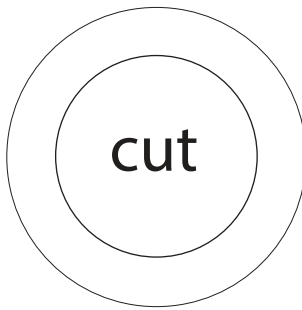
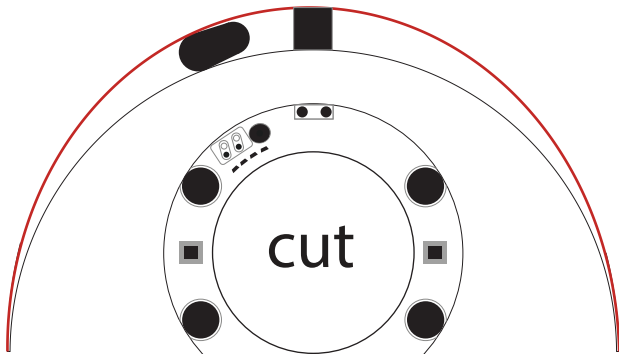
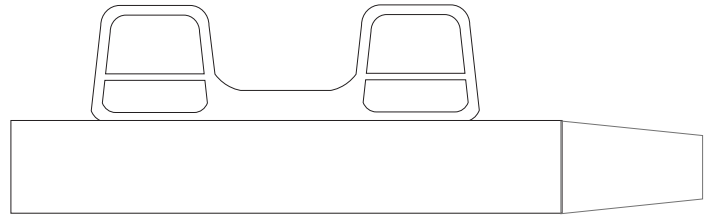
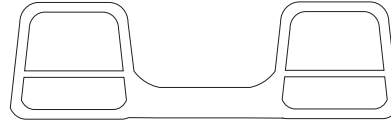
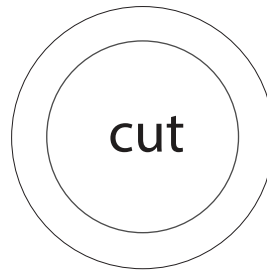
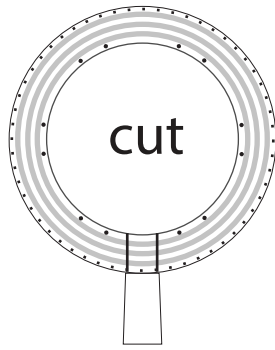
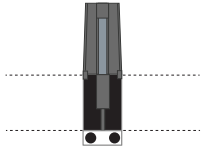

Capsule (top former)

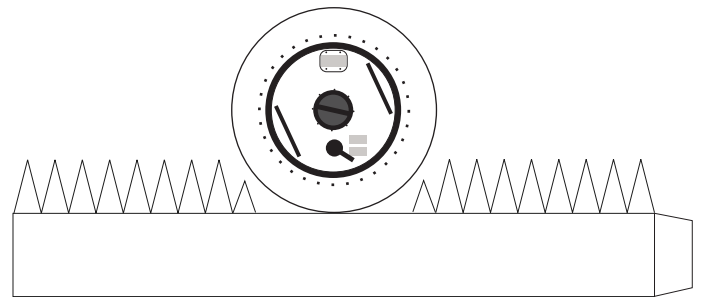
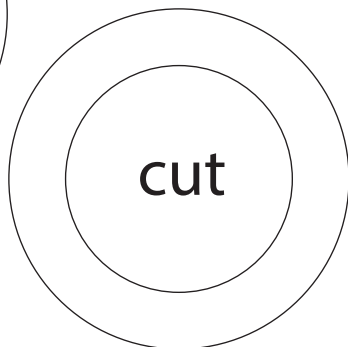

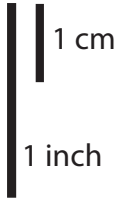

1:48 Scale

Magnet to be glued on the back, to match similar magnet on capsule umbilical area.

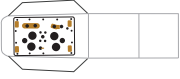

Umbilical

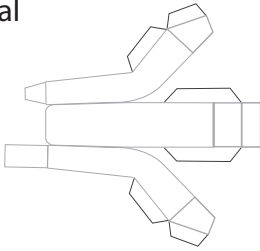

SPACE-X "Crew Dragon 2"

Trunk

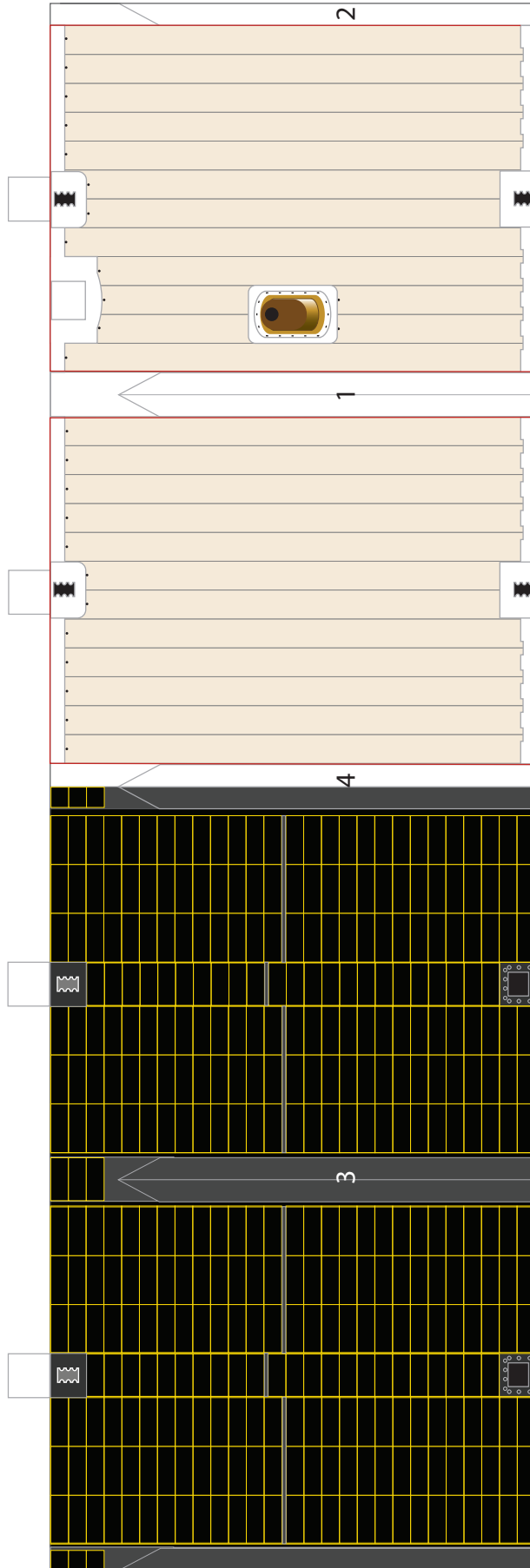

cut

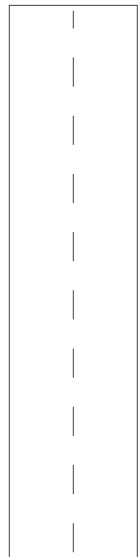



Trunk Fins

1:48 Scale

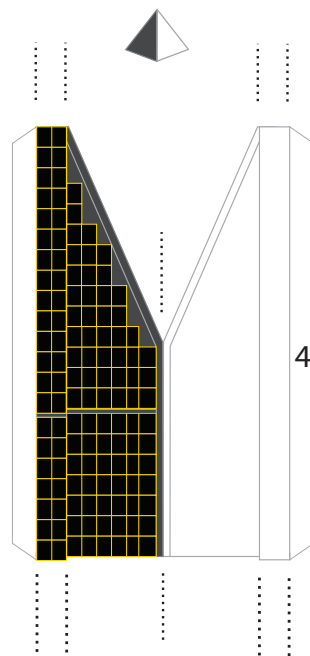
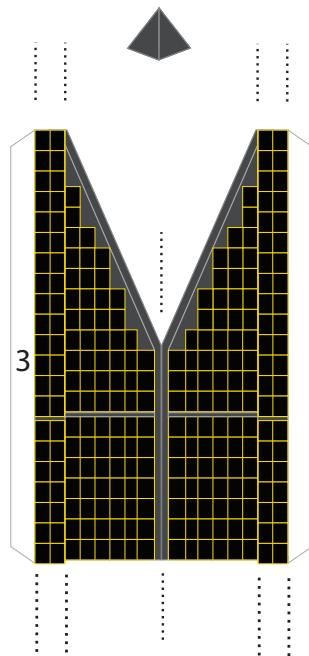
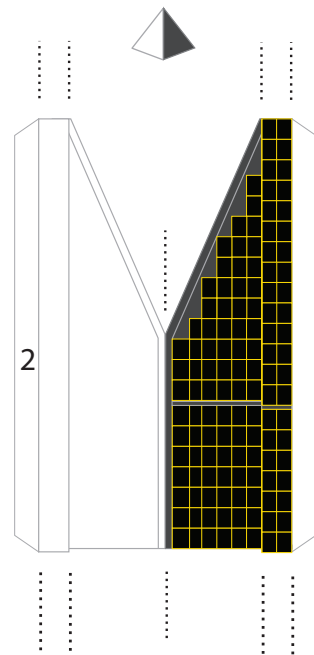
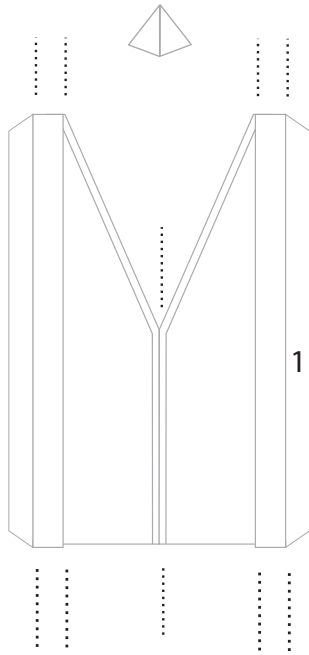



1:48 Scale

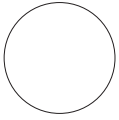

Glue magnet between circles

