

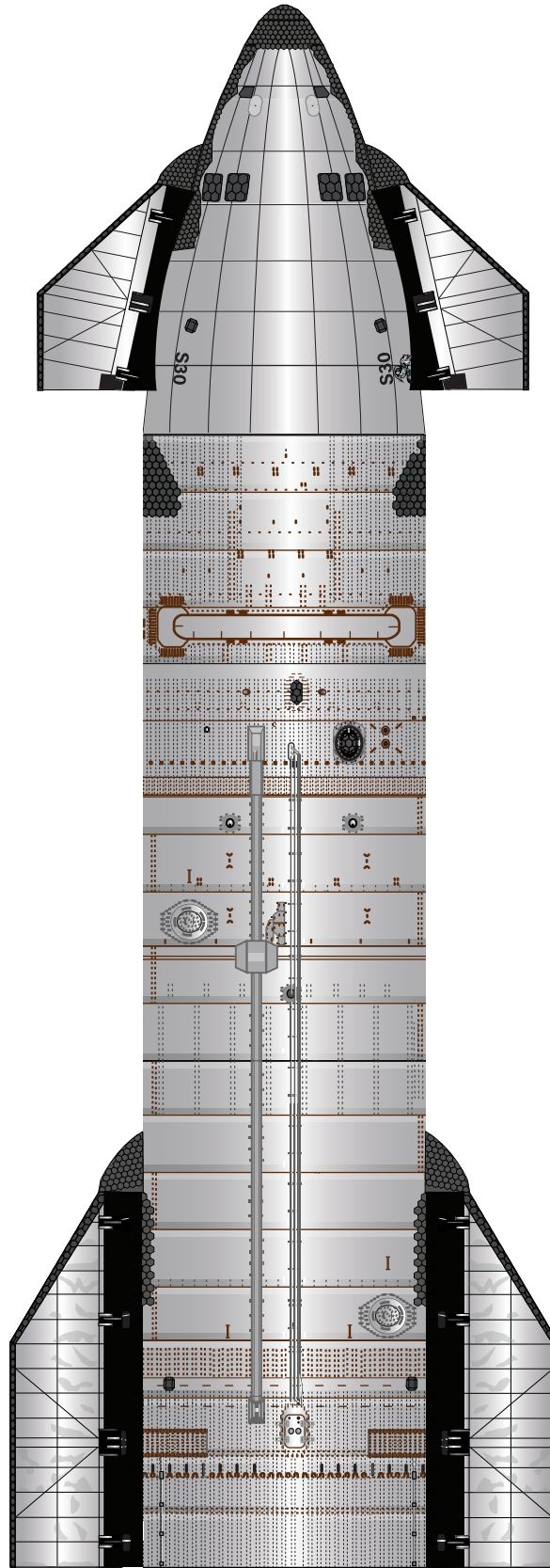

1:100 Scale



S30

S
T
A
R
S
H
I
P

Designed by Alfonso X Moreno
©2024 Not for commercial use



SpaceX Starship S30

Print on Cardstock (110 lbs)

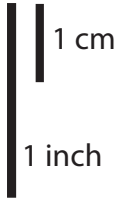

1:100 Scale

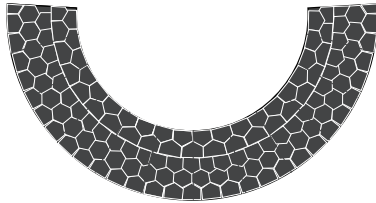

ring 7

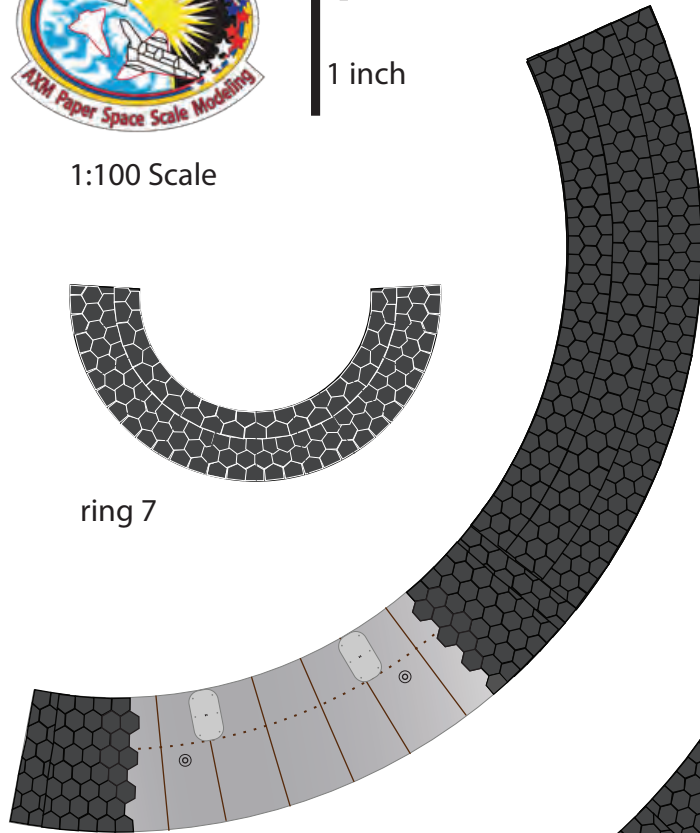

ring 5

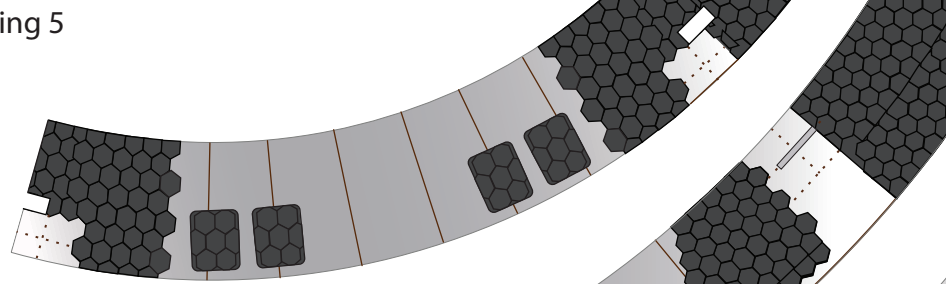

ring 4

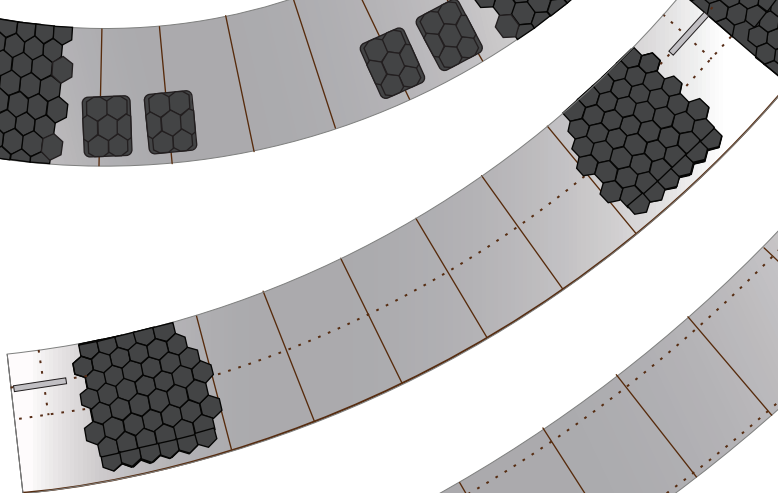

ring 3

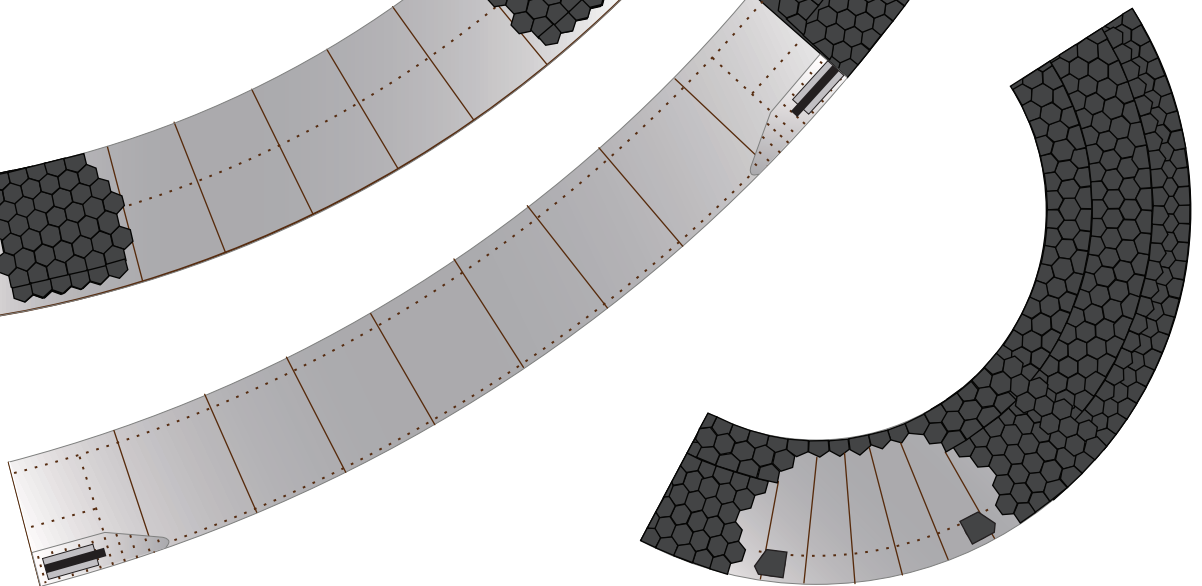

ring 2



ring 9



ring 8

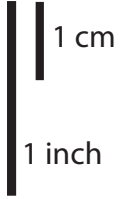

SpaceX Starship S30

Print on Cardstock (110 lbs)

1:100 Scale

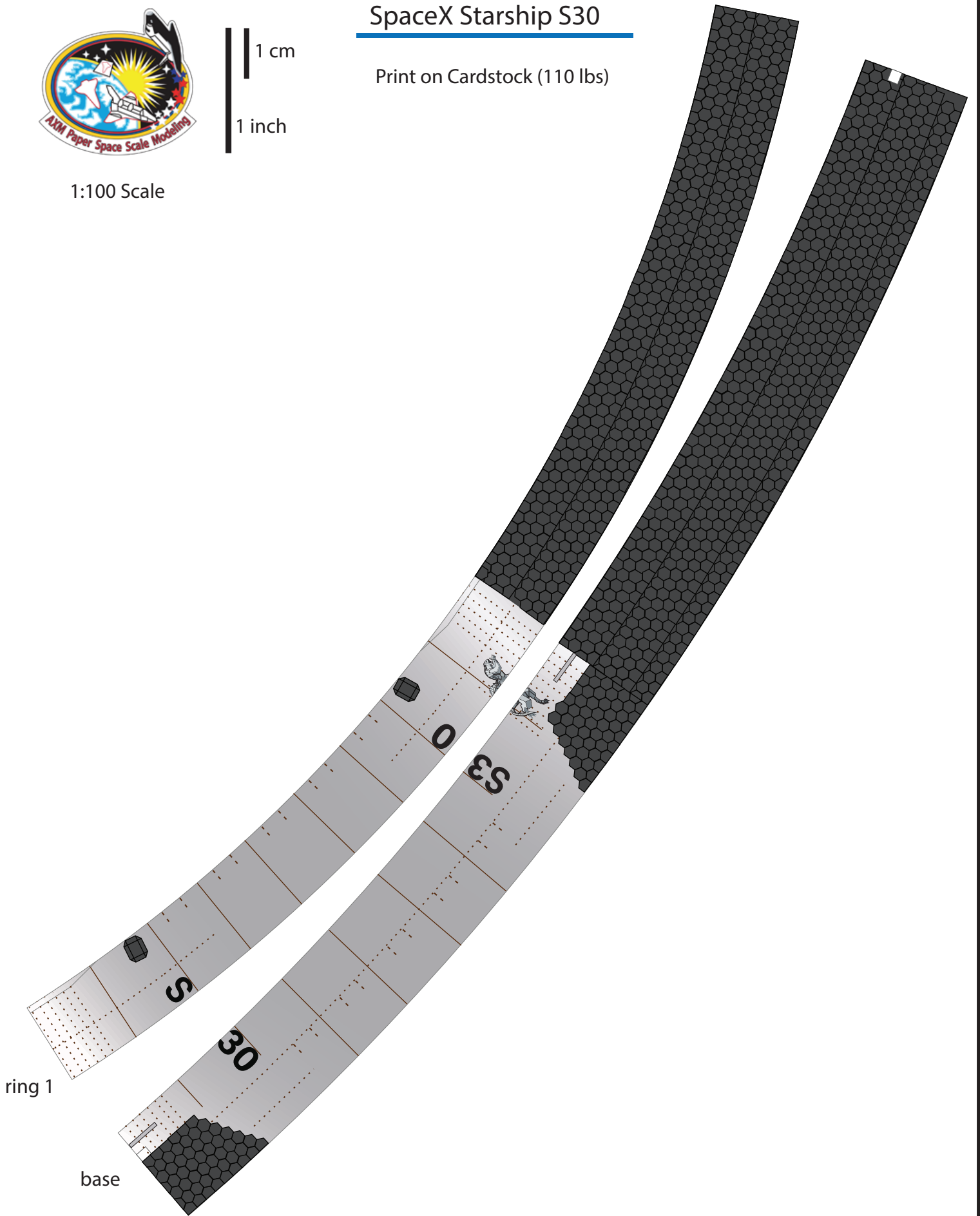



1:100 Scale

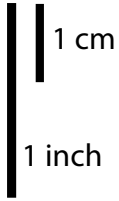

SpaceX Starship

Print on Cardstock (110 lbs)

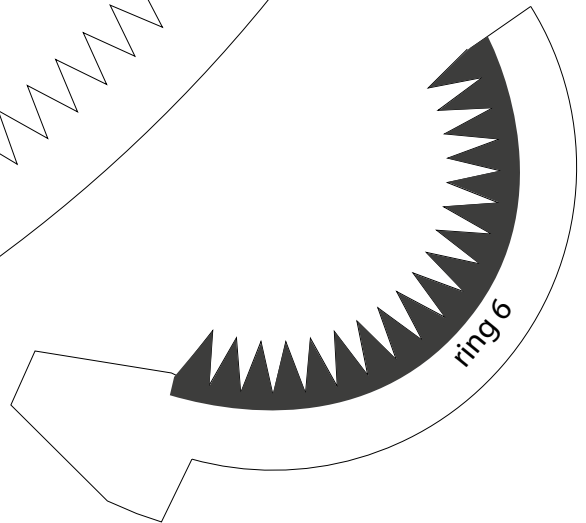
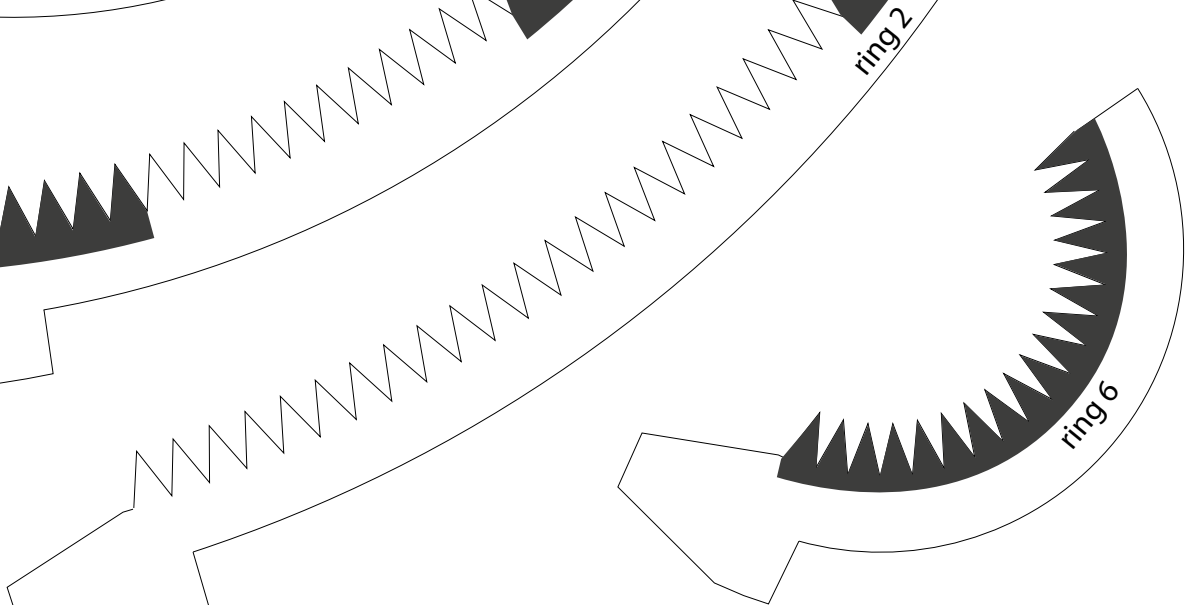
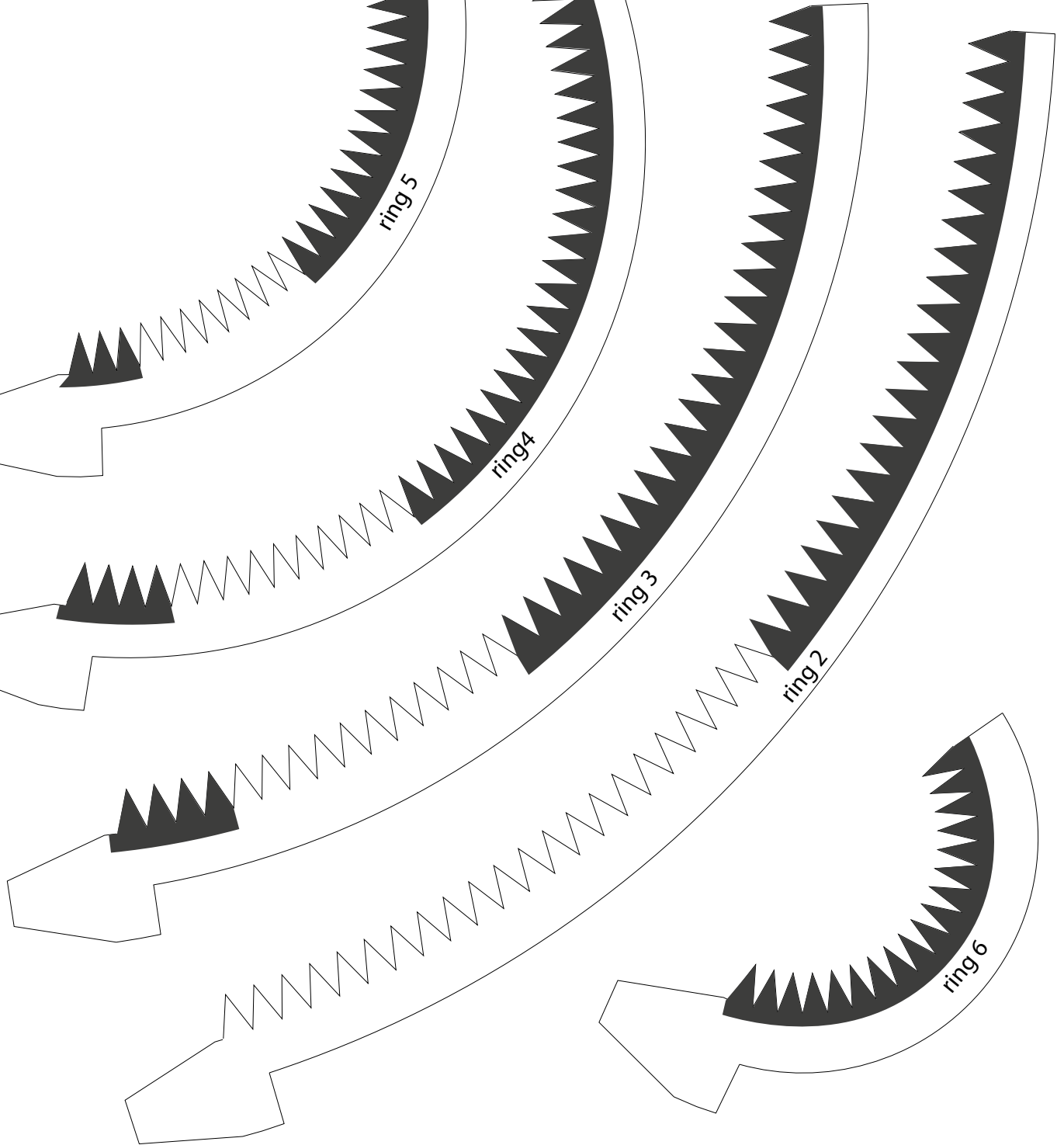
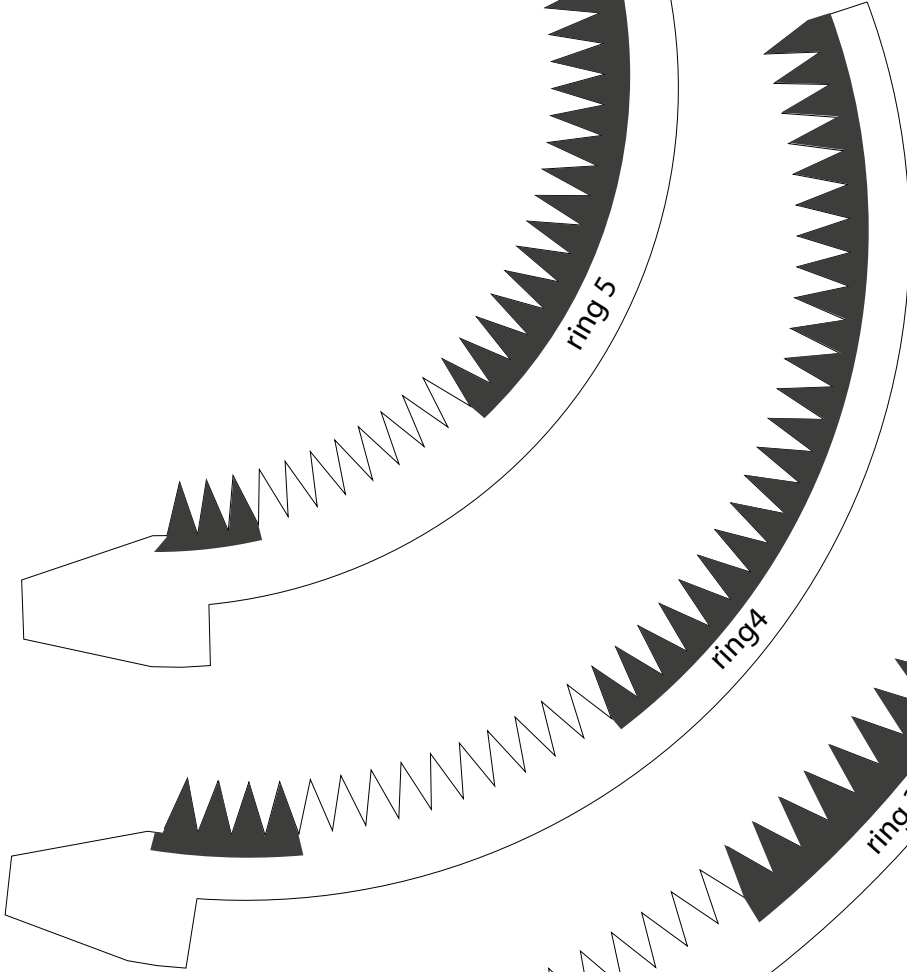
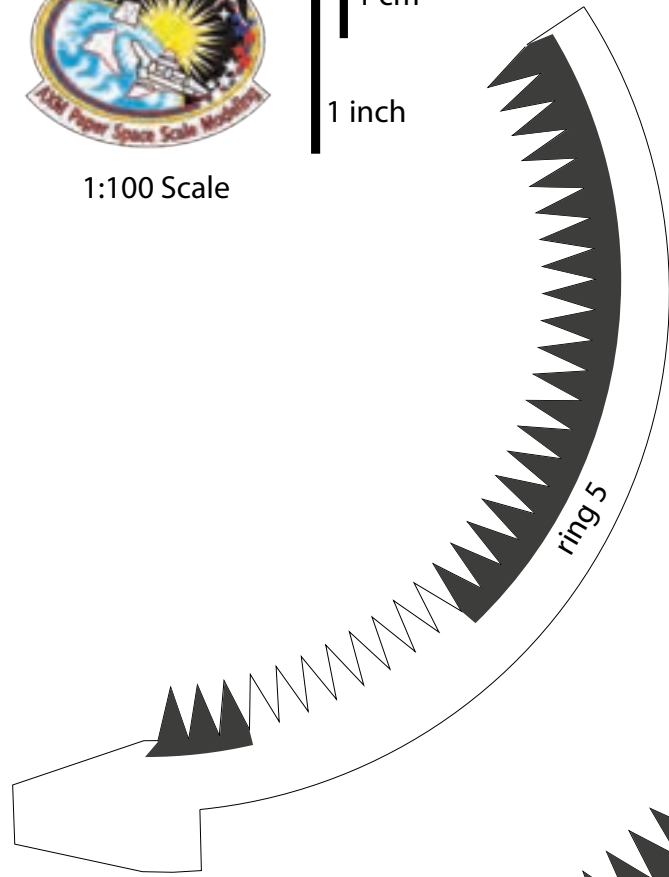
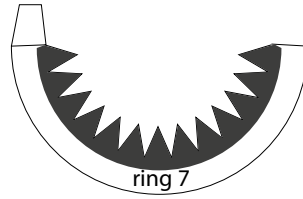



1:100 Scale

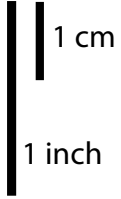

SpaceX Starship

Print on Cardstock (110 lbs)

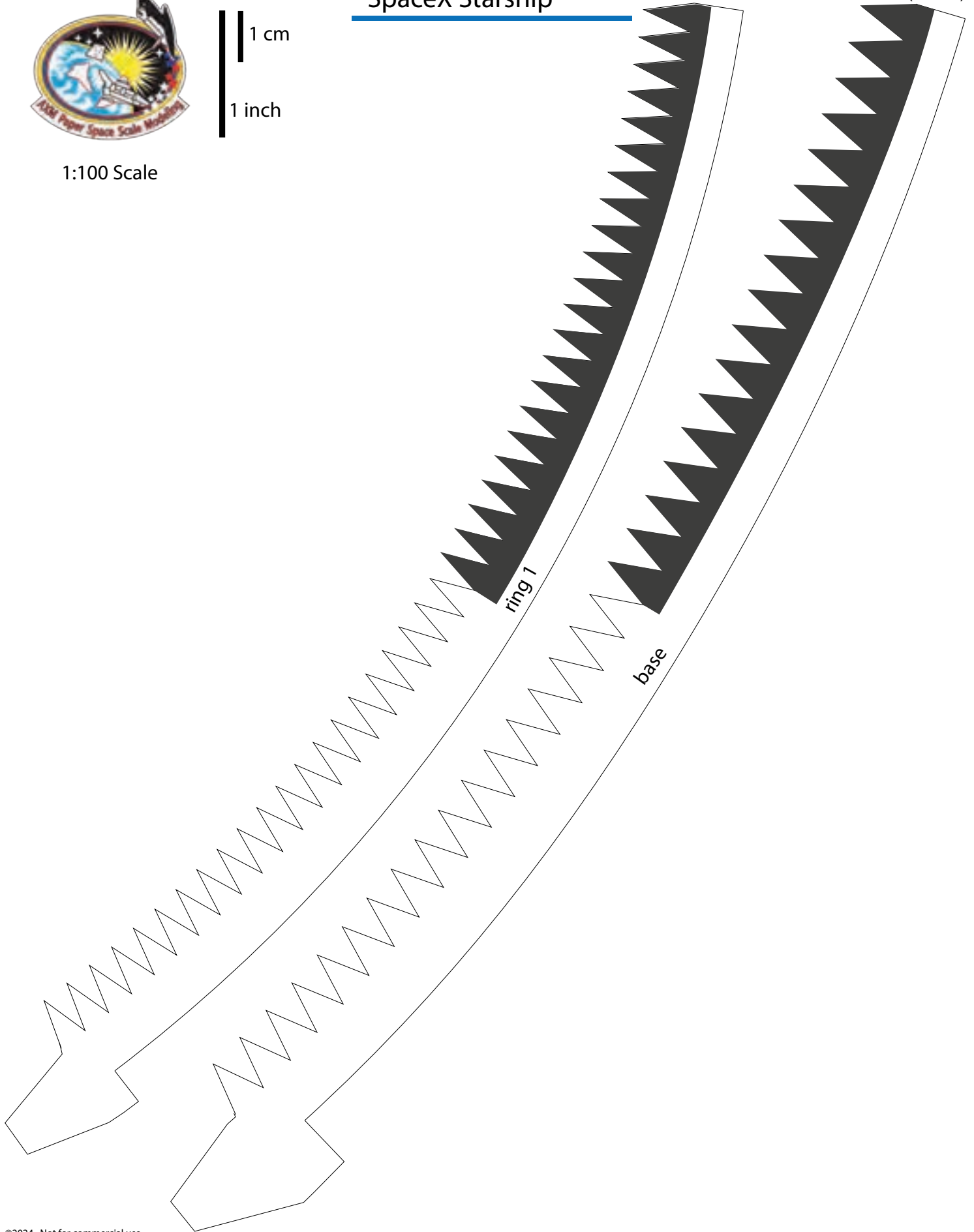



1:100 Scale

SpaceX Starship S30

Print on Cardstock (110 lbs)

1 cm

1 inch

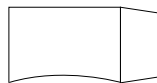
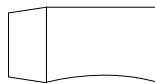
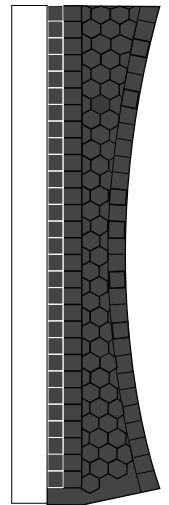
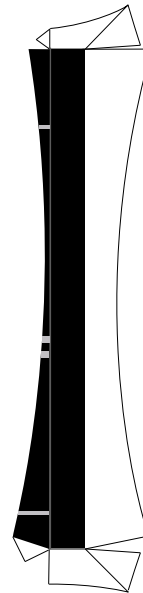
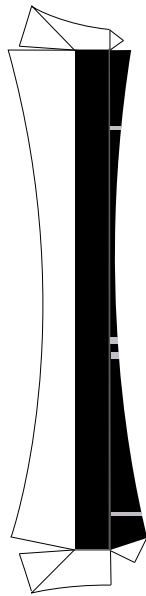
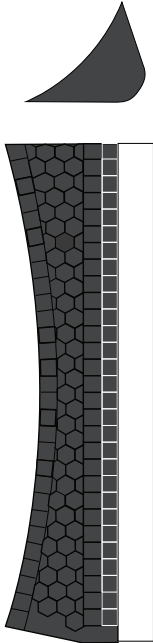
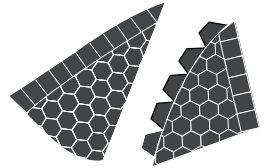
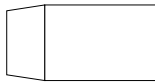
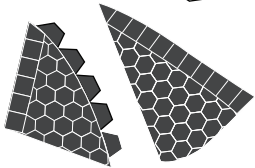
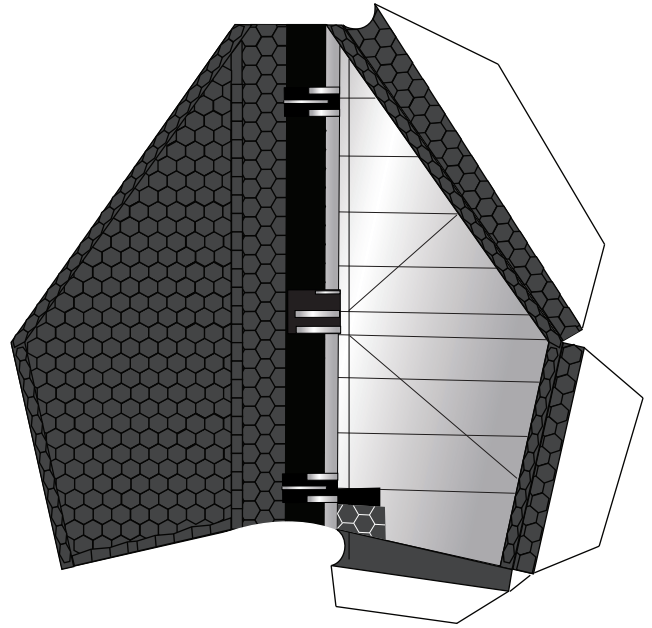
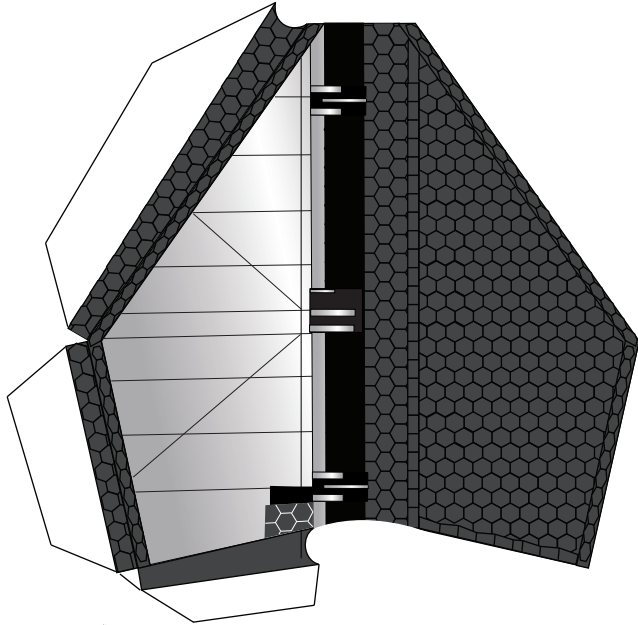



1 cm

1 inch

1:100 Scale

Starship S30 Upper Dome

Print on Cardstock (110 lbs)

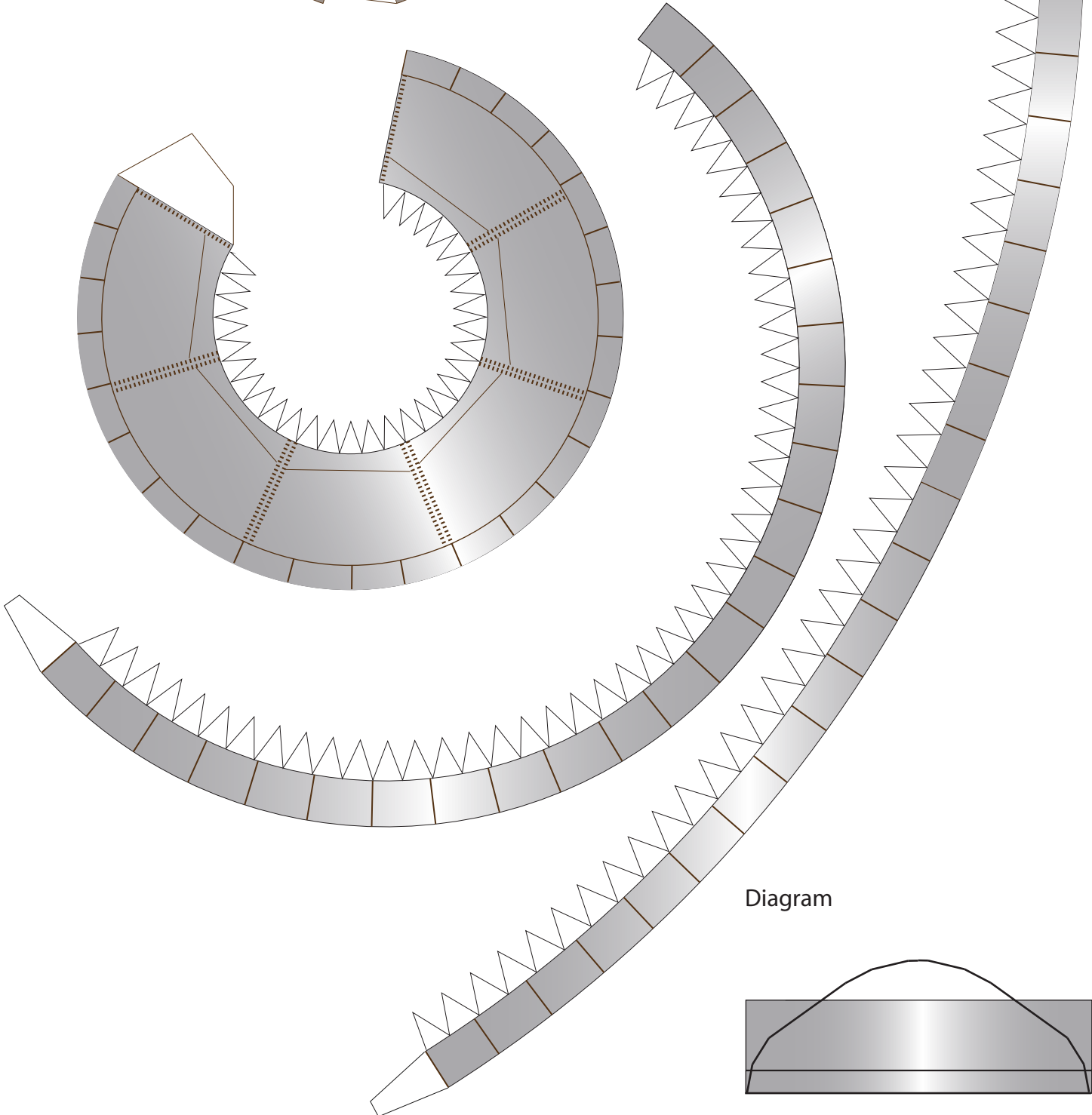
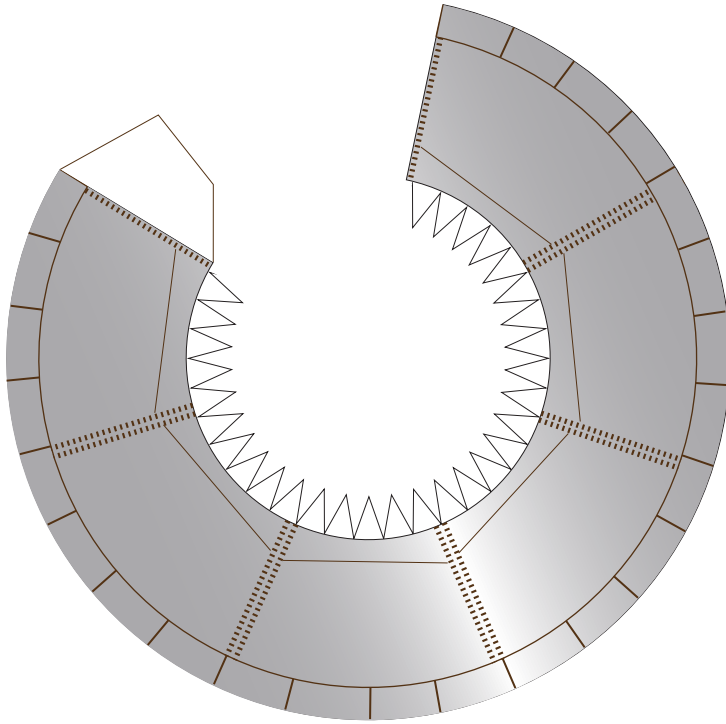
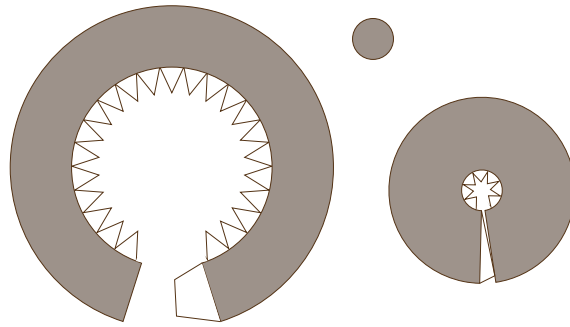

Diagram

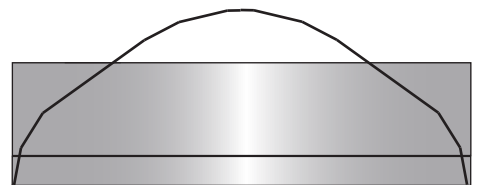



1:100 Scale

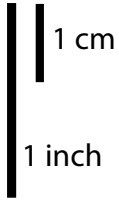

SpaceX Starship S30

Former for upper dome

Print on Cardstock (110 lbs)

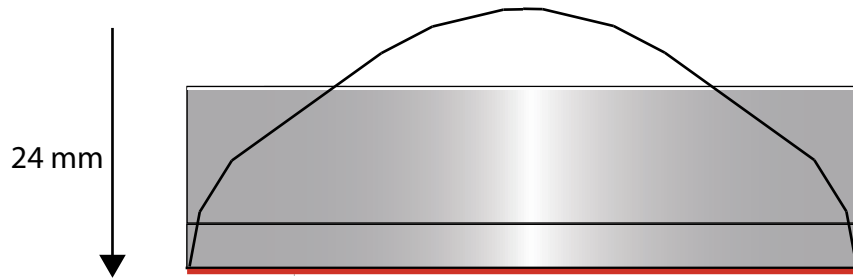
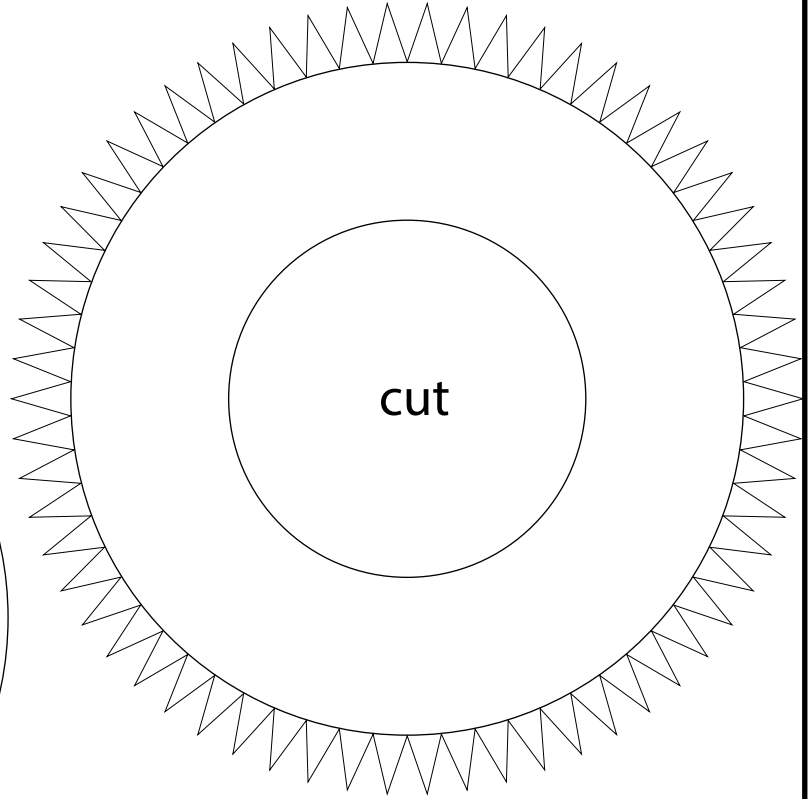
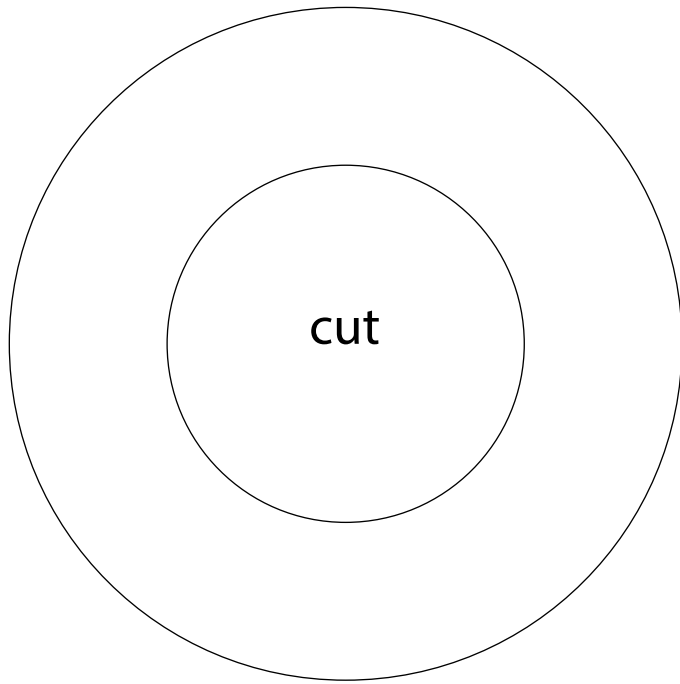

IMPORTANT

Top former is glued 24 mm from top edge of upper body for Starship S28 model



1 cm

1 inch

1:100 Scale

SpaceX Starship S30

Print on Cardstock (110 lbs)

Nosecone-body 5 ring stack

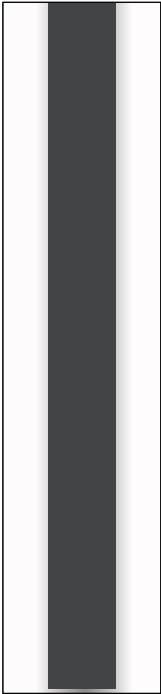

Umbilical side

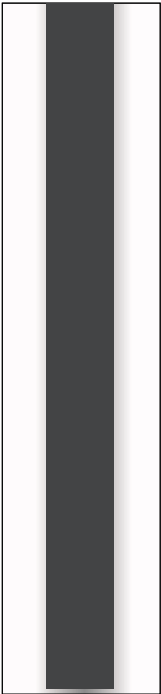
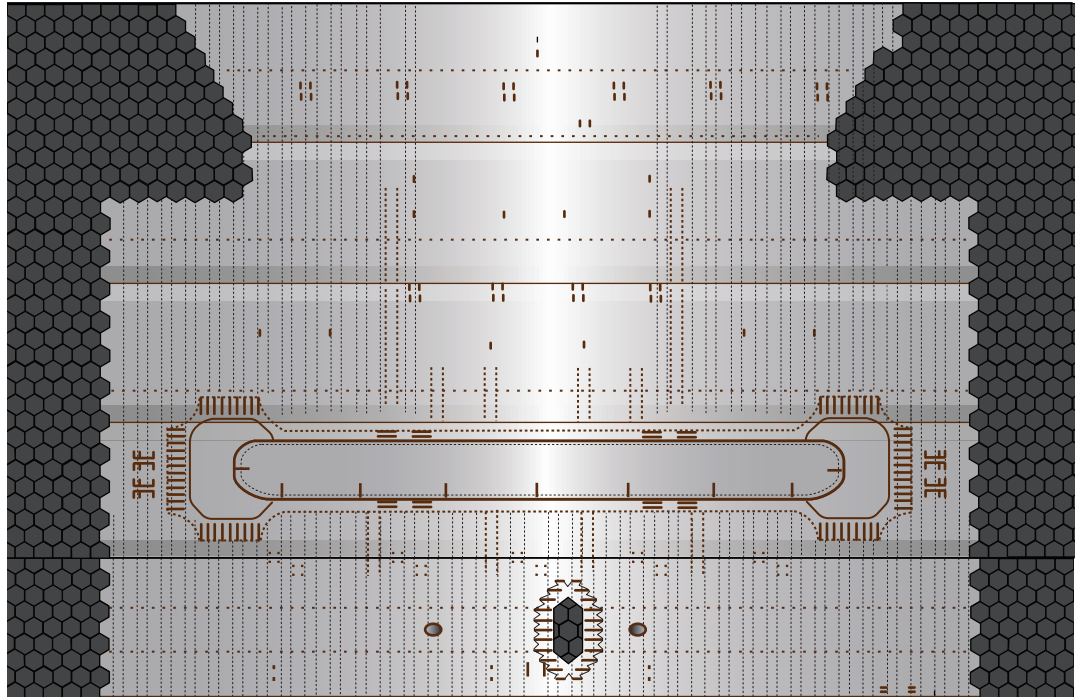

Front

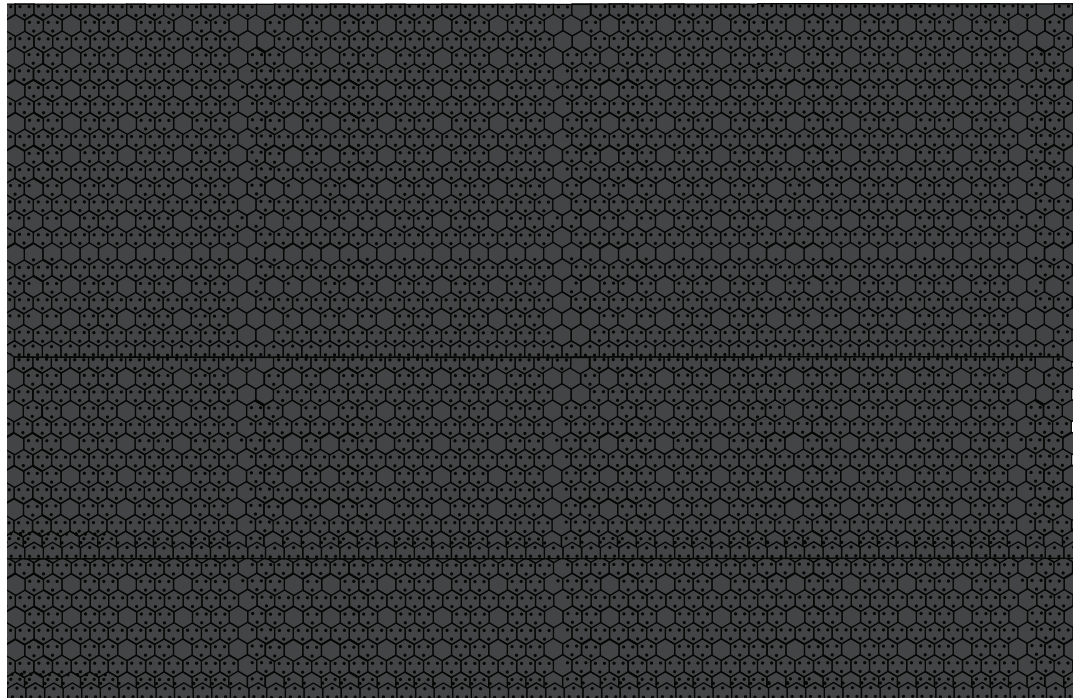

Connectors for 5 ring stack and body





1:100 Scale

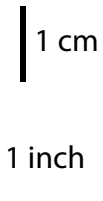

SpaceX Starship S30

Print on Cardstock (110 lbs)

Back top

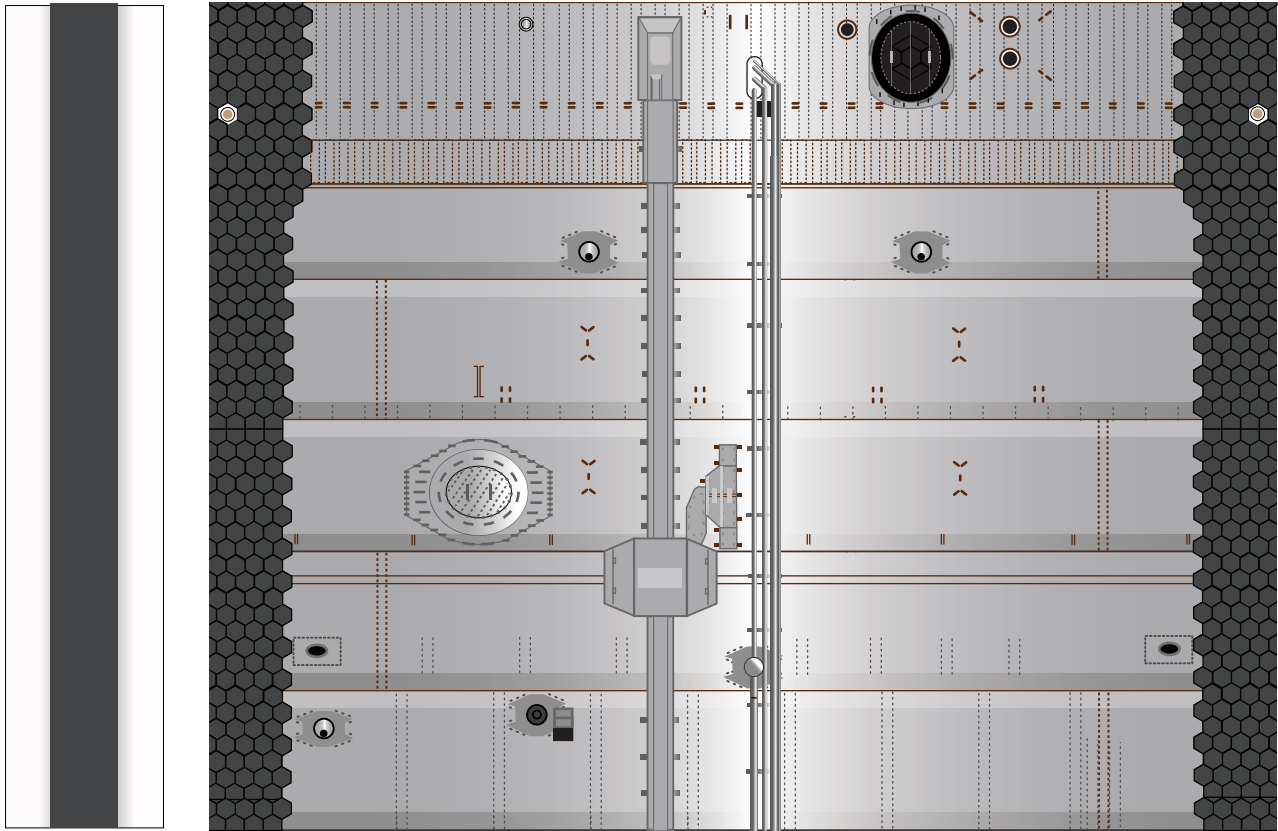
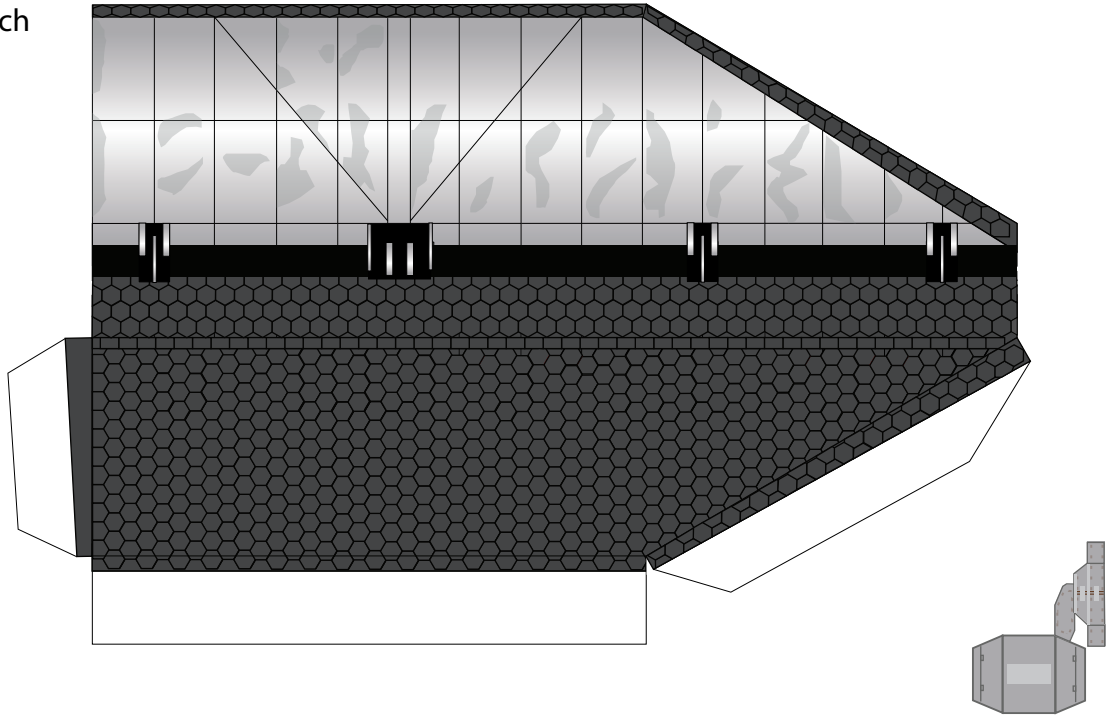



1:100 Scale

1 cm
1 inch

SpaceX Starship S30

Print on Cardstock (110 lbs)

Belly top

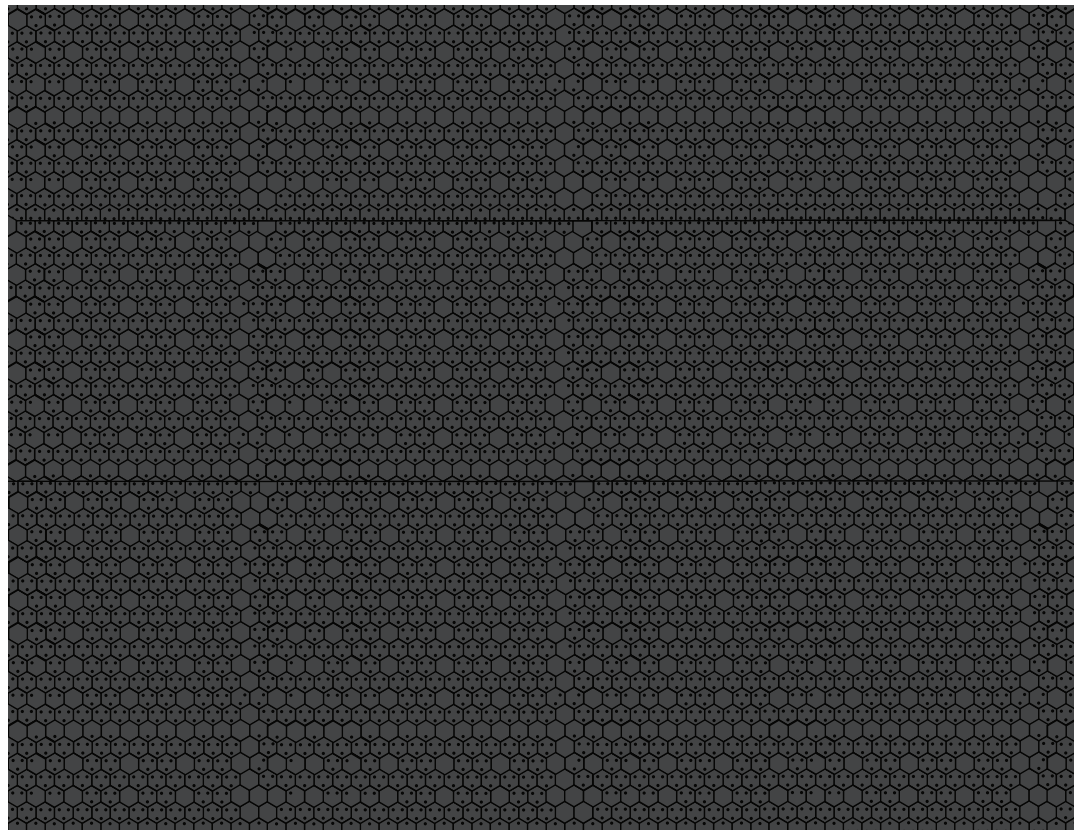
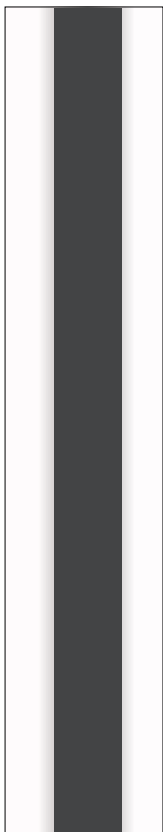
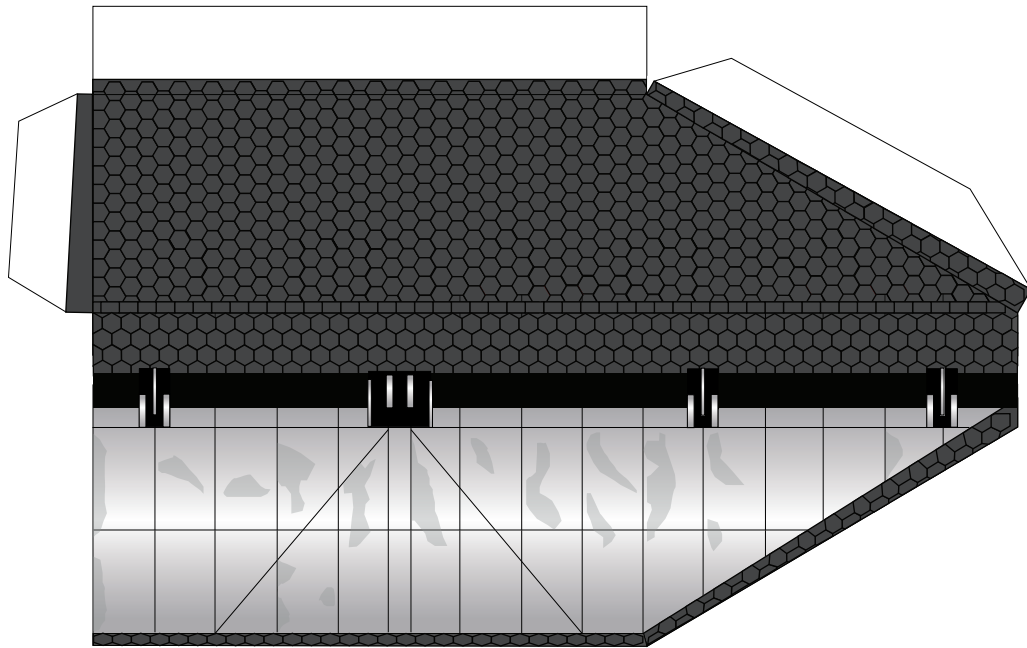



1:100 Scale



SpaceX Starship S30

Print on Cardstock (110 lbs)

Back bottom

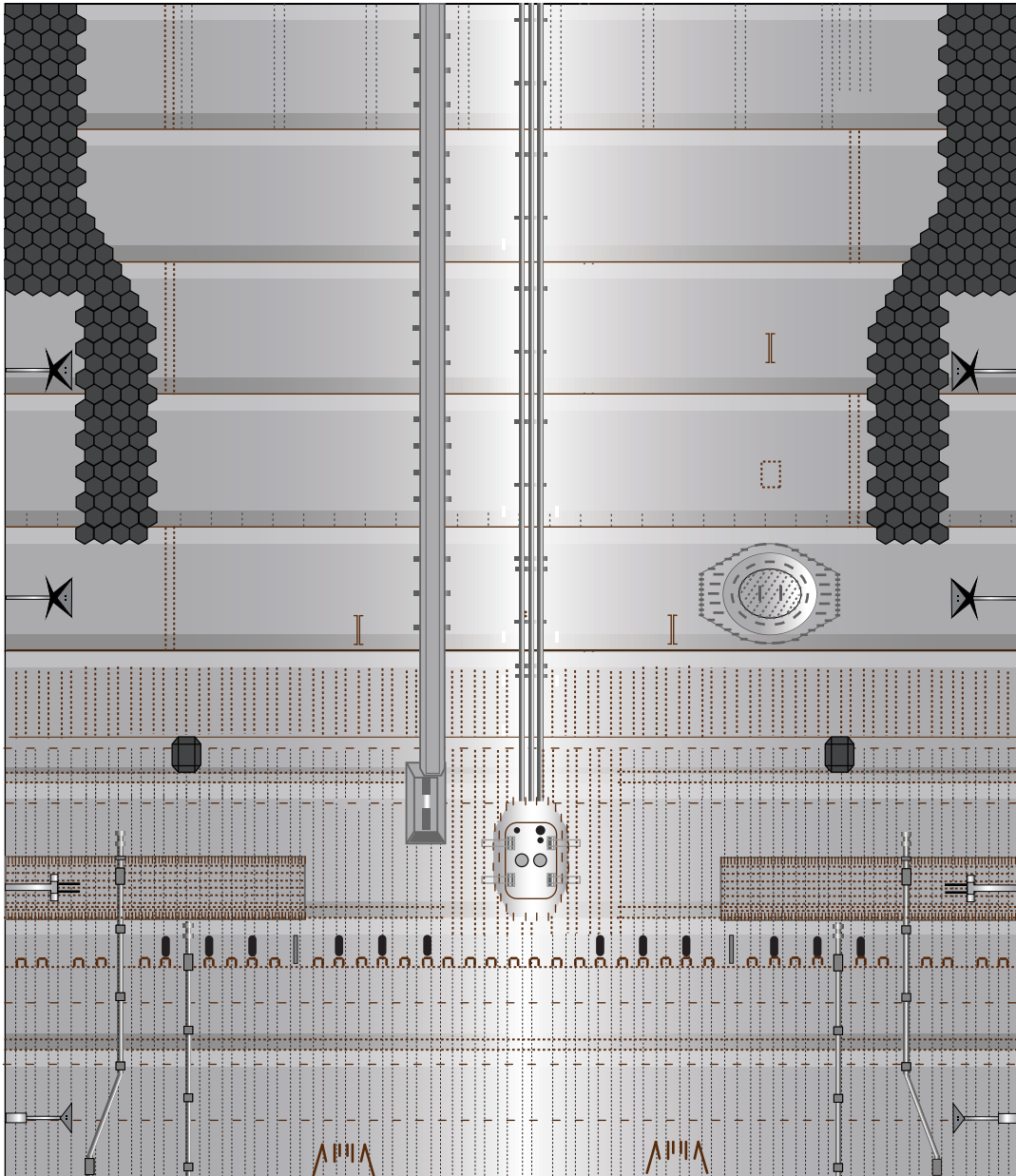
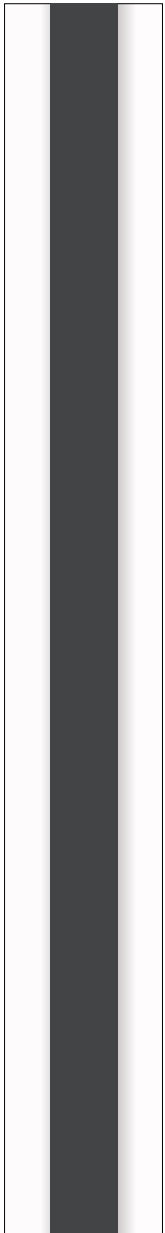



1:100 Scale



SpaceX Starship S30

Print on Cardstock (110 lbs)

Belly side bottom

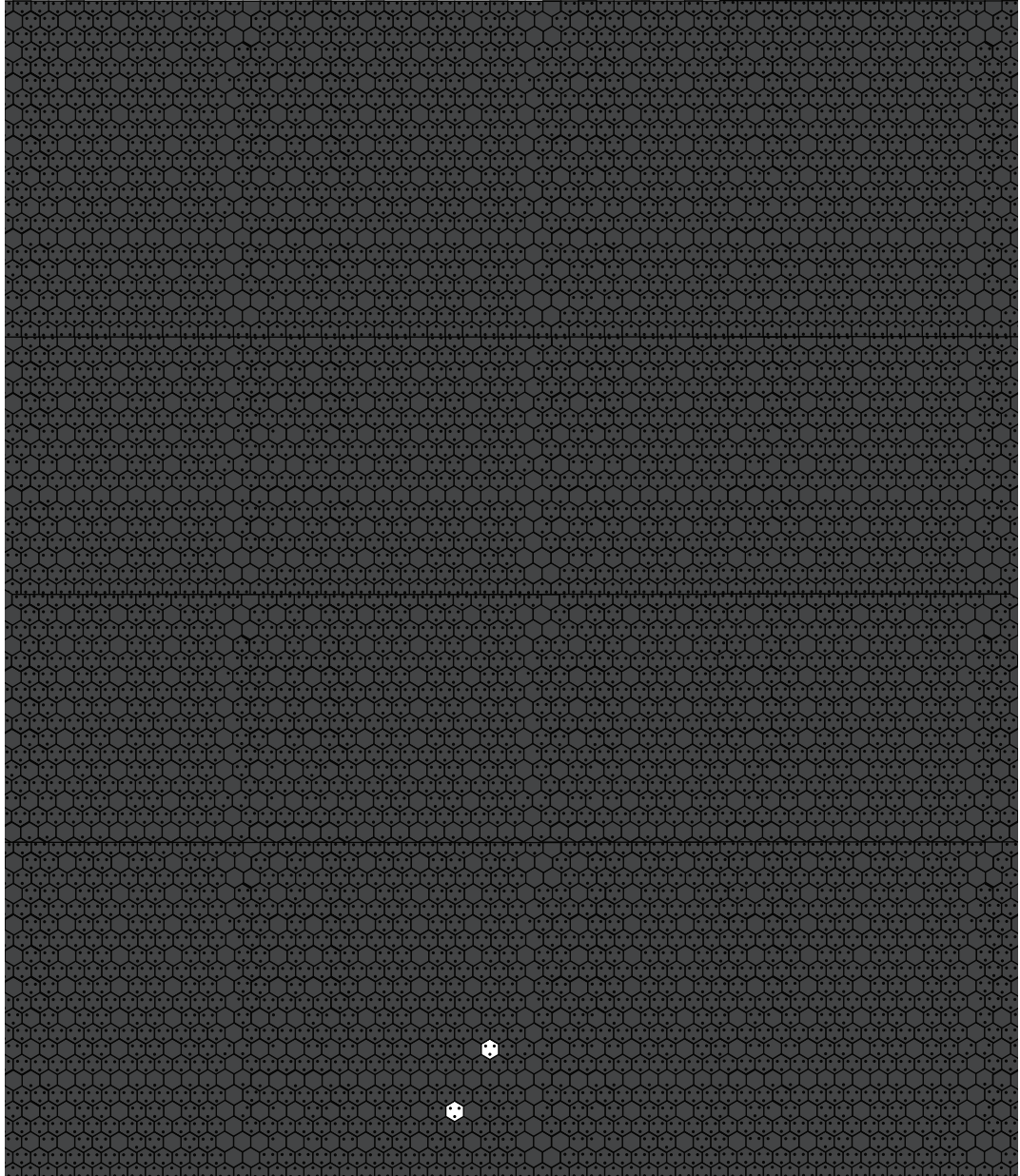
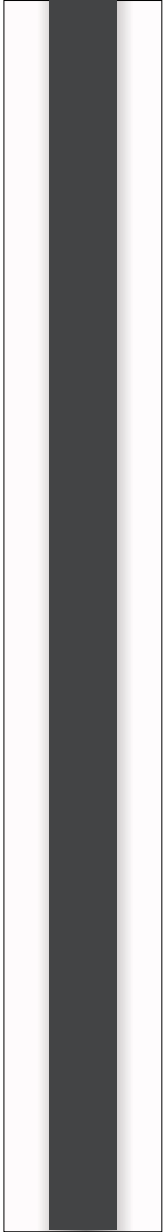



1:100 Scale

SpaceX Starship S30

Print on Cardstock (110 lbs)

1 cm

1 inch

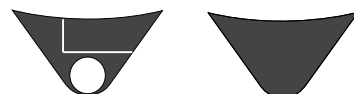
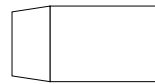
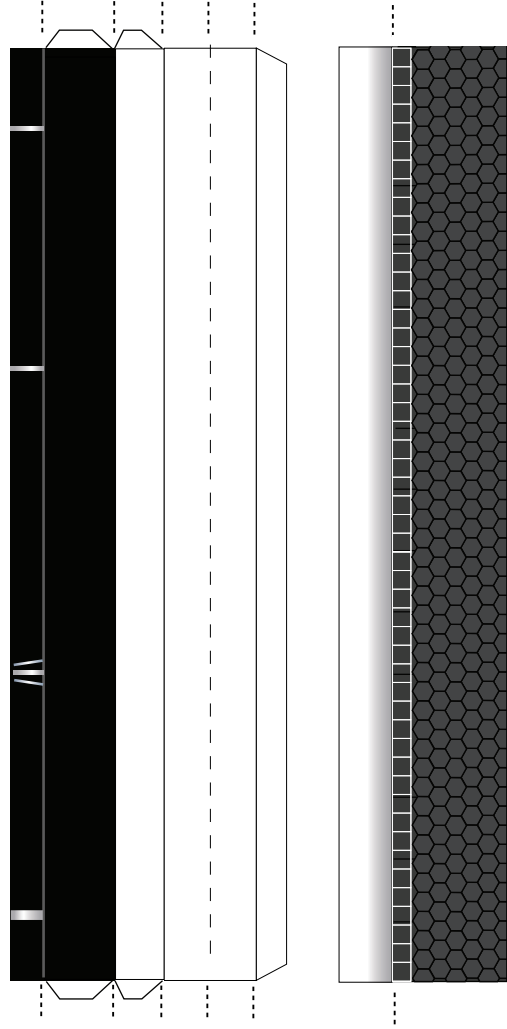
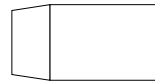
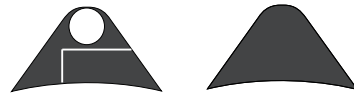
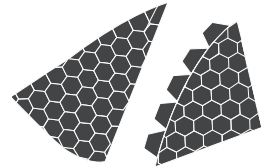
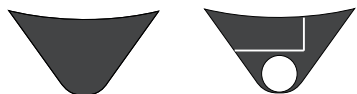
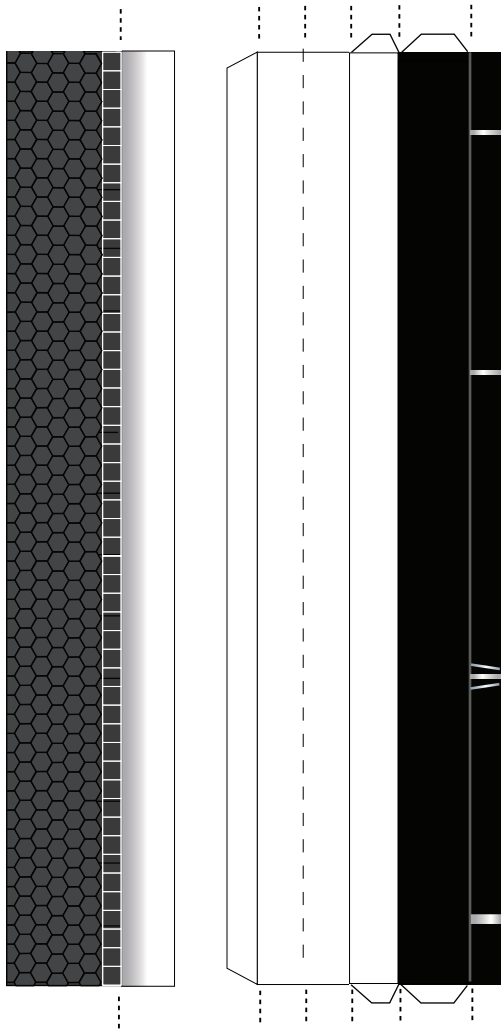
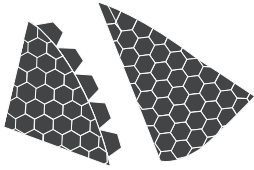



1:100 Scale



SpaceX Starship

Print on Cardstock (110 lbs)

Formers for lower body

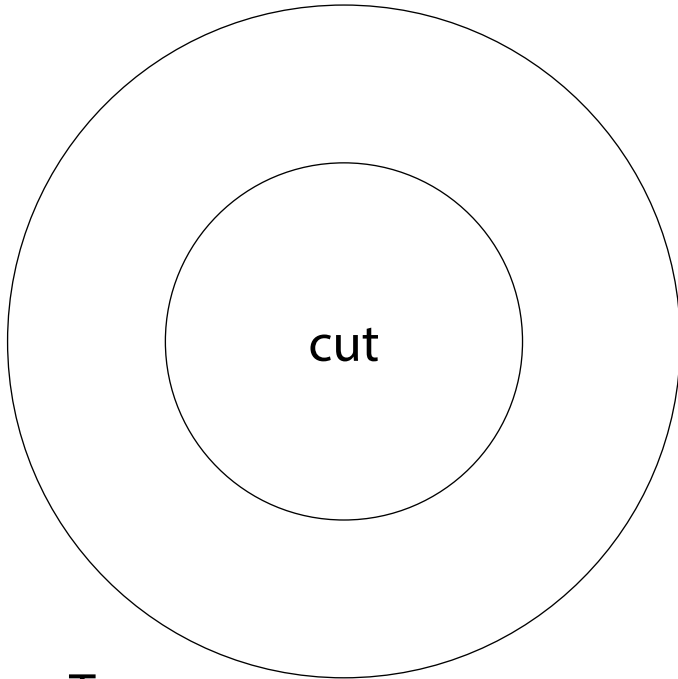

Top

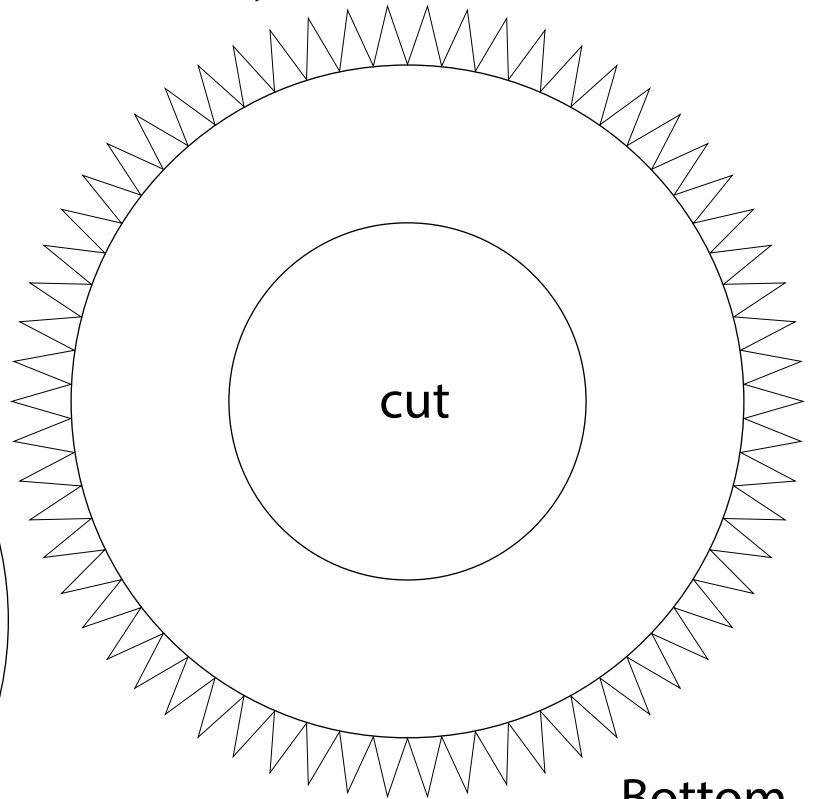

Bottom

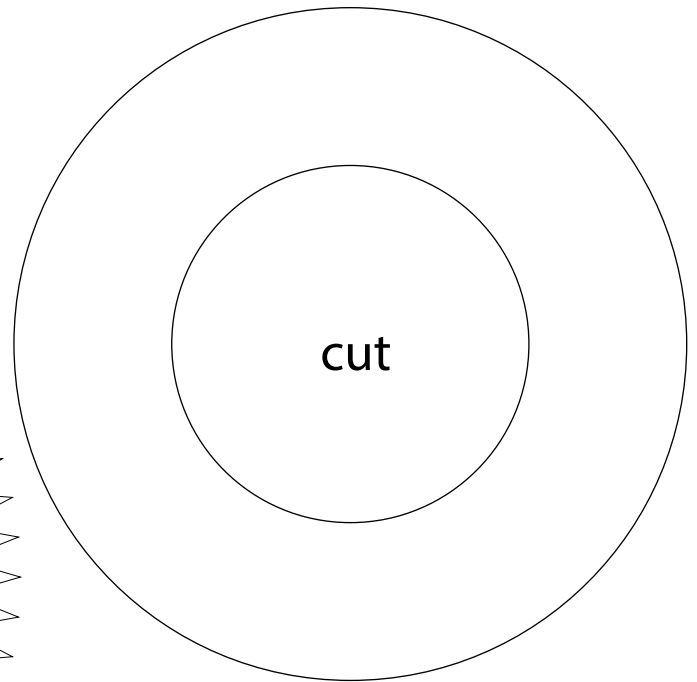
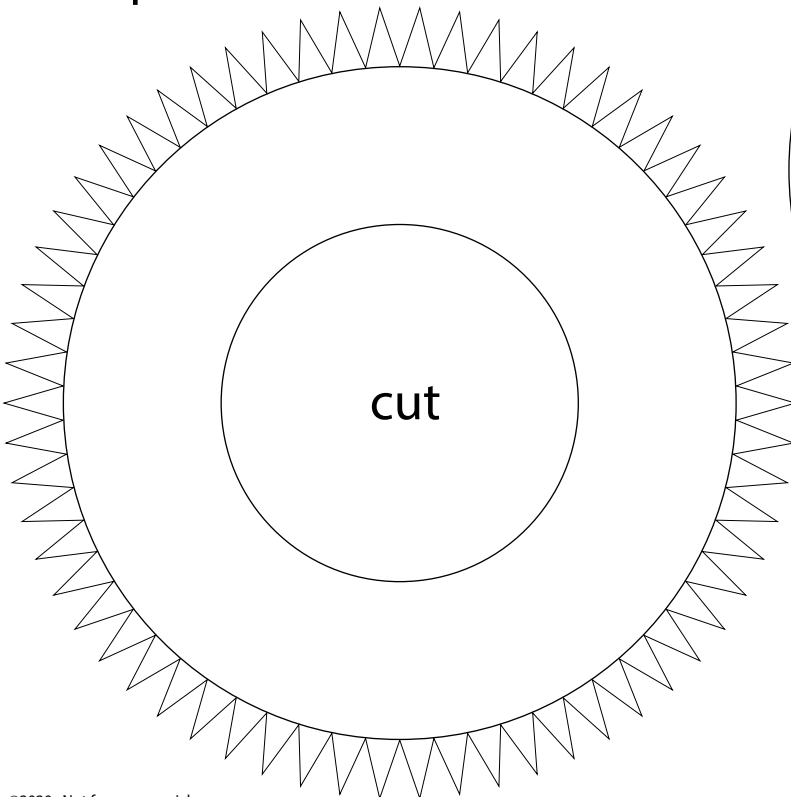

IMPORTANT

Top former is glued 20 mm from bottom edge of upper body.
Bottom former is glued 27 mm from bottom edge of lower body.



1 cm

1 inch

1:100 Scale

SpaceX Starship S29

Print on Cardstock (110 lbs)

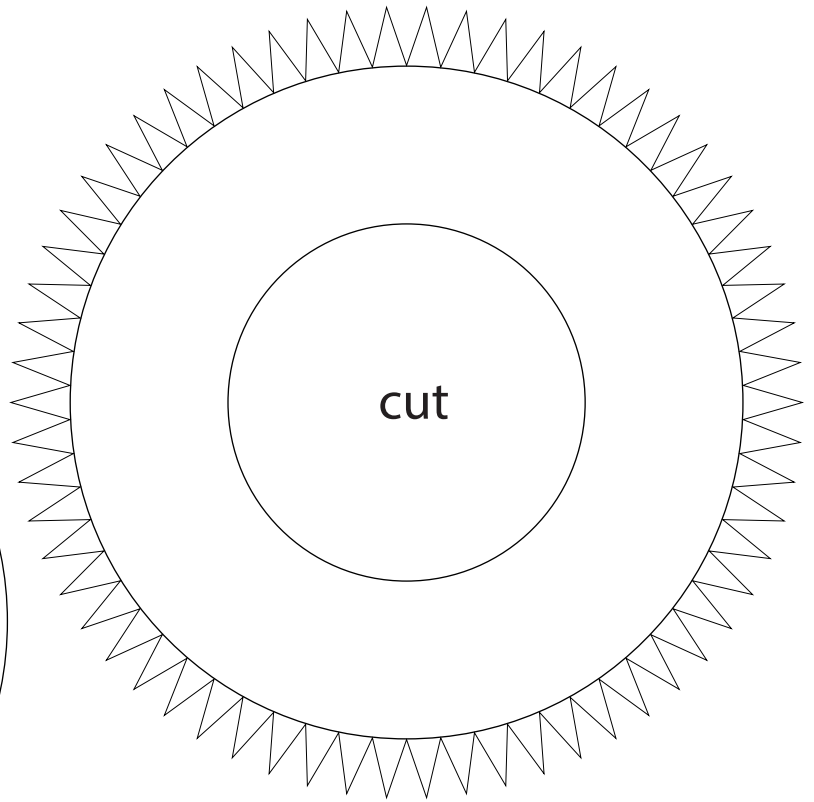
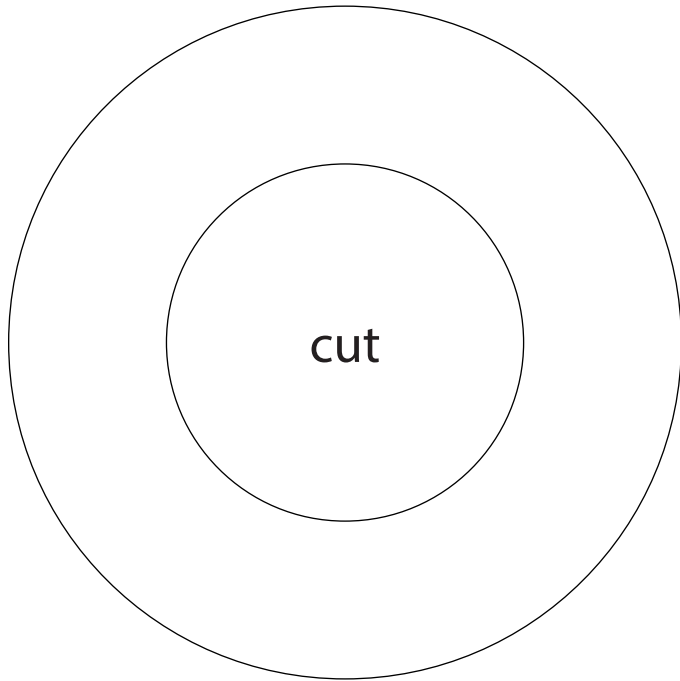

Upper Body former

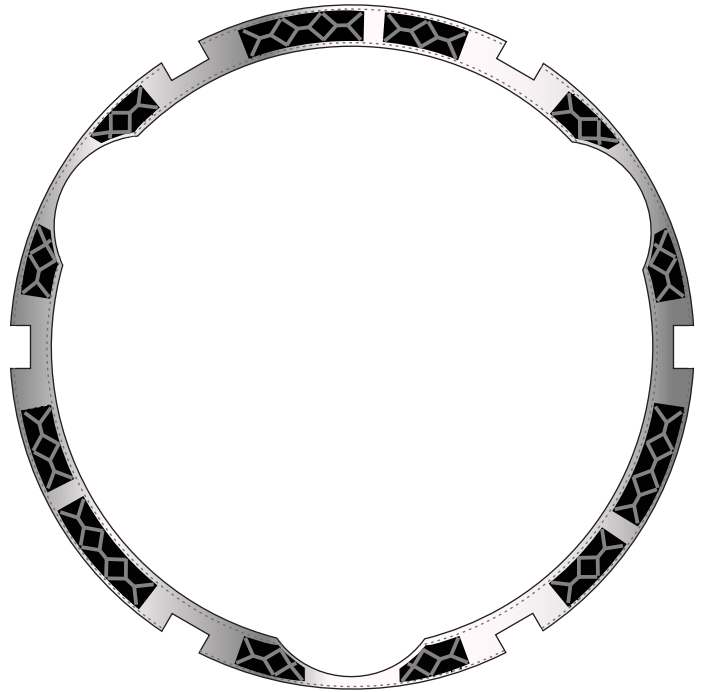

Engine ring



1:100 Scale

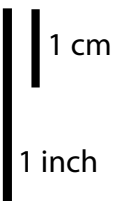

SpaceX Starship S30

Print on Cardstock (110 lbs)

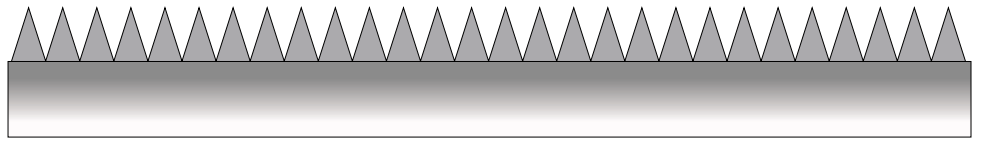

Nosecone connectors
(Use for a closed Ship
with no interior)

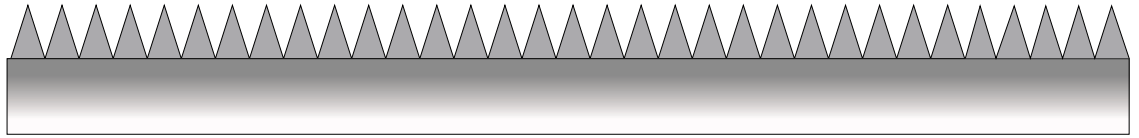

Connectors for upper
and lower body

Upperdome
interior wall

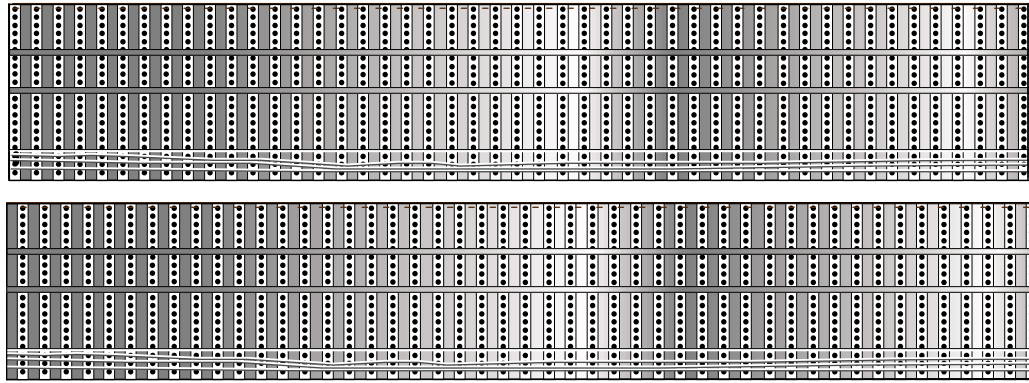

LOX dump pipes

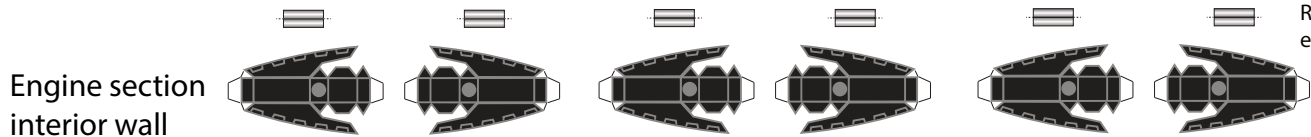
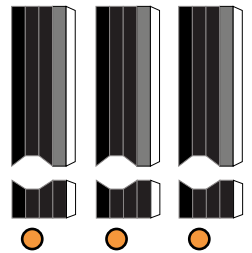

Engine section
interior wall

Raptor Vacuum
engine supports

umbilical
side

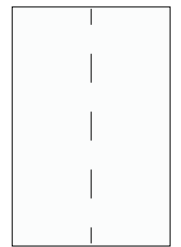
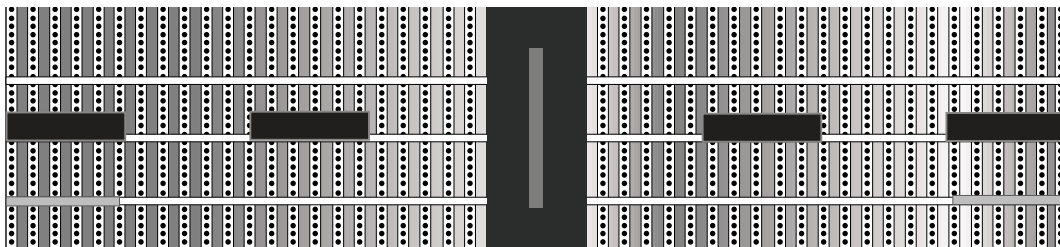

LOX dump pipe locations

tile side

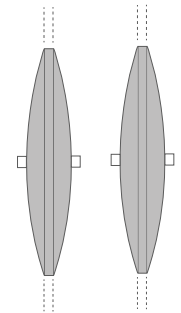
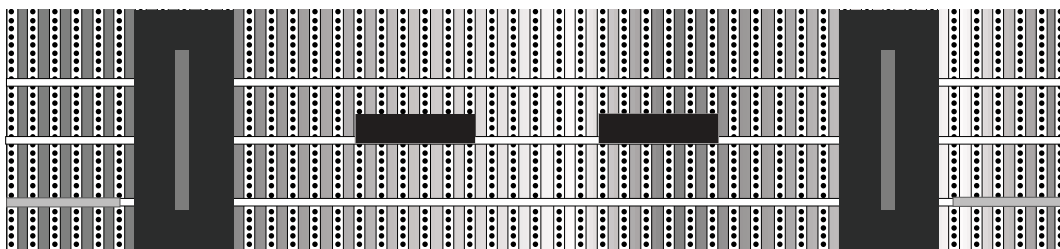



1 cm

1 inch

1:100 Scale

SpaceX Starship S30

Print on Cardstock (110 lbs)

Engine floor

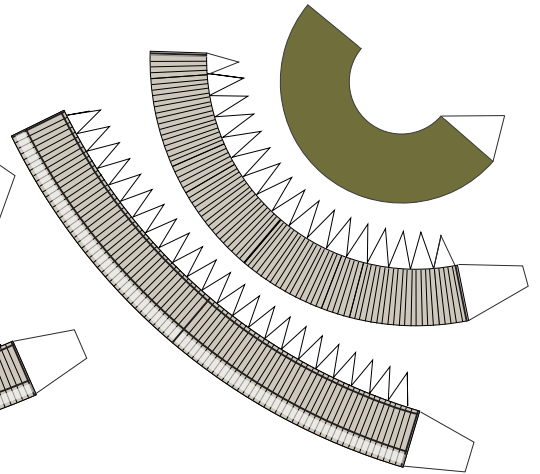
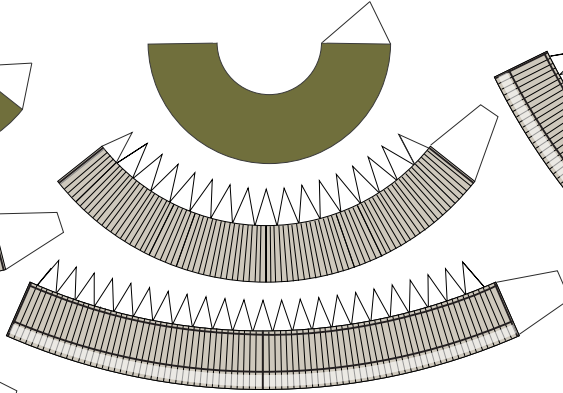
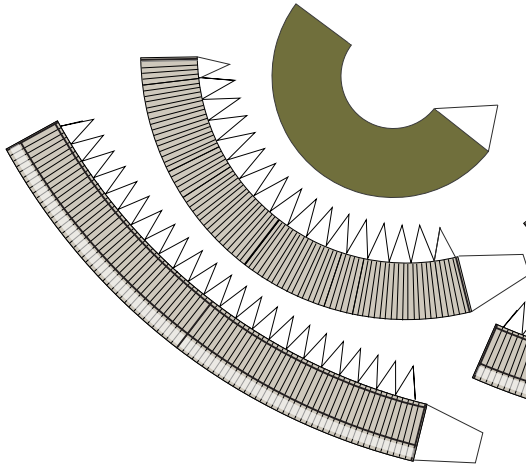
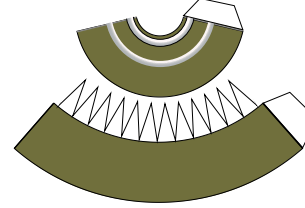
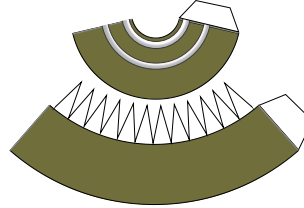
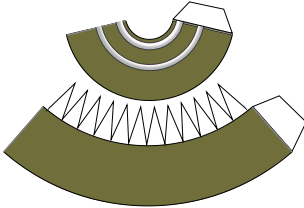
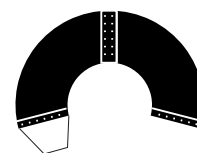
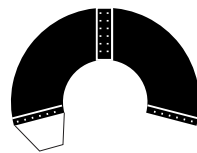
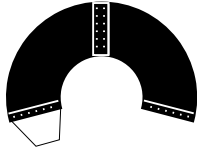
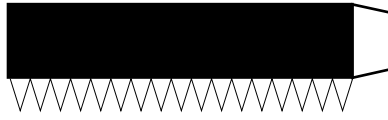
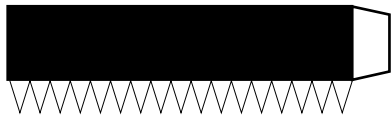
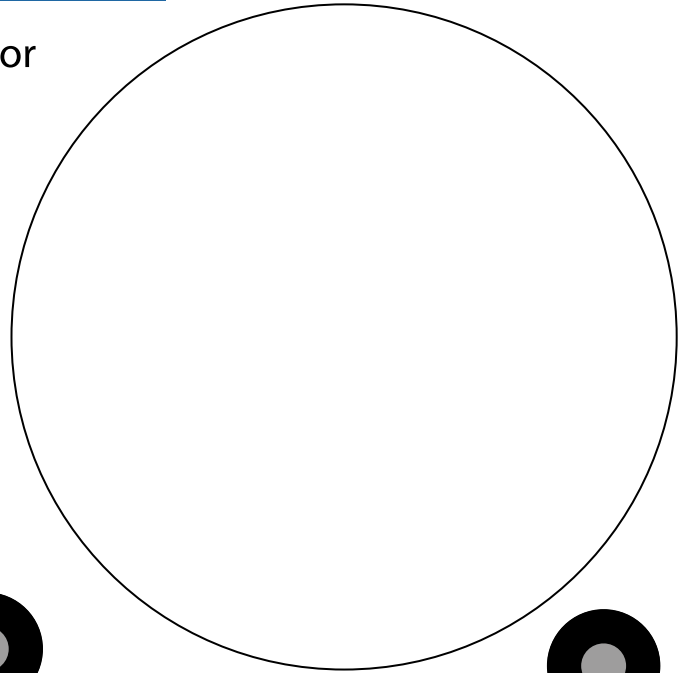
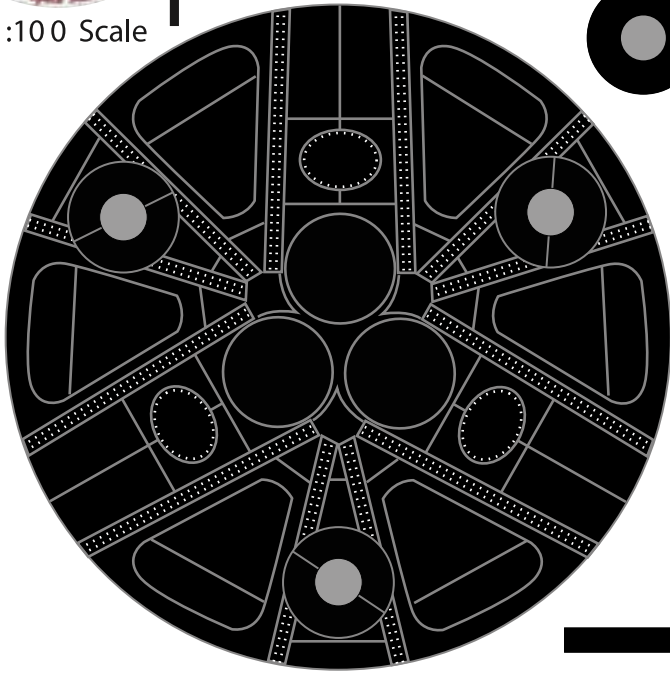

Raptor engine floor designed by @ChameleonCir



1:100 Scale



SpaceX Starship S29

Print on Cardstock (110 lbs)

Engine floor back print





1:100 Scale

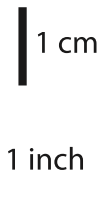

SpaceX Starship S30

Print on Cardstock (110 lbs)

Position of bottom former for Raptor engine floor

Raptor engines and floor paper version

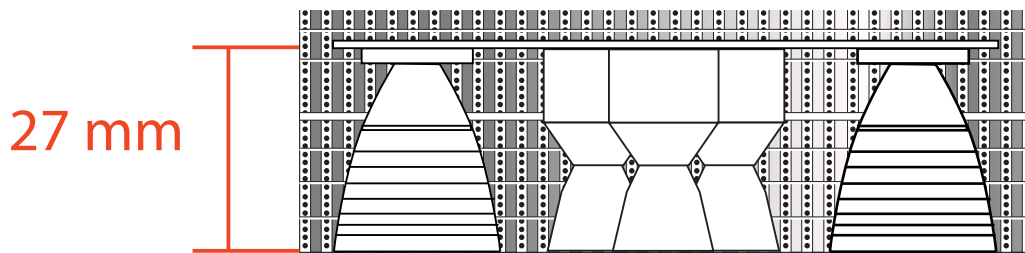

Raptor engines and floor 3D printable version

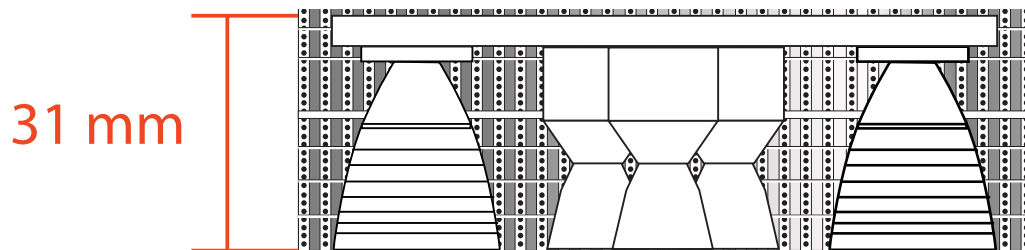



1 cm

1 inch

1:100 Scale

SpaceX Starship S30

Print on Cardstock (110 lbs)

Raptor Vacuum engine supports Diagram

Umbilical side

LOX dump
pipe

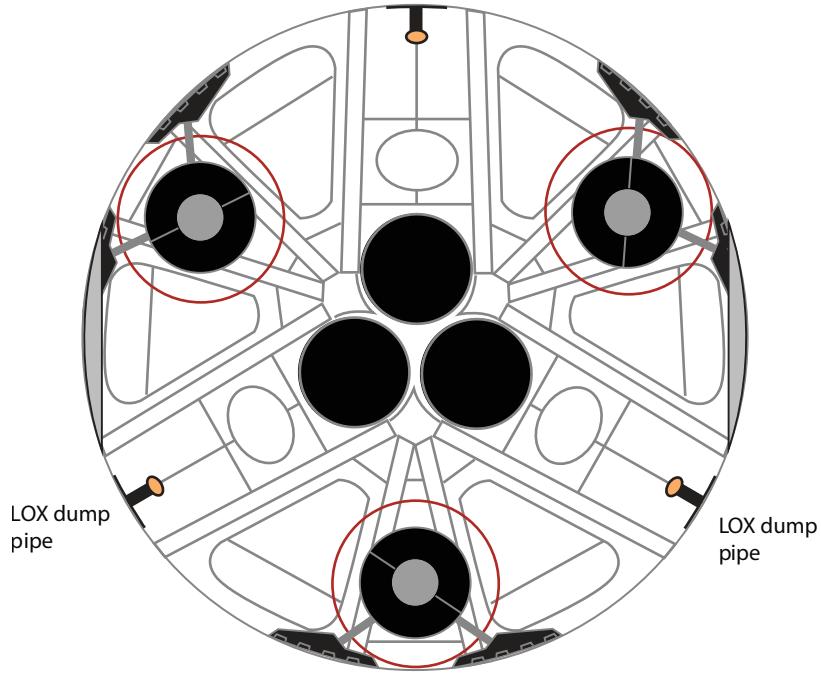

Tile side

Raptor location by @BingoBoca
Raptor engine floor designed by @ChameleonCir