

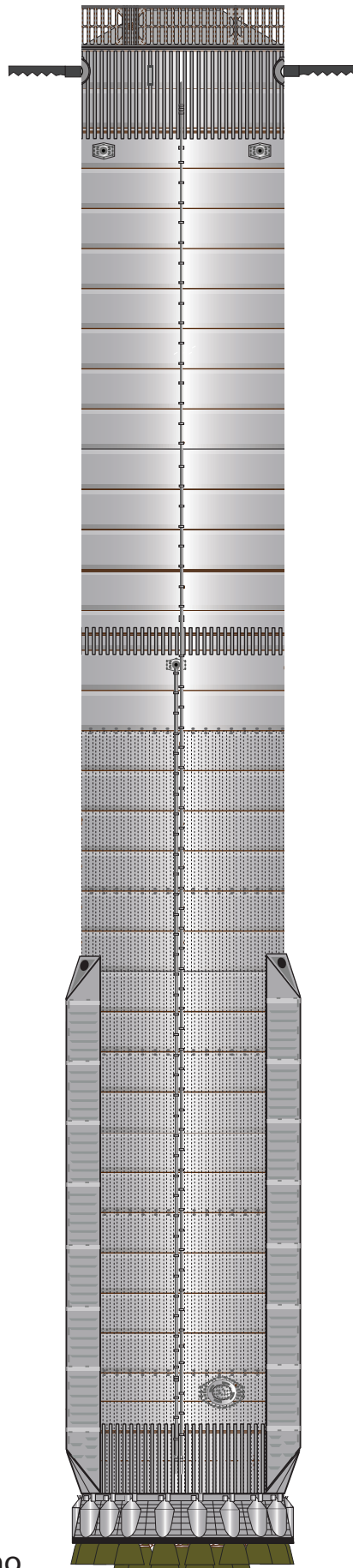

1:100 Scale

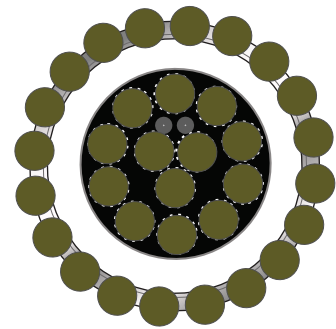

B10

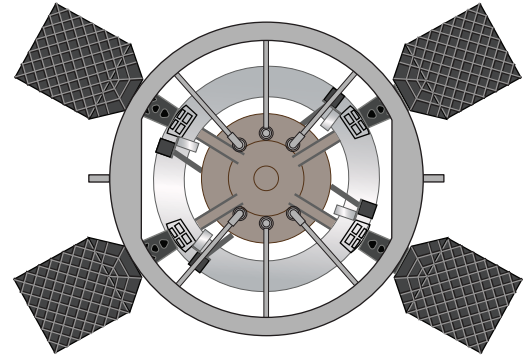
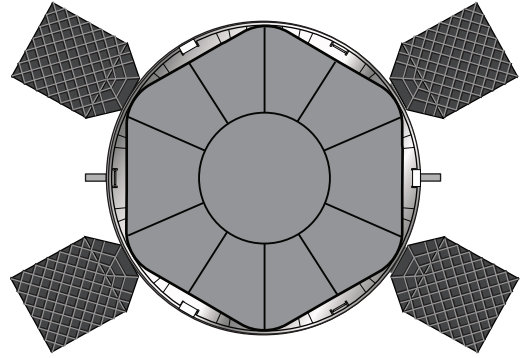

Designed by Alfonso X Moreno

©2024 Not for commercial use



1 cm

1 inch

1:100 Scale

Hot staging Ring

Print on Cardstock (110 lbs)

Top ring

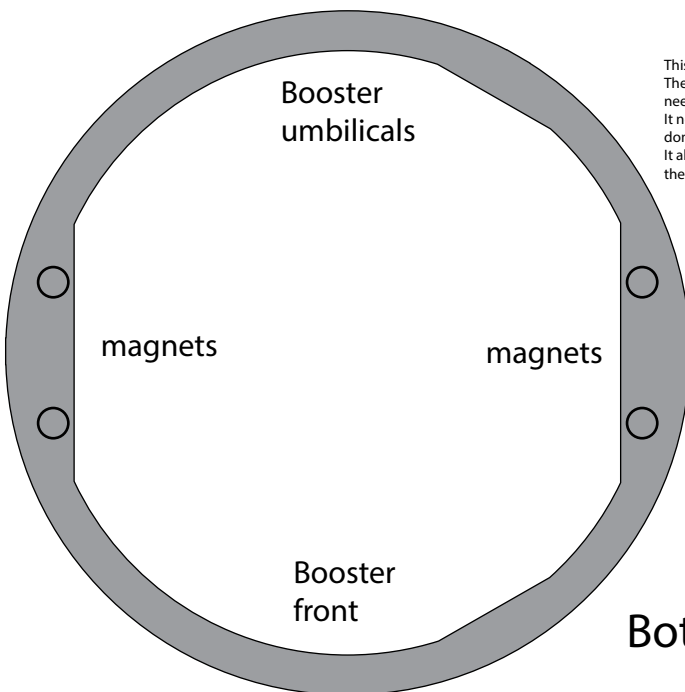
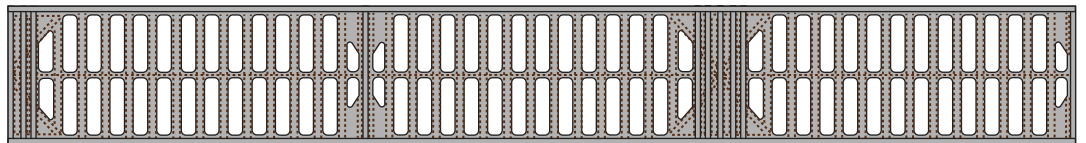
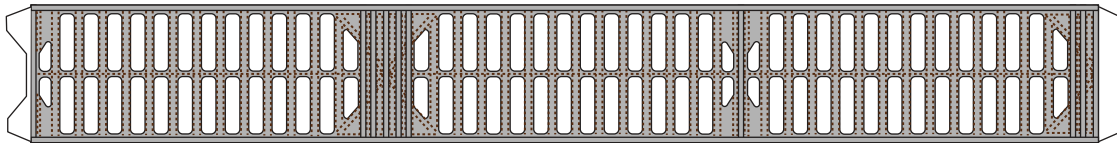
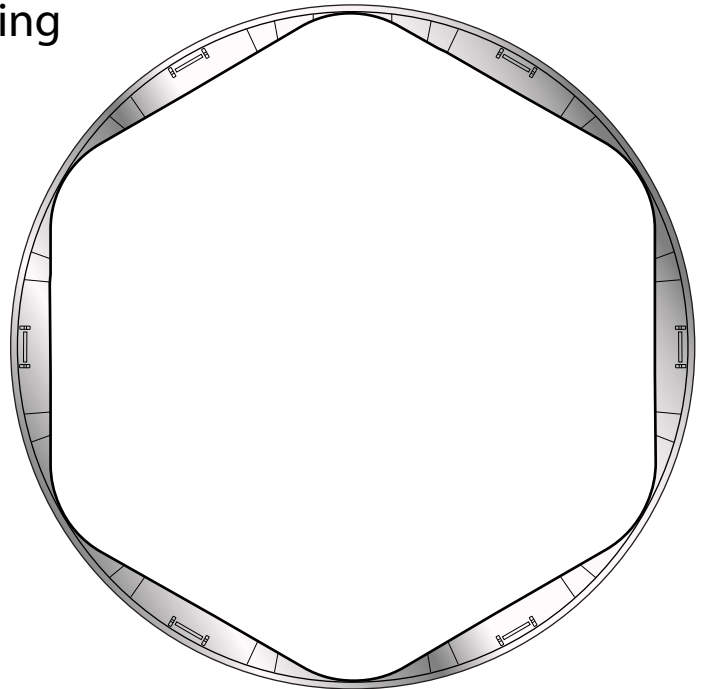
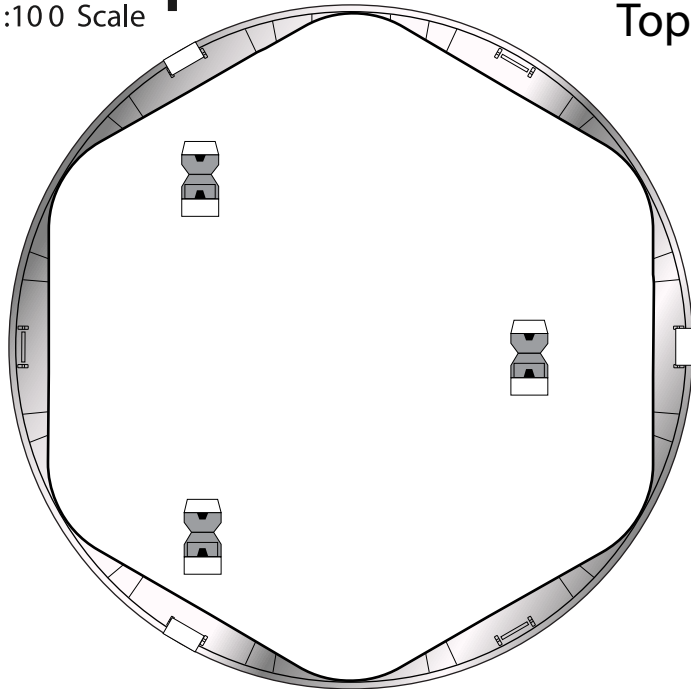

Booster umbilicals

magnets

magnets

Booster front

This flap is a guide only. The seamline of the dome needs to point to this flap. It needs to be cut once the dome is glued on top. It also identifies where the magnets are hidden.

right side

Bottom ring

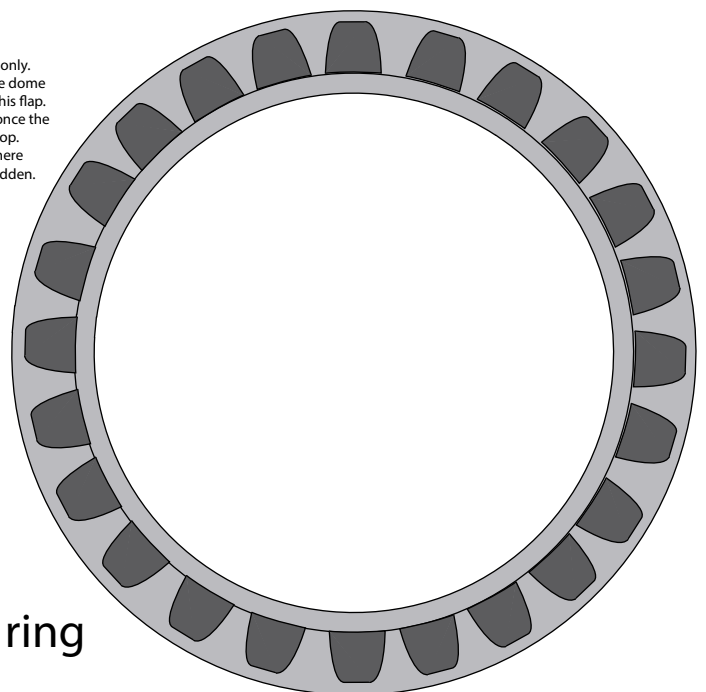



1:100 Scale

Hot staging Ring

Print on Cardstock (110 lbs)

Back Print





1 cm

1 inch

1:100 Scale

Hot staging Ring

Print on Cardstock (110 lbs)

Simple version

Exterior skin

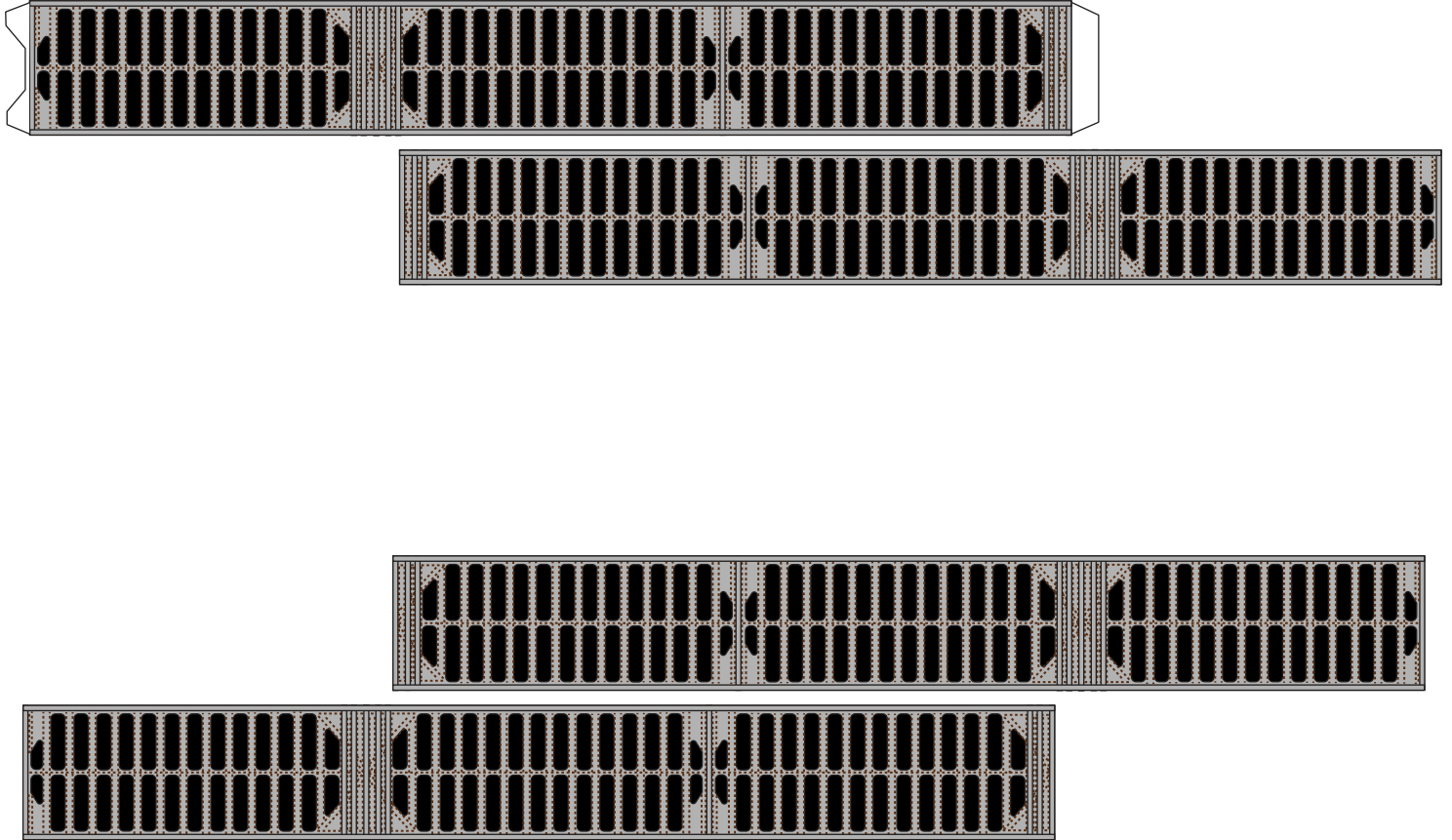

Interior skin



1 cm

1 inch

1:100 Scale

Hot staging Ring Dome

Print on Cardstock (110 lbs)

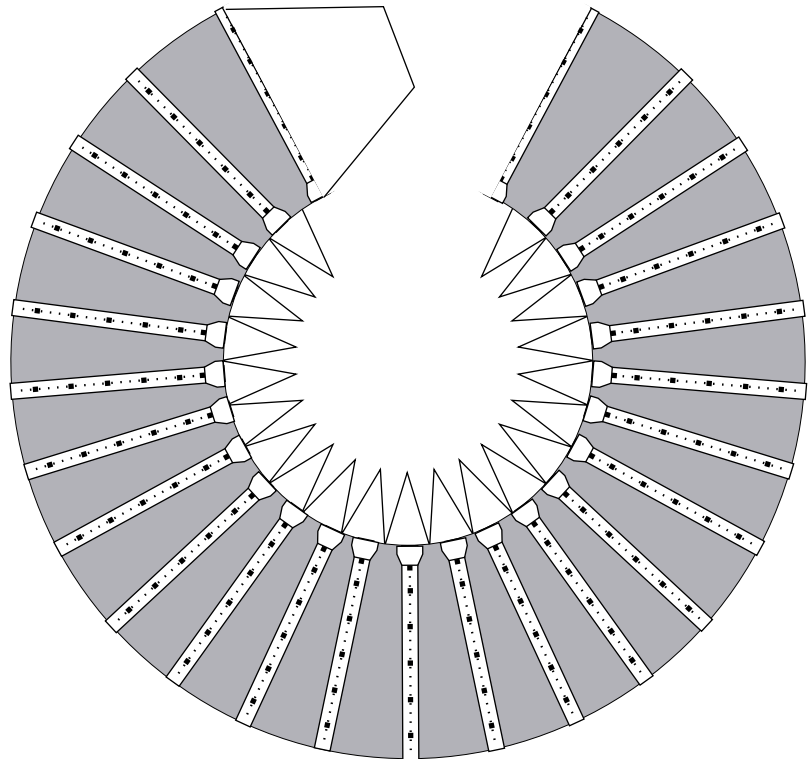
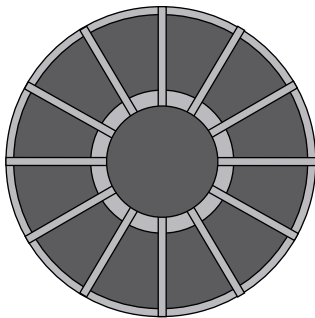
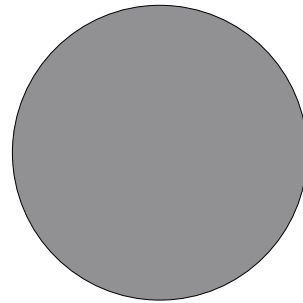
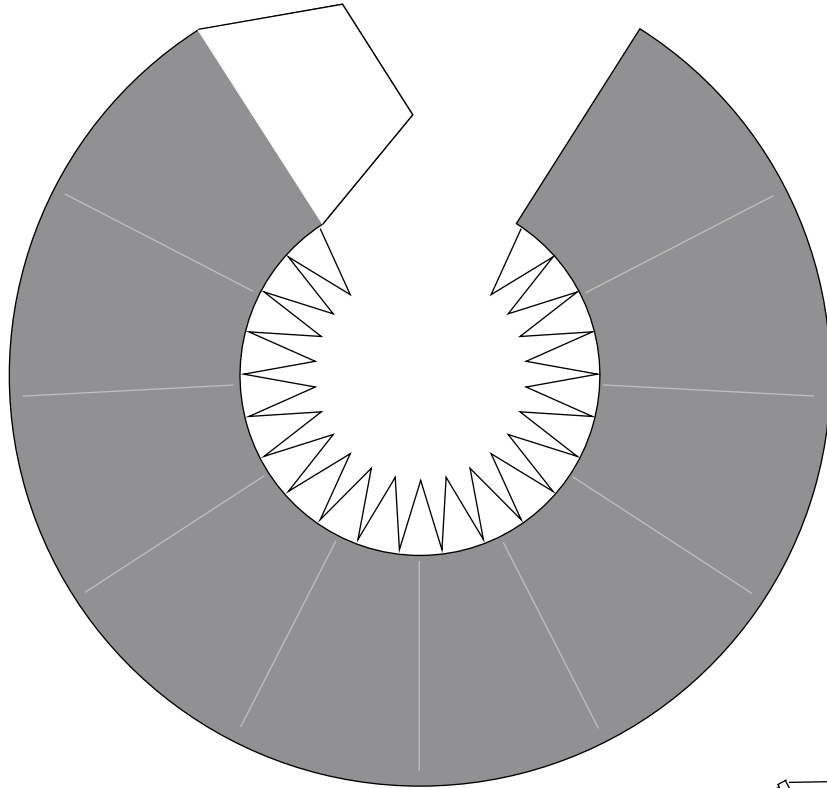



1 cm

1 inch

1:100 Scale

SpaceX SuperHeavy

Print on Cardstock (110 lbs)

Top ring

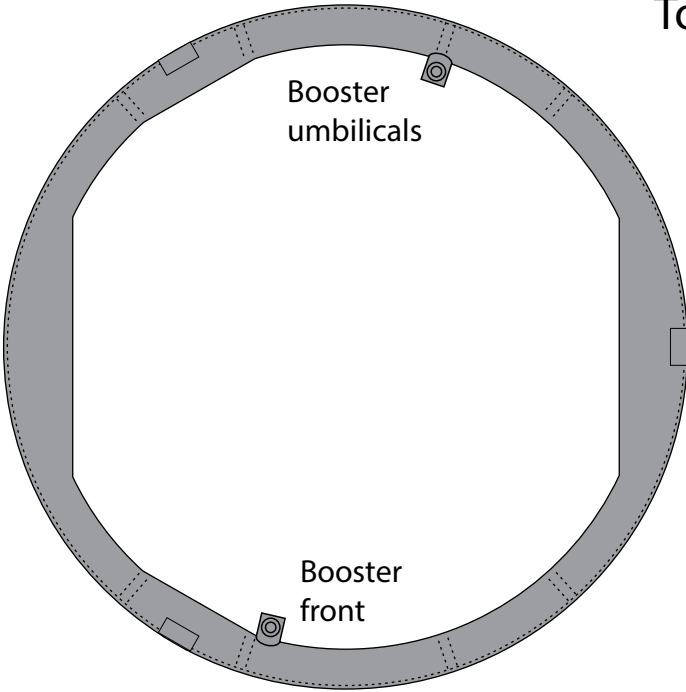

right side

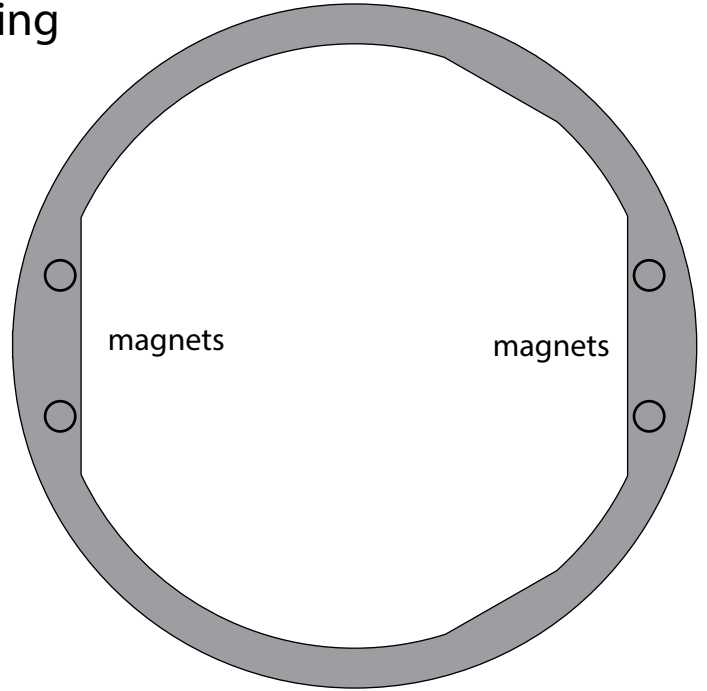

Bottom ring

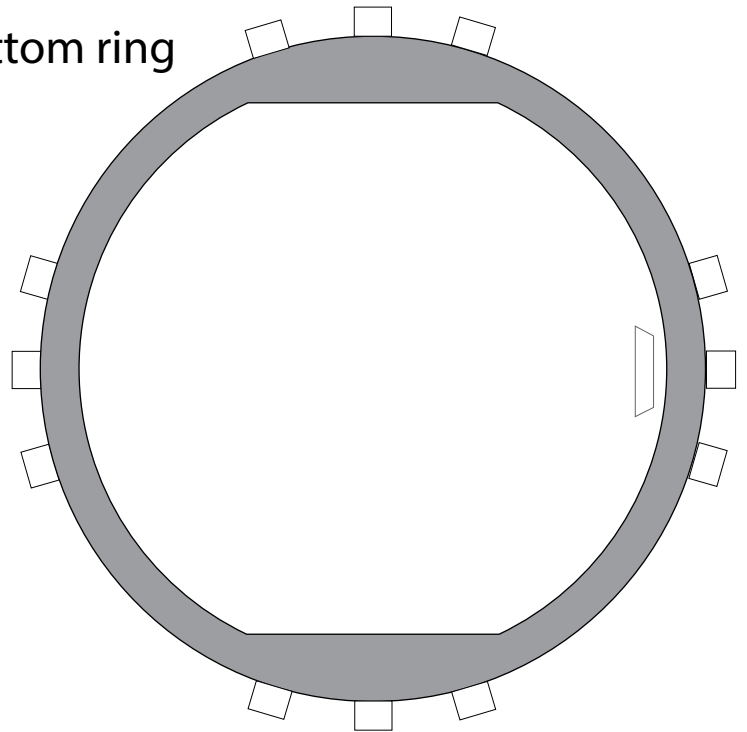
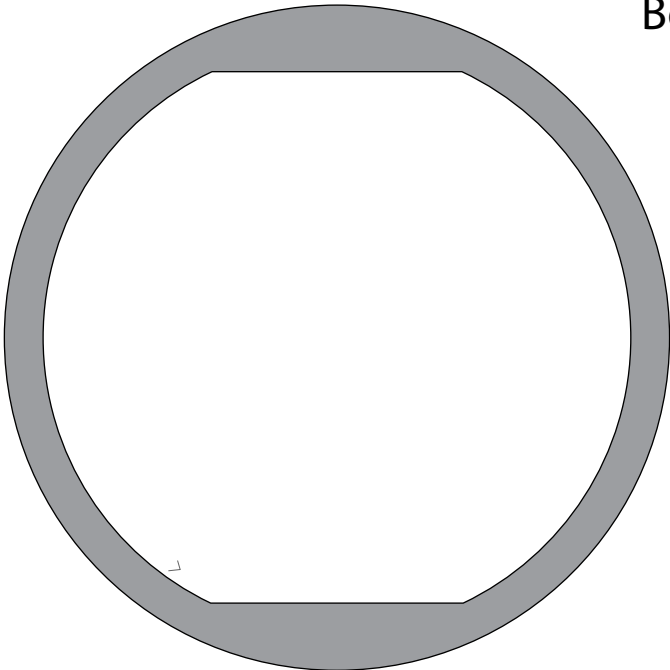



1 cm

1 inch

1:100 Scale

SuperHeavy B10 Upper Dome

Print on Cardstock (110 lbs)

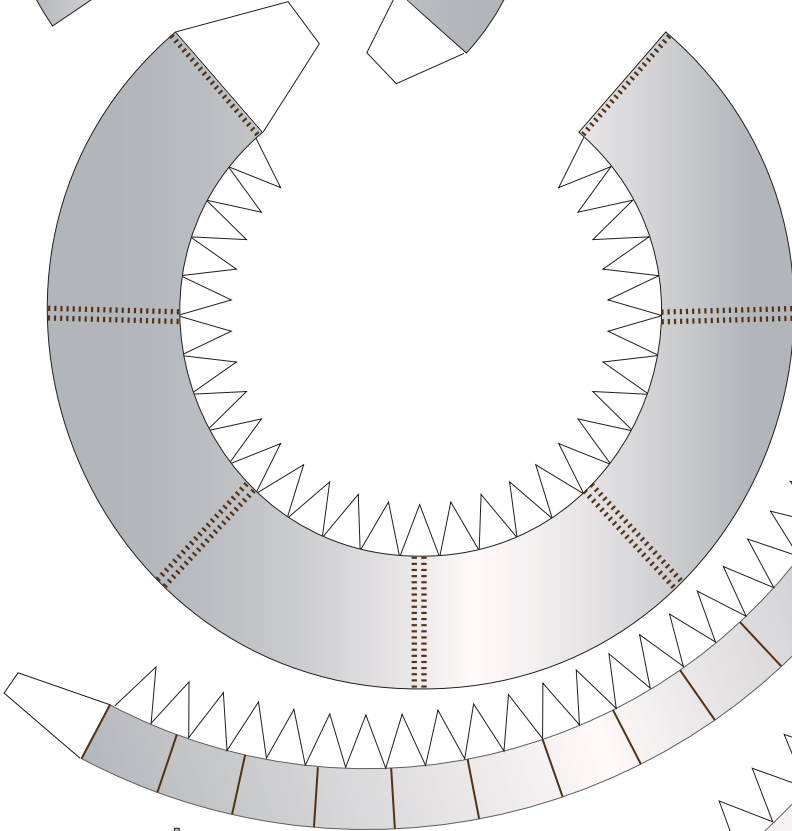
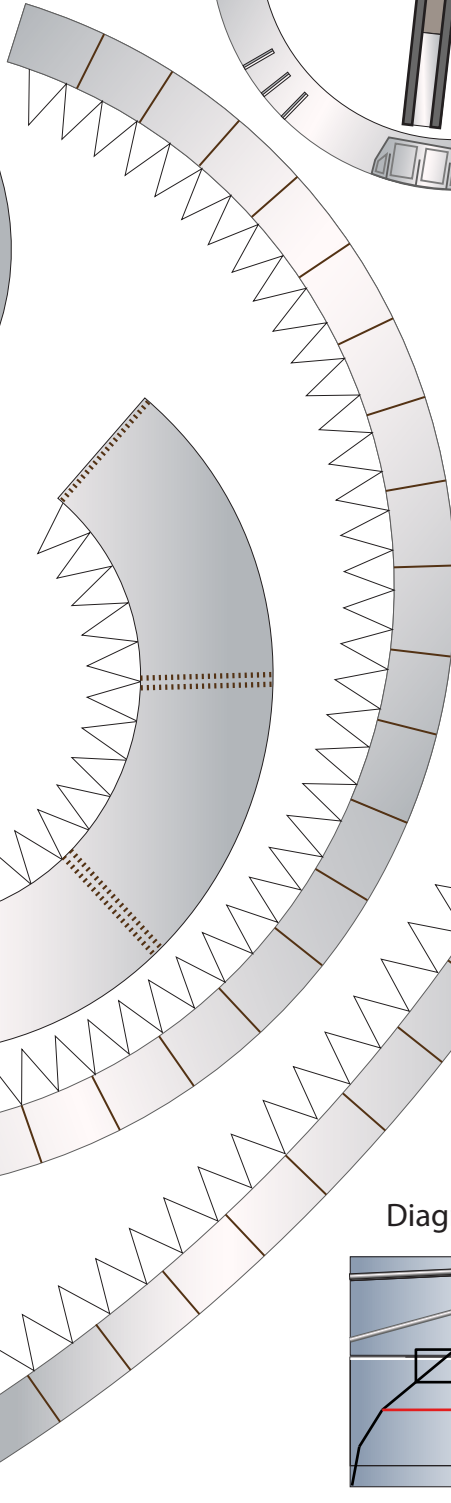
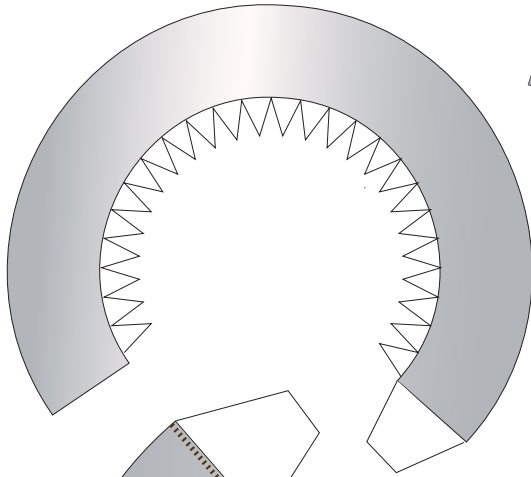
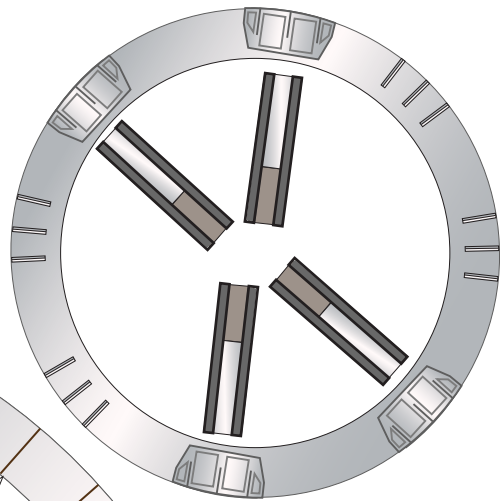
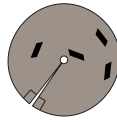
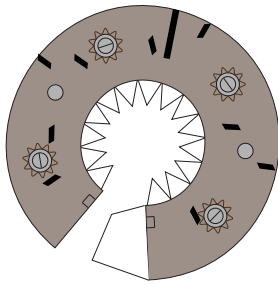

Ch4 vent pipes

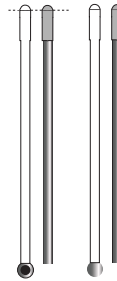

Ch4 vent pipes

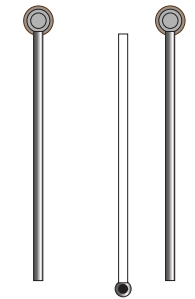
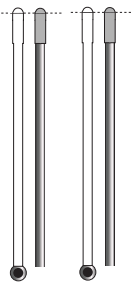

Ch4 press lines

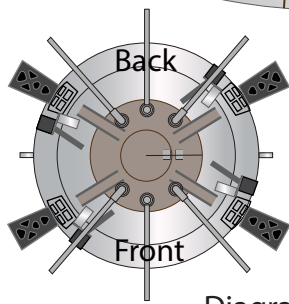

Diagram

Diagram

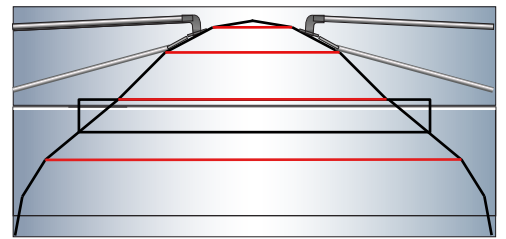



1 cm

1 inch

1:100 Scale

SpaceX Starship B10

Print on Cardstock (110 lbs)

Grid Fins servo motors and Connectors

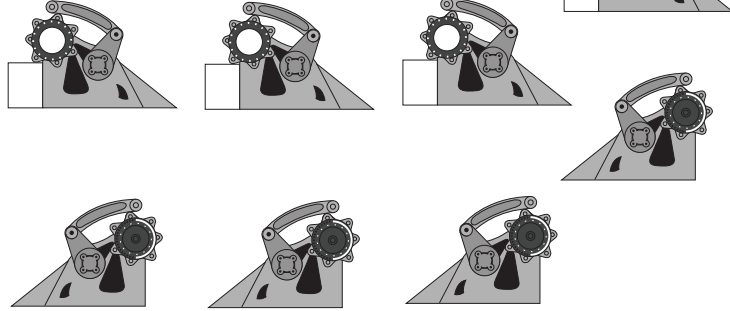
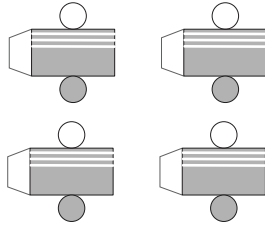
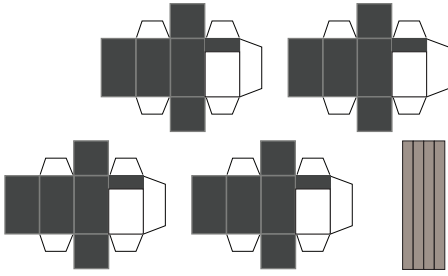

top/middle

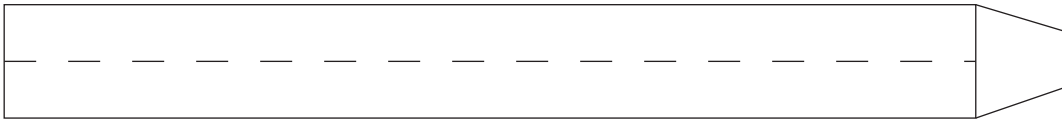
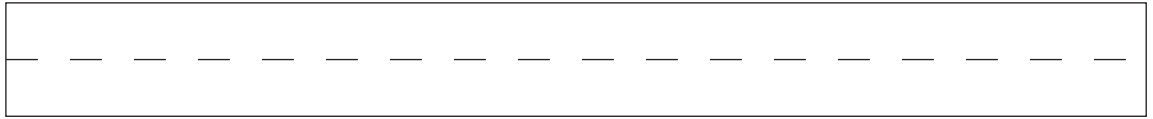

middle/bottom

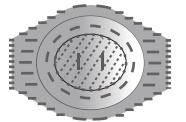
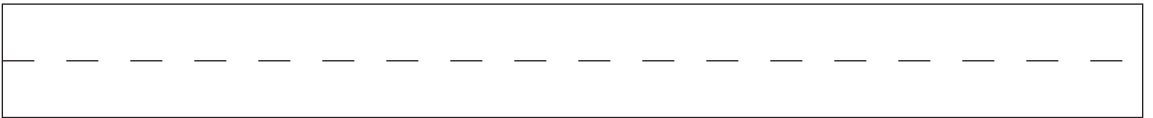

Glue tip of the
Ch4 press line to
cover the black circles

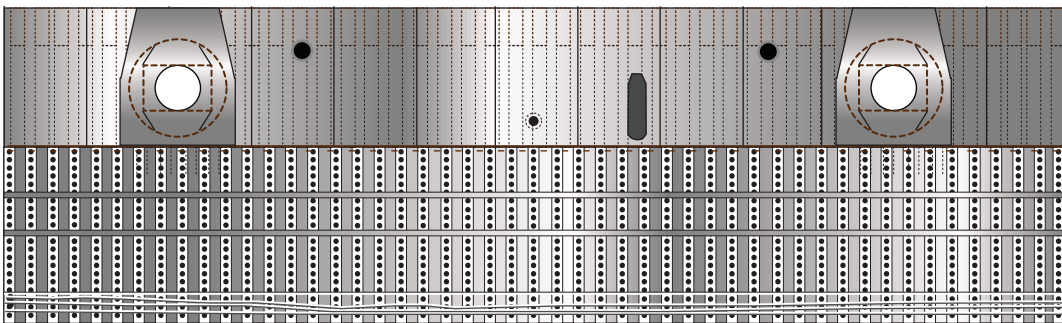
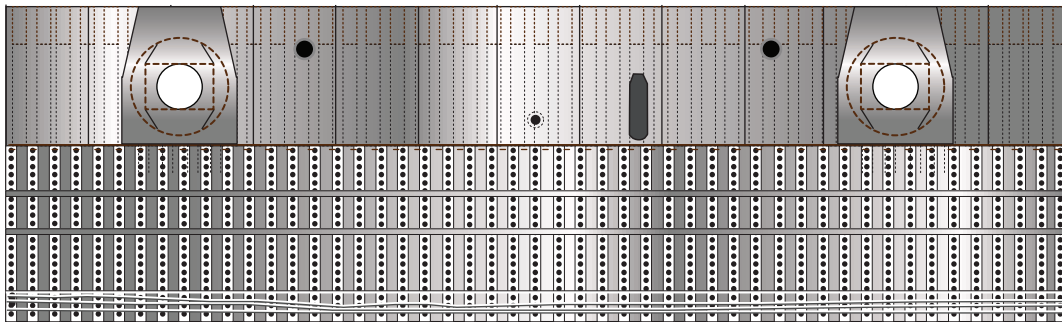

Interior wall
for upper dome
section



1 cm

1 inch

1:100 Scale

Grid Fins Simple version

Update

Print on Cardstock (110 lbs)

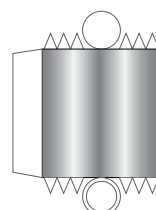
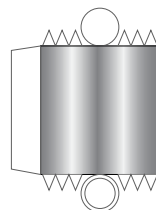
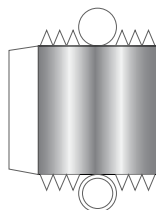
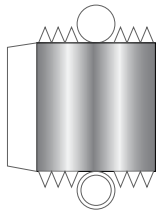
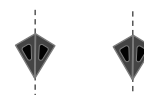
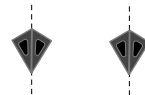
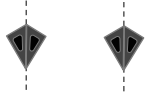
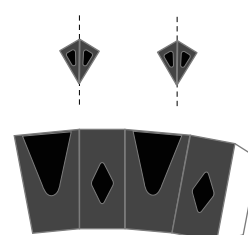
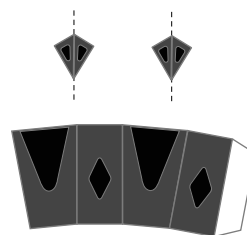
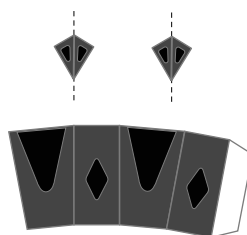
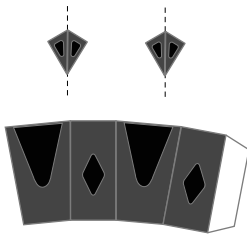
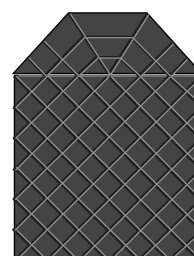
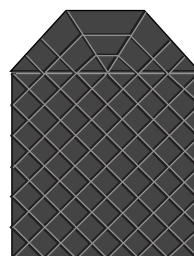
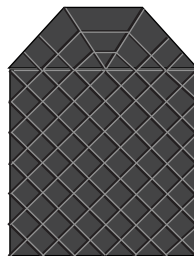
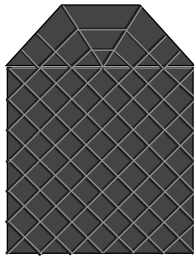
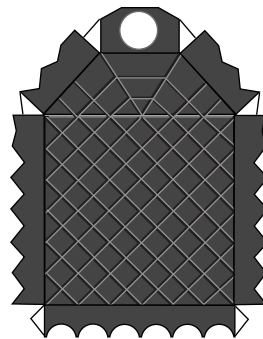
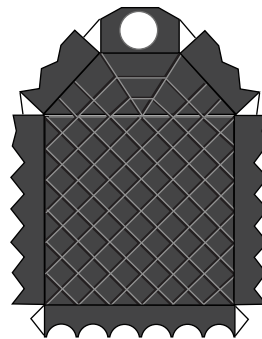
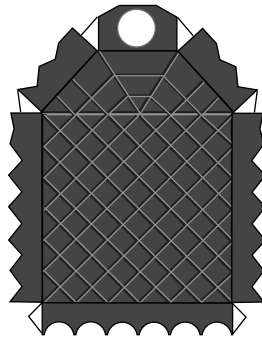
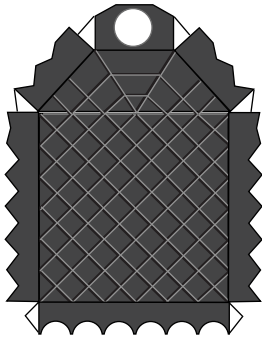



1 cm

1 inch

1:100 Scale

B10 Grid Fins

Back Print

Print on Cardstock (110 lbs)





1 cm

1 inch

1:100 Scale

Grid Fins Detailed version

Print on Cardstock (110 lbs)

Update

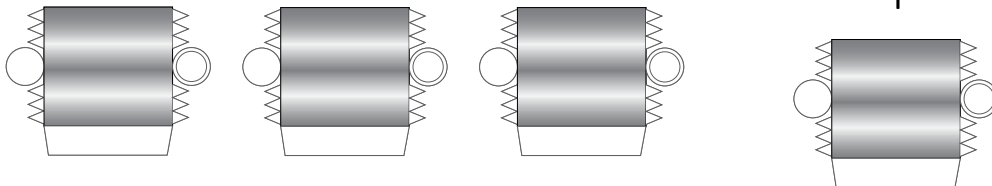
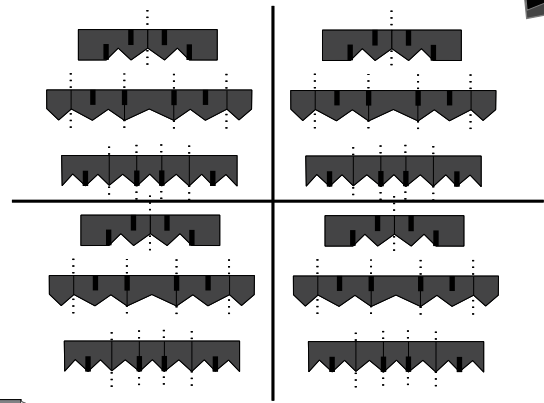
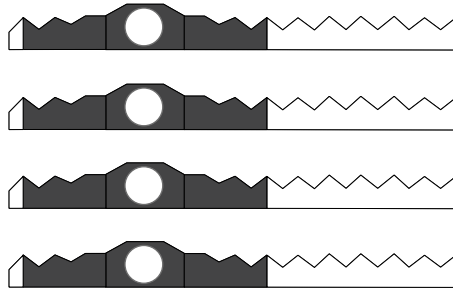
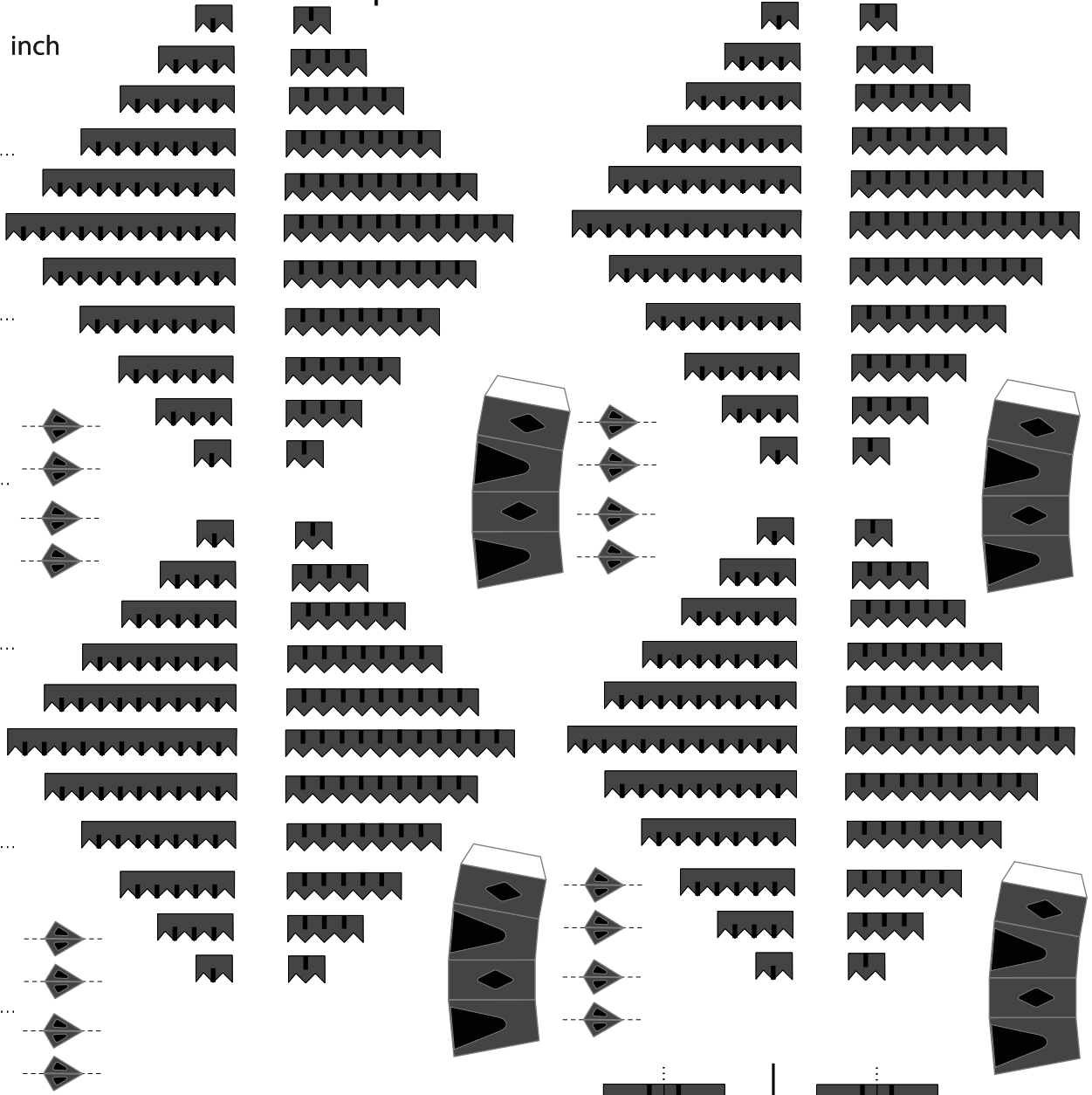
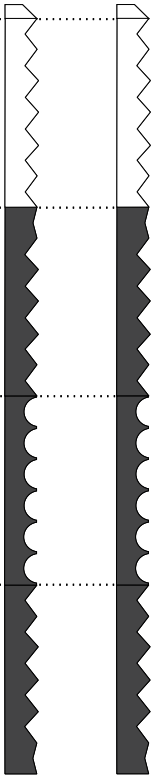



B10 Grid Fins back print

Print on Cardstock (110 lbs)

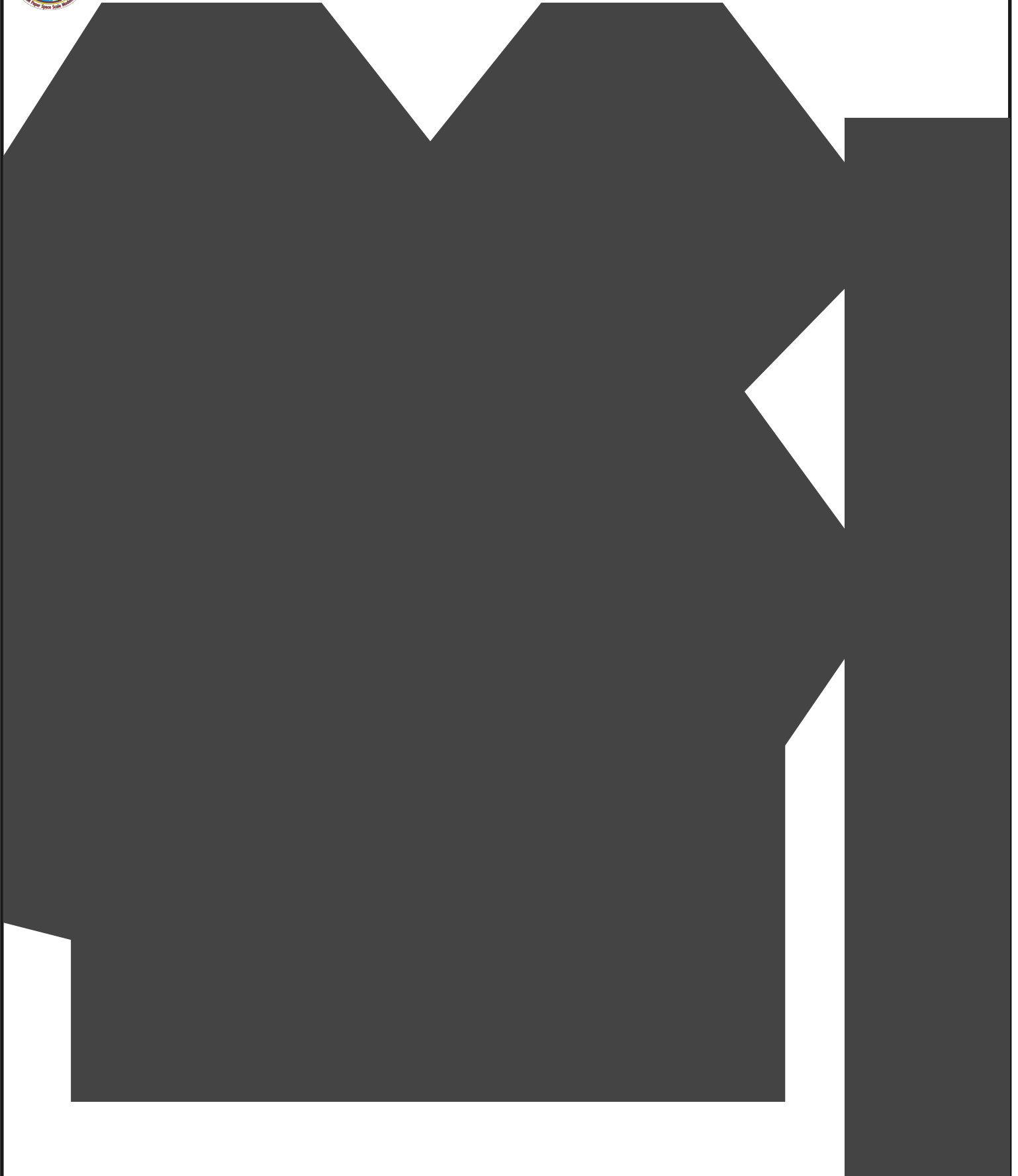



1:100 Scale



Booster 10

Print on Cardstock (110 lbs)

Belly side top

Revised

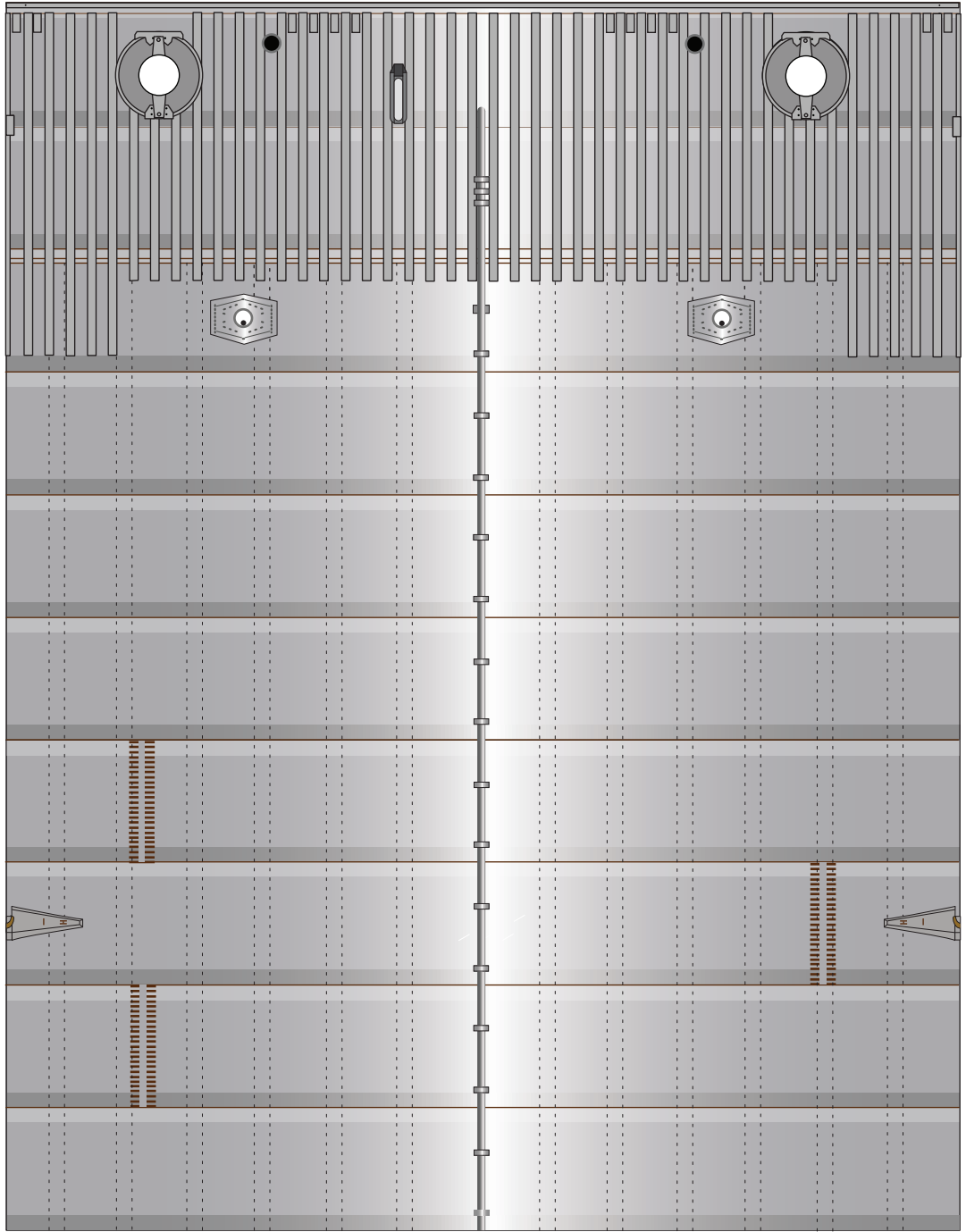
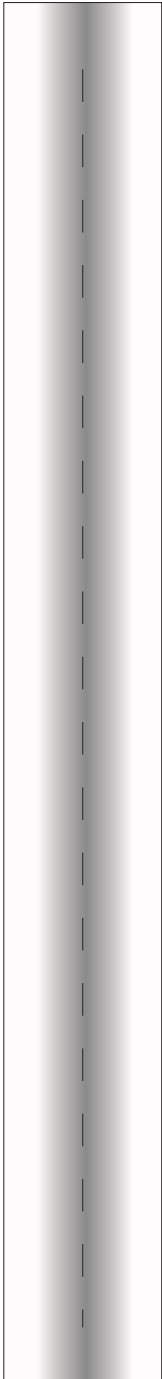
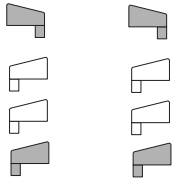



1:100 Scale



Booster 10

Print on Cardstock (110 lbs)

Back side top

Revised

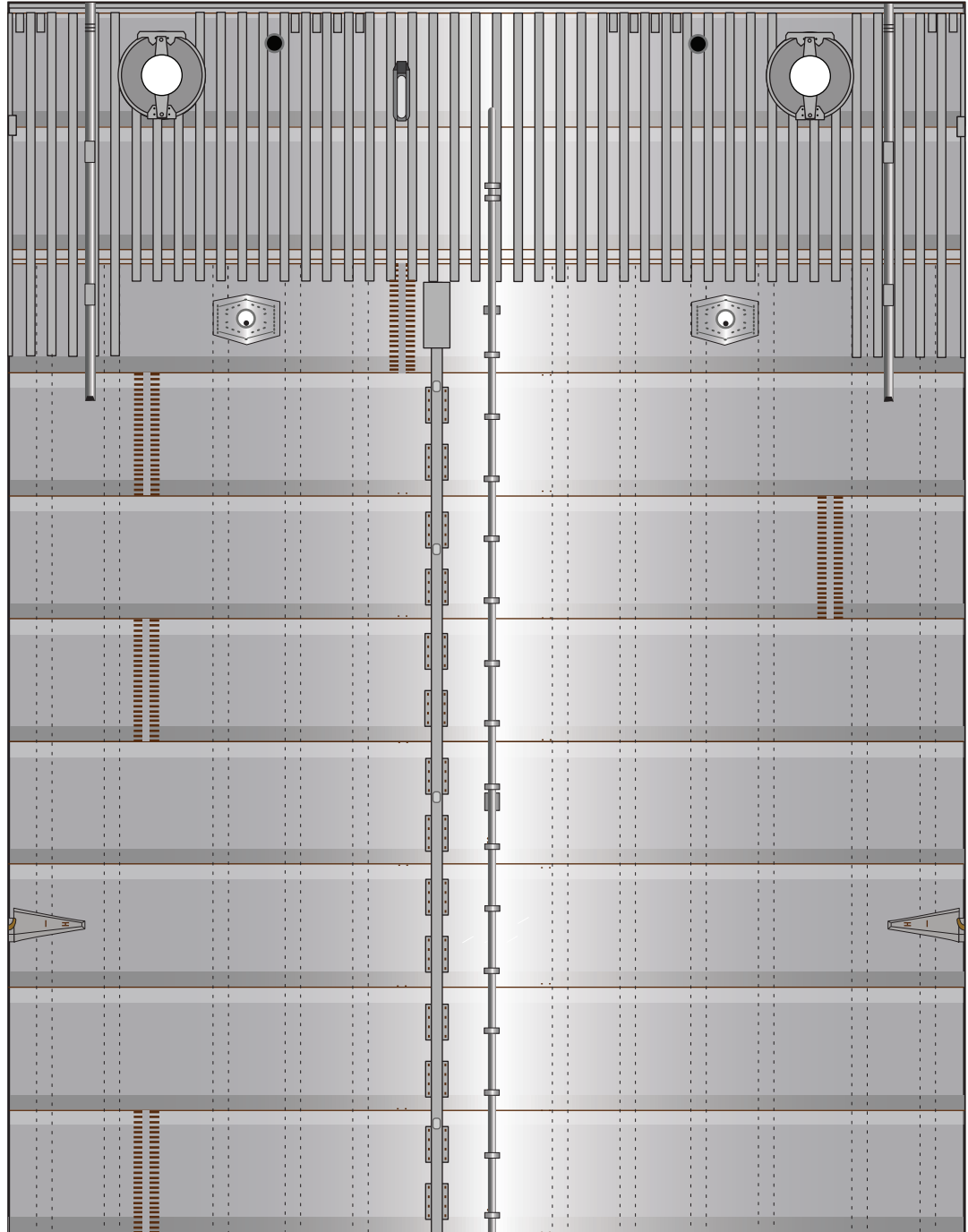
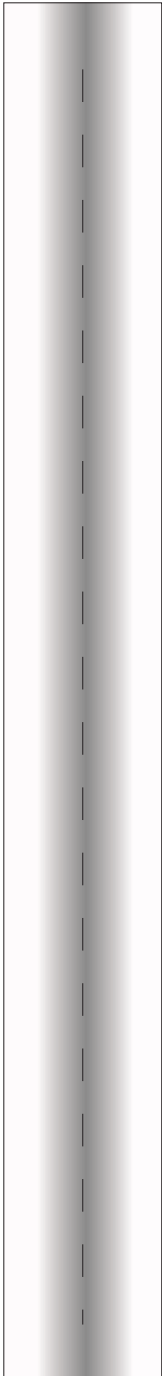



1:100 Scale

Booster 10

Print on Cardstock (110 lbs)
Belly side middle

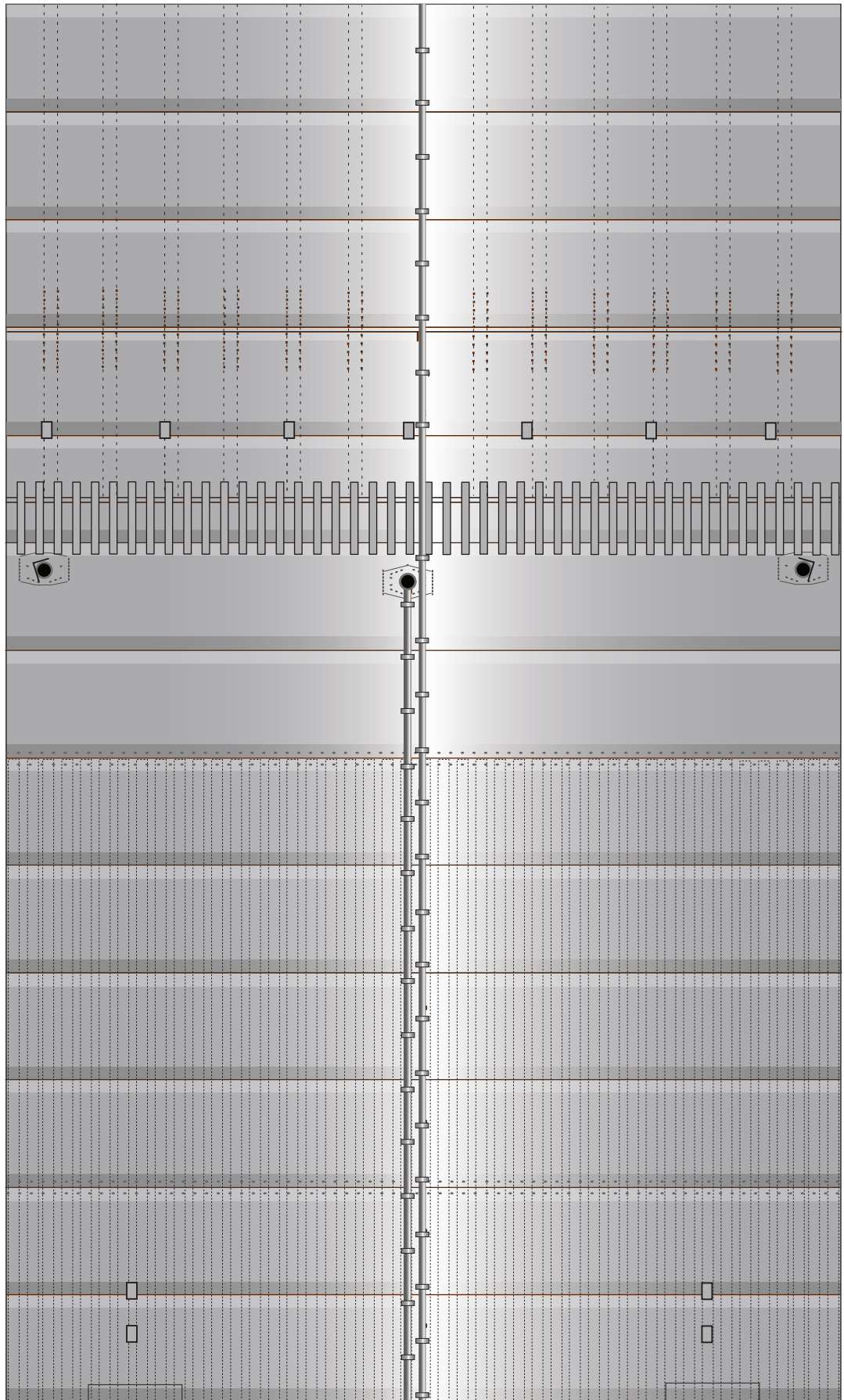
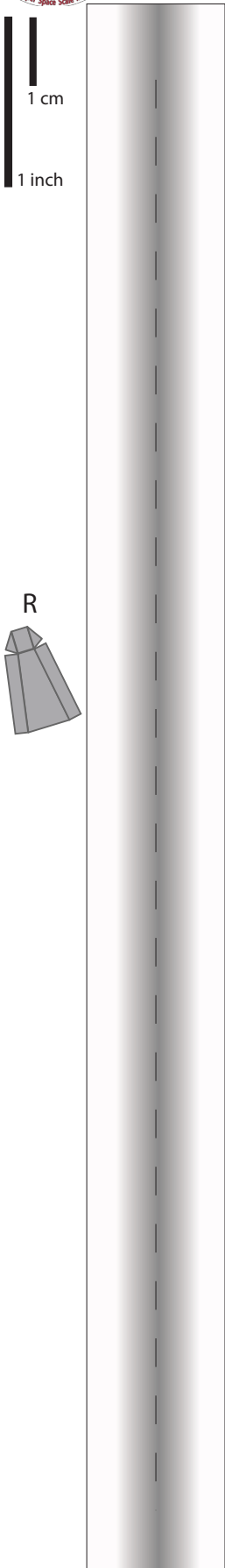



1:100 Scale

Booster 10

Print on Cardstock (110 lbs)
Back side middle

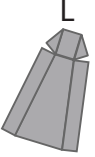
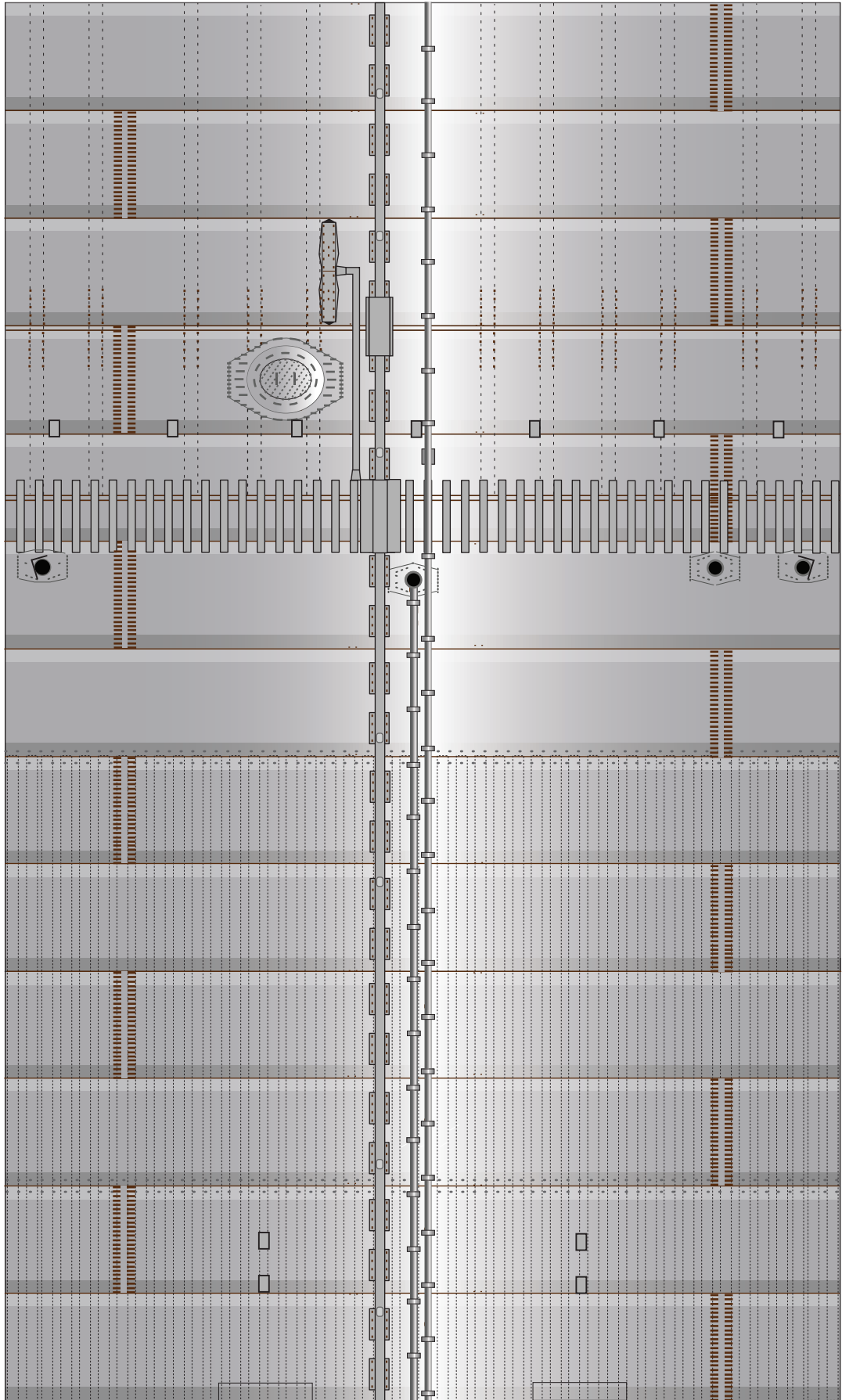
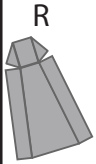



1:100 Scale

Booster 10

Print on Cardstock (110 lbs)

Belly side bottom

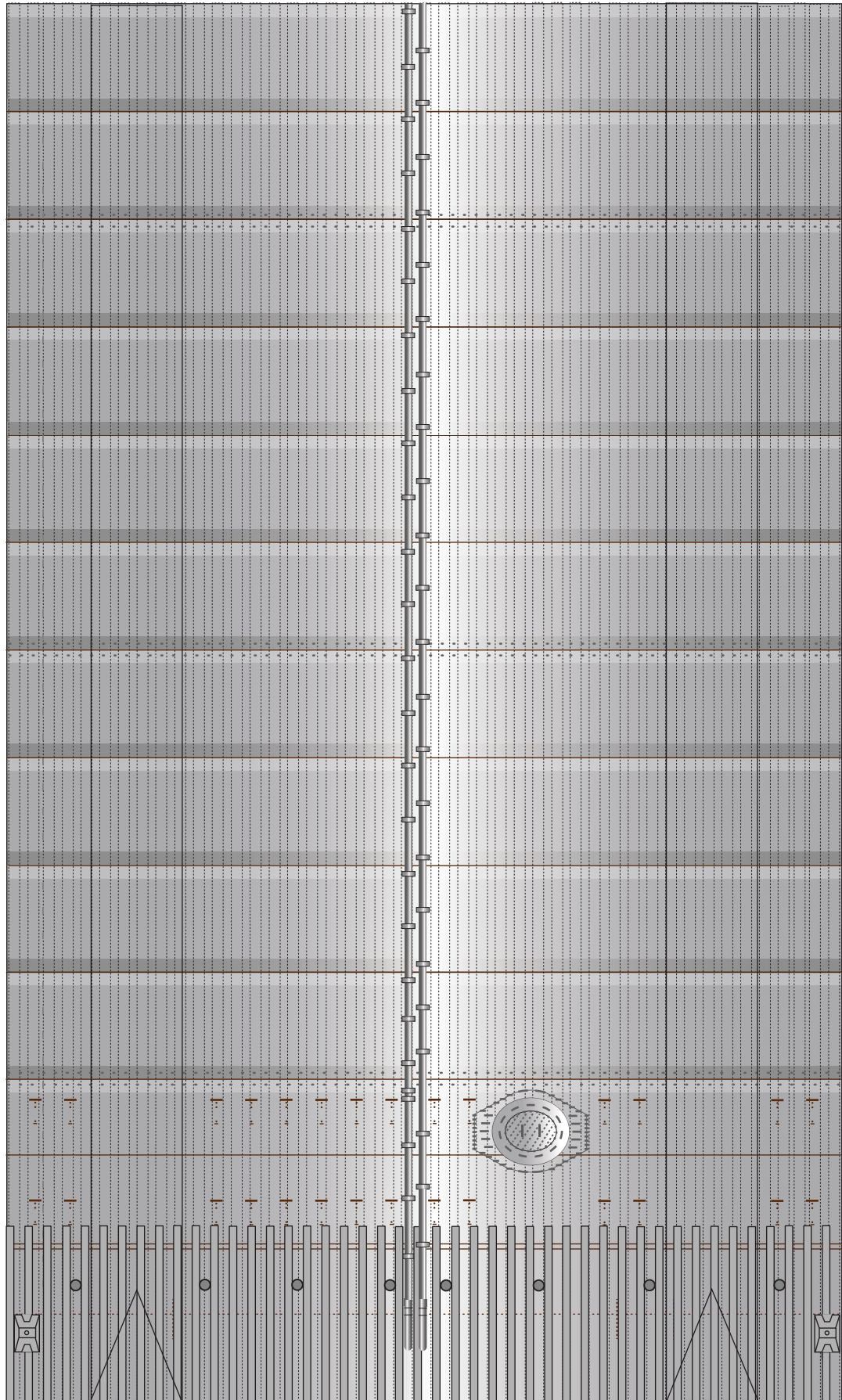
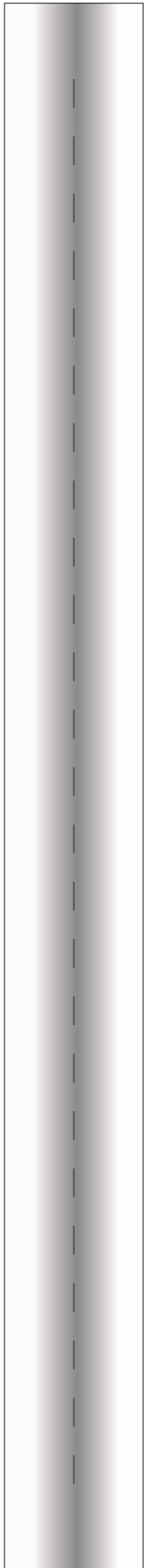



1:100 Scale

Revised

Booster 10

Print on Cardstock (110 lbs)
Back side bottom

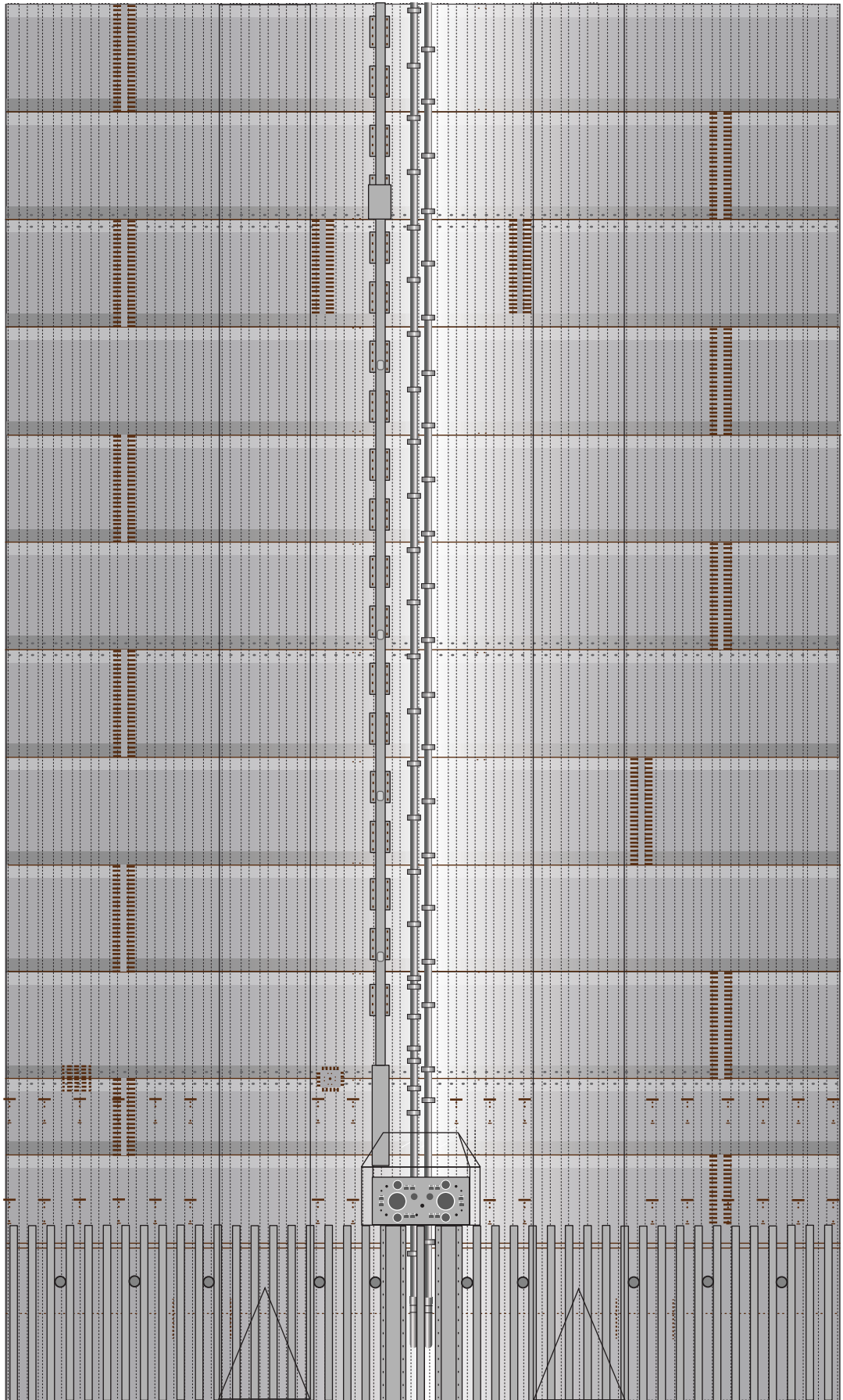
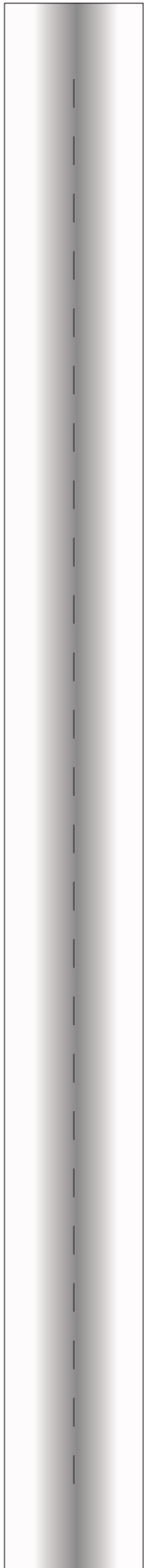



1:100 Scale



SpaceX Heavy booster 10

Print on cardstock (110 lbs)

COPV covers

FRONT

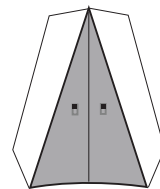
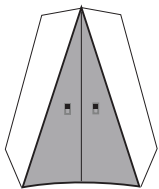
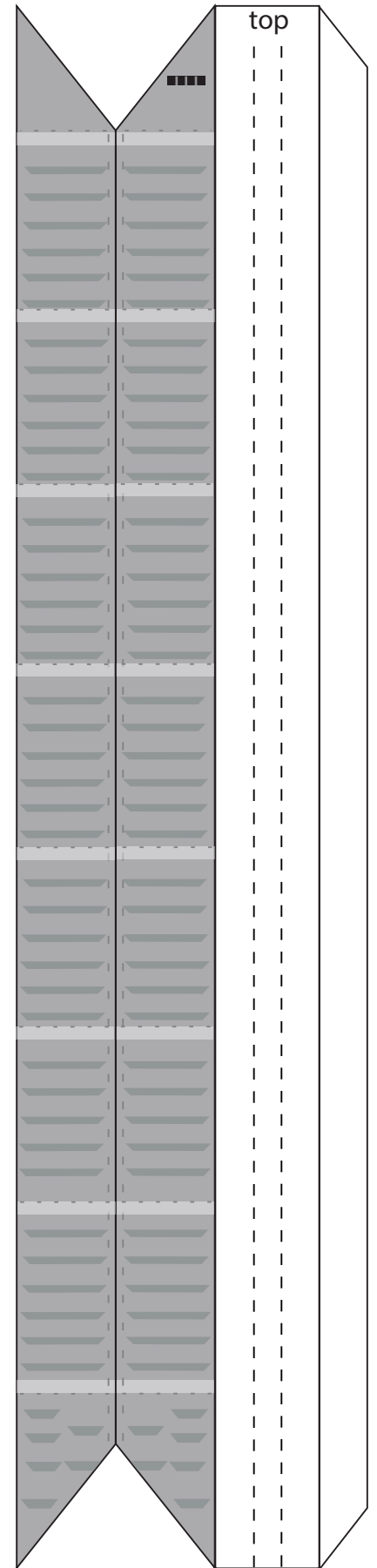
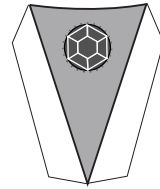
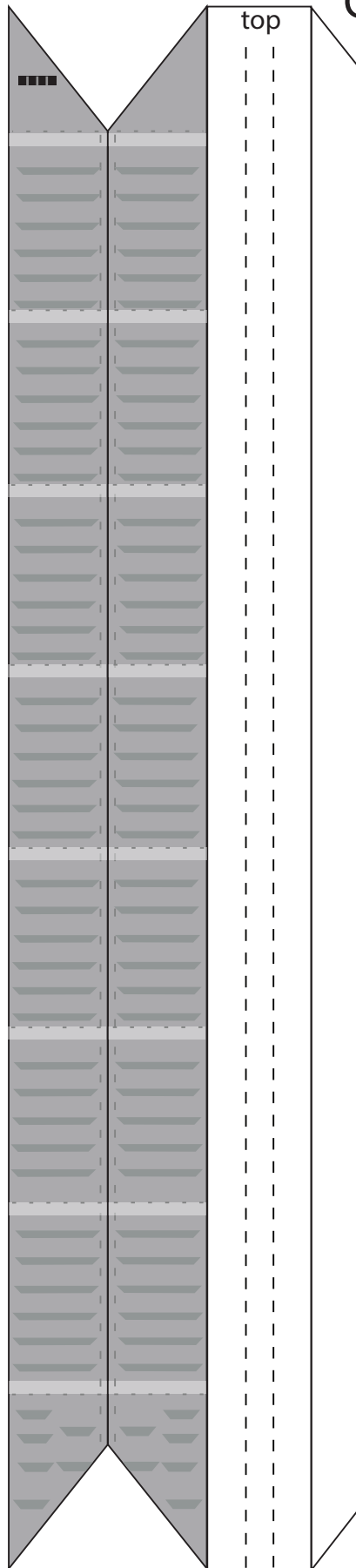
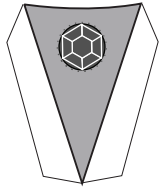



1:100 Scale



SpaceX Heavy booster 10

Print on cardstock (110 lbs)

COPV covers

Umbilical side

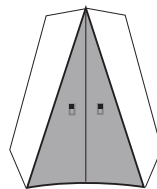
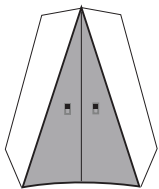
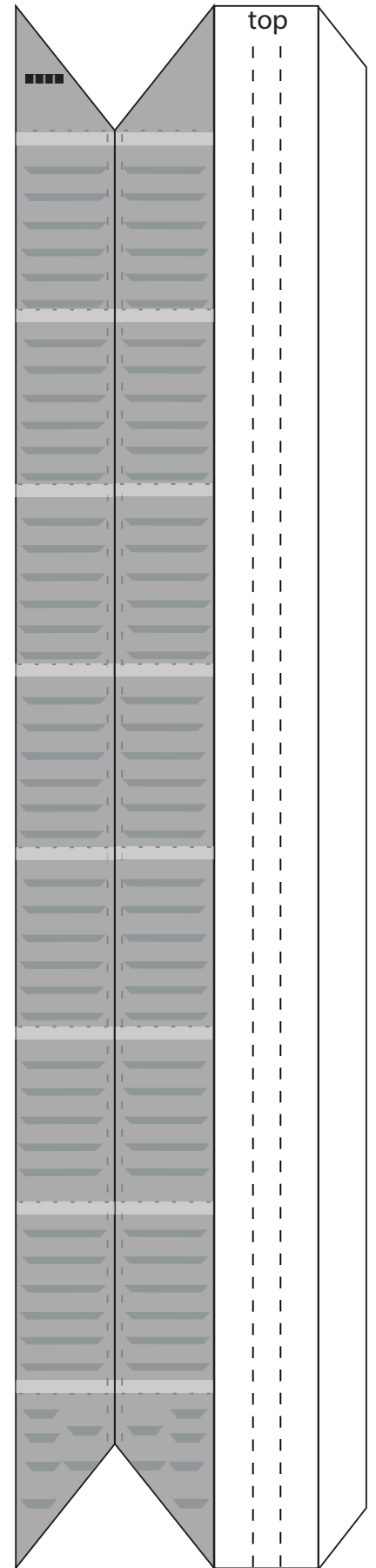
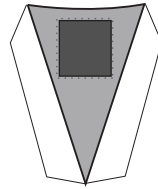
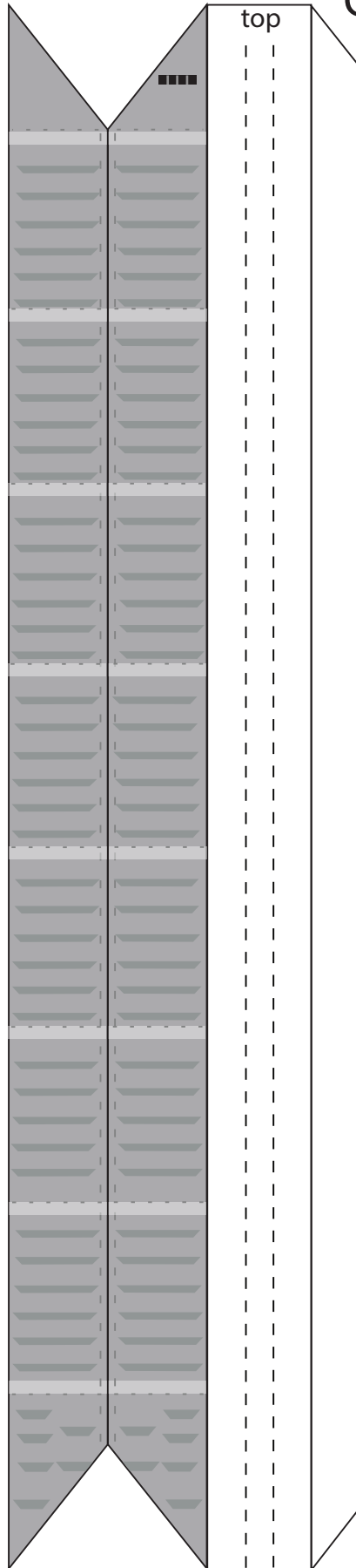
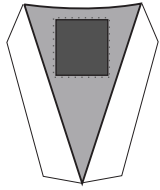



1:100 Scale



SpaceX Starship B10

Formers for top section

Print on Cardstock (110 lbs)

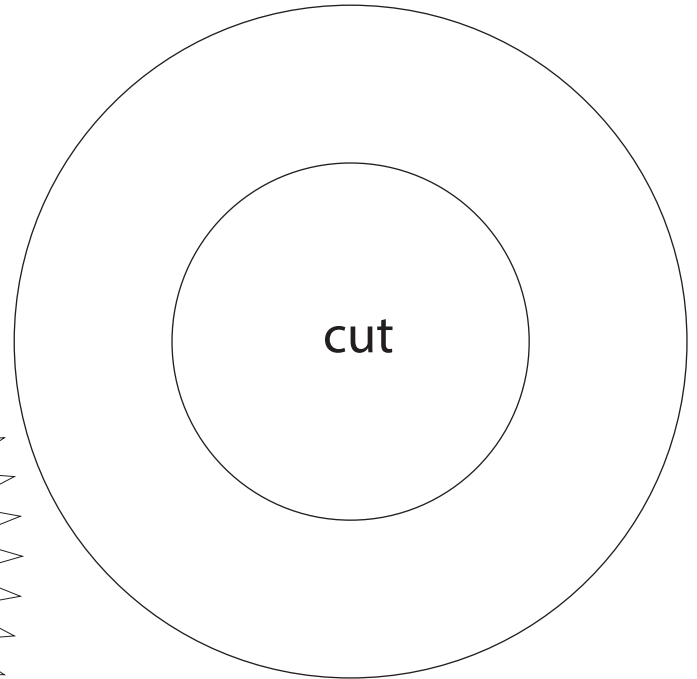
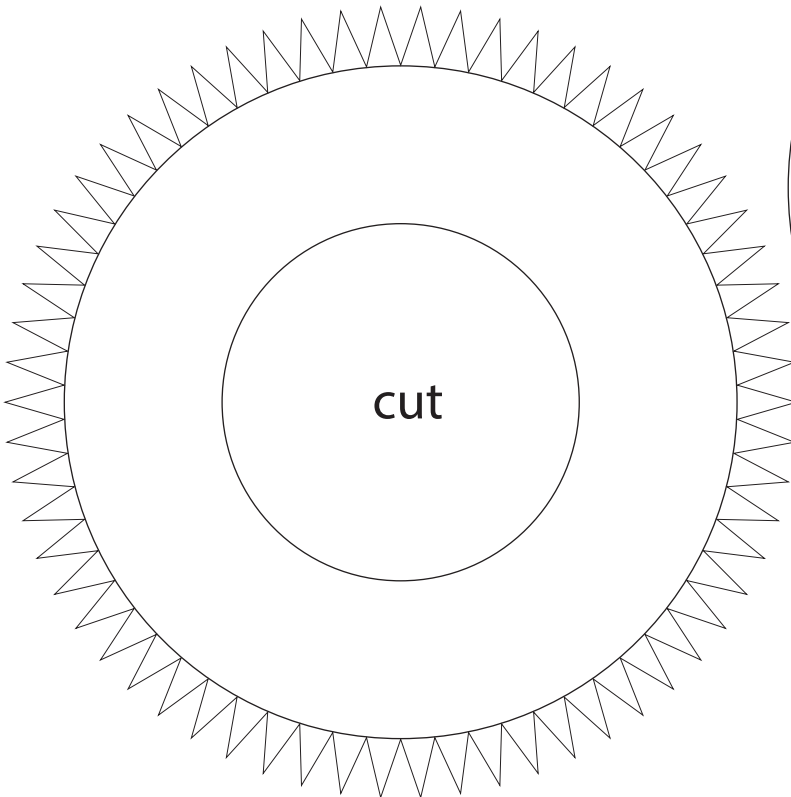
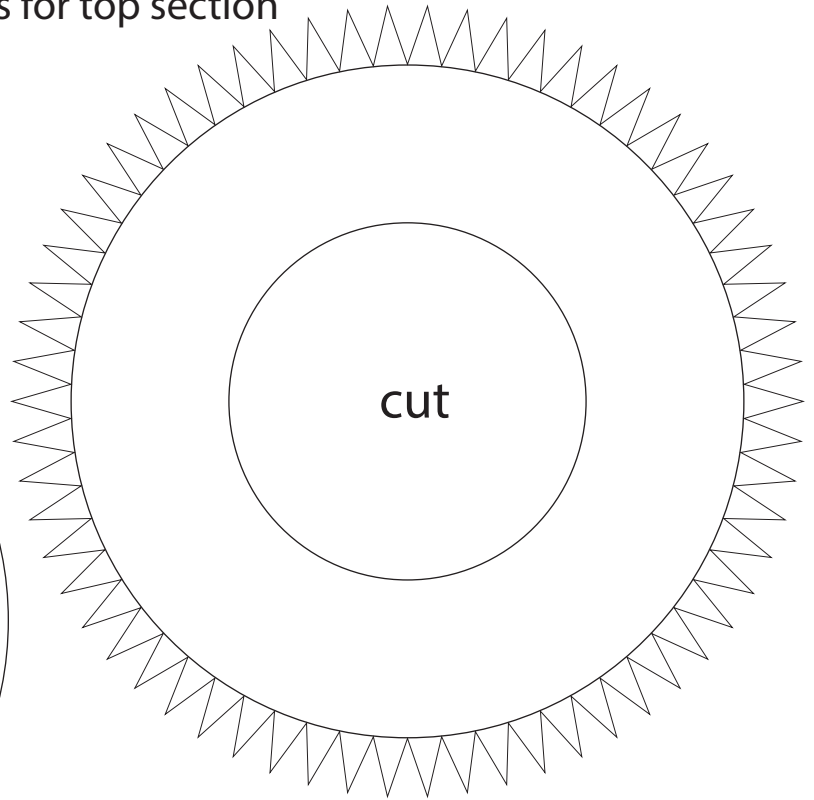
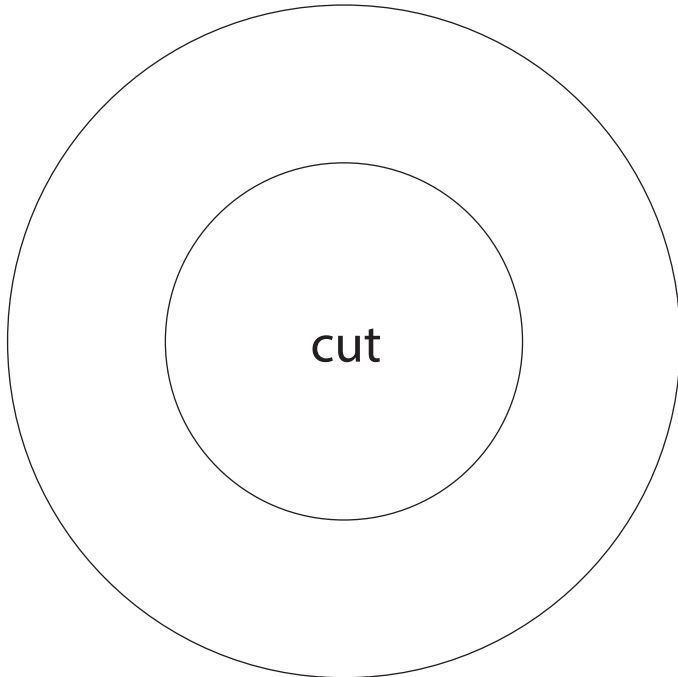

IMPORTANT
Top former is glued 42 mm from top edge of top booster section.
Bottom former is glued 20 mm from bottom edge of top booster section.



1:100 Scale



SpaceX Starship B10

Print on Cardstock (110 lbs)

Formers for middle body

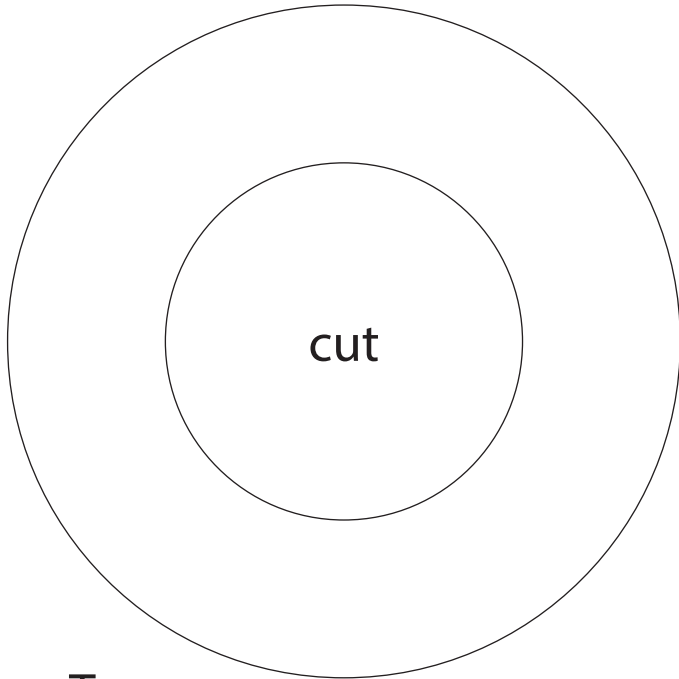

Top

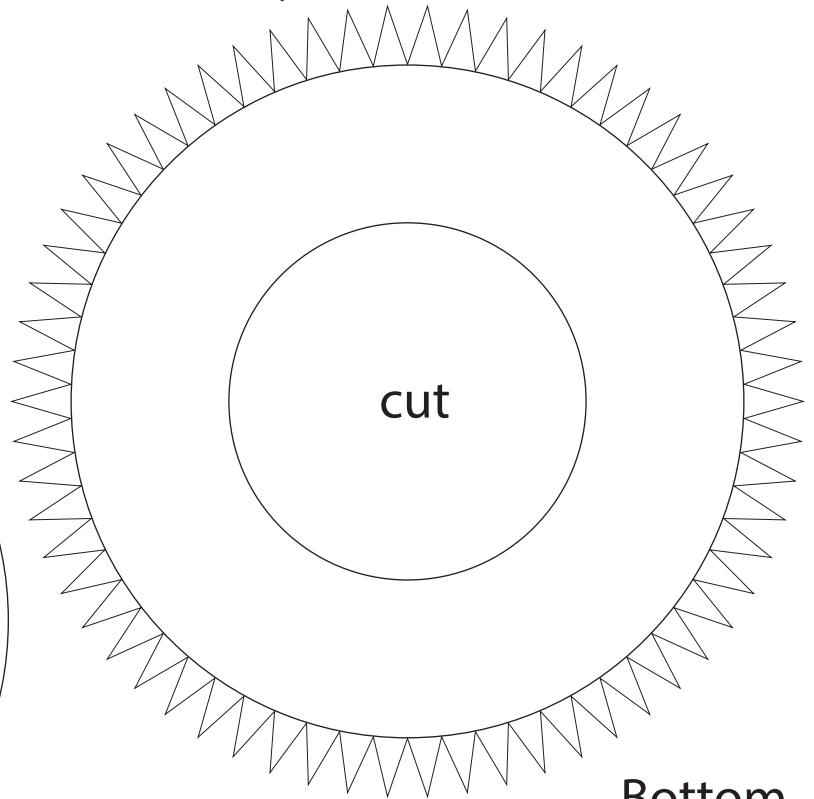

Bottom

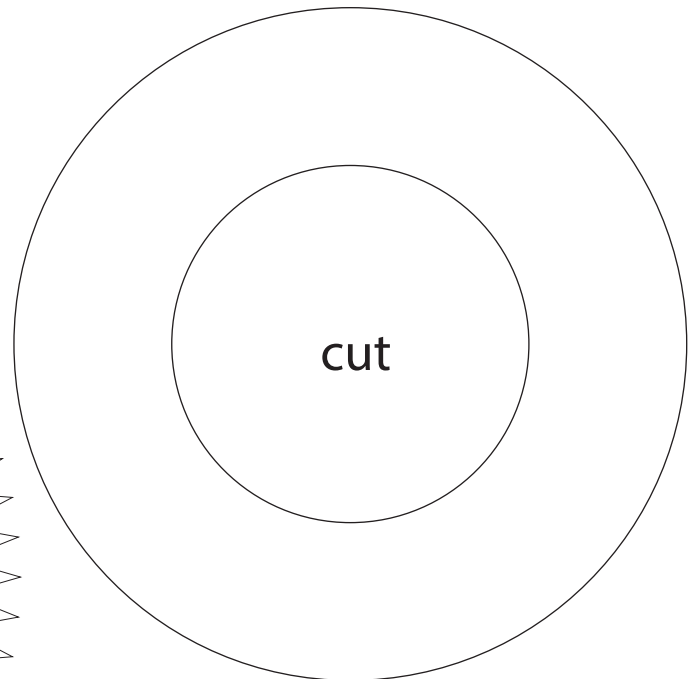
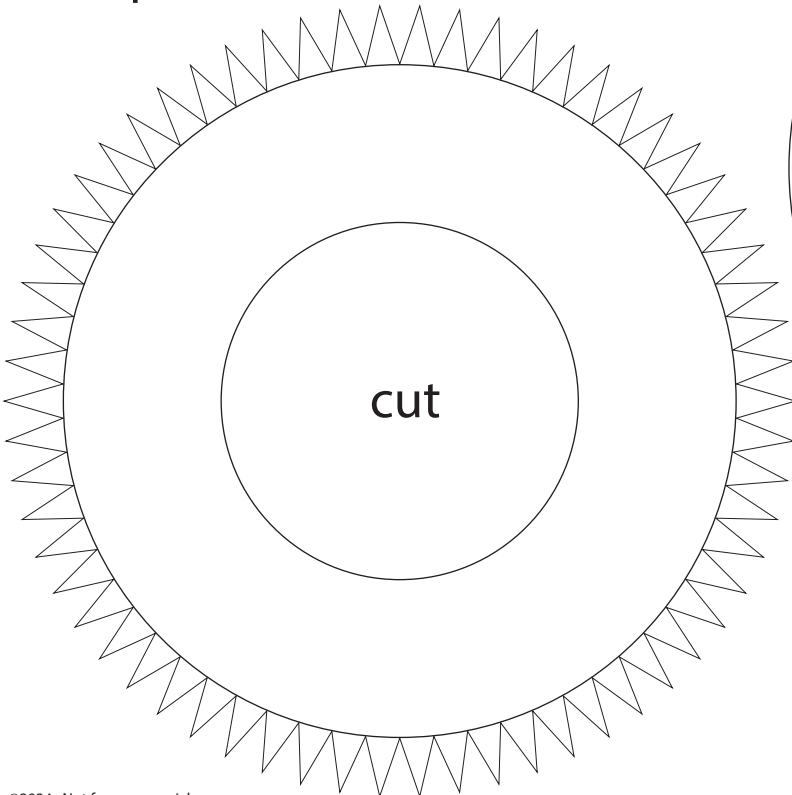

IMPORTANT

Top former is glued 20 mm from top edge of middle booster section.
Bottom former is glued 20 mm from bottom edge of middle booster section.



1:100 Scale

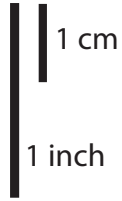

SpaceX Starship B10

Print on Cardstock (110 lbs)

Formers for bottom body

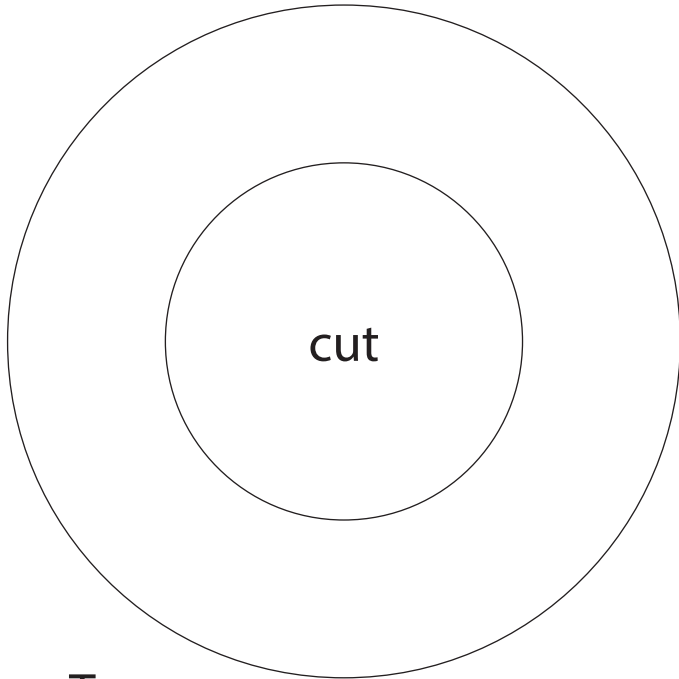

Top

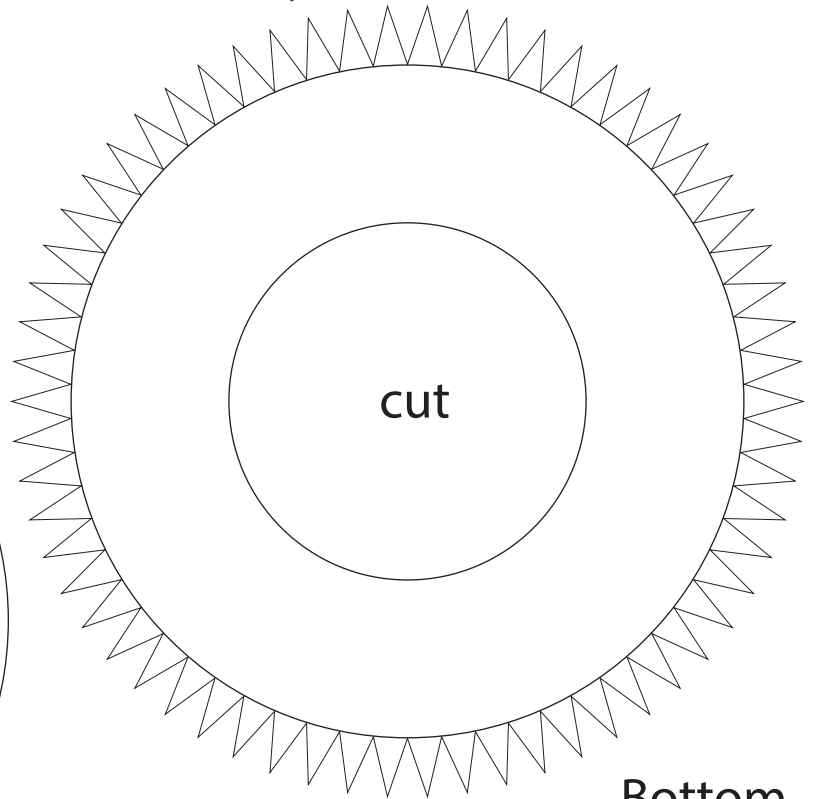

Bottom

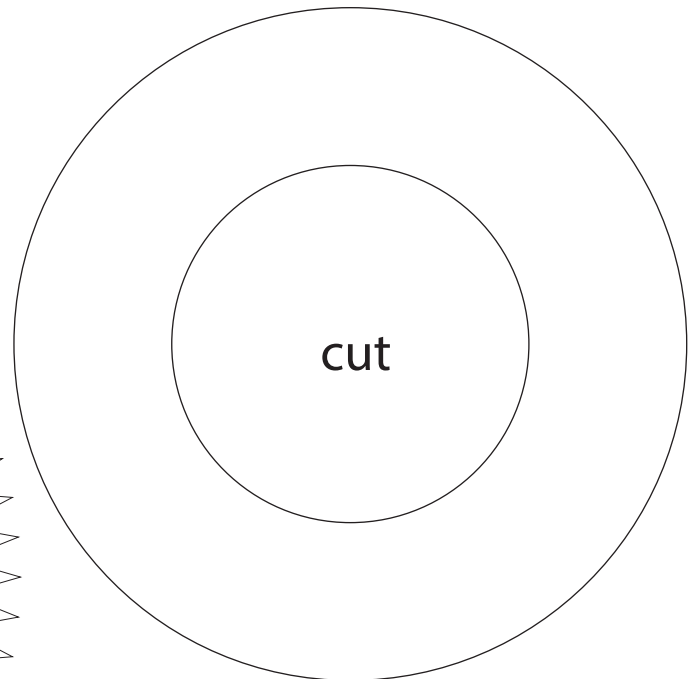
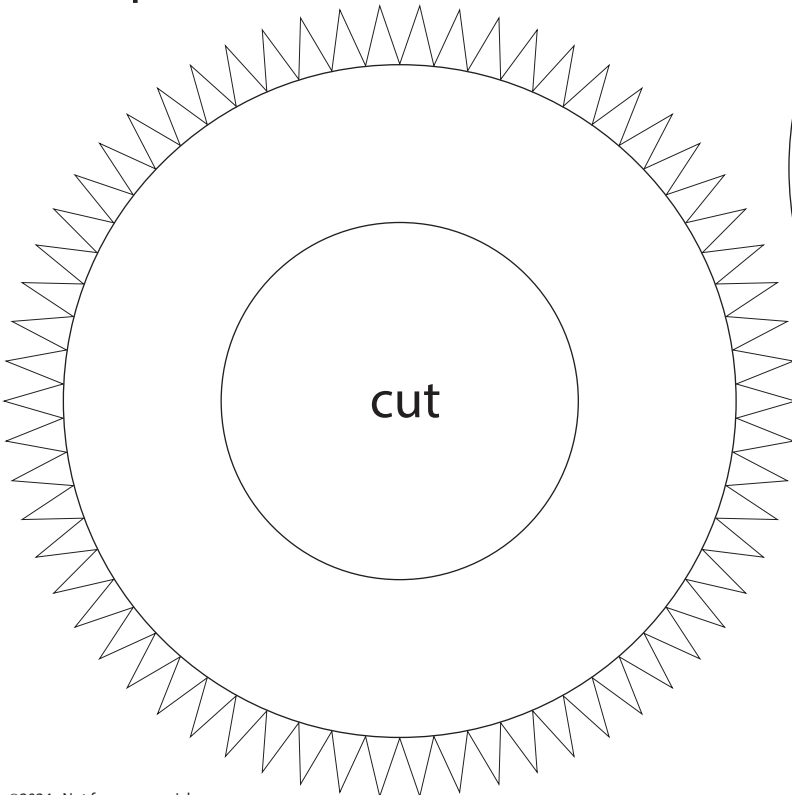

IMPORTANT

Top former is glued 20 mm from top edge of bottom booster section. Bottom former is glued 19 mm from bottom edge of bottom booster section.



1 cm

1 inch

1:100 Scale

SpaceX SuperHeavy

Print on Cardstock (110 lbs)

Outer Raptor ring

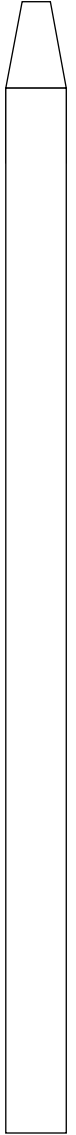
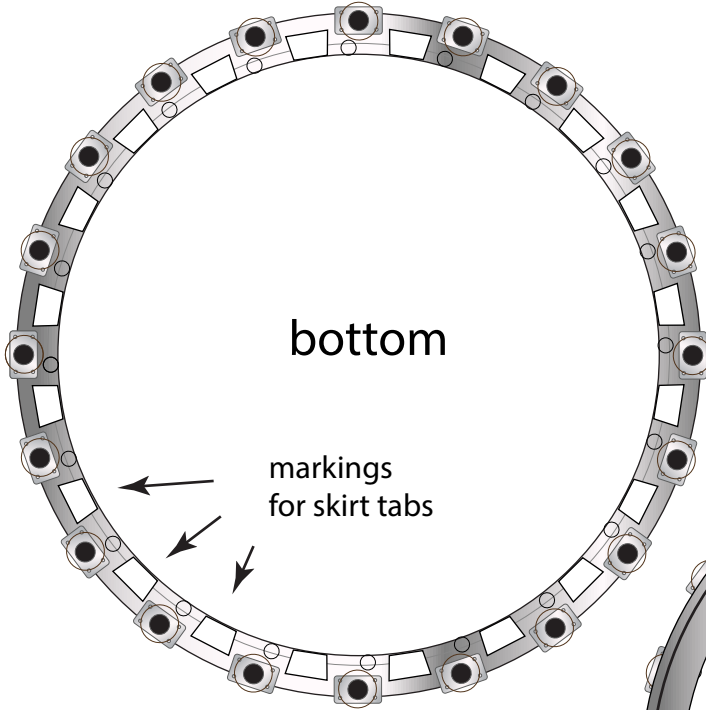

Engine section interior layer





1 cm

1 inch

1:100 Scale

SpaceX Heavy Booster 10

Print on Cardstock (90 lbs)

Skirt for engine section

Revised

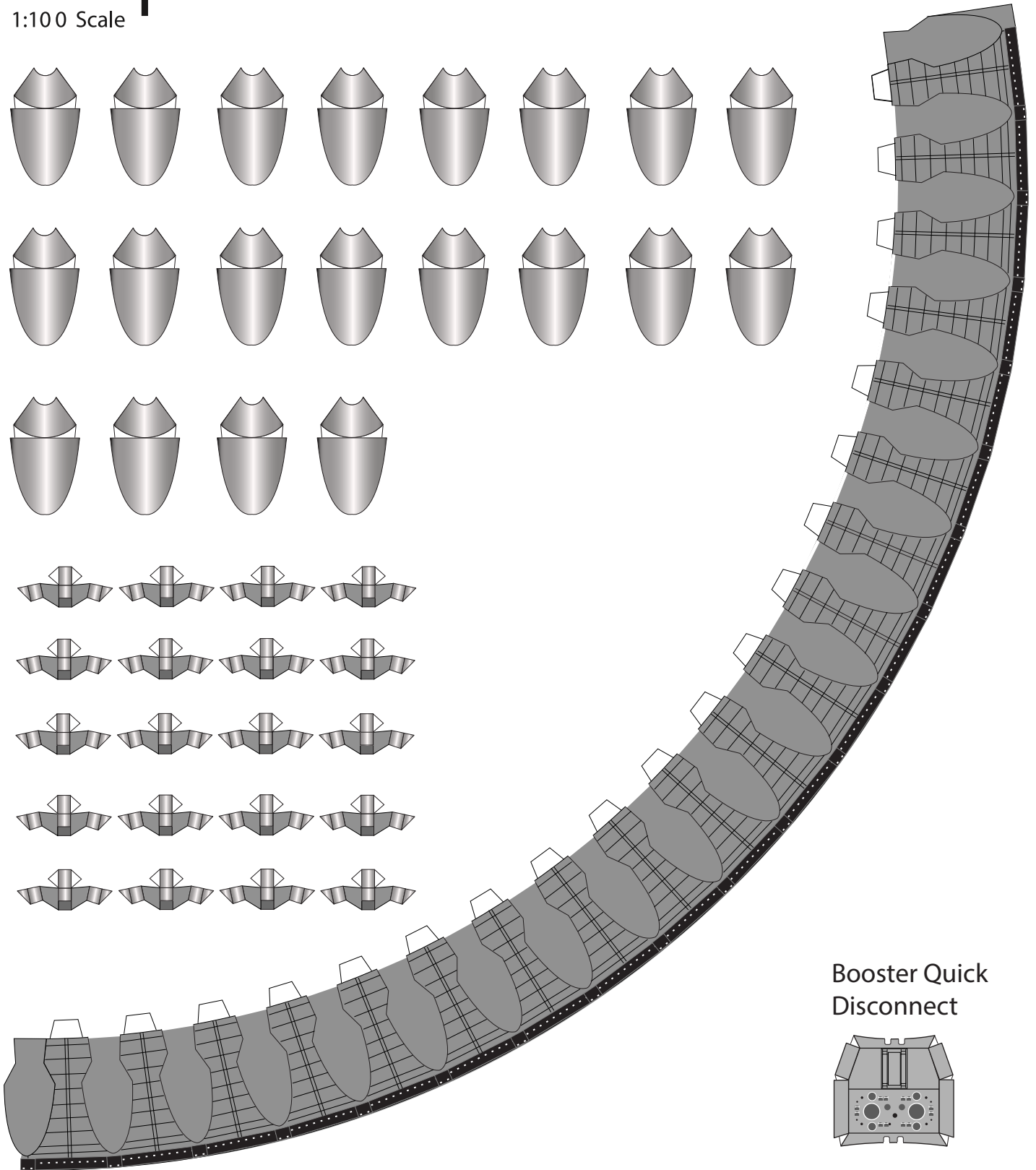
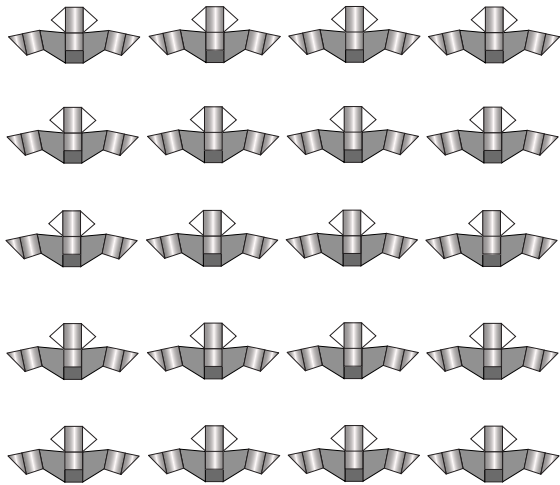
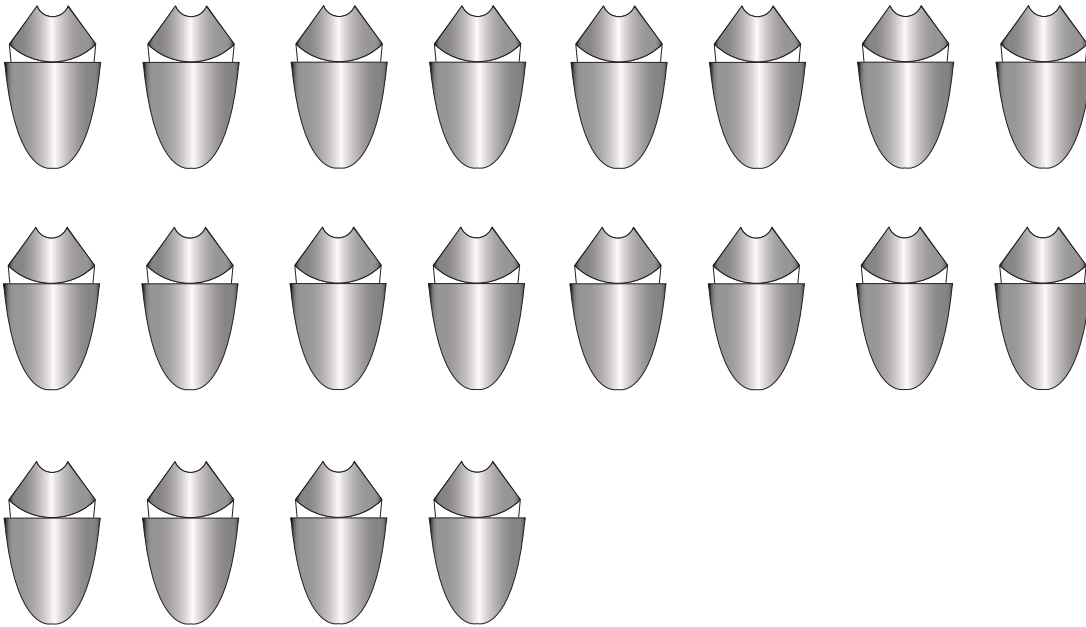

Booster Quick Disconnect

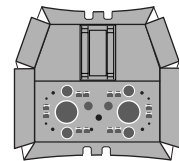

Place 2 magnets on the back to match with magnets from OLM's QD arm



1:100 Scale

SpaceX Heavy Booster 9

Skirt floor and wall

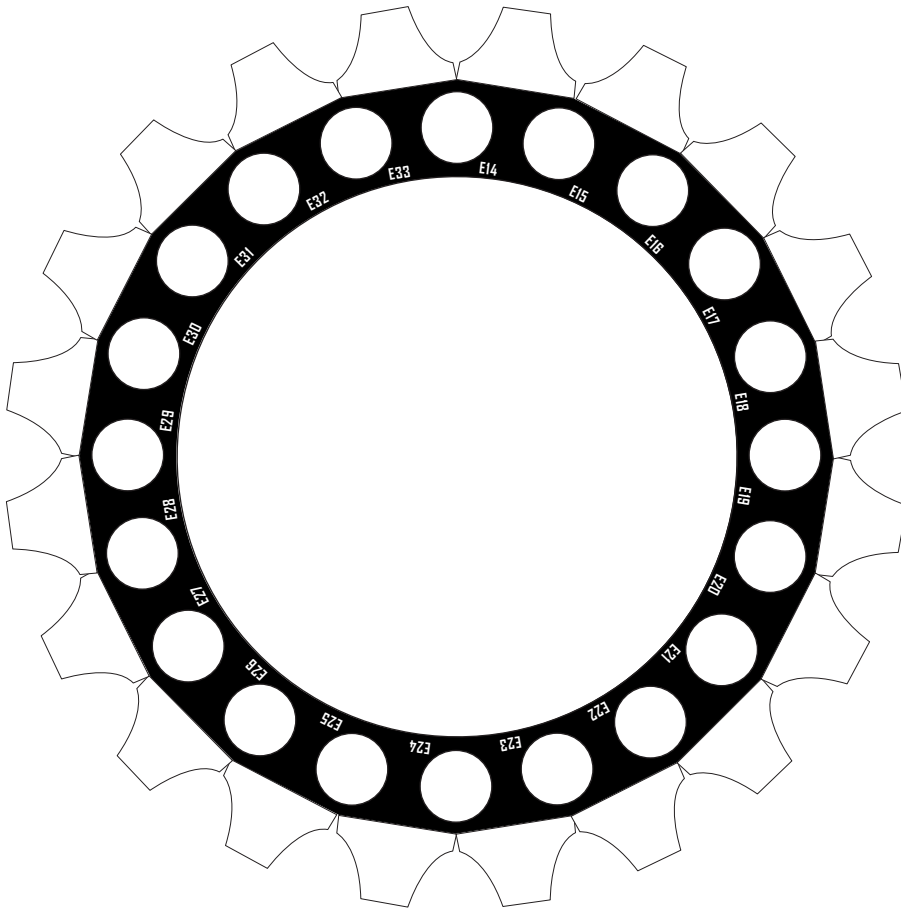

Glue Raptor base

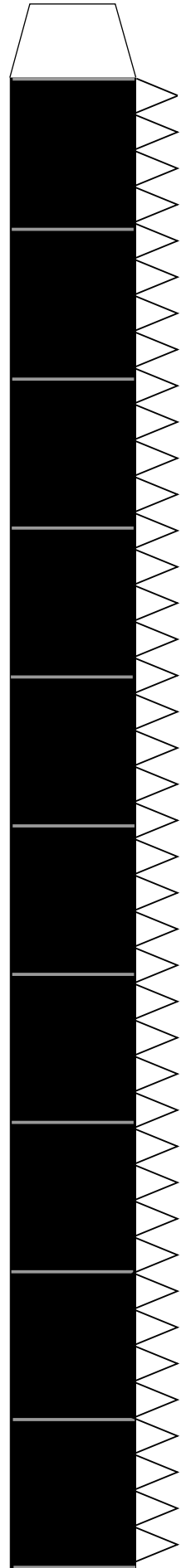
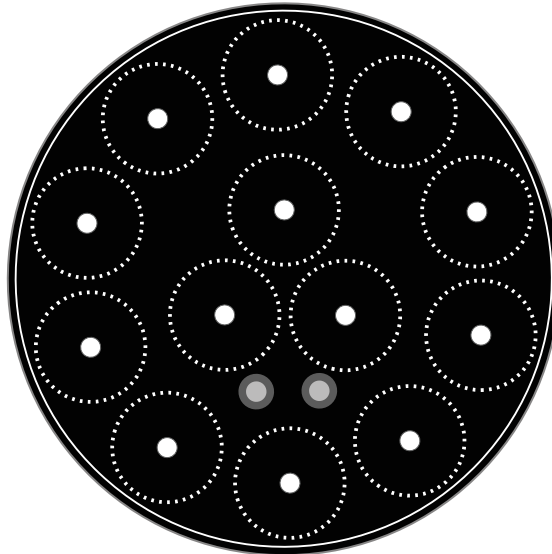

Print on Cardstock (90 lbs)



1 cm

1 inch

1:100 Scale

SpaceX Heavy Booster 10

Raptor location

Umbilical side

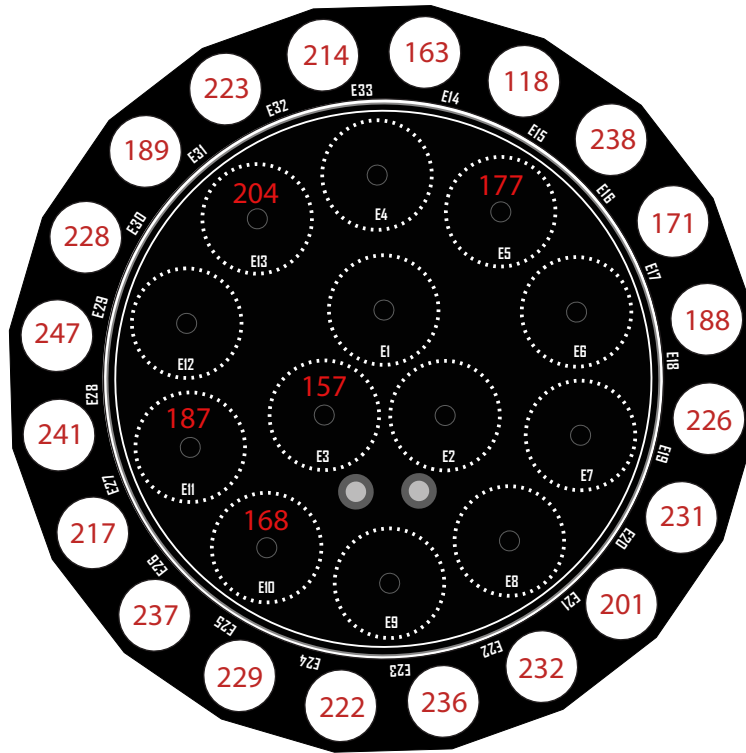

Reference data from Nick (Ring Watchers)



1 cm

B10 inner Raptor covers

Print on cardstock

1 inch

1:100 Scale

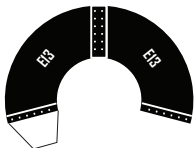
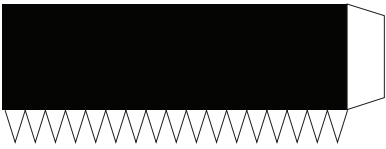
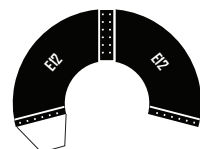
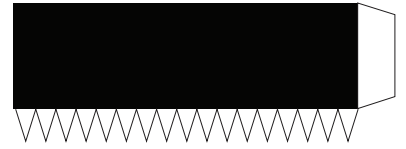
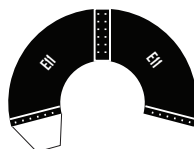
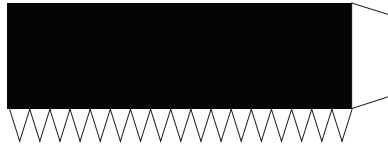
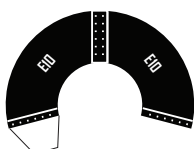
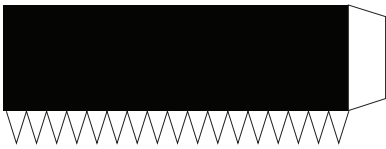
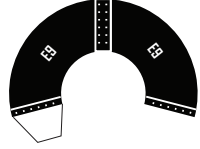
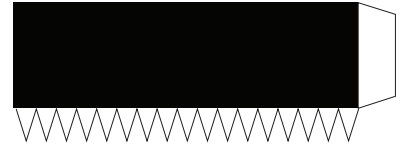
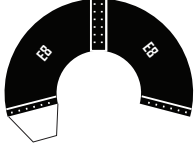
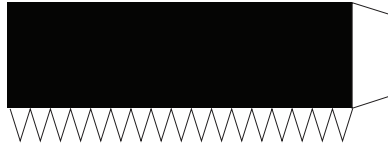
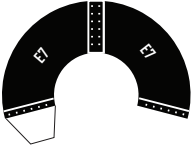
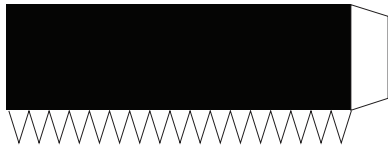
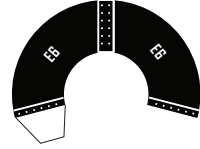
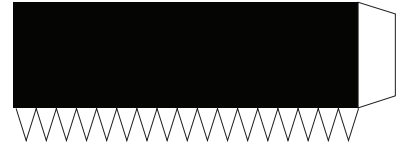
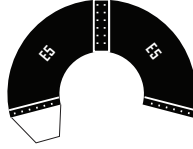
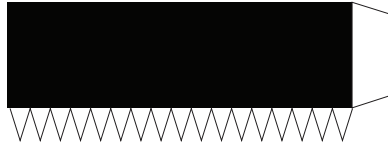
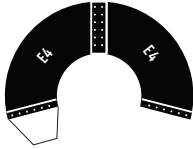
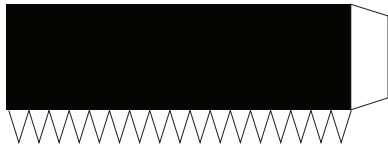
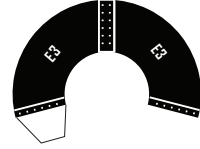
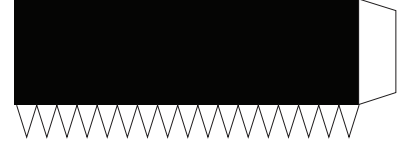
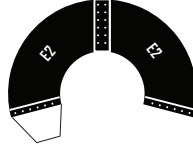
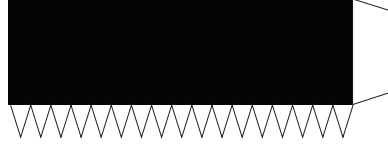
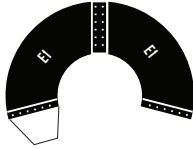
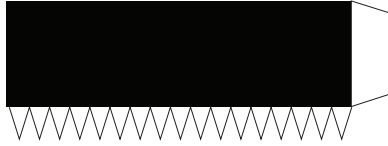



1 cm

1 inch

1:100 Scale

SuperHeavy Raptors

Print on Cardstock (110 lbs)

B10





SuperHeavy Raptors BACKPRINT

Print on Cardstock (110 lbs)

