

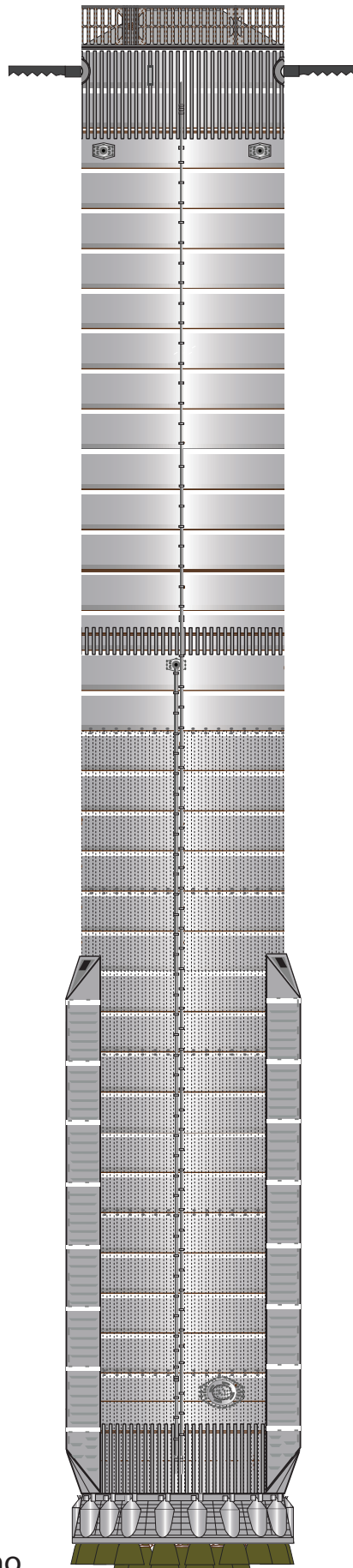

1:100 Scale

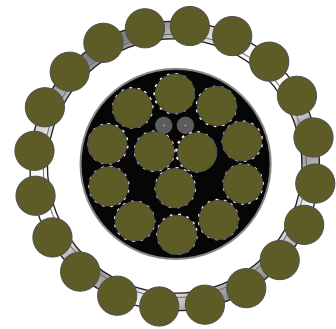

B13

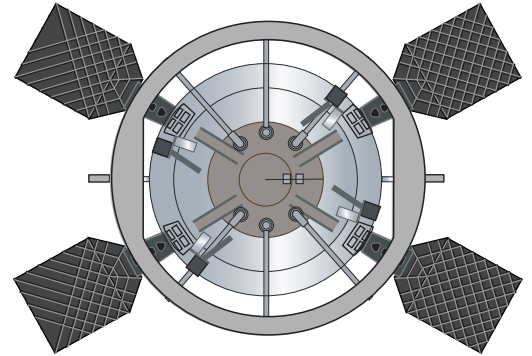
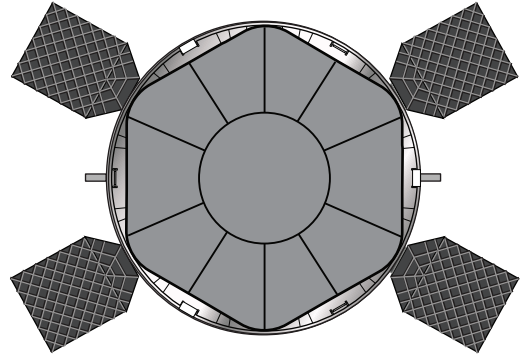

Designed by Alfonso X Moreno
©2024 Not for commercial use



1 cm

1 inch

1:100 Scale

Hot staging Ring

Print on Cardstock (110 lbs)

Top ring

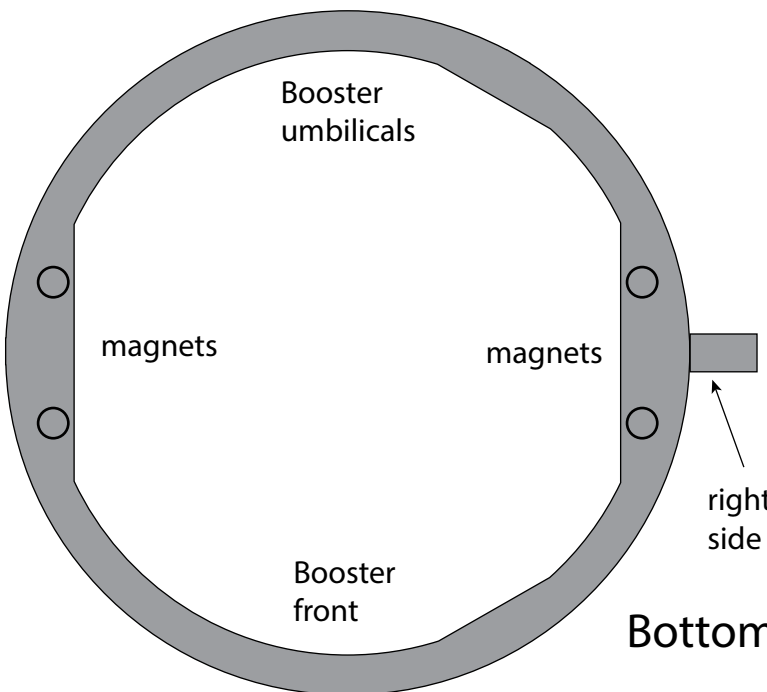
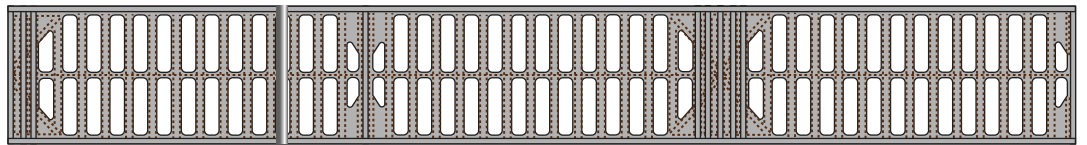
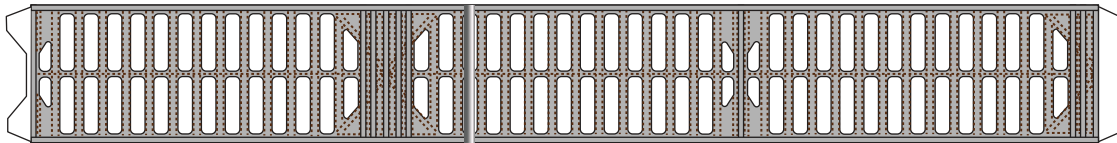
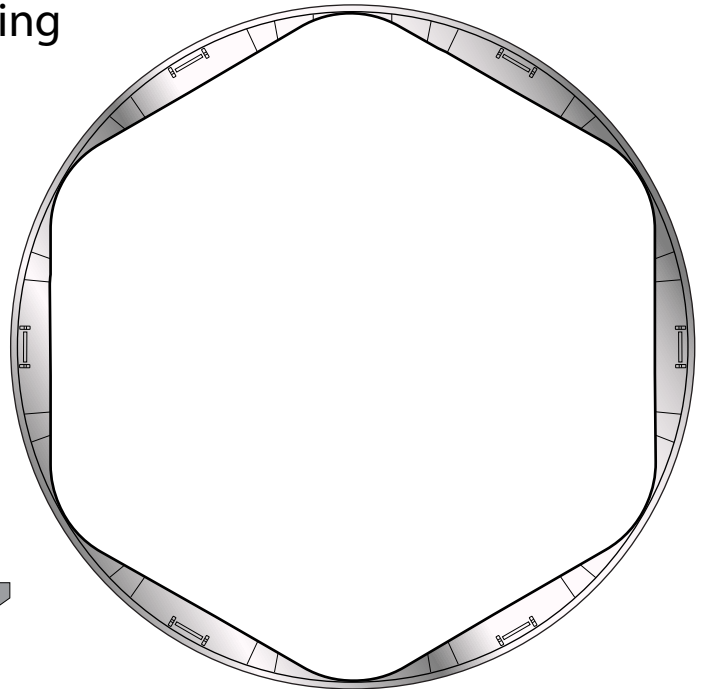
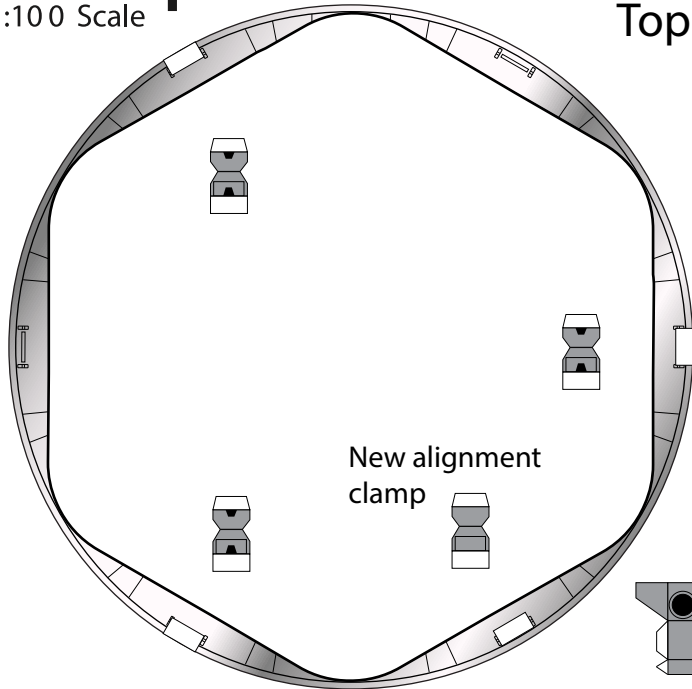

Bottom ring

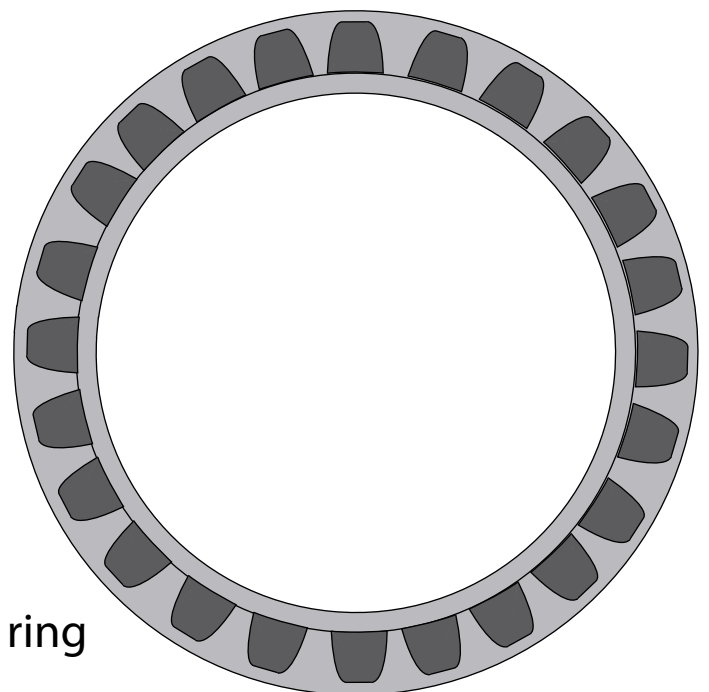



1:100 Scale

Hot staging Ring

Print on Cardstock (110 lbs)

Back Print

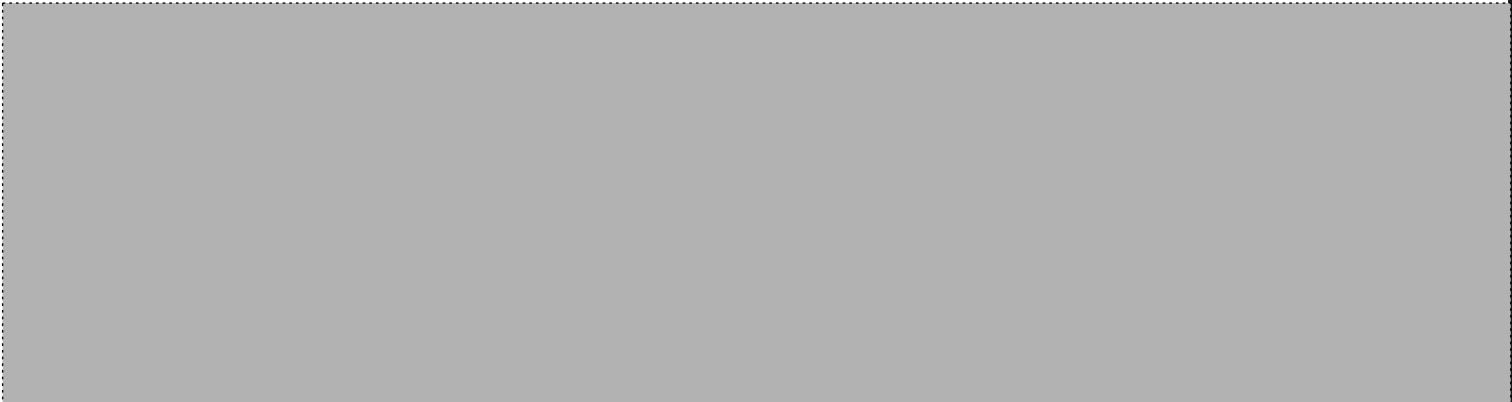



1 cm

1 inch

1:100 Scale

Hot staging Ring

Print on Cardstock (110 lbs)

Simple version

Exterior skin

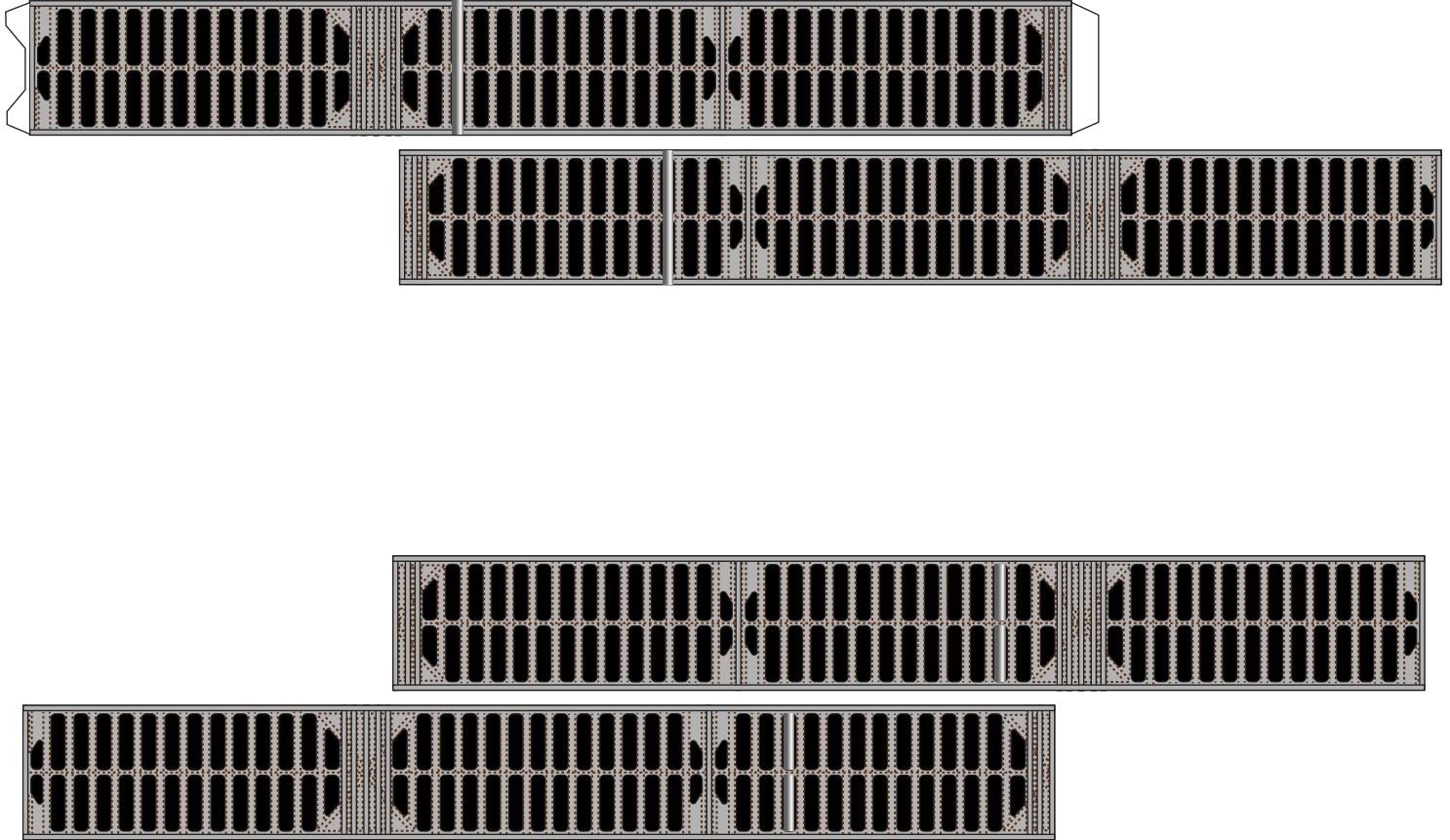

Interior skin



1 cm

1 inch

1:100 Scale

Hot staging Ring Dome

Print on Cardstock (110 lbs)

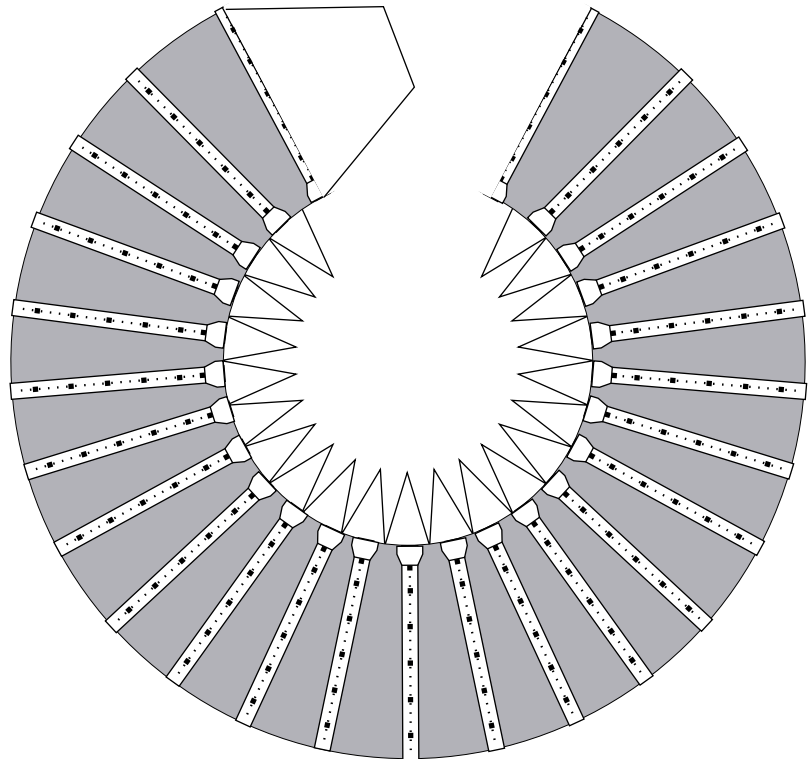
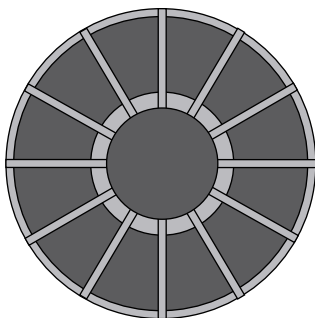
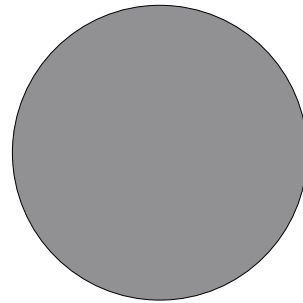
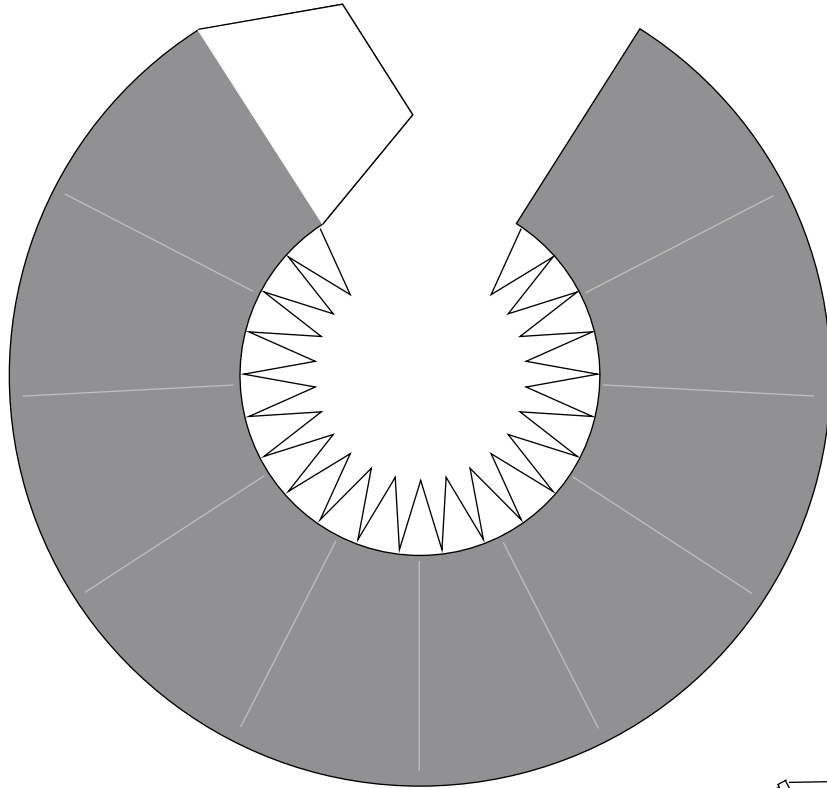



1 cm

1 inch

1:100 Scale

SpaceX SuperHeavy

Print on Cardstock (110 lbs)

Top ring

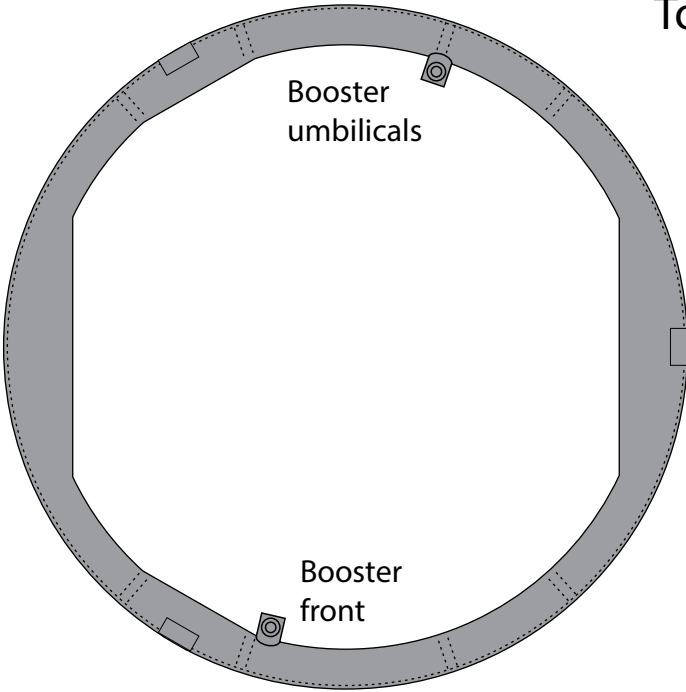

right side

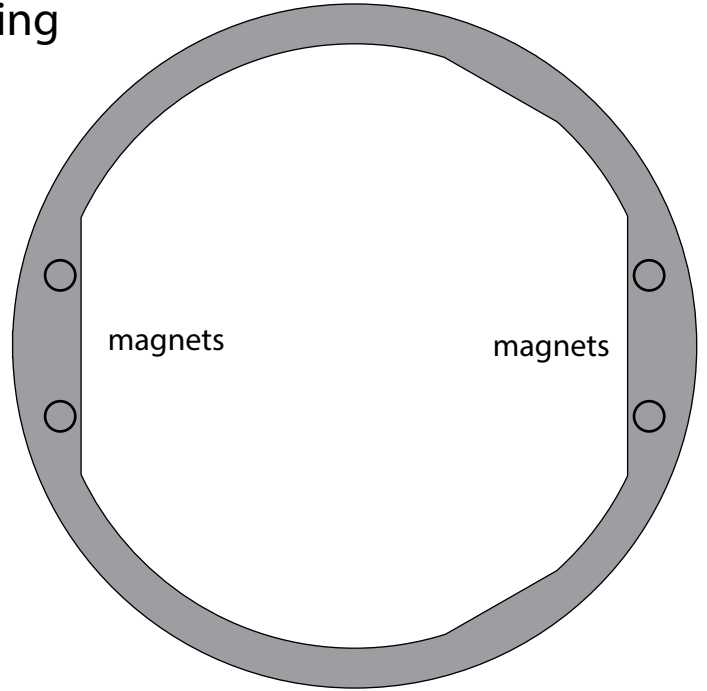

Bottom ring

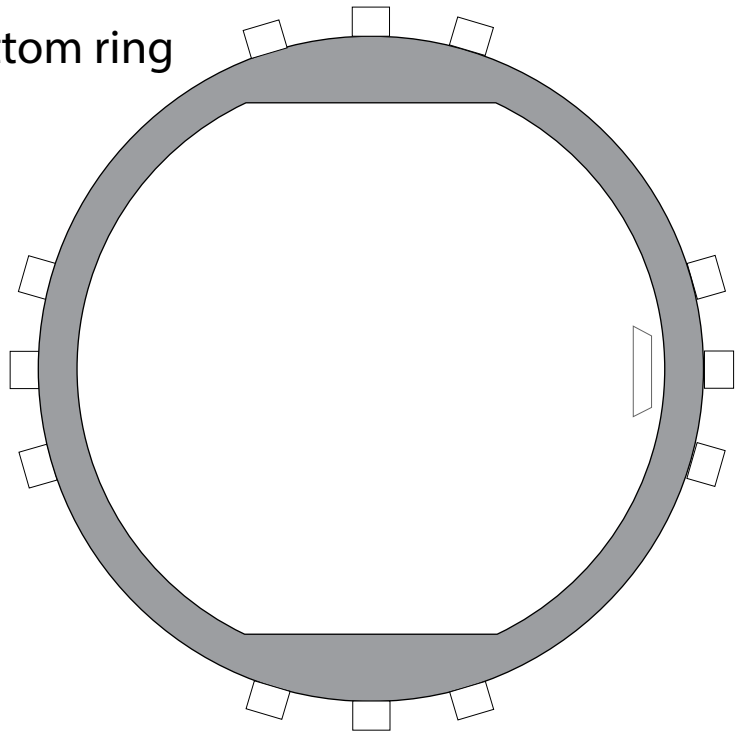
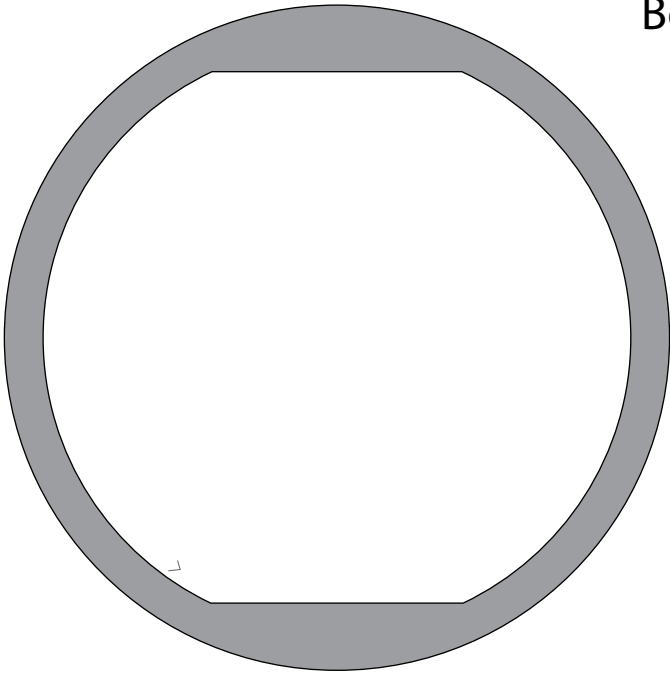



1 cm

1 inch

1:100 Scale

SuperHeavy B13 Upper Dome

Print on Cardstock (110 lbs)

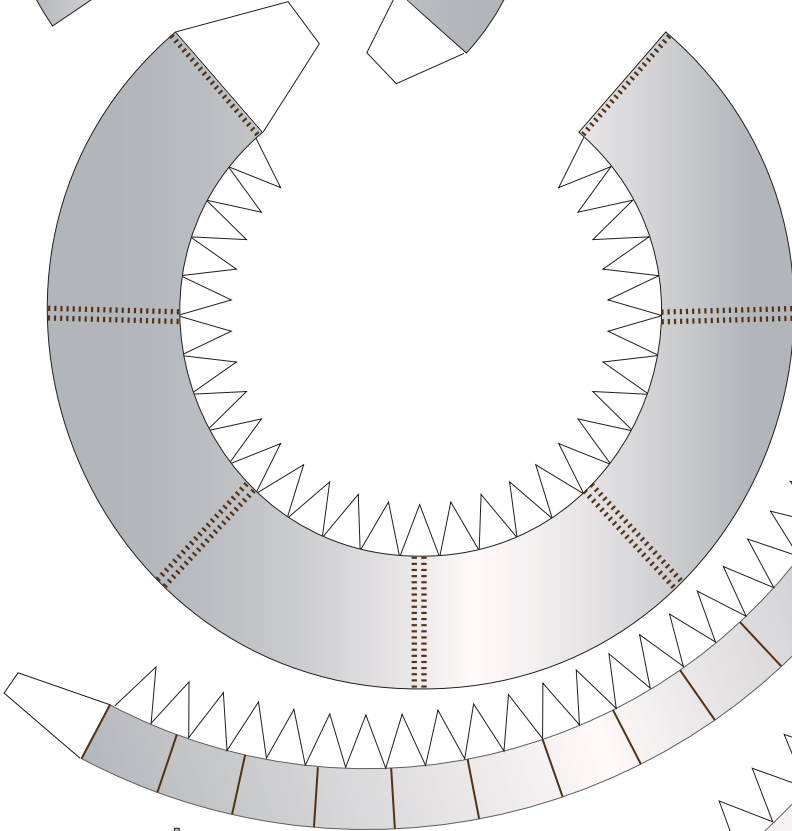
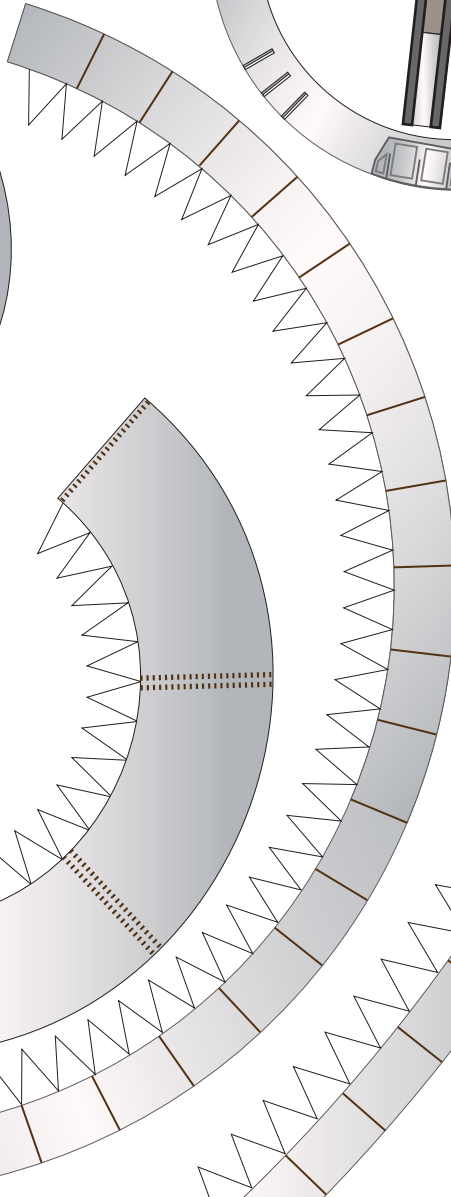
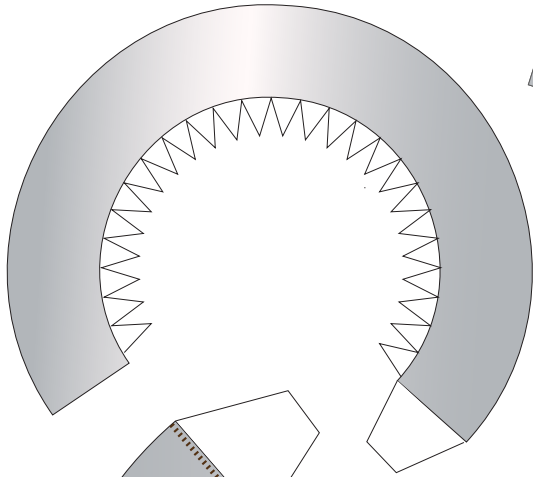
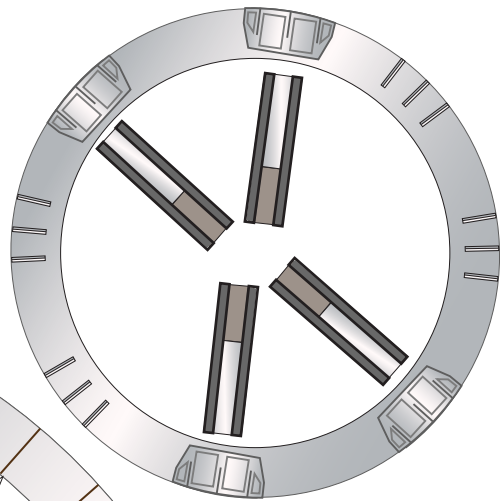
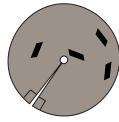
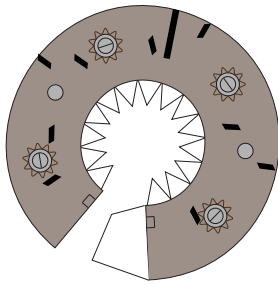

Ch4 vent pipes

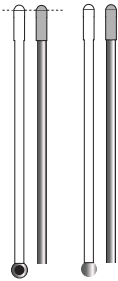

Ch4 vent pipes

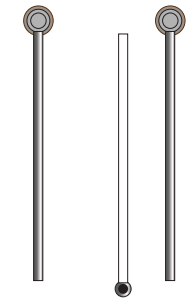
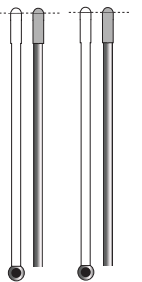

Ch4 press lines

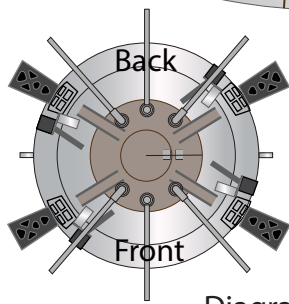

Diagram

Diagram

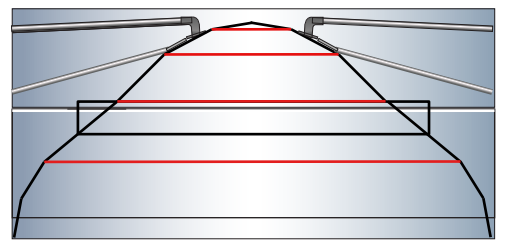



1 cm

1 inch

1:100 Scale

SpaceX Starship B13

Print on Cardstock (110 lbs)

Grid Fins servo motors and Connectors

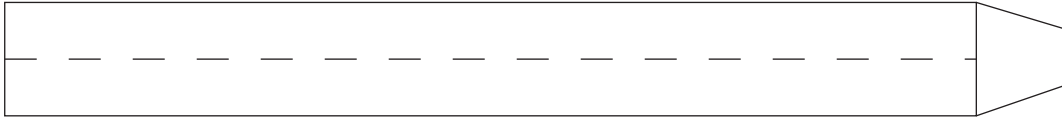
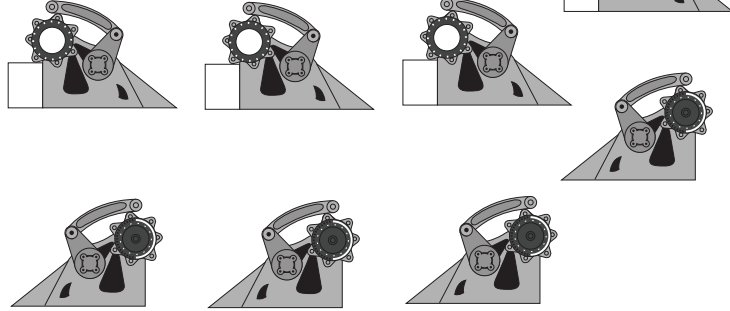
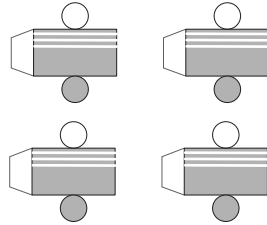
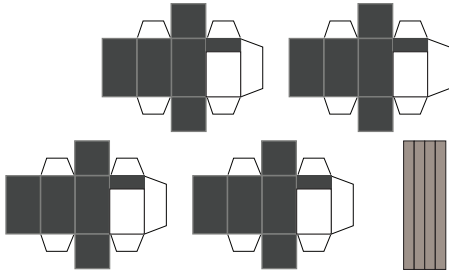

top/middle

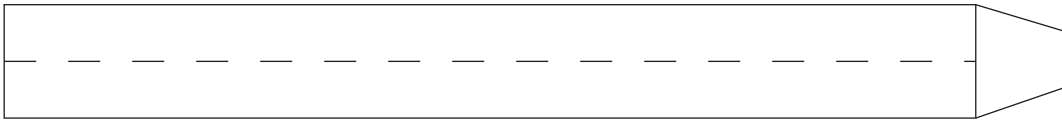
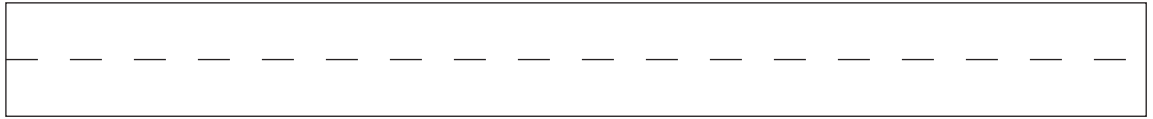

middle/bottom

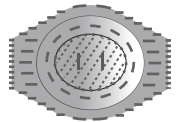

Glue tip of the
Ch4 press line to
cover the black circles

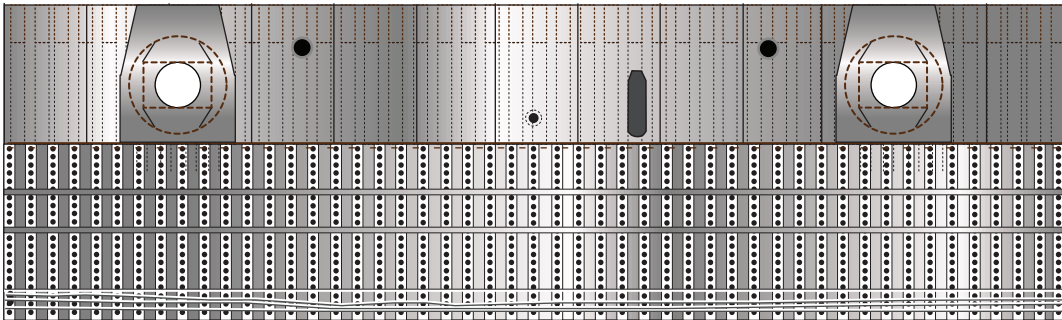
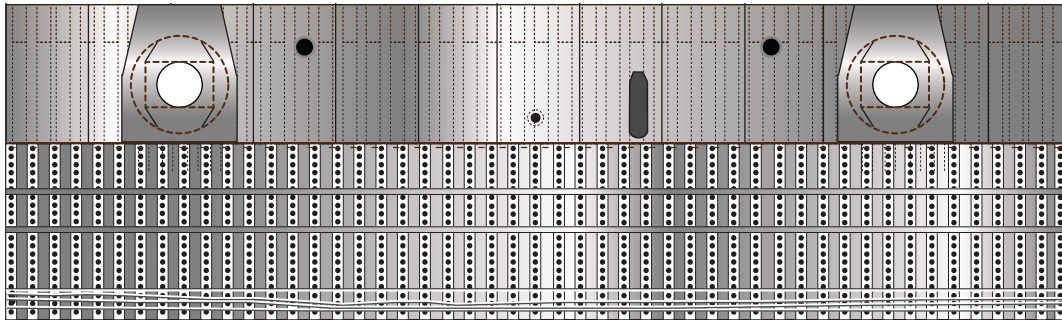

Interior wall
for upper dome
section



1 cm

1 inch

1:100 Scale

SuperHeavy **B13** Grid Fins

Print on Cardstock (110 lbs)

Simple version

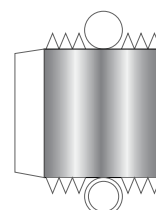
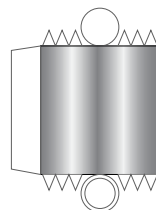
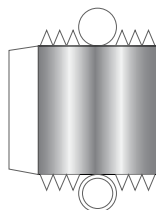
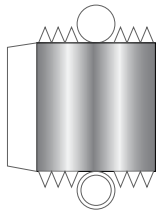
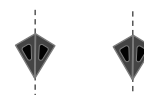
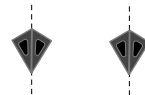
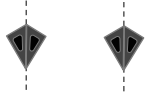
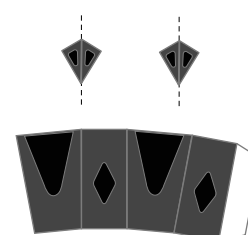
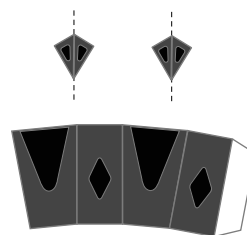
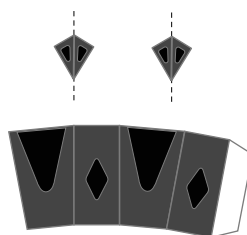
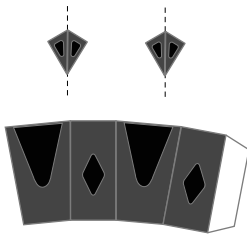
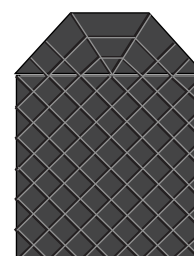
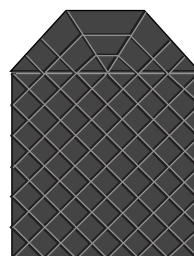
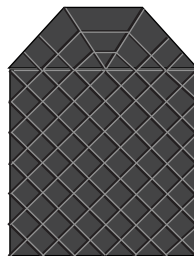
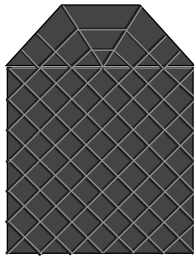
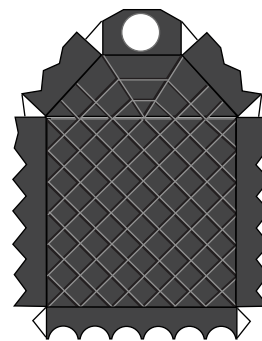
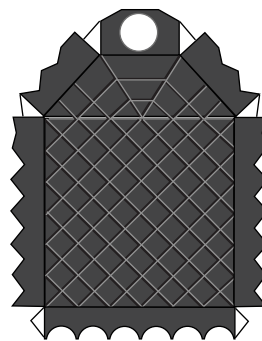
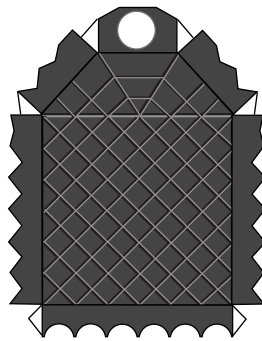
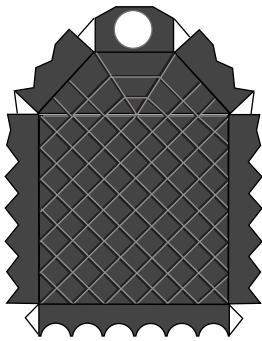



B13 Grid Fins

Print on Cardstock (110 lbs)

Back Print

1:100 Scale





1 cm

1 inch

1:100 Scale

SuperHeavy B13 Grid Fins

Print on Cardstock (110 lbs)

Detailed version

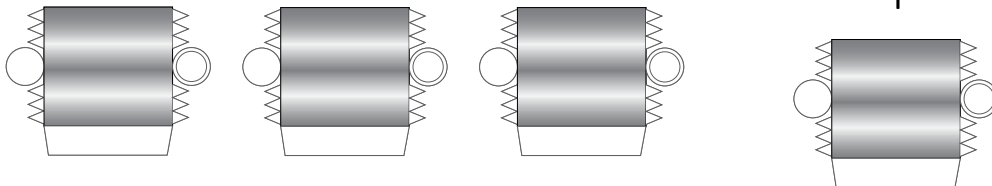
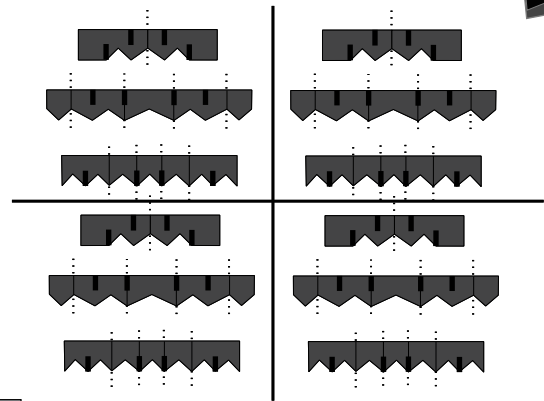
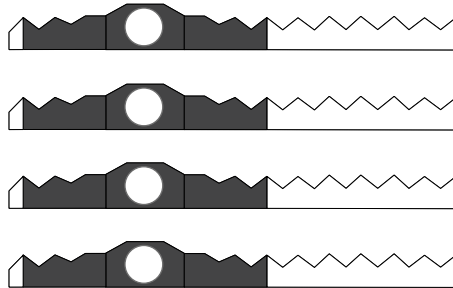
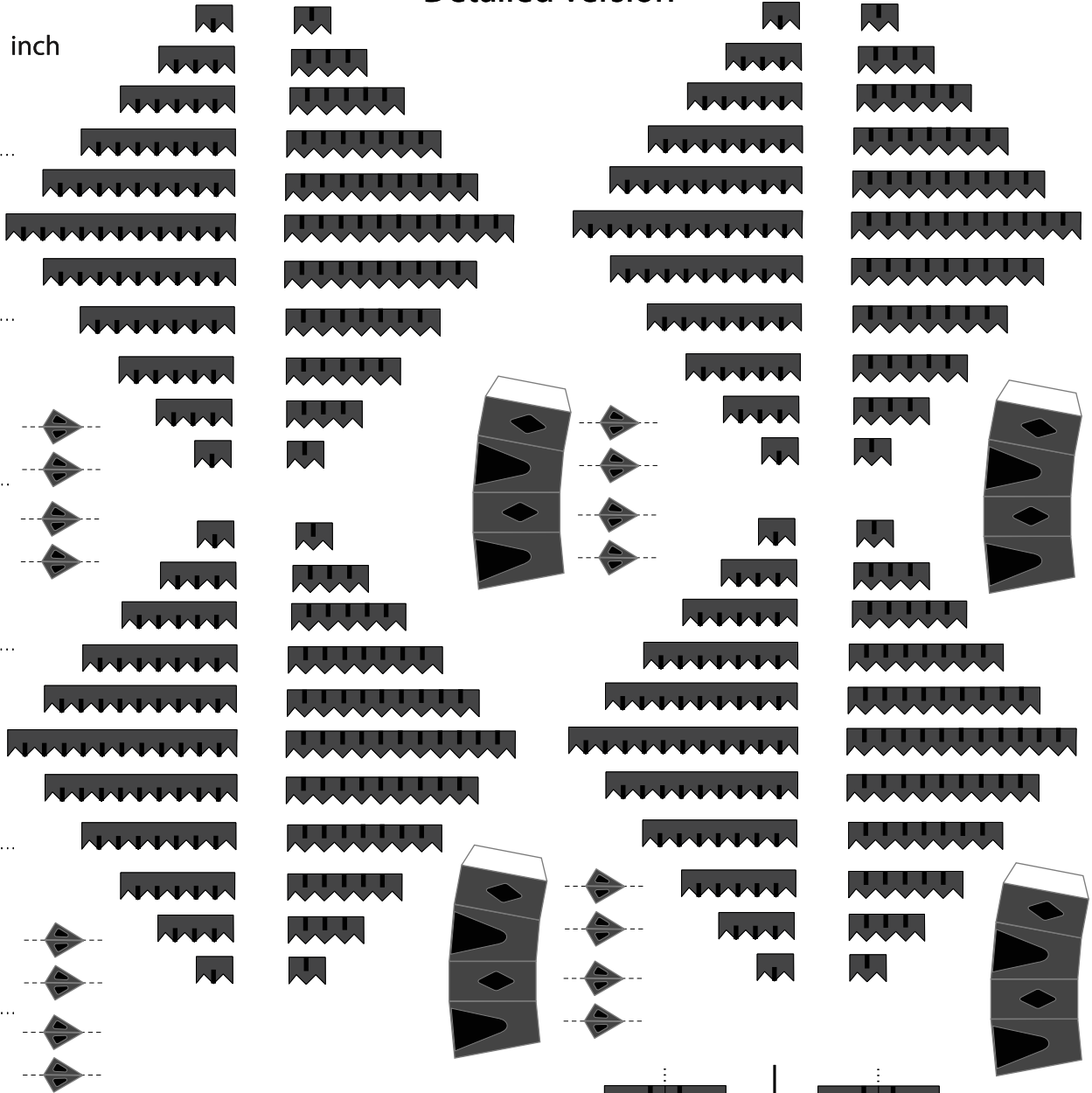
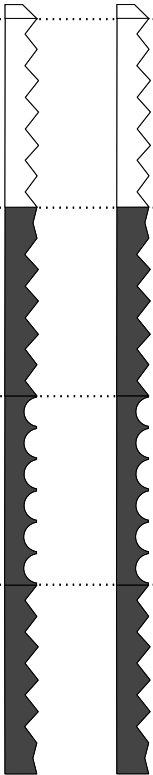



B13 Grid Fins back print

Print on Cardstock (110 lbs)





1 cm

1 inch

1:100 Scale

Booster 13

Print on Cardstock (110 lbs)

Belly side top

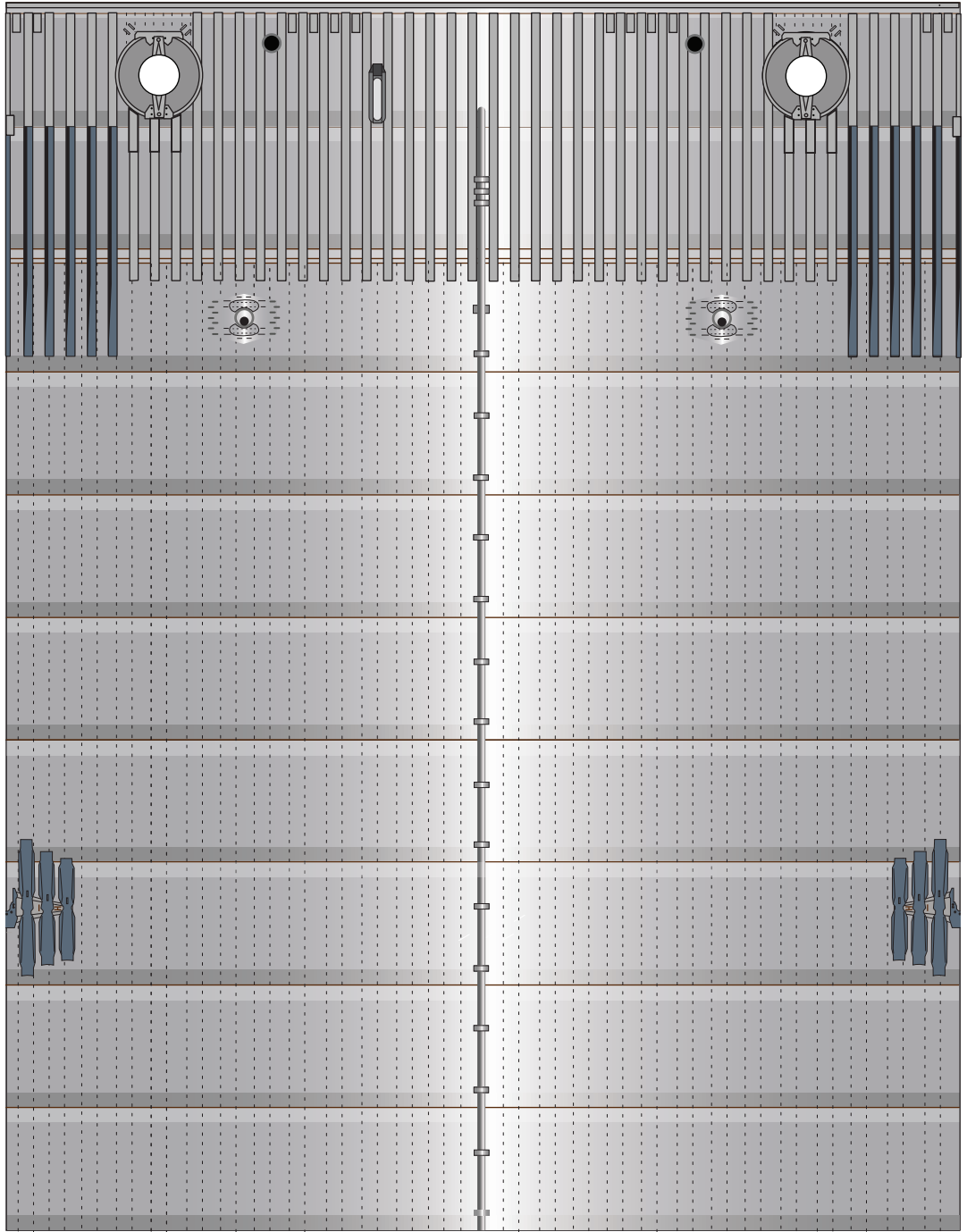
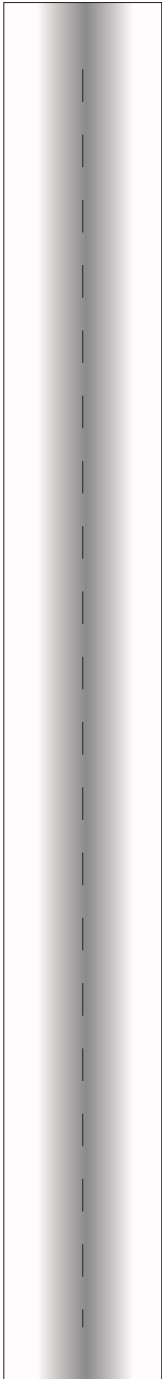
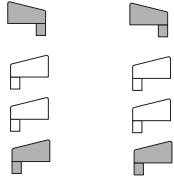



1:100 Scale



Booster 13

Print on Cardstock (110 lbs)

Back side top

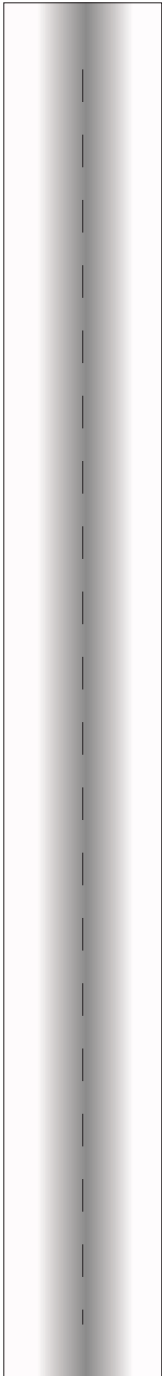



1:100 Scale

Booster 13

Print on Cardstock (110 lbs)
Belly side middle

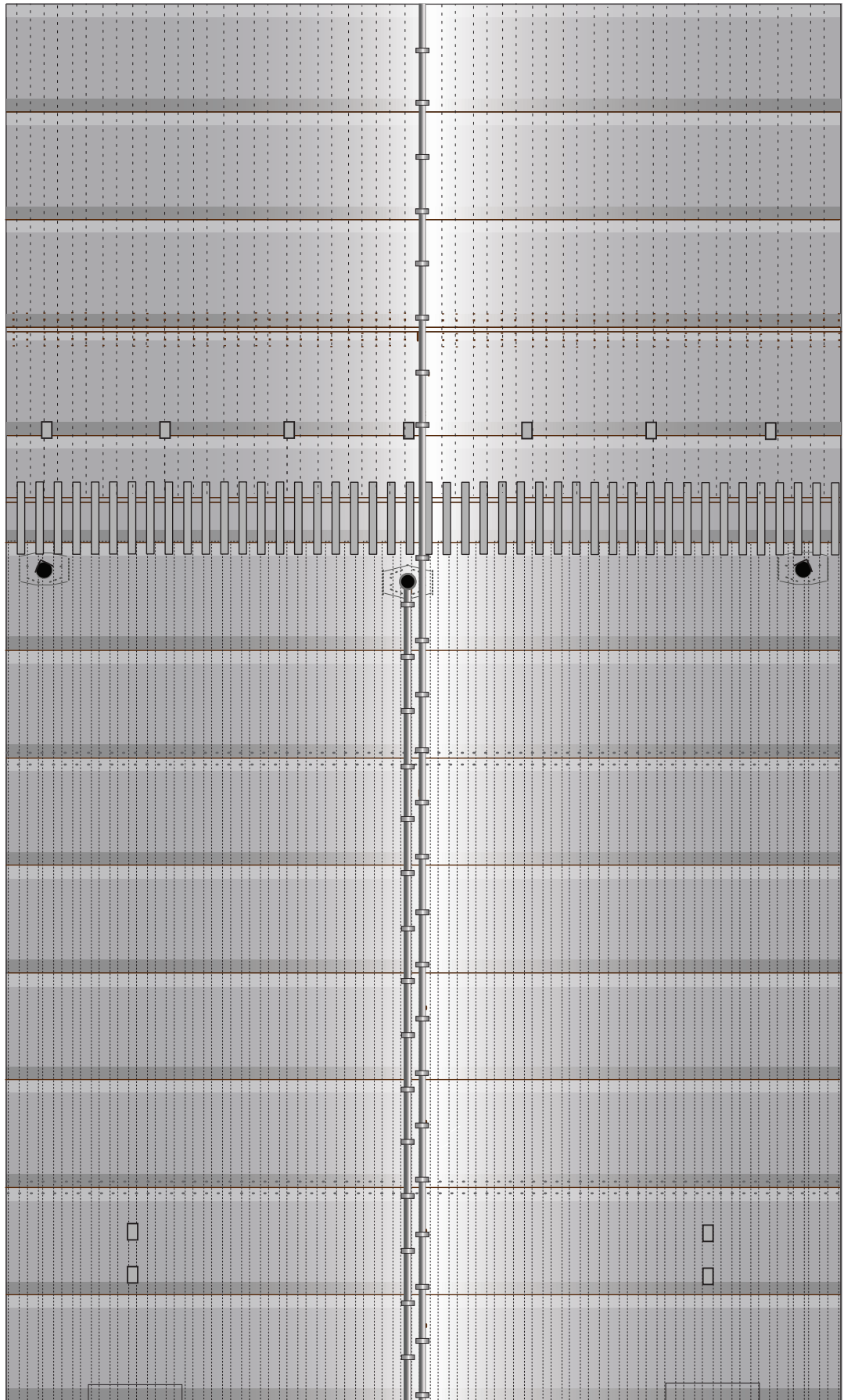
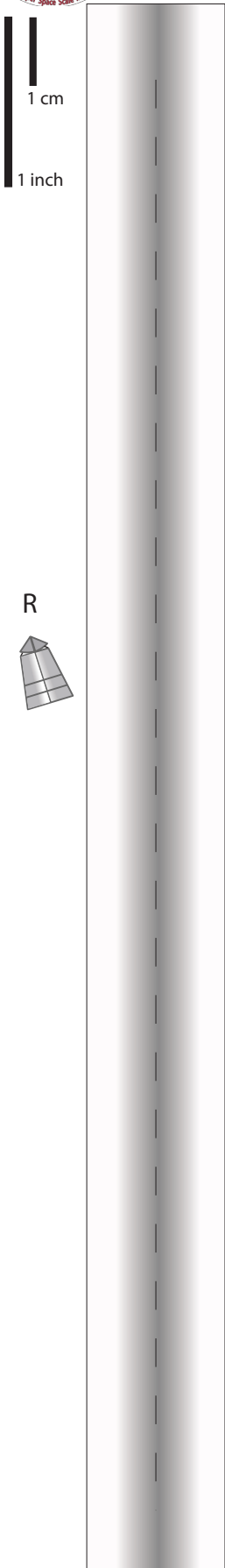



1:100 Scale

Booster 13

Print on Cardstock (110 lbs)
Back side middle



R



L

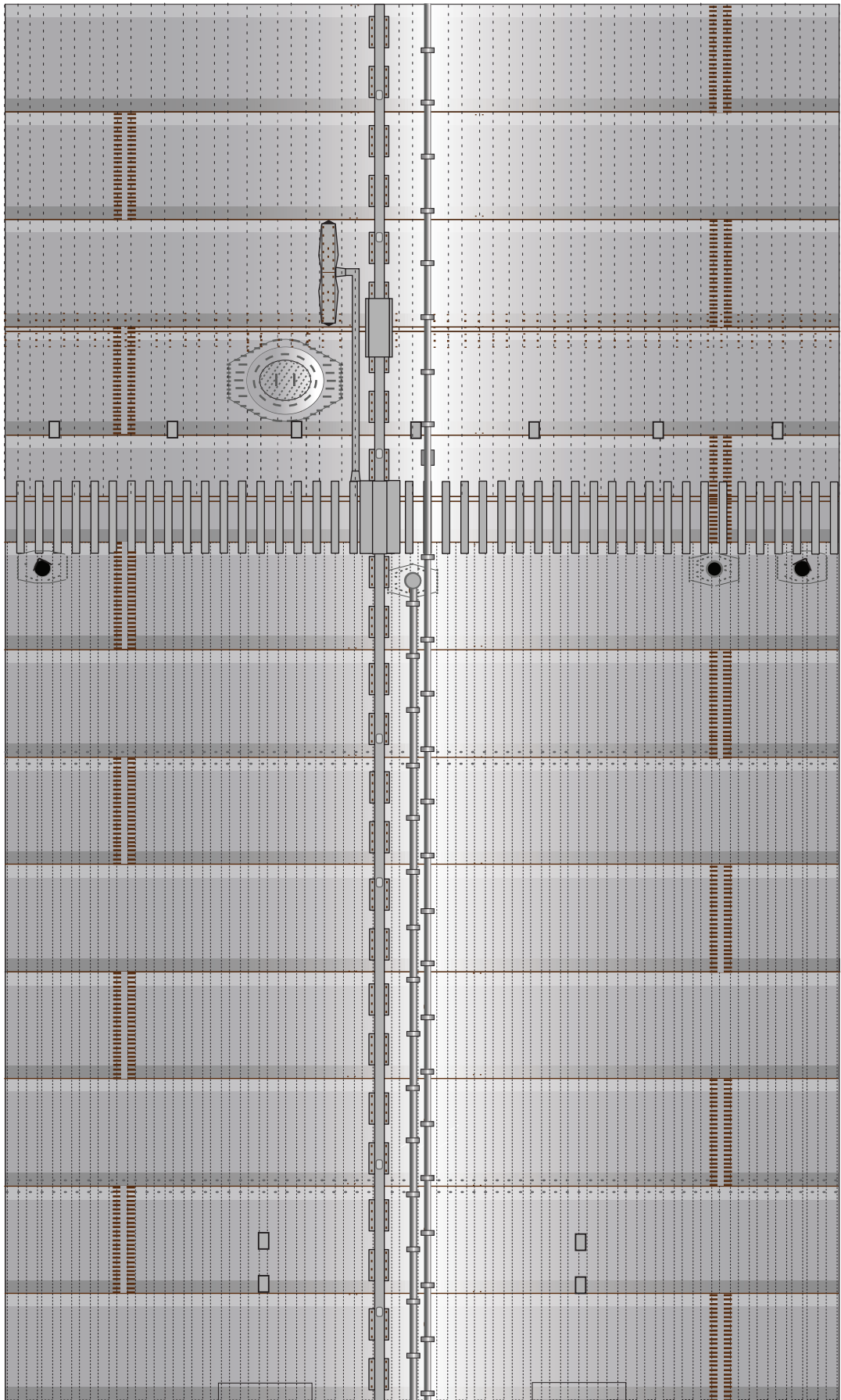



1:100 Scale

Booster 13

Print on Cardstock (110 lbs)

Belly side bottom

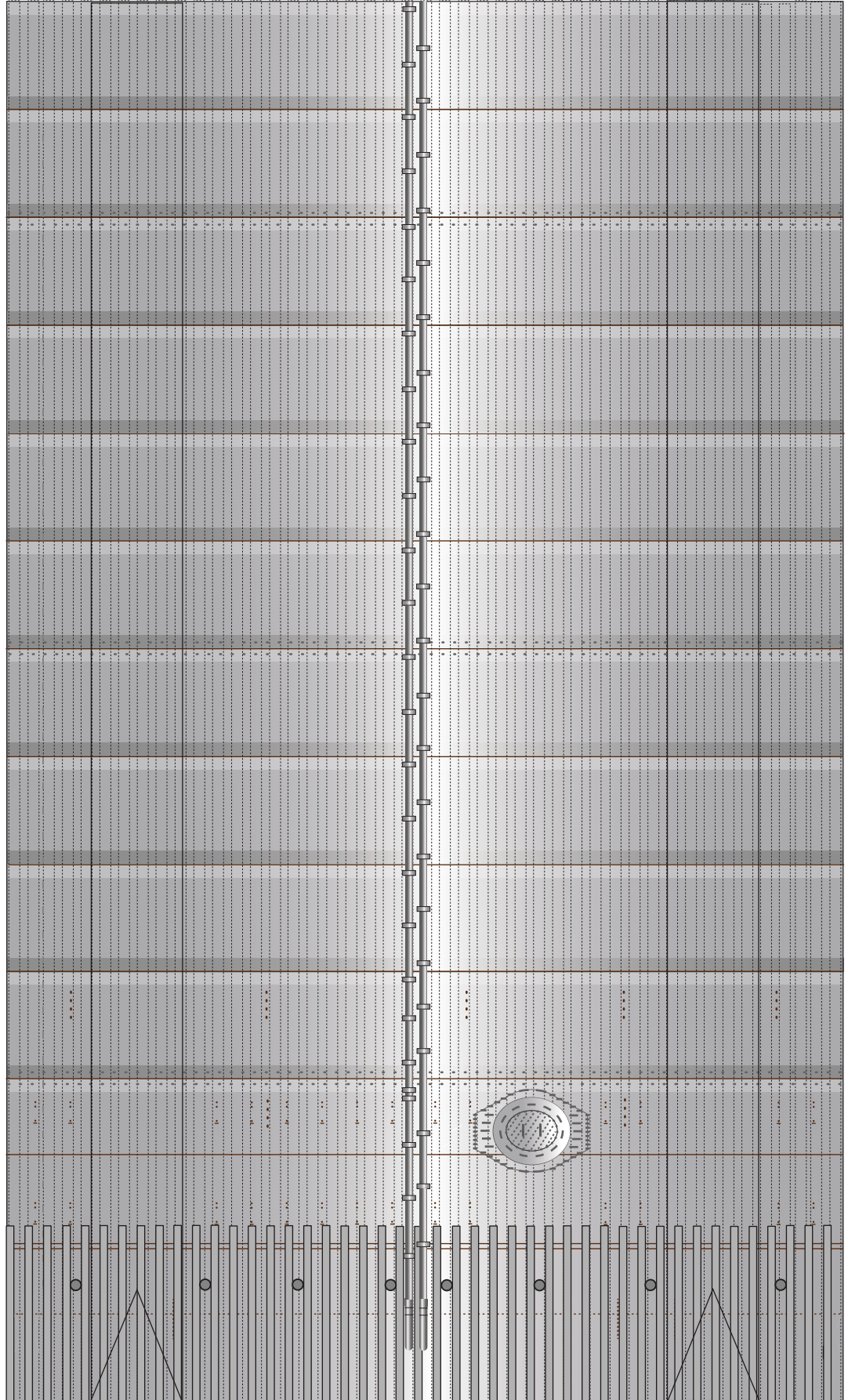
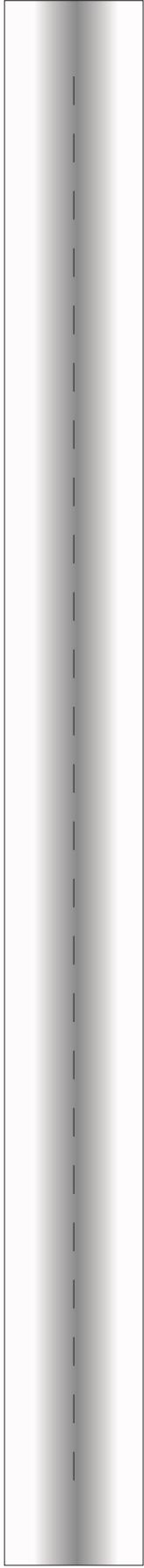



1:100 Scale

Booster 13

Print on Cardstock (110 lbs)
Back side bottom

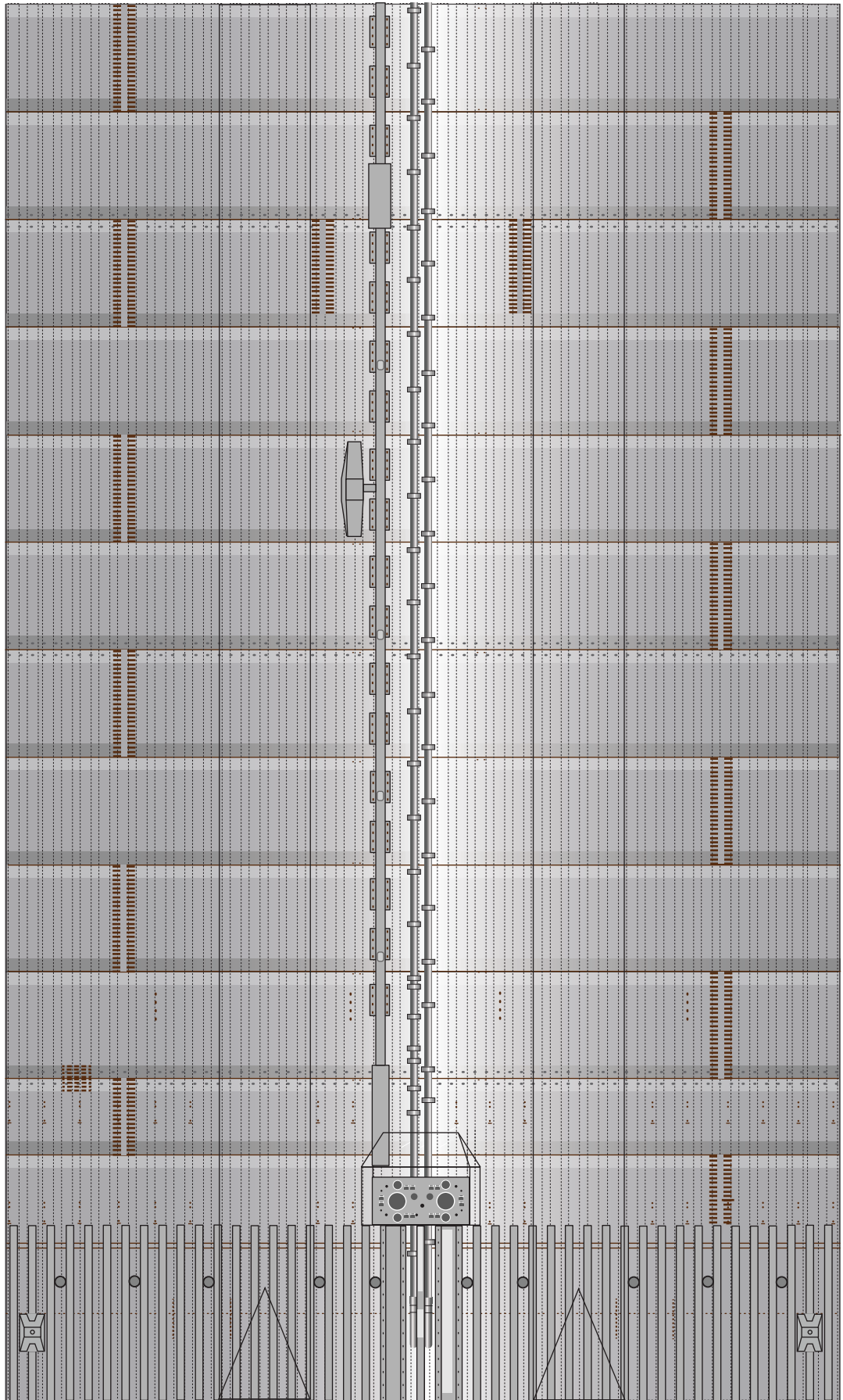
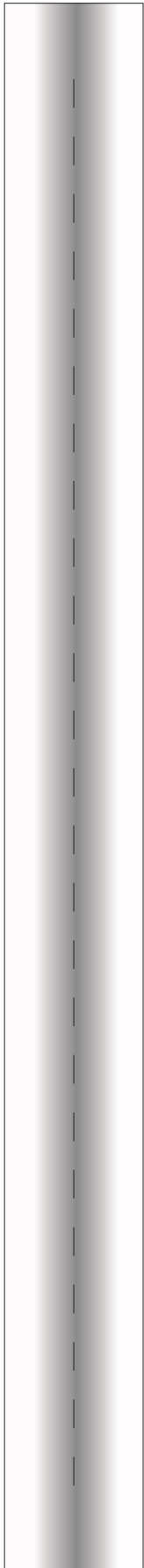



1:100 Scale



COPV covers

FRONT

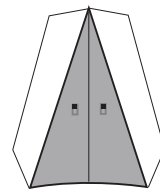
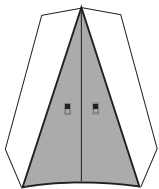
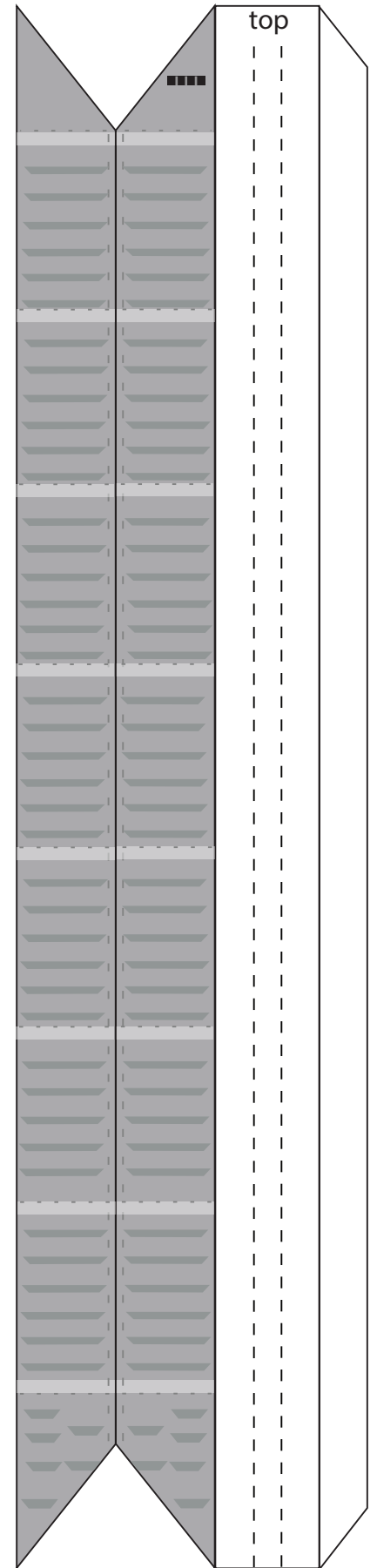
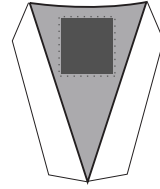
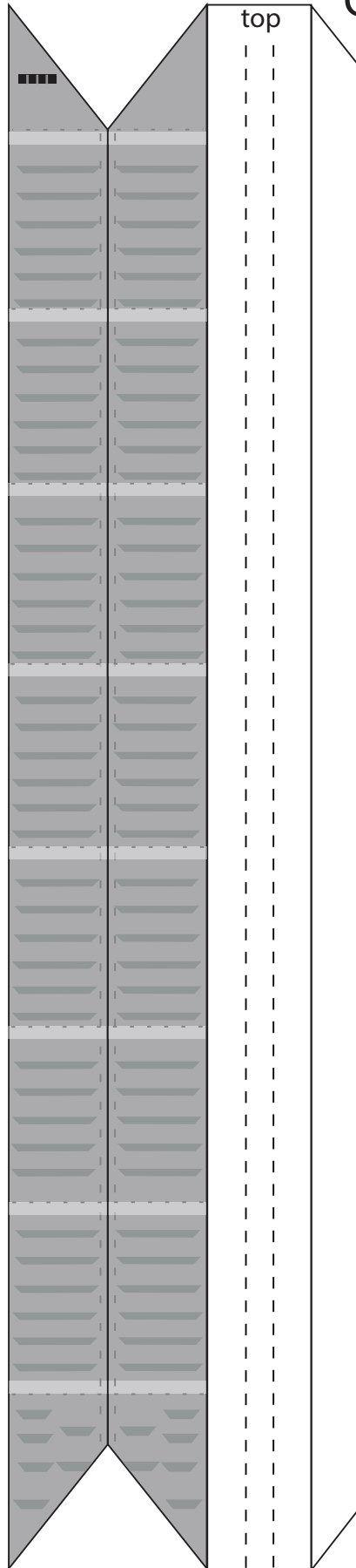
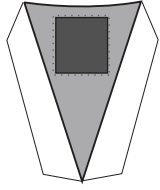



1:100 Scale



COPV covers

Umbilical side

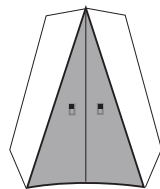
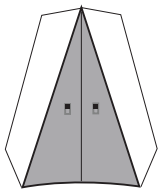
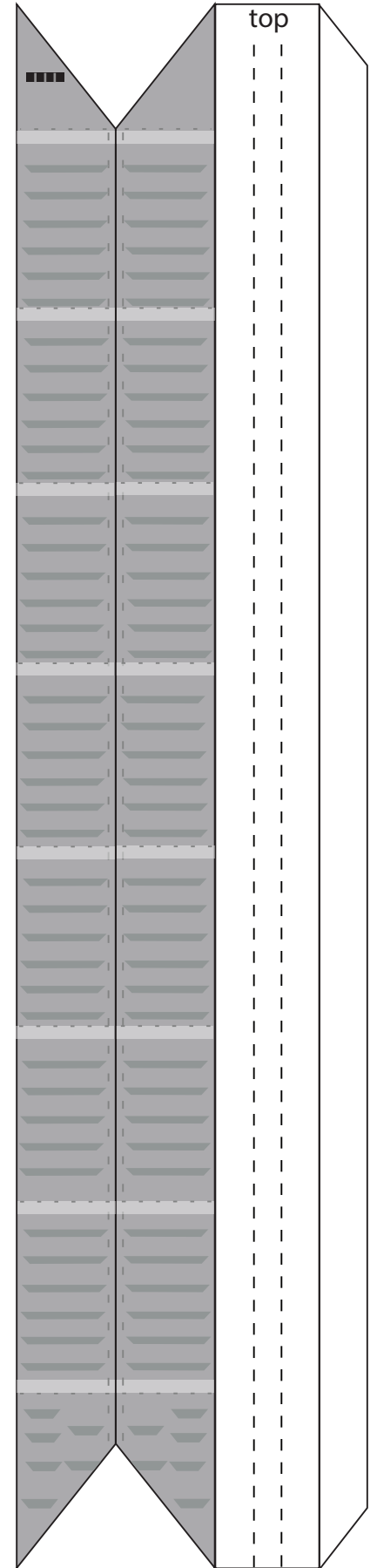
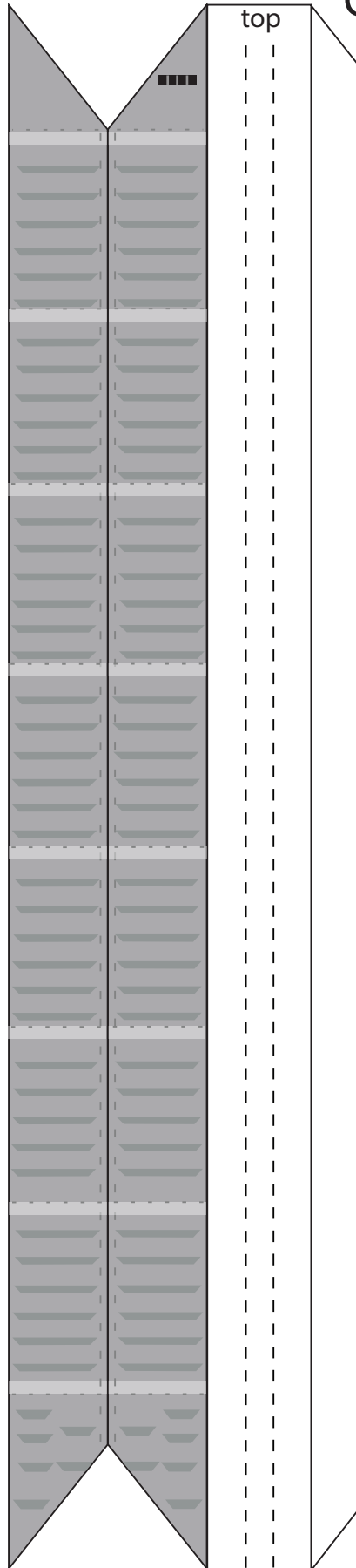
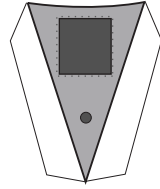
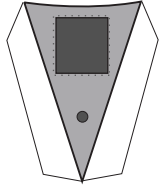



1:100 Scale

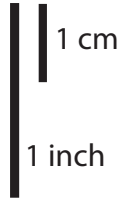

SpaceX Starship **B13**

Print on Cardstock (110 lbs)

Formers for top section

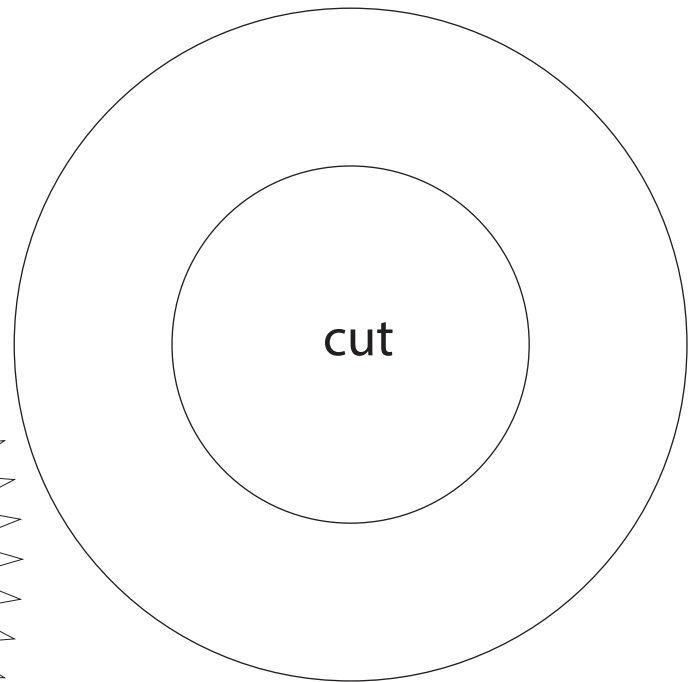
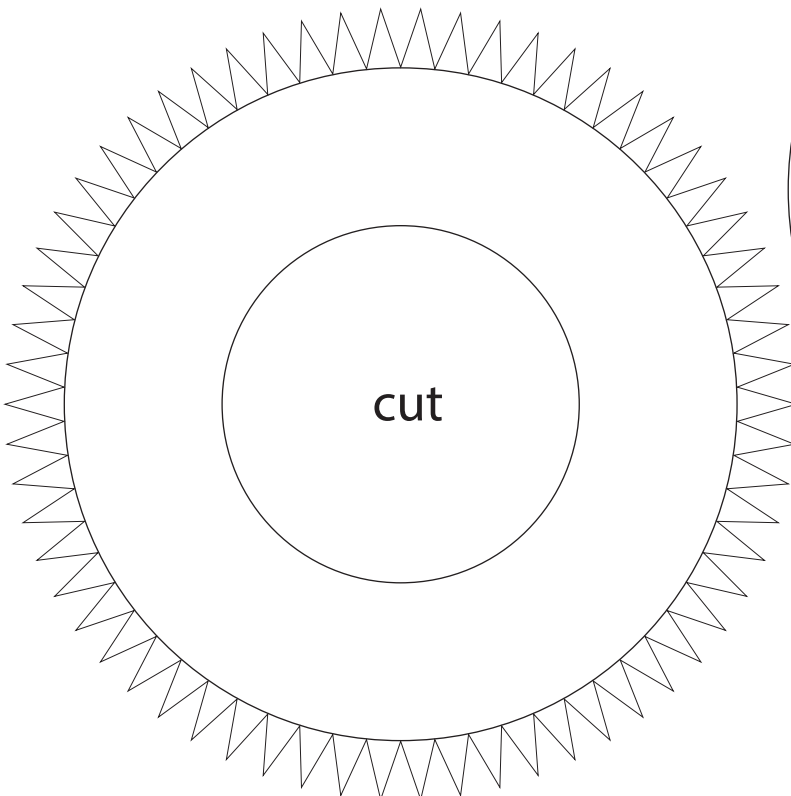
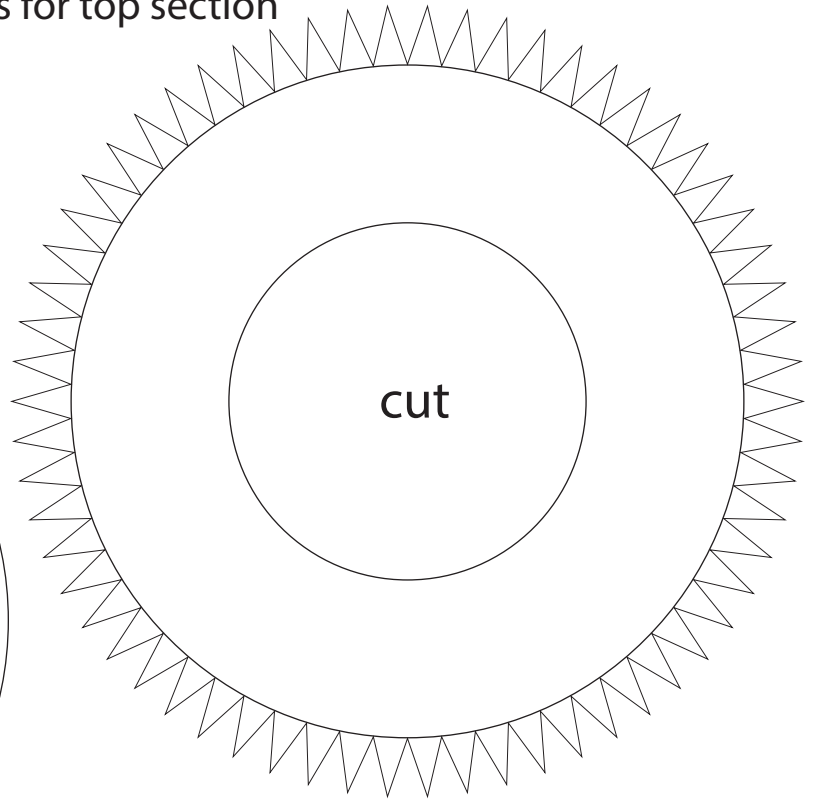
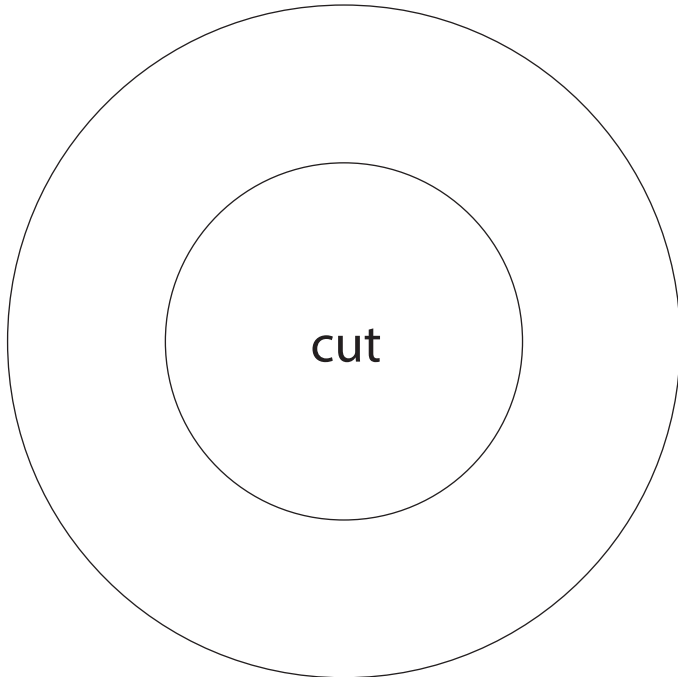

IMPORTANT

Top former is glued 42 mm from top edge of top booster section. Bottom former is glued 20 mm from bottom edge of top booster section.



1:100 Scale

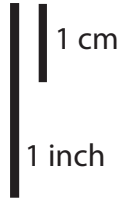

SpaceX Starship **B13**

Print on Cardstock (110 lbs)

Formers for middle body

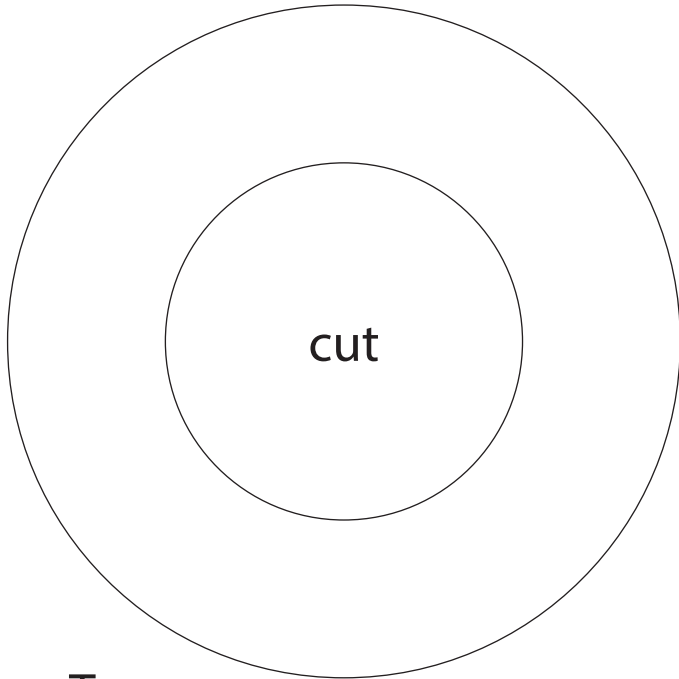

Top

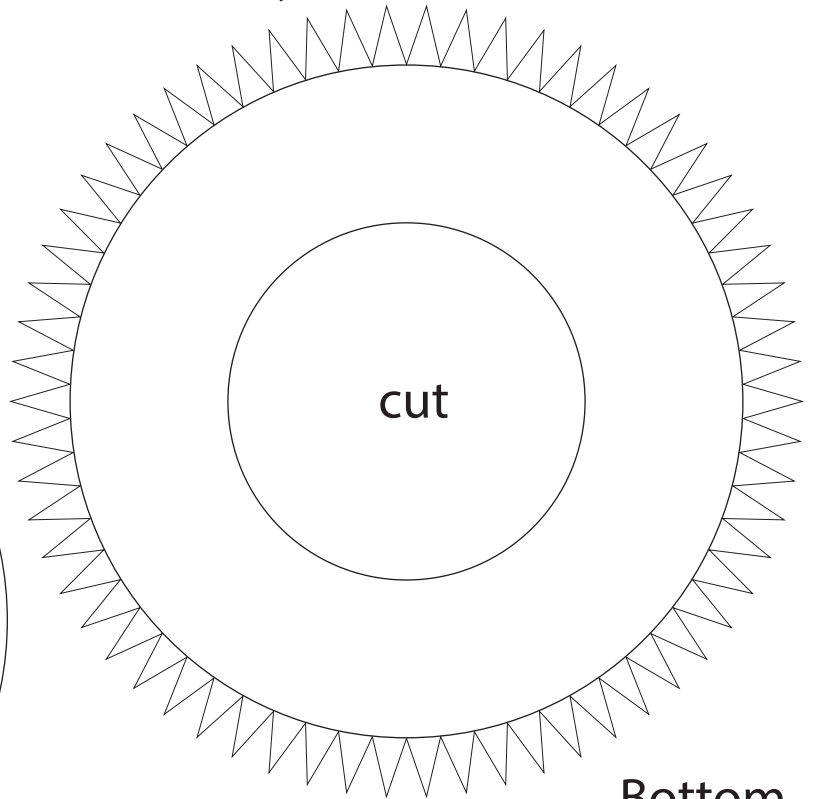

Bottom

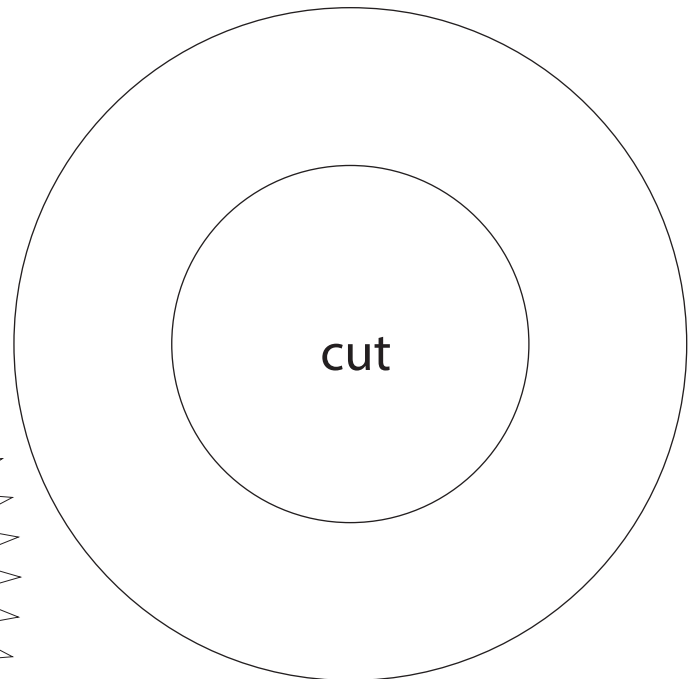
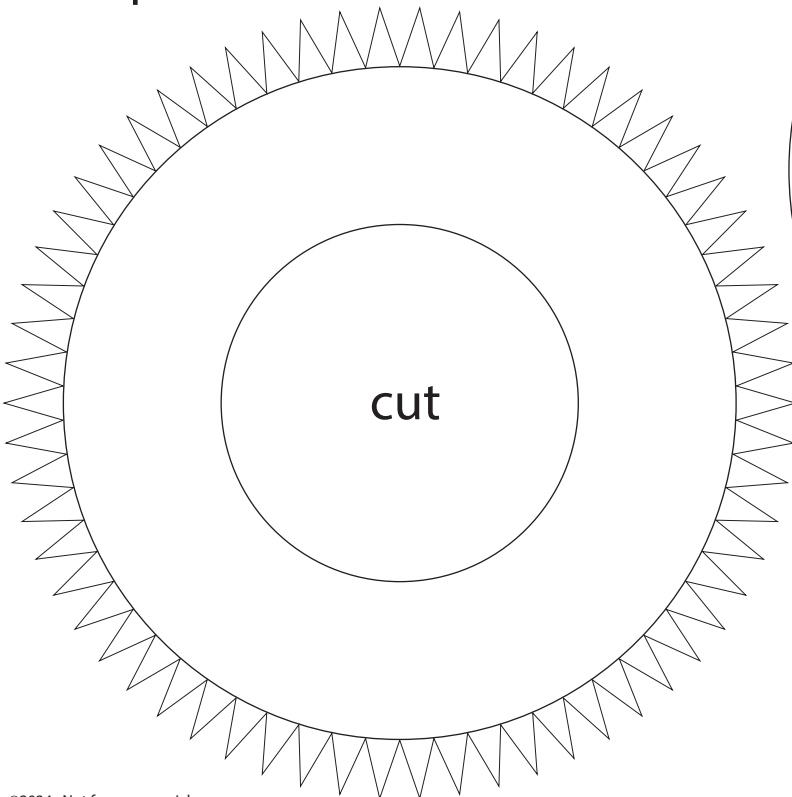

IMPORTANT

Top former is glued 20 mm from top edge of middle booster section. Bottom former is glued 20 mm from bottom edge of middle booster section.



1:100 Scale

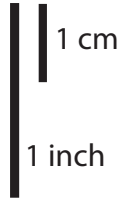

SpaceX Starship **B13**

Print on Cardstock (110 lbs)

Formers for bottom body

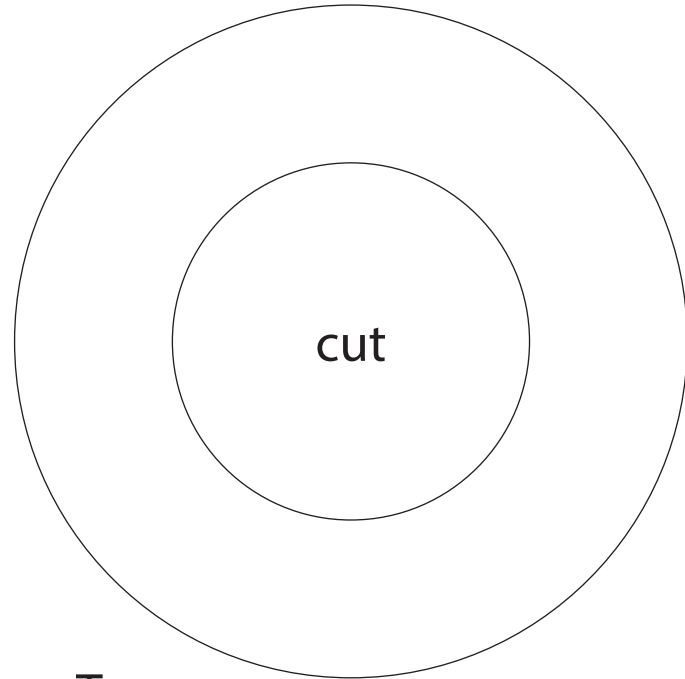

Top

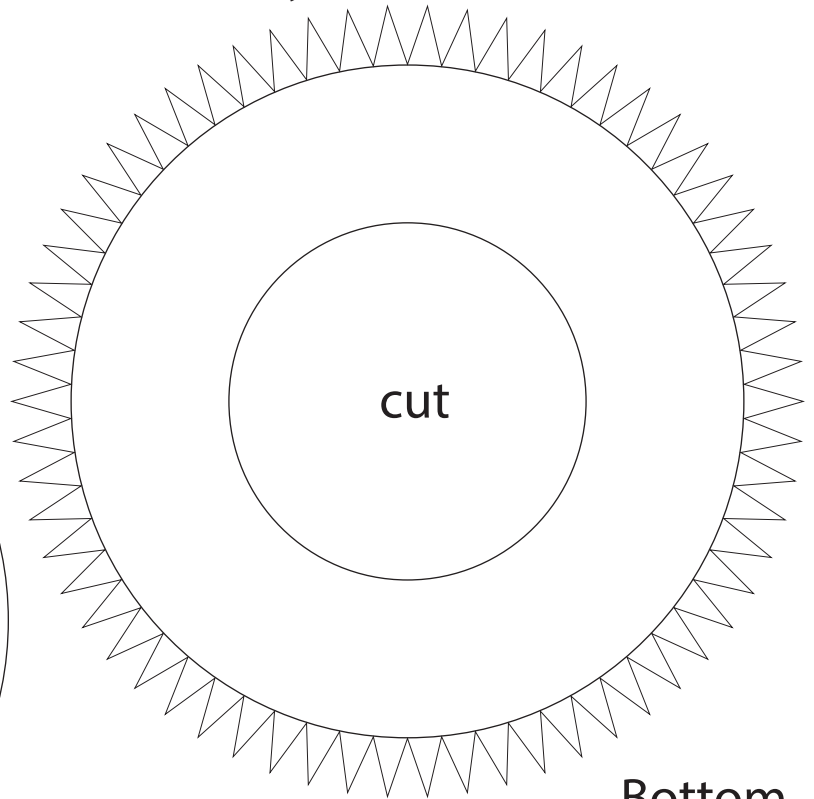

Bottom

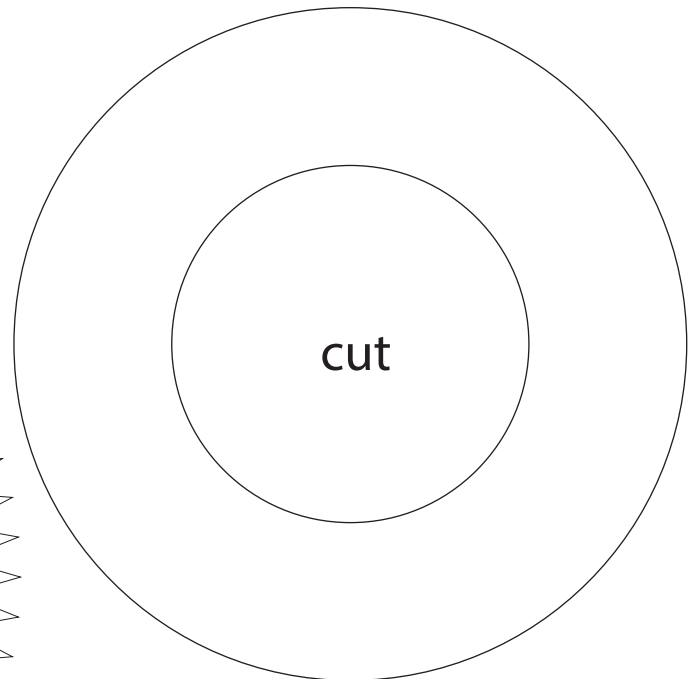
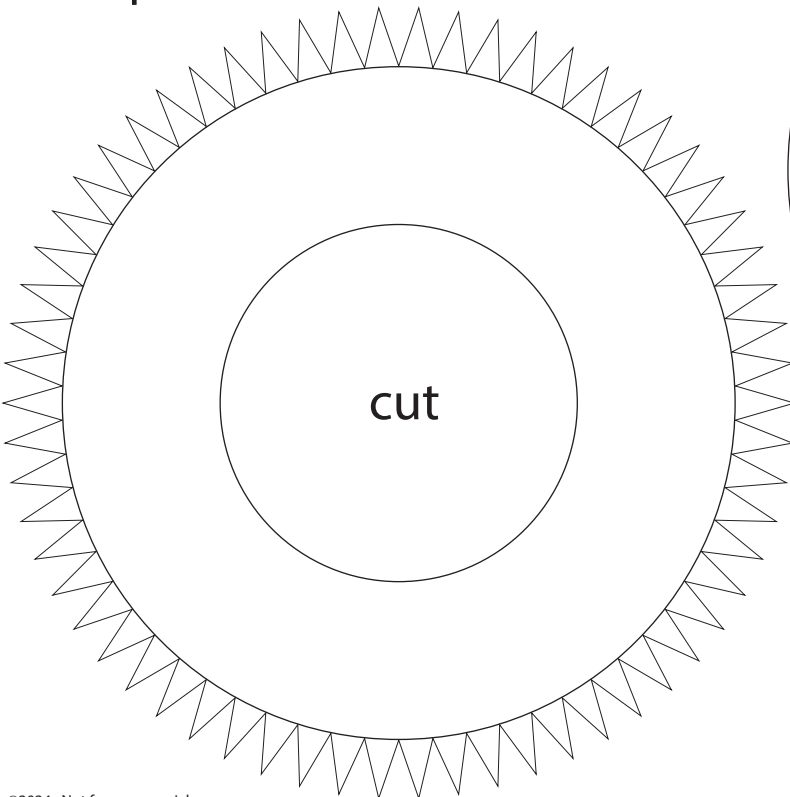

IMPORTANT

Top former is glued 20 mm from top edge of bottom booster section. Bottom former is glued 19 mm from bottom edge of bottom booster section.



1 cm

1 inch

1:100 Scale

SpaceX SuperHeavy

Print on Cardstock (110 lbs)

Outer Raptor ring

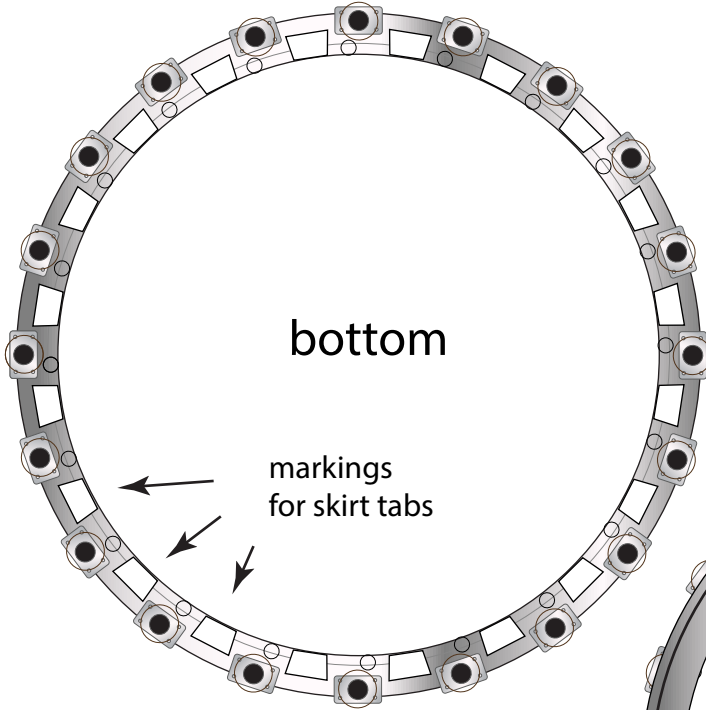

bottom

markings
for skirt tabs



top



Engine section interior layer





1 cm

1 inch

1:100 Scale

SpaceX Heavy Booster 13

Print on Cardstock (90 lbs)

Skirt for engine section

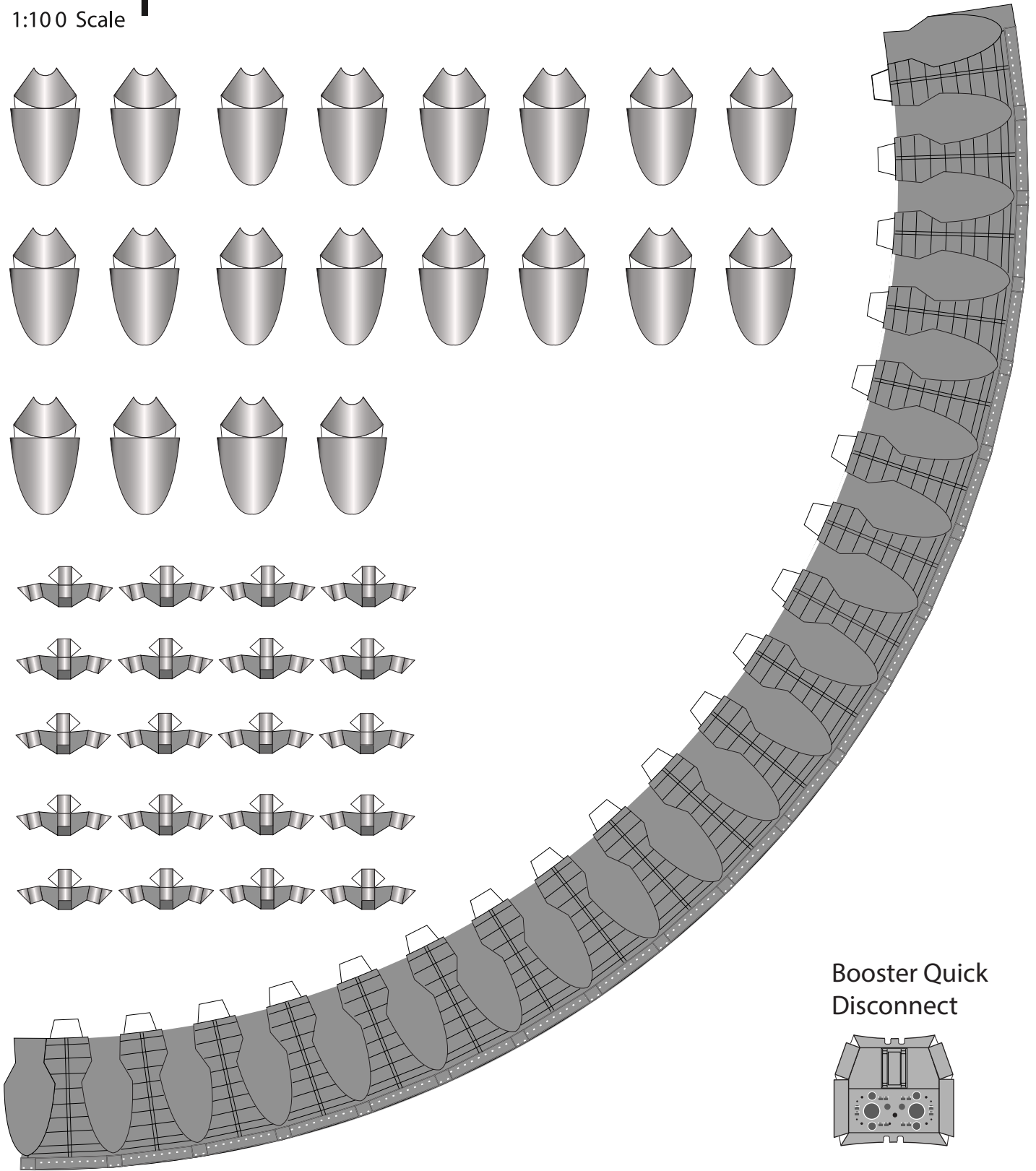
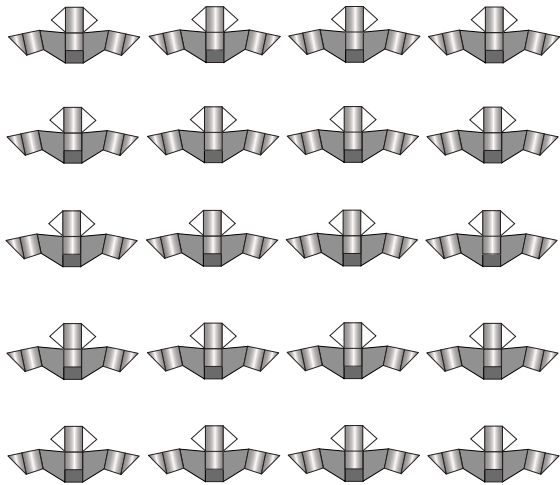
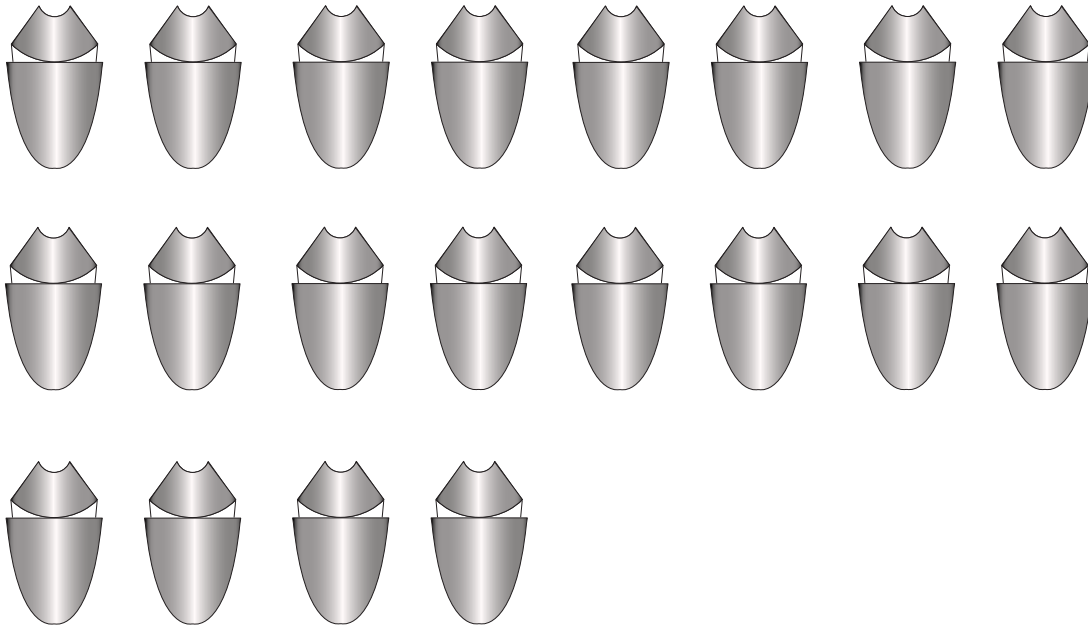

Booster Quick Disconnect

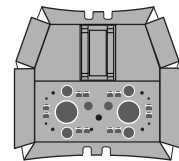

Place 2 magnets on the back to match with magnets from OLM's QD arm



1 cm

1 inch

1:100 Scale

SpaceX Heavy Booster 13

Skirt floor and wall

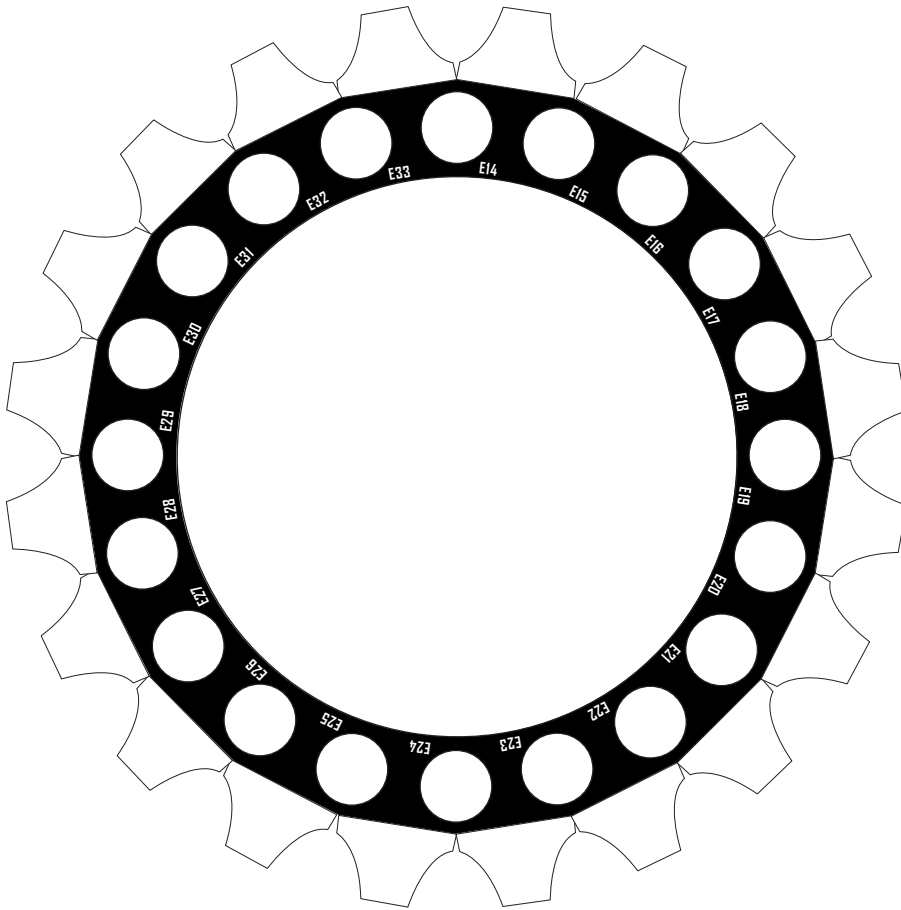

Glue Raptor base

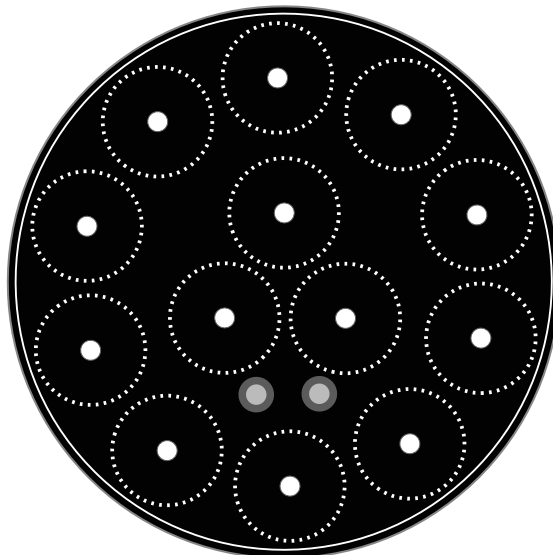

Print on Cardstock (90 lbs)

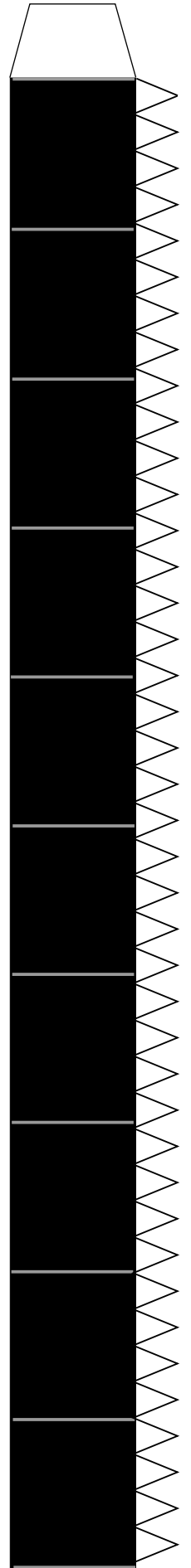



1 cm

1 inch

1:100 Scale

B13 inner Raptor covers

Print on cardstock

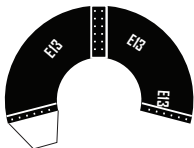
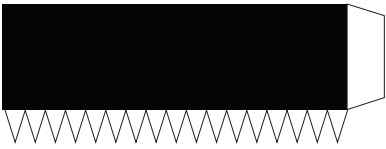
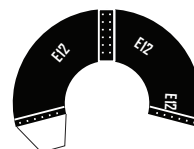
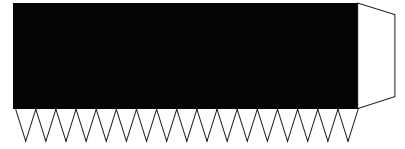
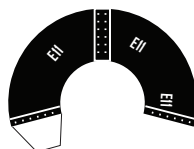
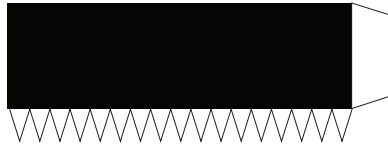
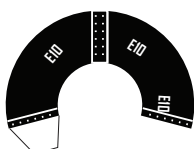
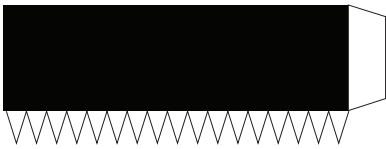
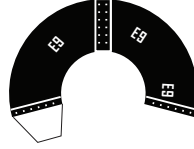
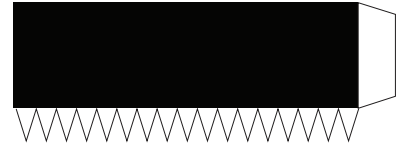
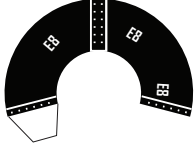
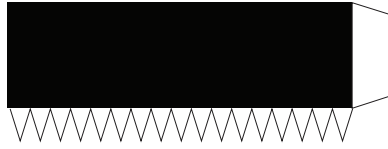
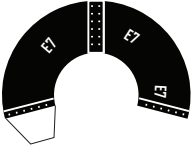
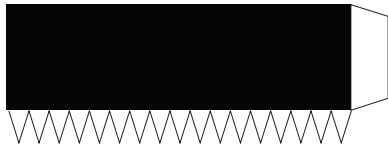
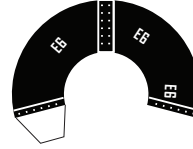
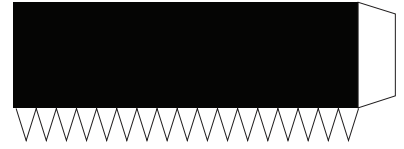
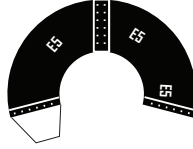
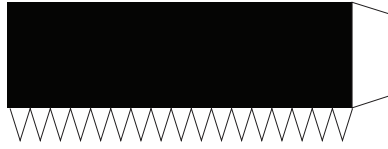
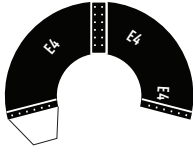
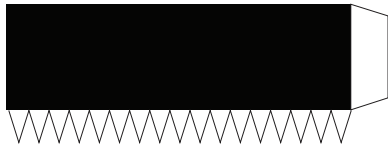
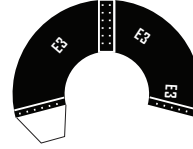
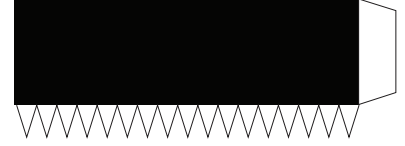
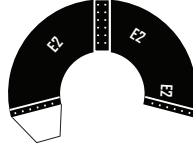
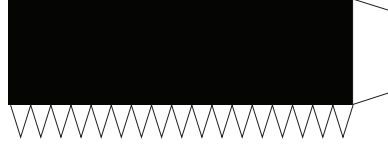
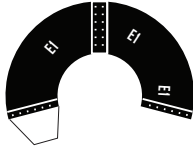
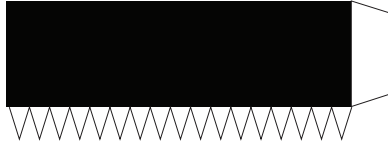



1 cm

1 inch

1:100 Scale

SuperHeavy Raptors

Print on Cardstock (110 lbs)

B13

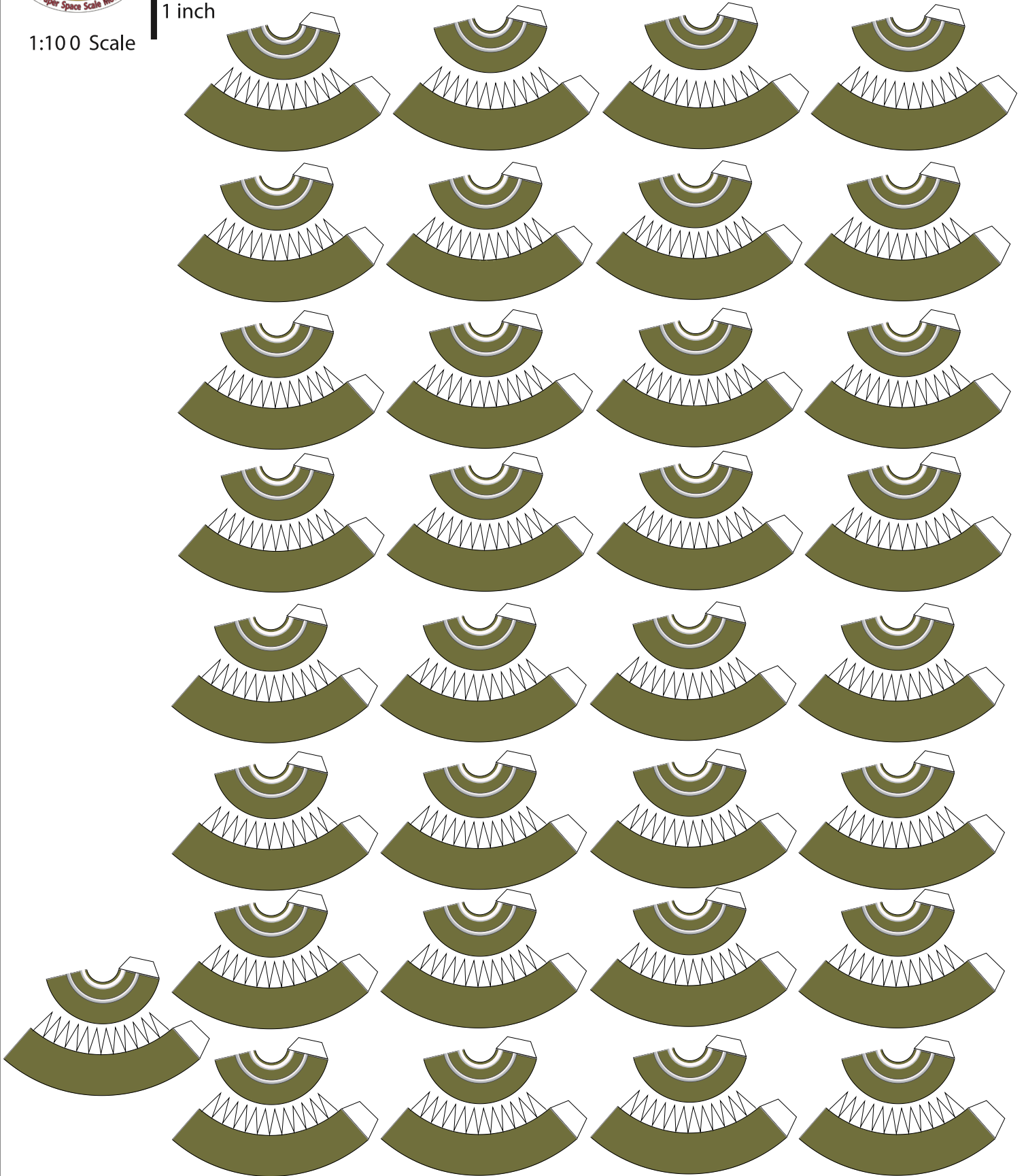



SuperHeavy Raptors BACKPRINT

Print on Cardstock (110 lbs)

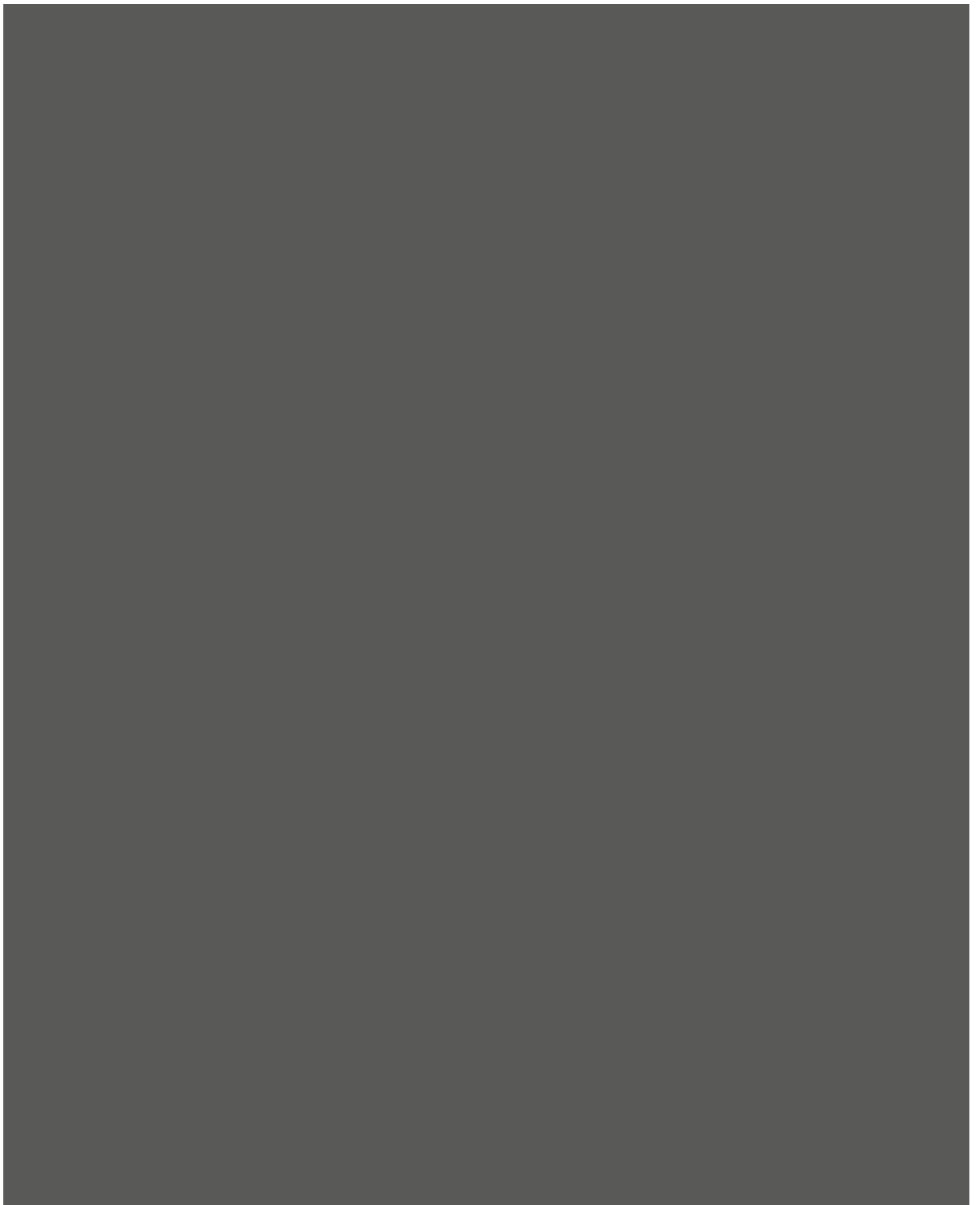



1 cm

1 inch

1:100 Scale

SpaceX Heavy Booster 13

Raptor location

Umbilical side

