

# IM-2 Athena

1:100

Design by Thomas Tannahill

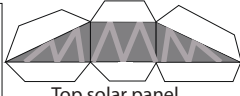

Top solar panel

Details

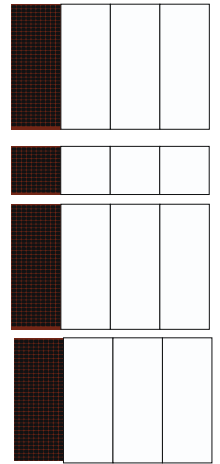
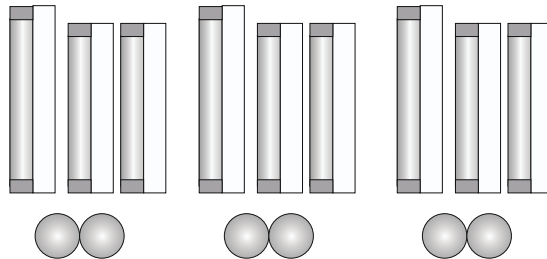
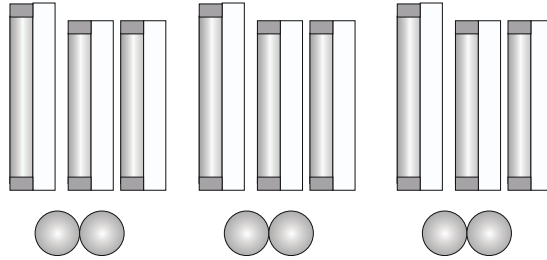
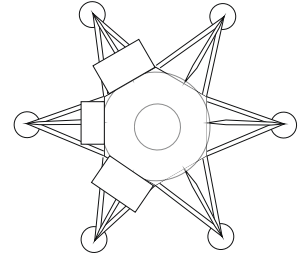
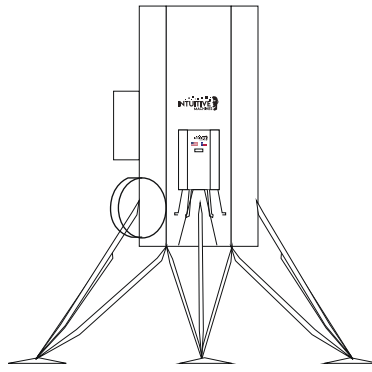
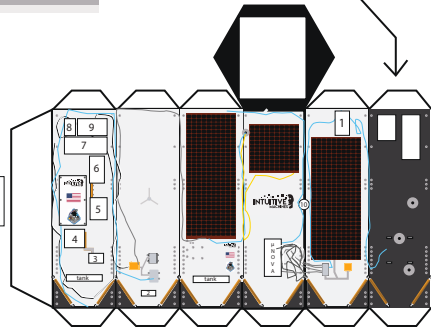
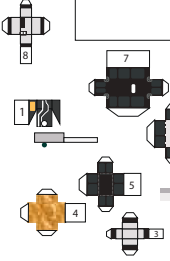

Solar Panels

fuel/oxidiser tanks

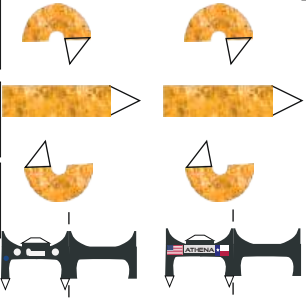
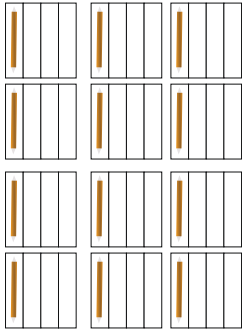

leg supports

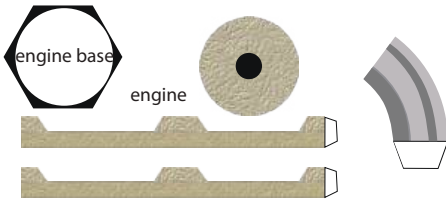

μNOVA

To display with μNOVA detached simply cover the marked panel on the main body with this piece.

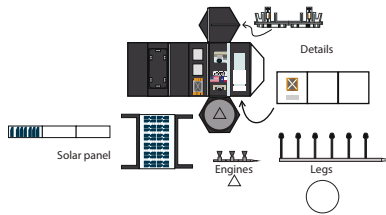

PRIME-1 drill

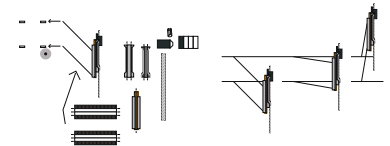

MAPP rover

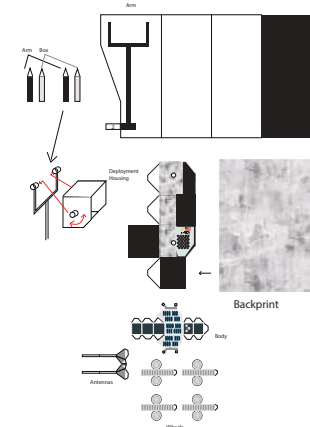

Optionally cover with tinfoil to represent thermal insulation