



1 cm
1 inch

Ariane 6 Fairing Ogive

Print on Cardstock (110 lb)

1:96 Scale

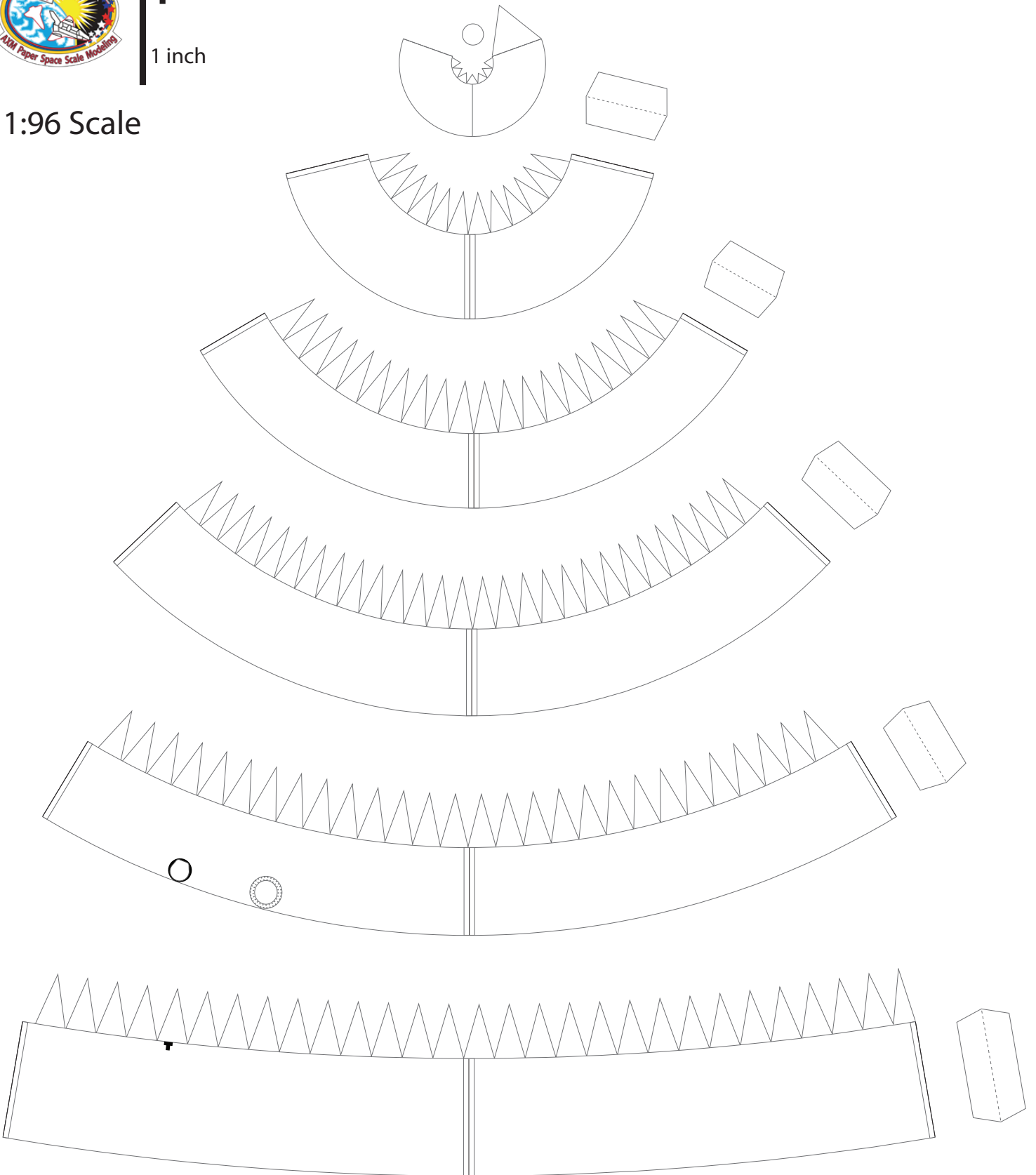



1 cm
1 inch

Print on Cardstock (110 lb)

Ariane 6 Fairing/Upper Stage

VA263

1:96 Scale

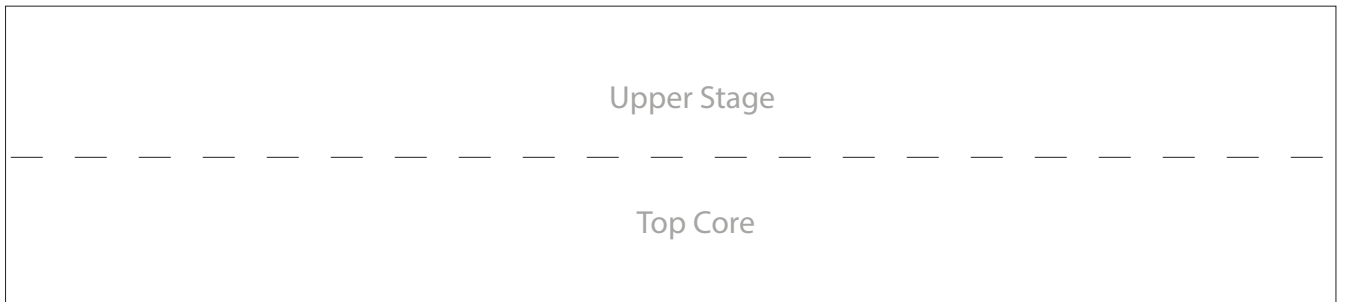
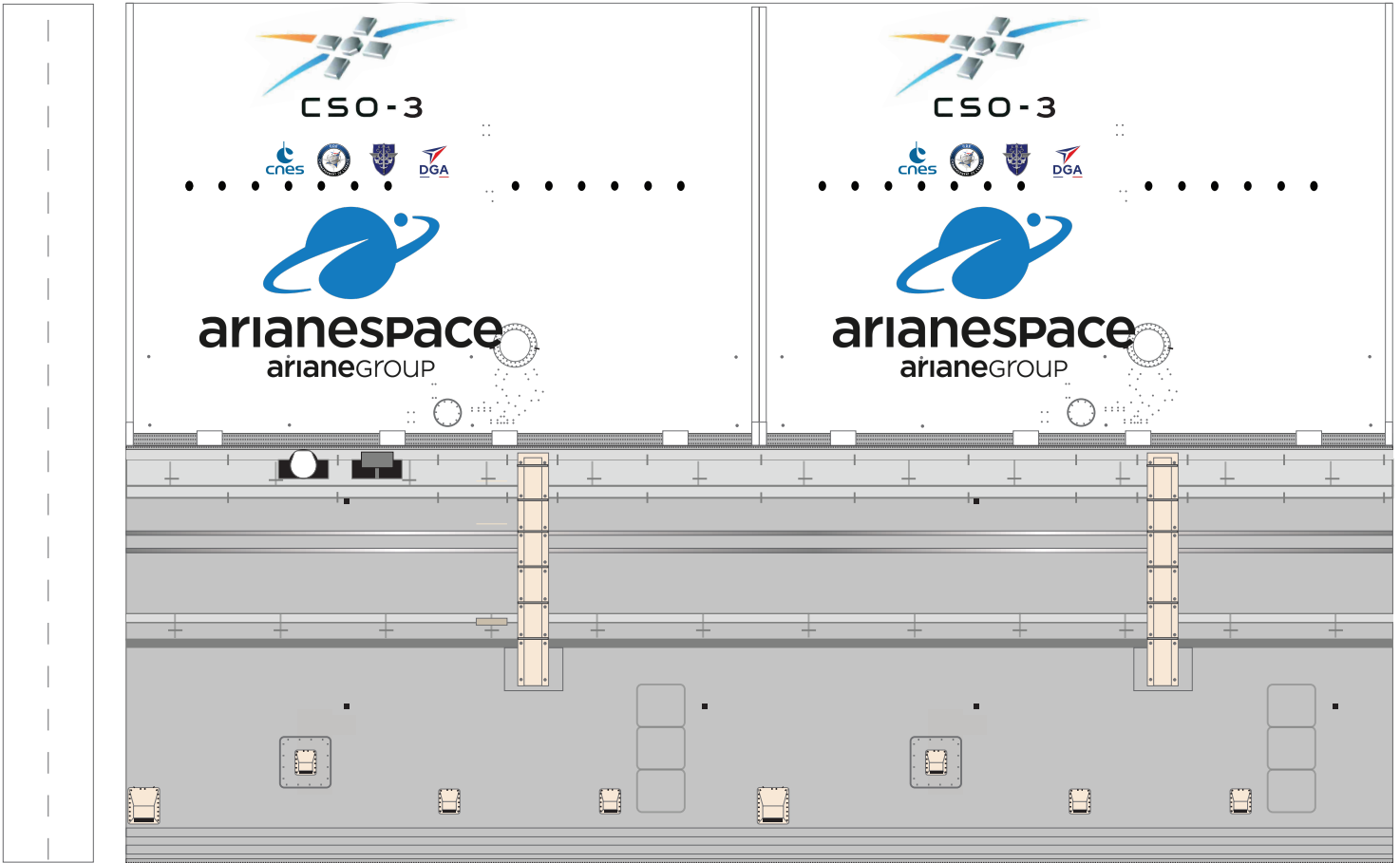
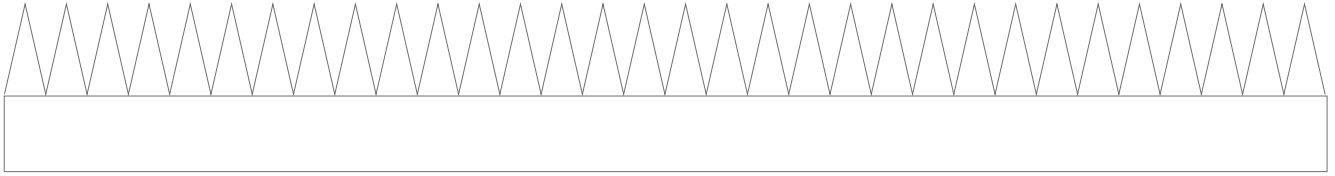

Upper Stage

Top Core



1 cm
1 inch

Ariane 6 top Core

Print on Cardstock (110 lb)

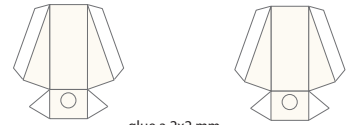

glue a 2x2 mm rod (cottonswab)

1:96 Scale

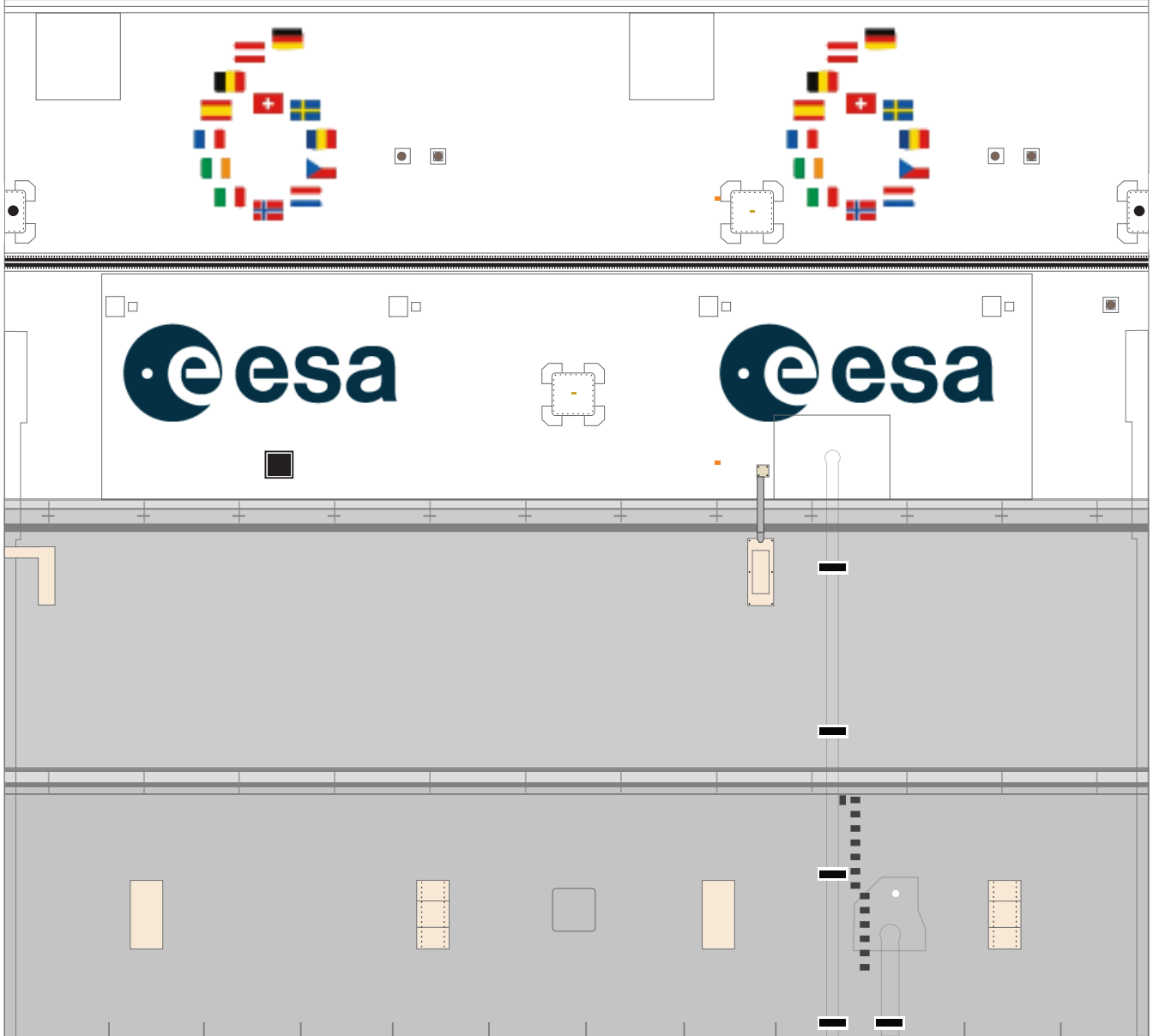

Top Core

Bottom Core



1 cm
1 inch

Ariane 6 bottom Core

Print on Cardstock (110 lb)

1:96 Scale

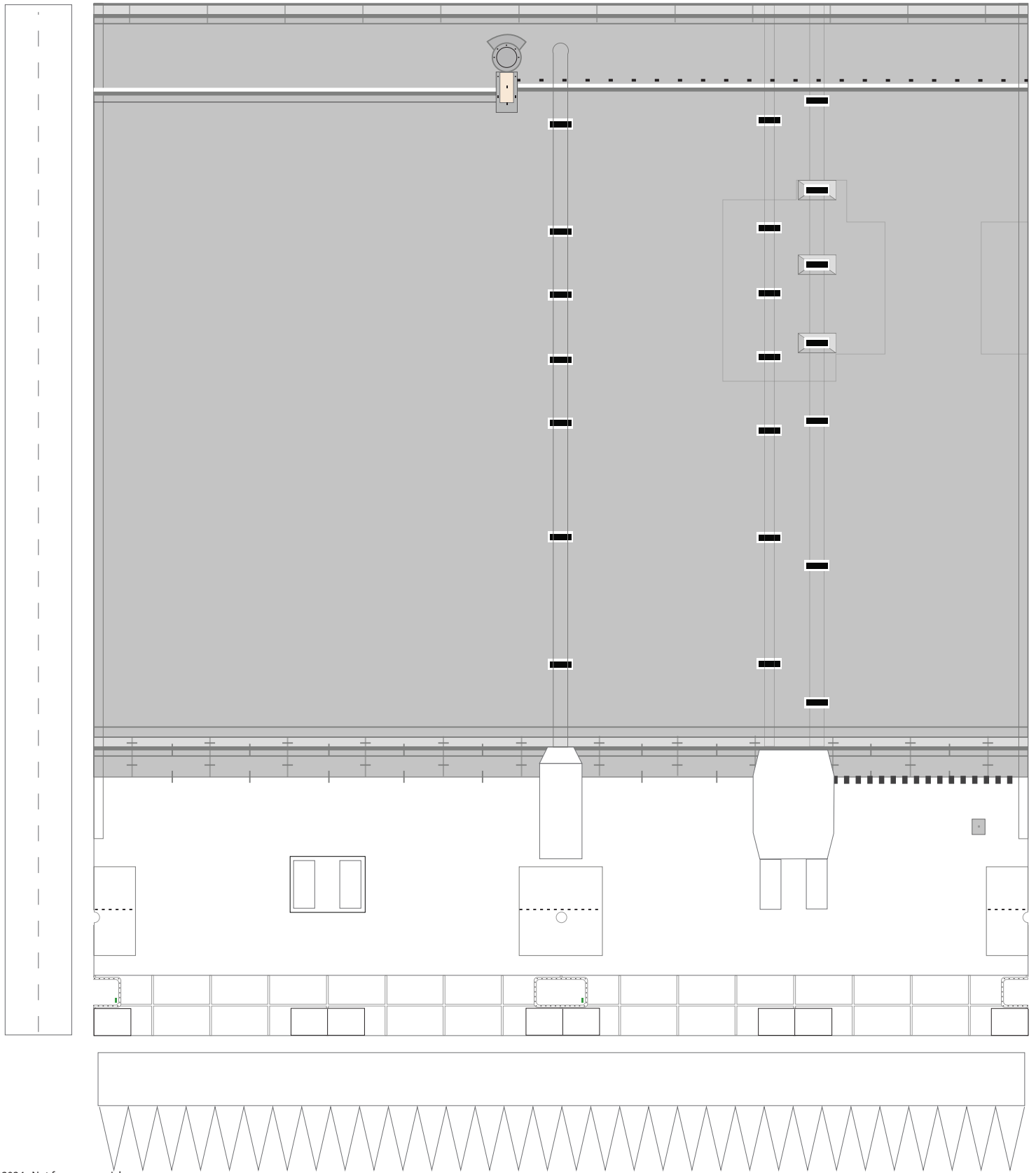
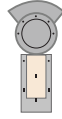



1 cm
1 inch

Ariane 6 Engine section

Print on Cardstock (110 lb)

Vulcain 2.1

1:96 Scale

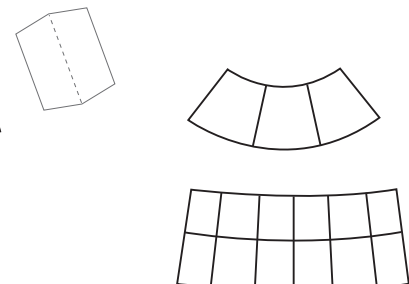
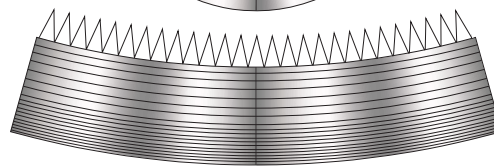
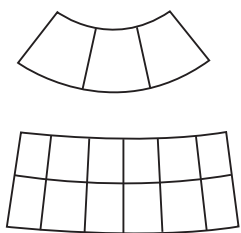
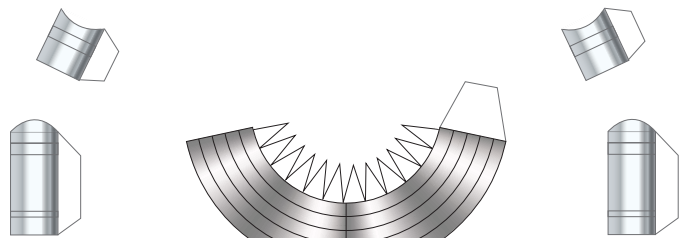
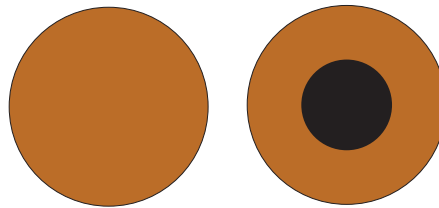
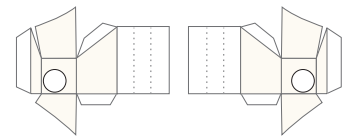
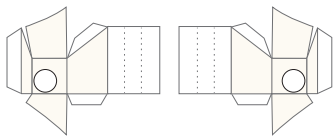
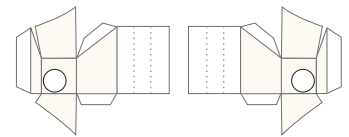
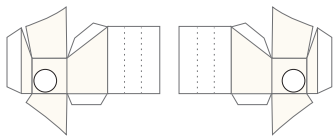
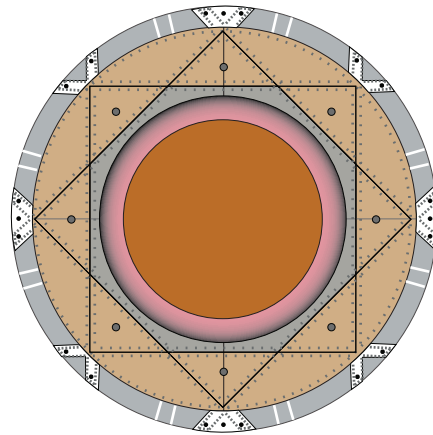
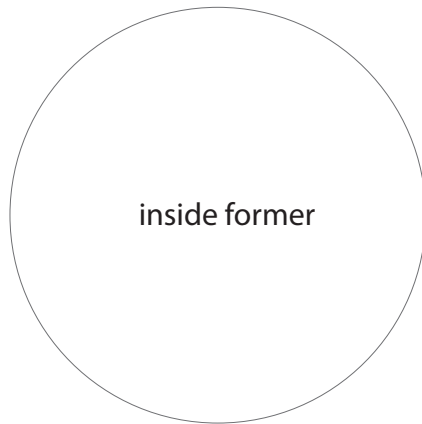

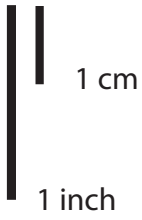

Print on Cardstock (110 lb)

1:96 Scale

Umbilical tower

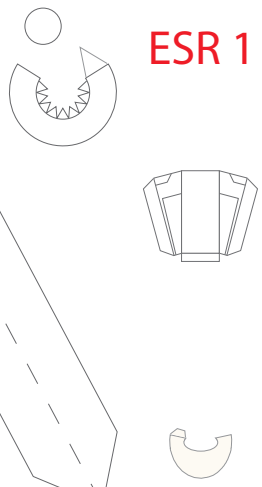
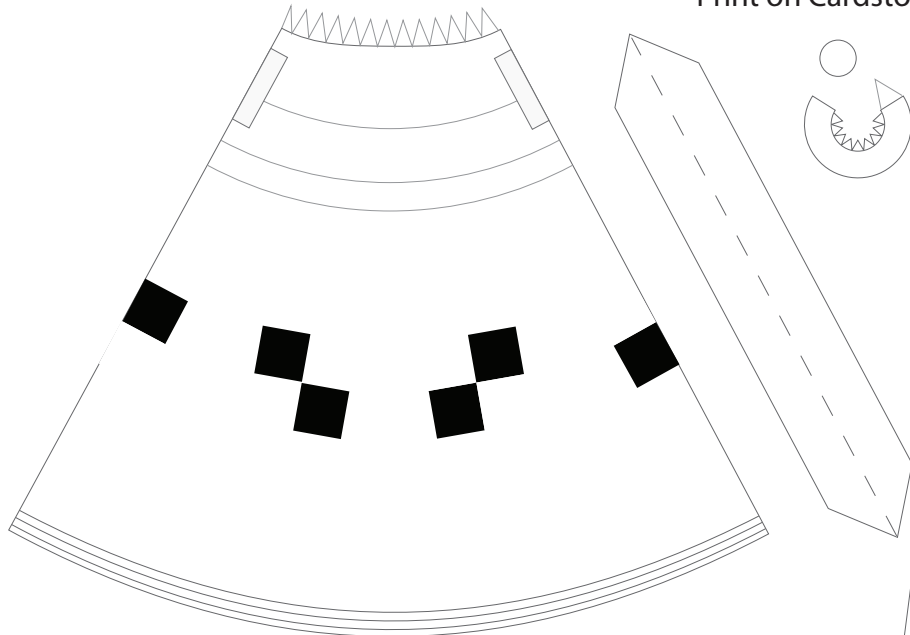
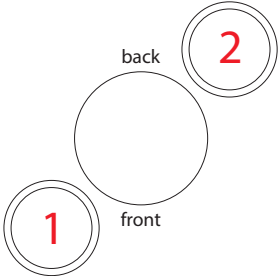

ESR 1

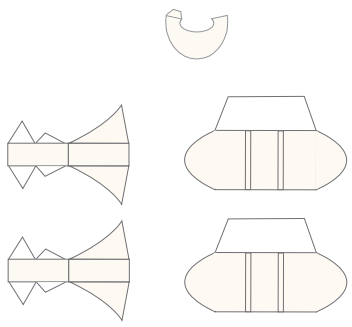
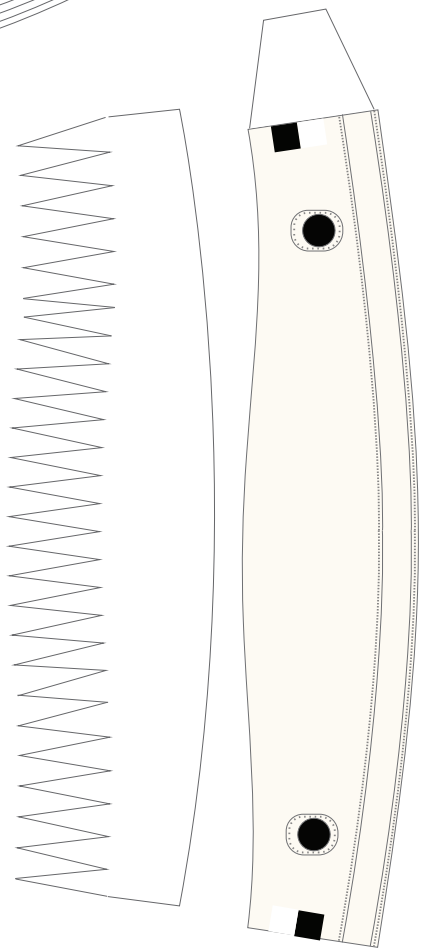
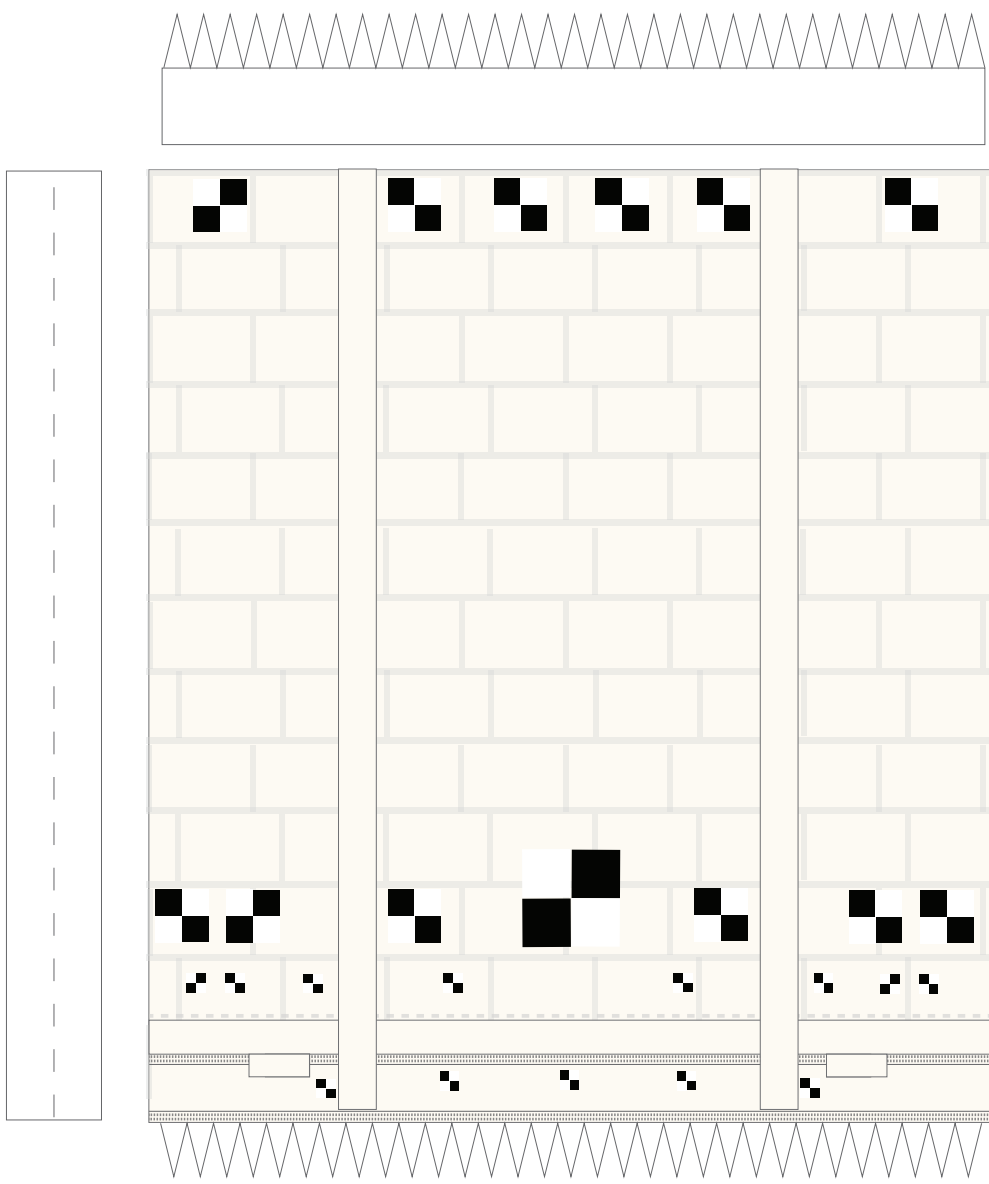



1 cm
1 inch

Print on Cardstock (110 lb)

1:96 Scale

Umbilical tower

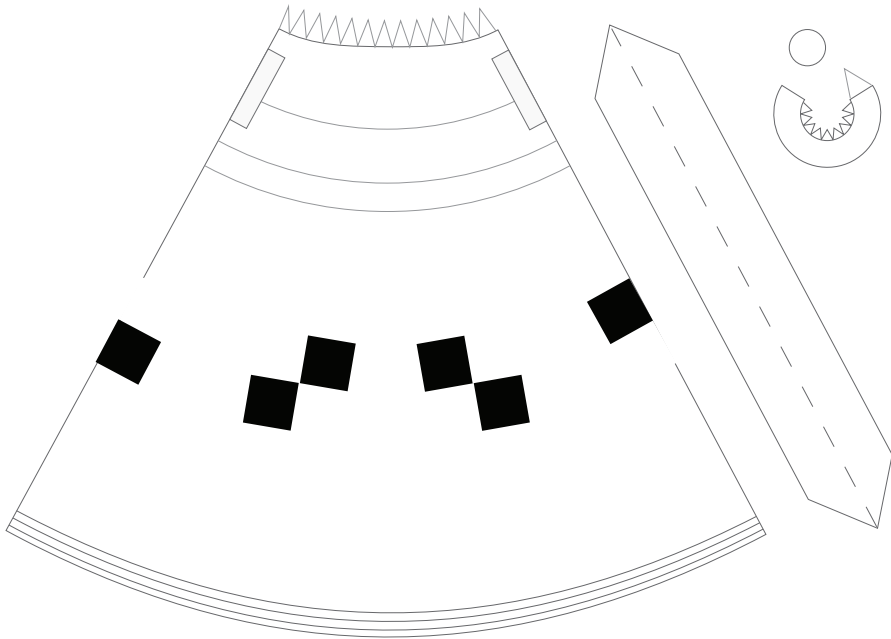
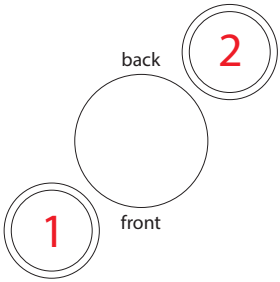

ESR 2

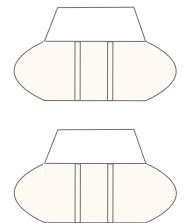
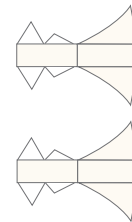
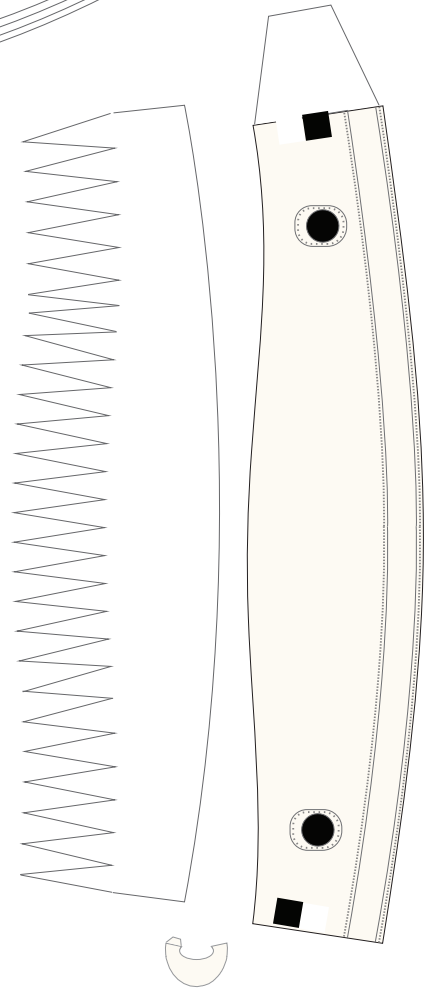
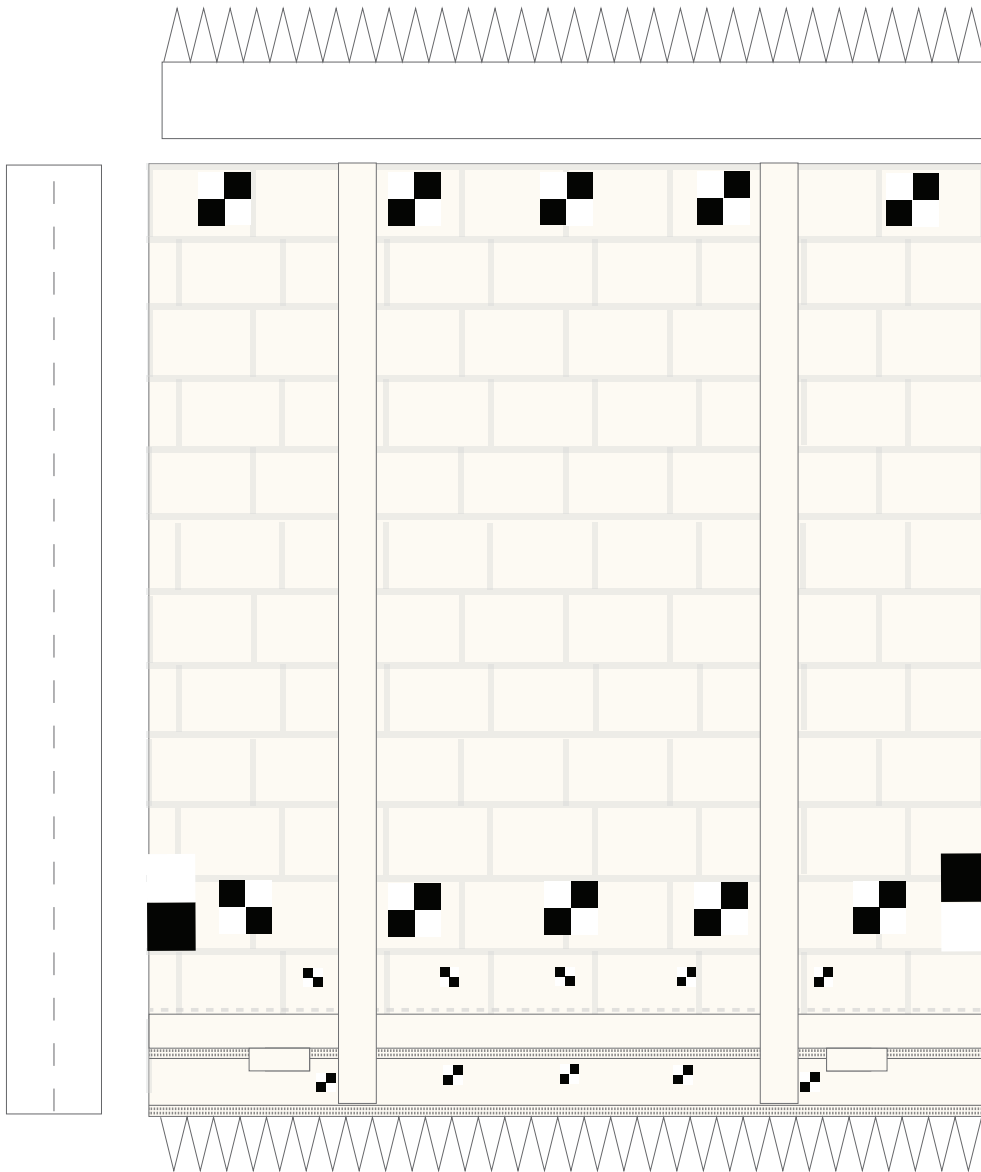
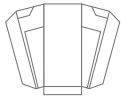



1:96 Scale

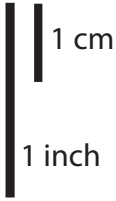

Ariane 6

Print on Cardstock (110 lb)

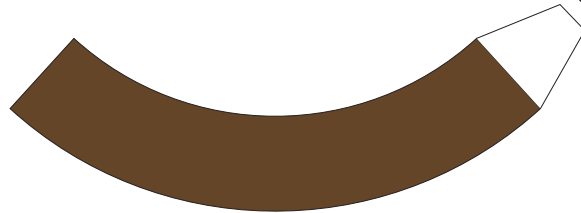
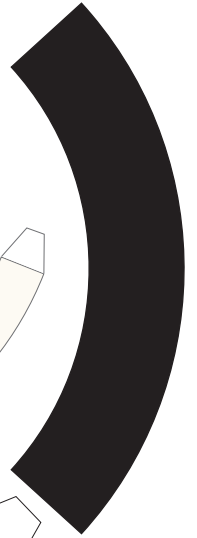
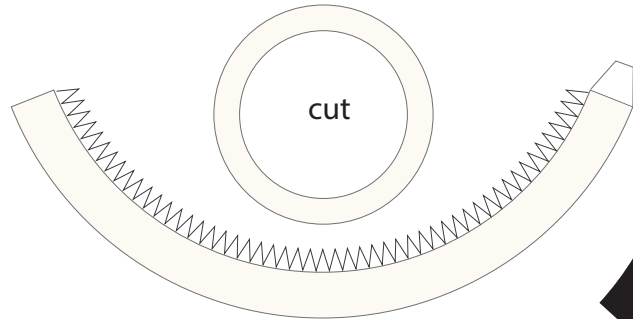
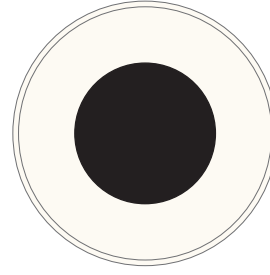
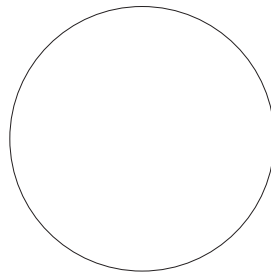
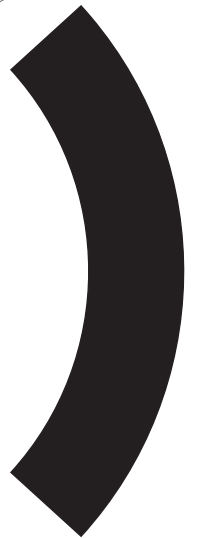
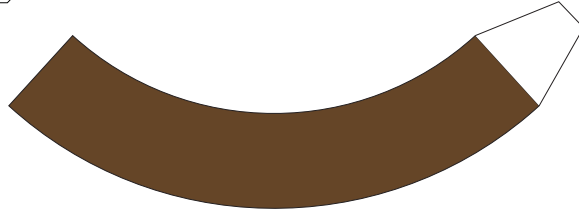
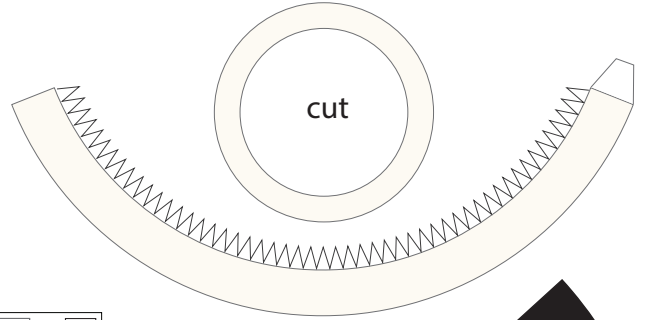
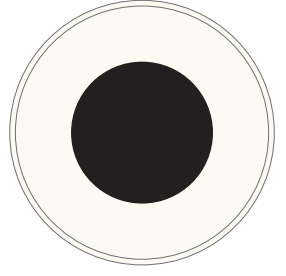
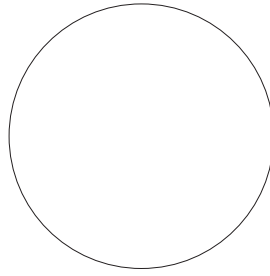
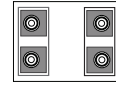
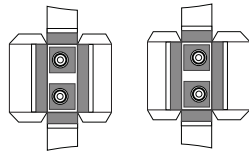
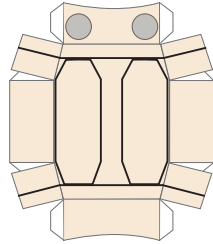
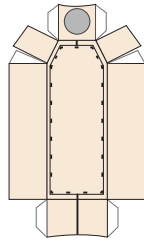
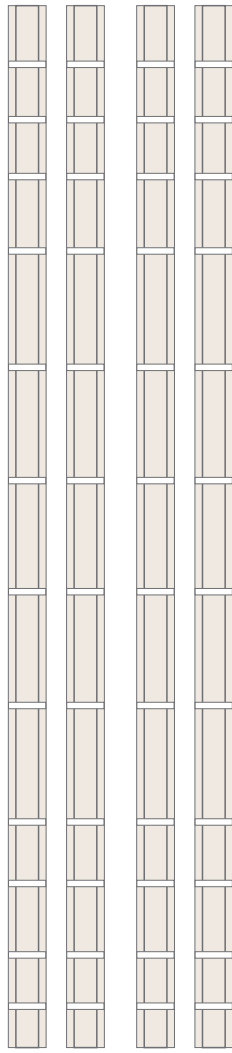
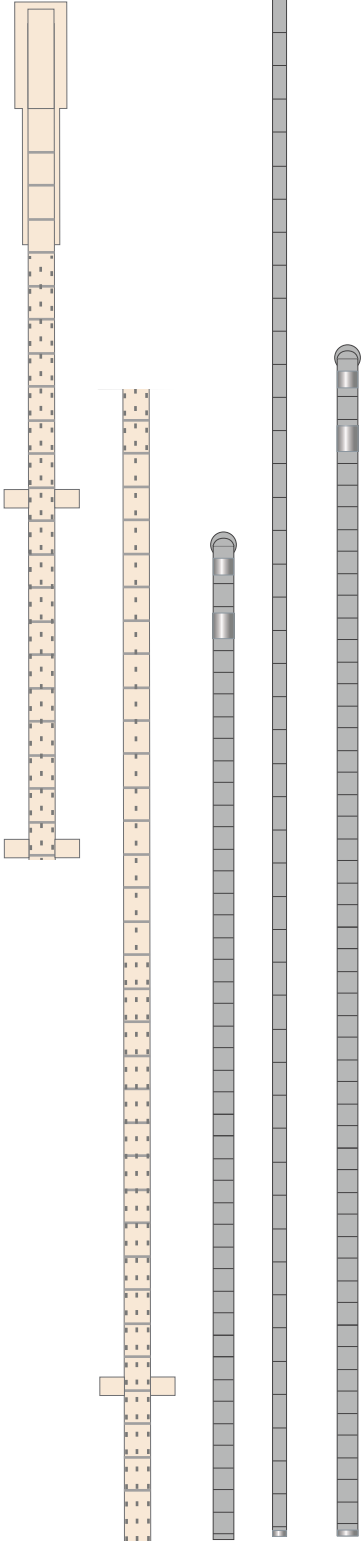



1 cm

1 inch

Print on Cardstock (90 lbs)

Revised

1:100 Scale

ESR booster positions

