

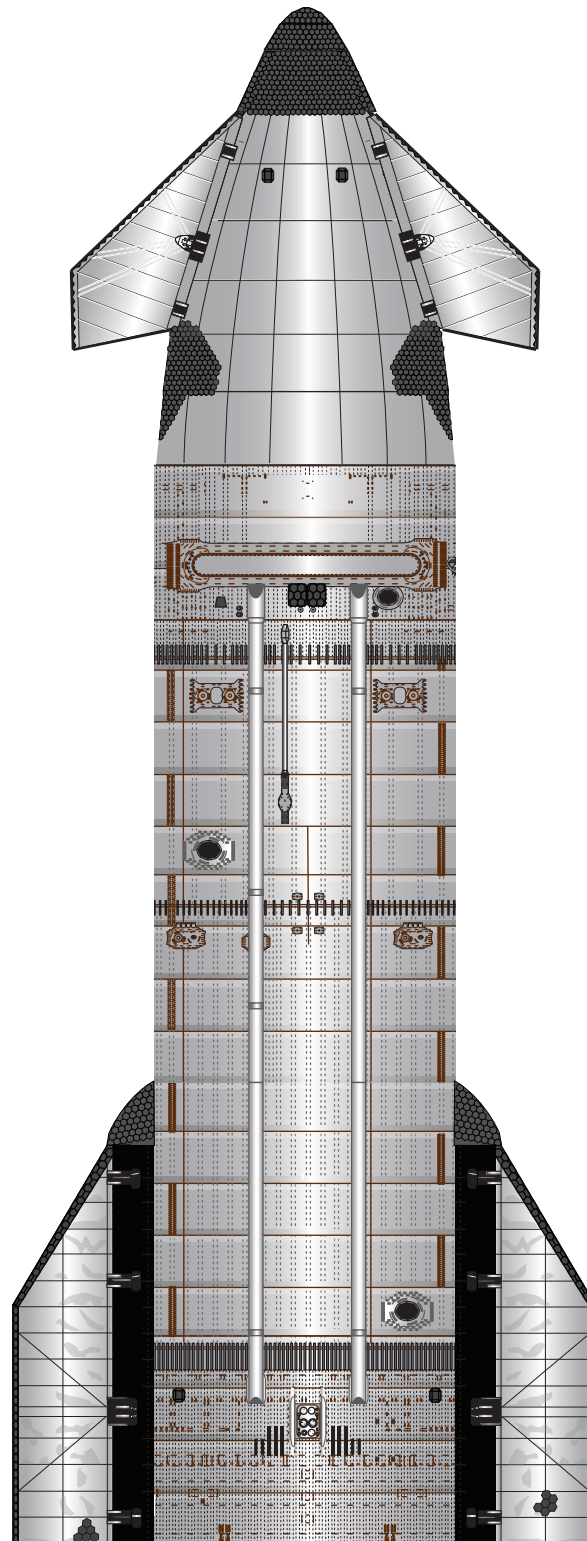

S33

1:100 Scale



S
T
A
R
S
H
I
P

Designed by Alfonso X Moreno
©2025 Not for commercial use



SpaceX Starship S33

Print on Cardstock (110 lbs)

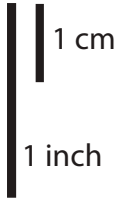

1:100 Scale

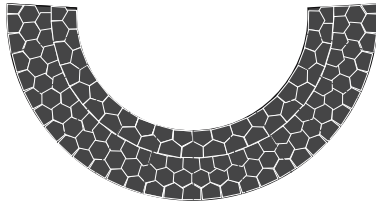

ring 7

Glue tip of flap supports

ring 9



ring 8

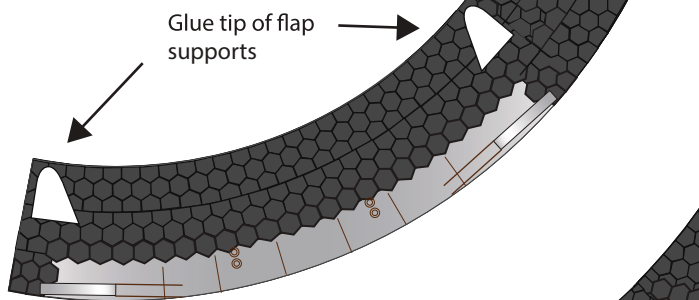

ring 5

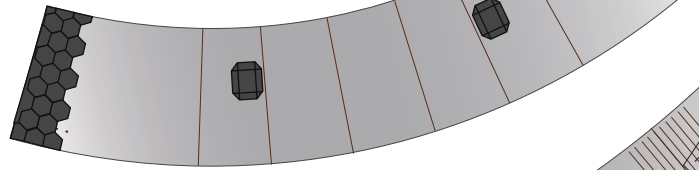

ring 4

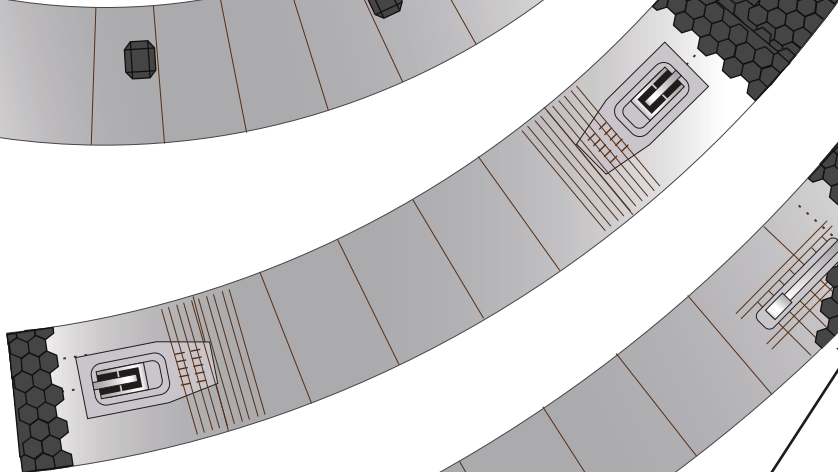

ring 3

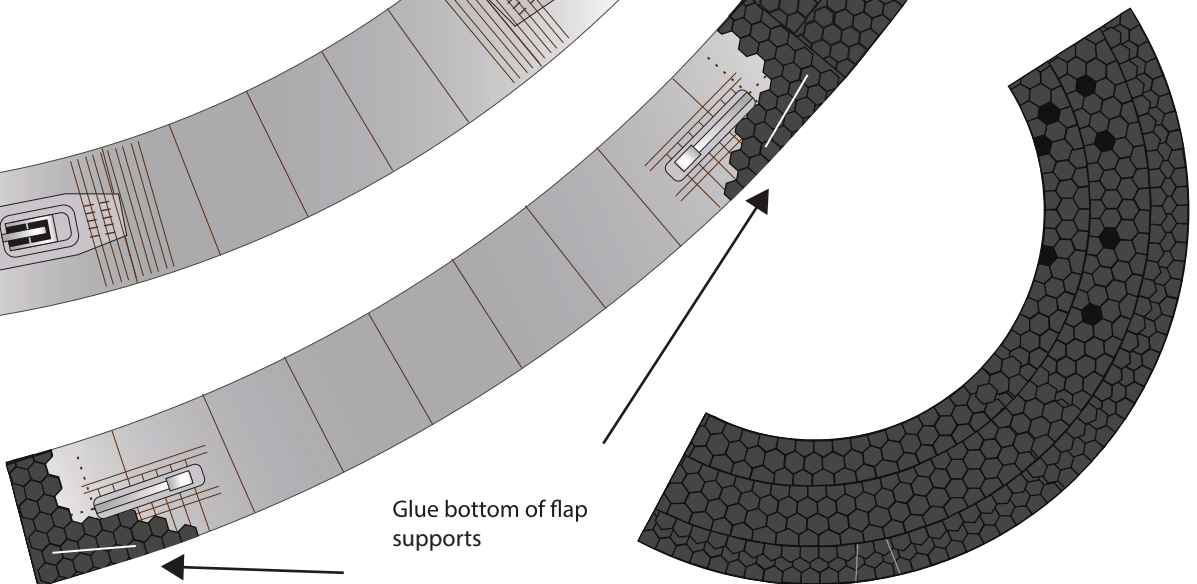

Glue bottom of flap supports

ring 2

ring 6





1:100 Scale

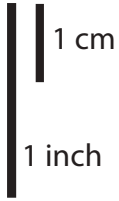

SpaceX Starship S33

Print on Cardstock (110 lbs)

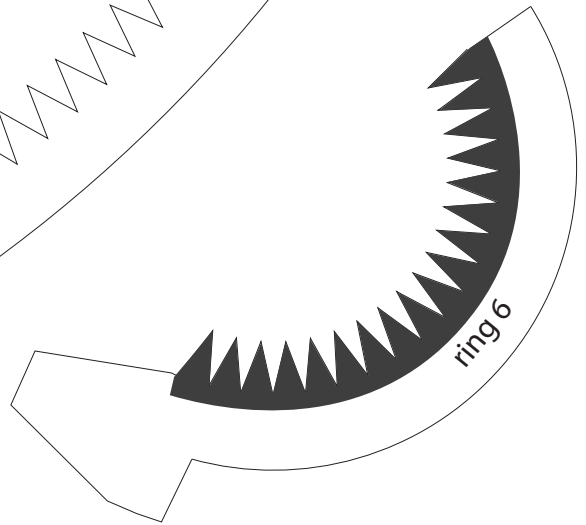
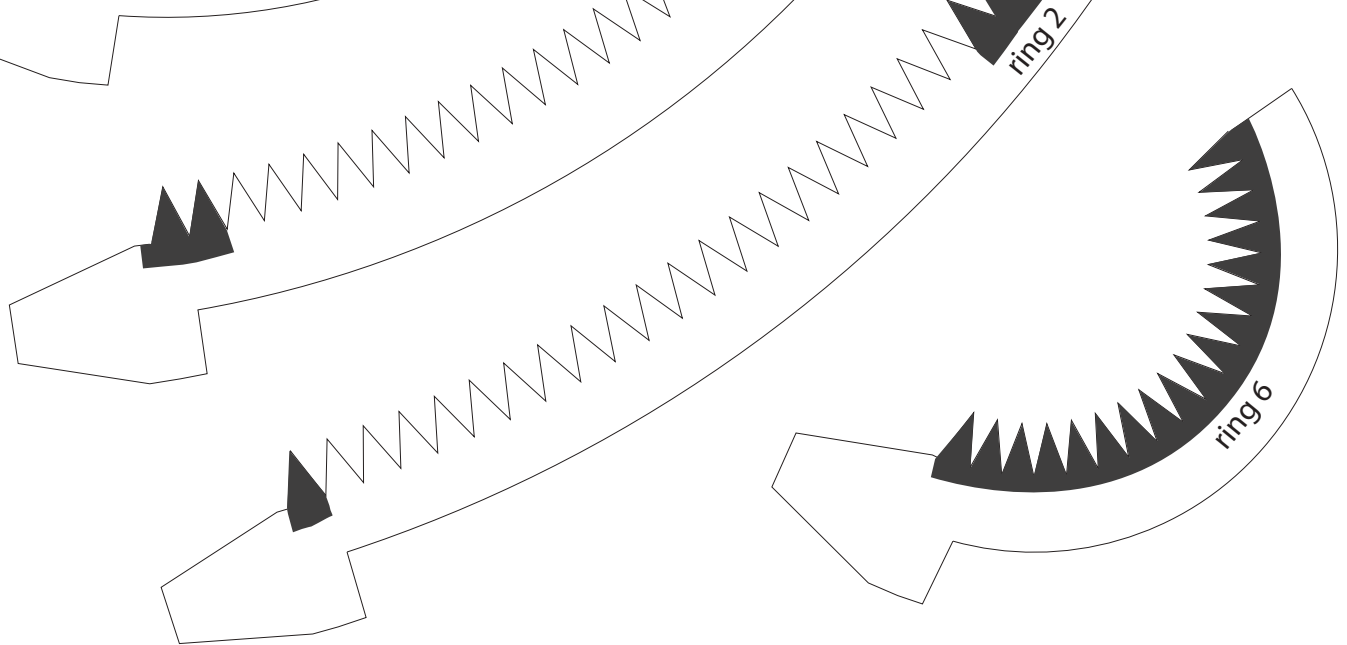
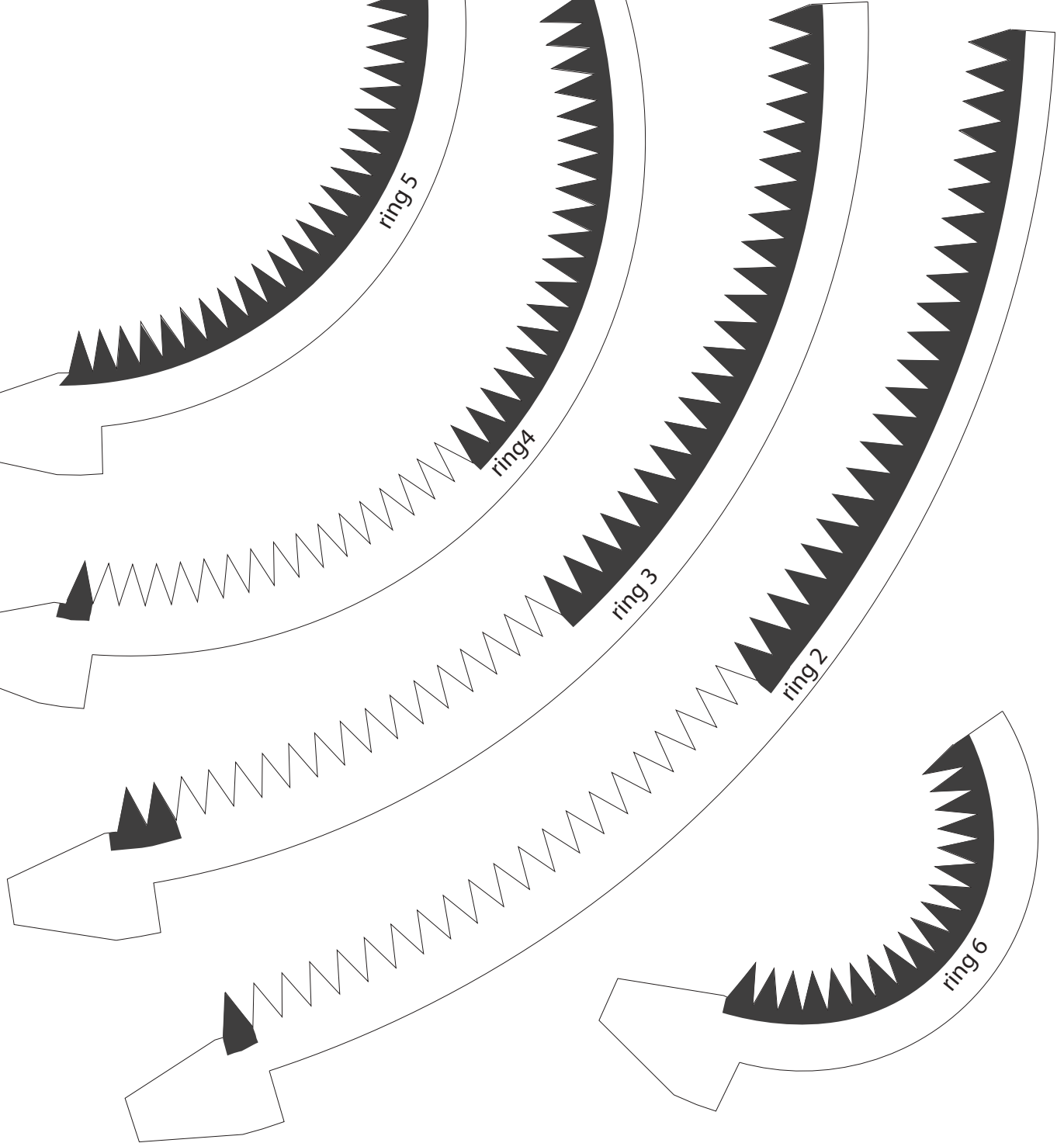
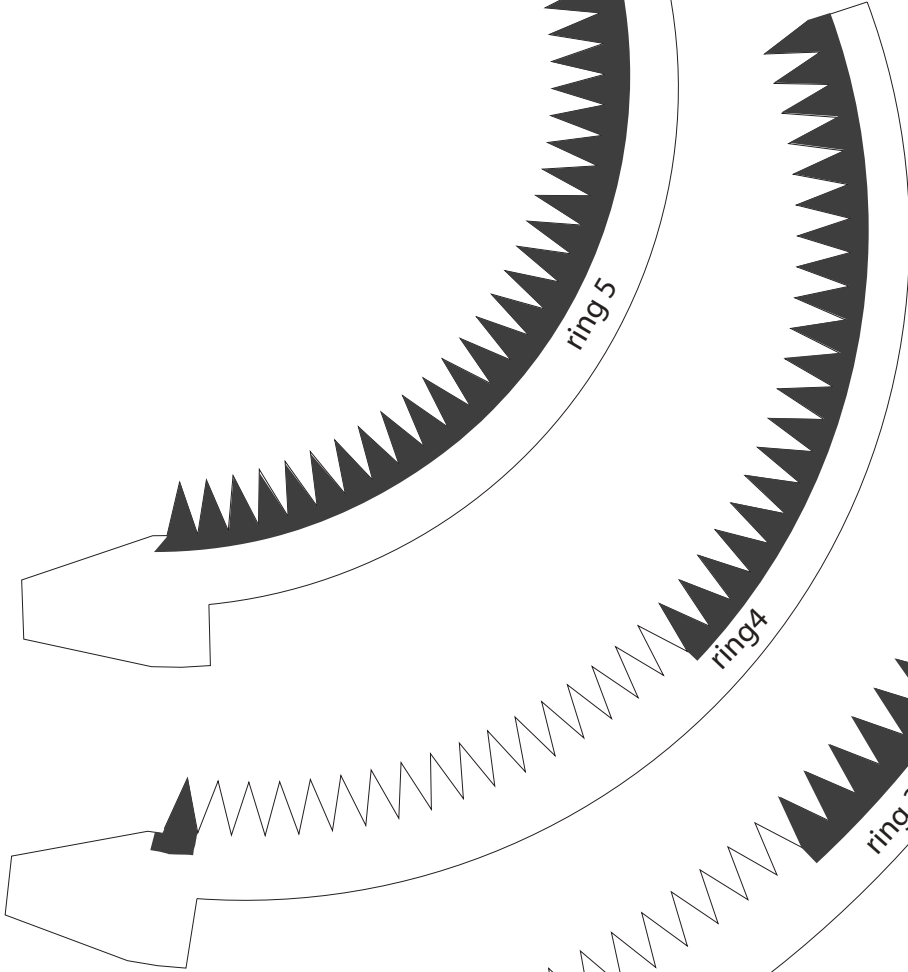
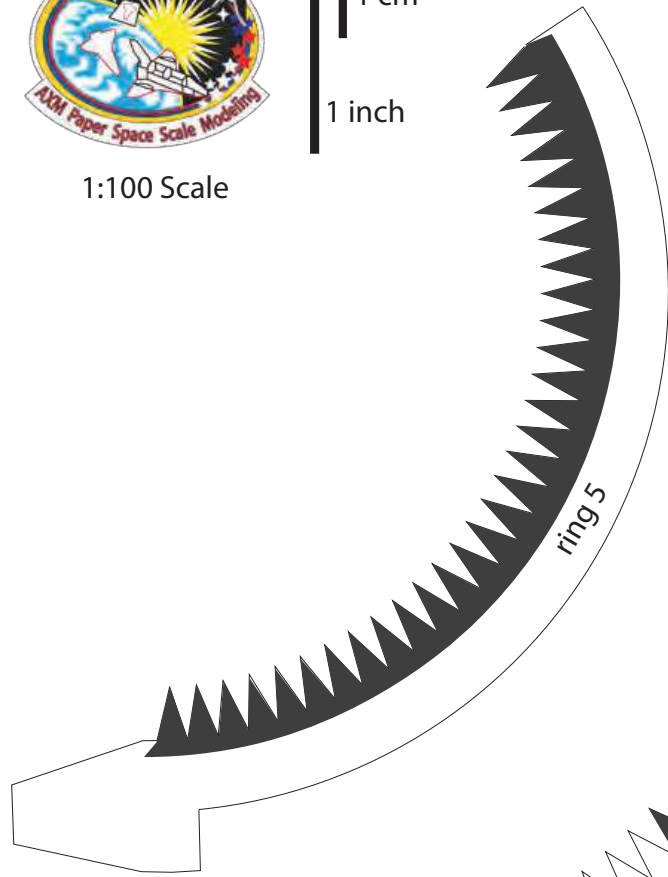
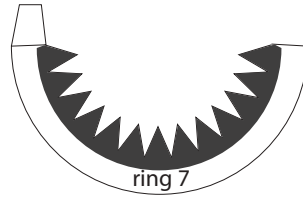

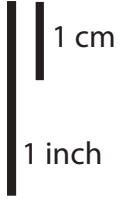

SpaceX Starship S33

Print on Cardstock (110 lbs)

1:100 Scale





1:100 Scale

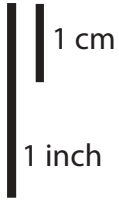

SpaceX Starship S33

Print on Cardstock (110 lbs)

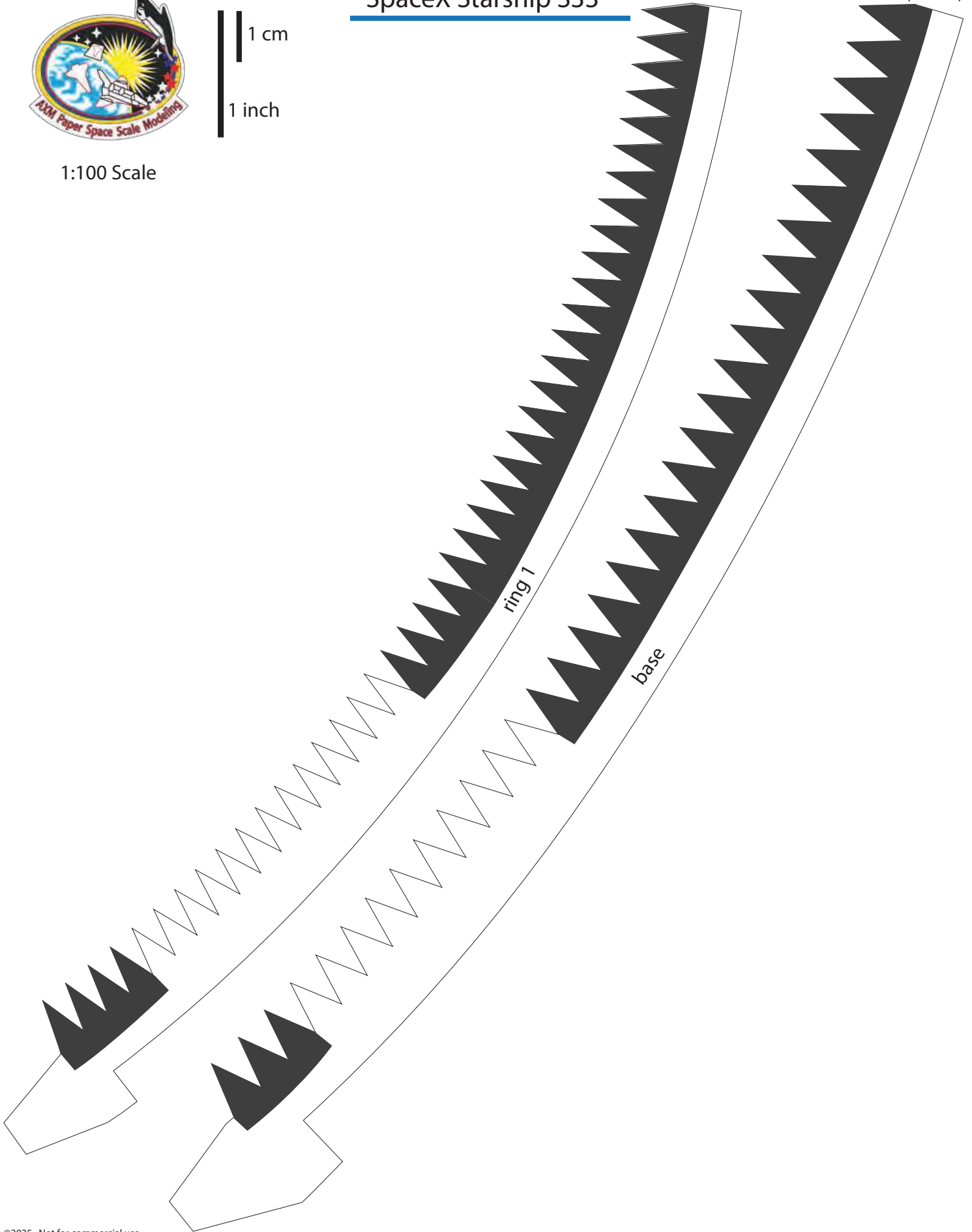



1:100 Scale

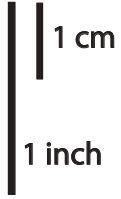

SpaceX Starship S33

Print on Cardstock (110 lbs)

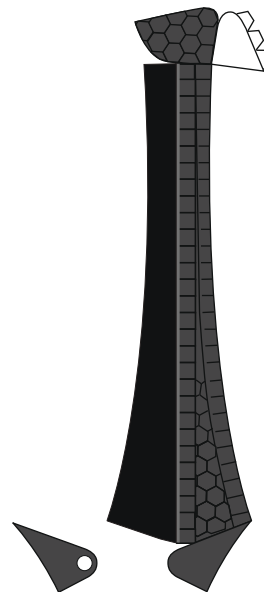
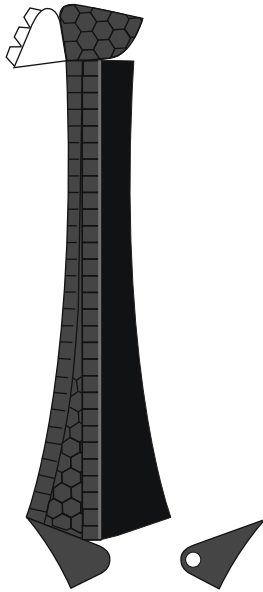
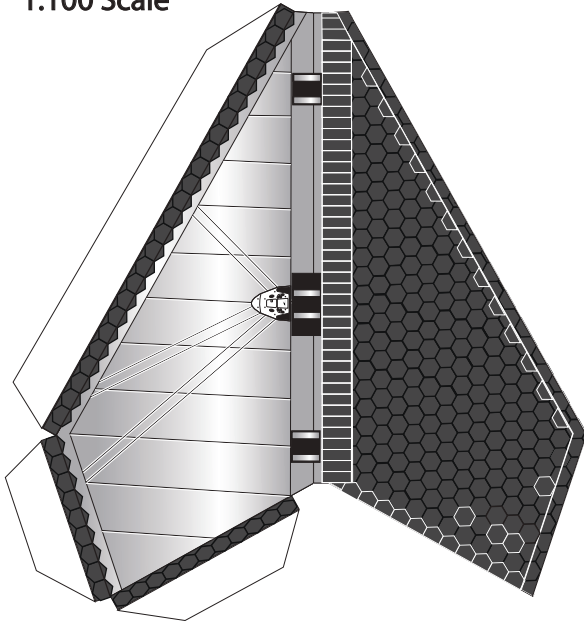



1:100 Scale



SpaceX Starship S33

Print on Cardstock (110 lbs)

Nosecone-body 3 ring stack

Catch pin

Catch pin

Umbilical side

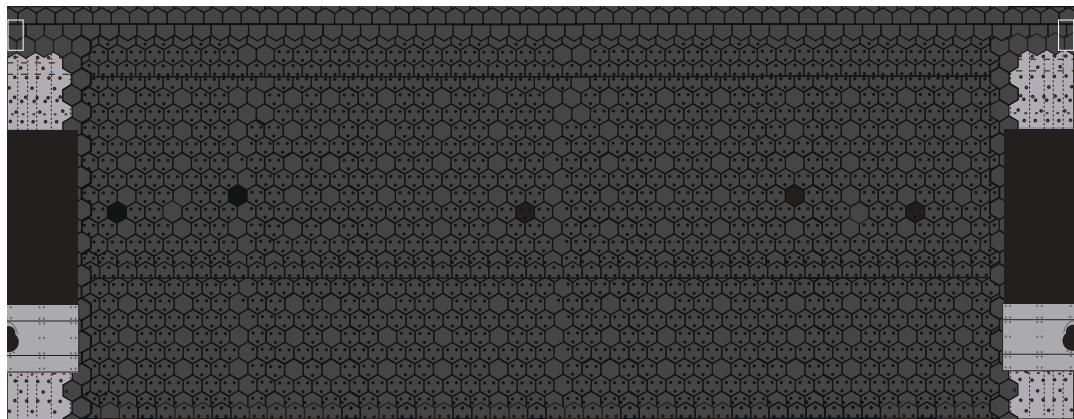
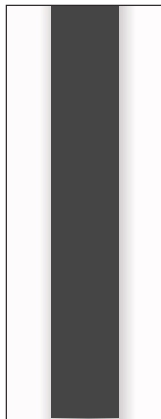
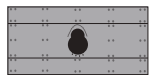
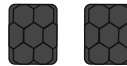
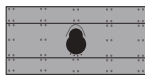
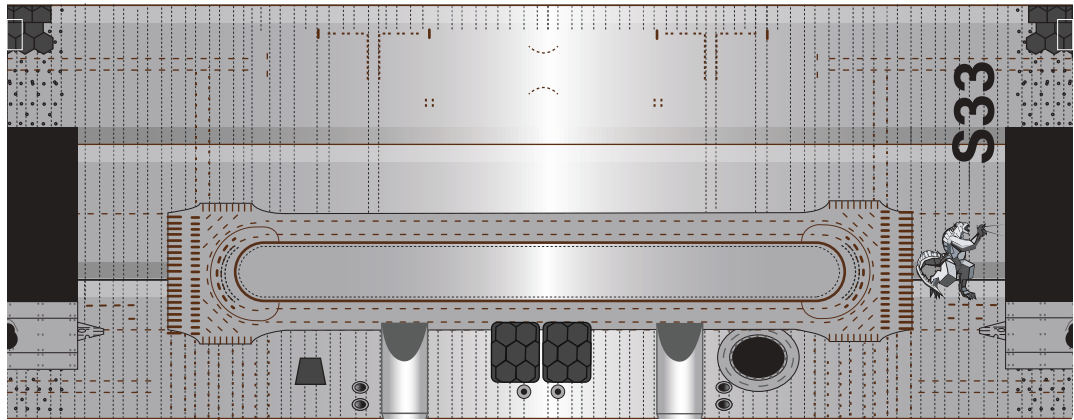
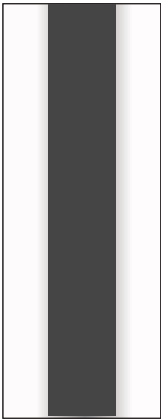
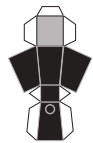
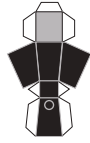

Connectors for 3 ring stack and body





1:100 Scale

1 cm
1 inch

SpaceX Starship S33

Back top

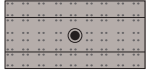
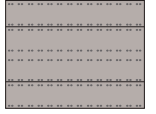
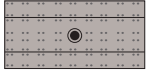
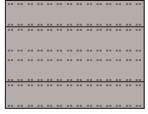
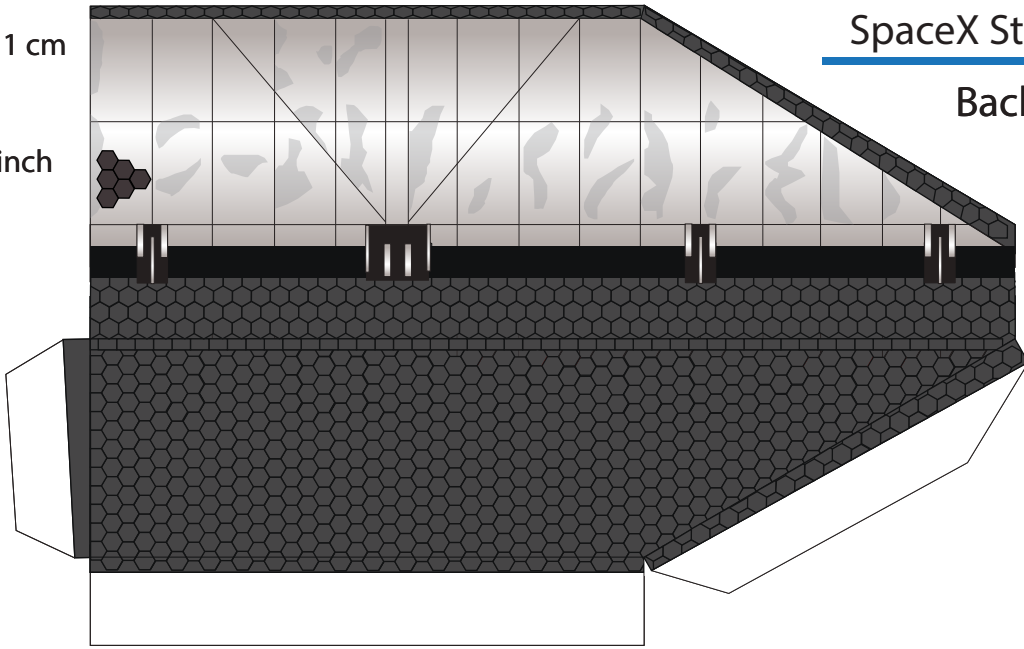

Print on Cardstock (110 lbs)

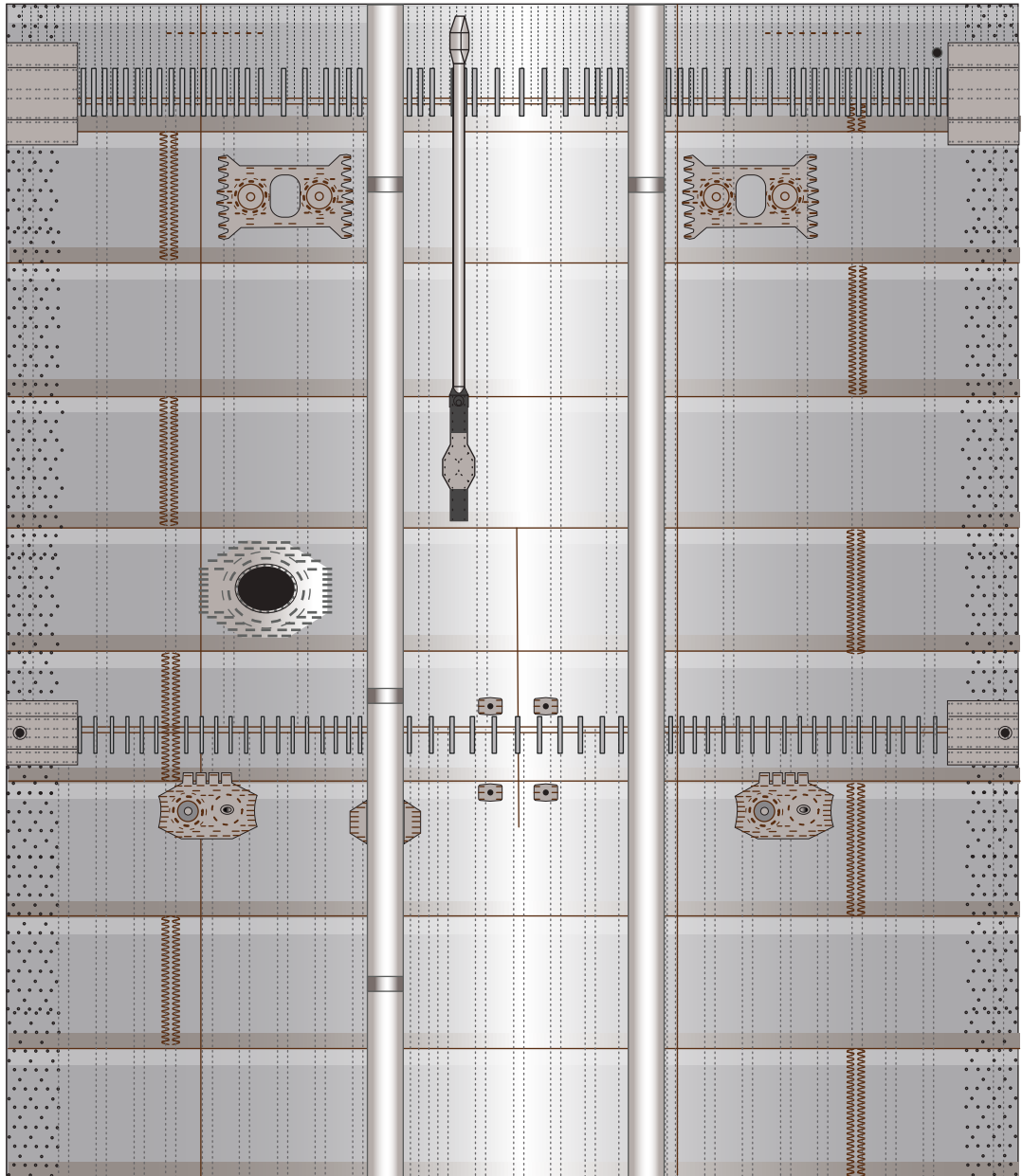
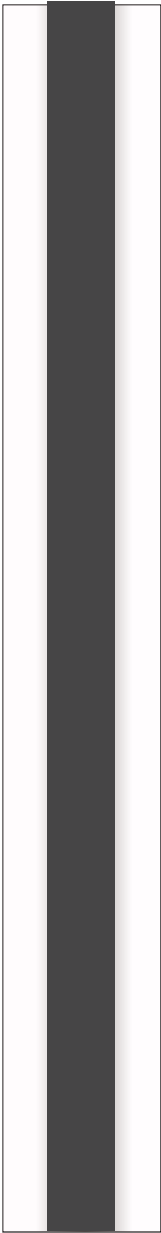



1:100 Scale

1 cm

1 inch

SpaceX Starship S33

Belly top

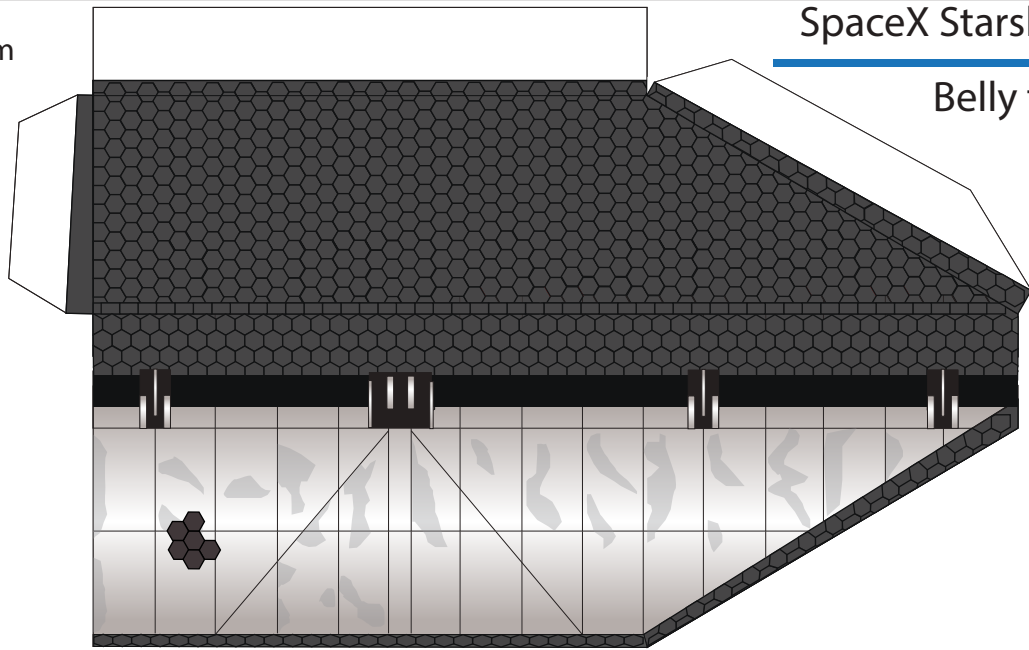

Print on Cardstock (110 lbs)

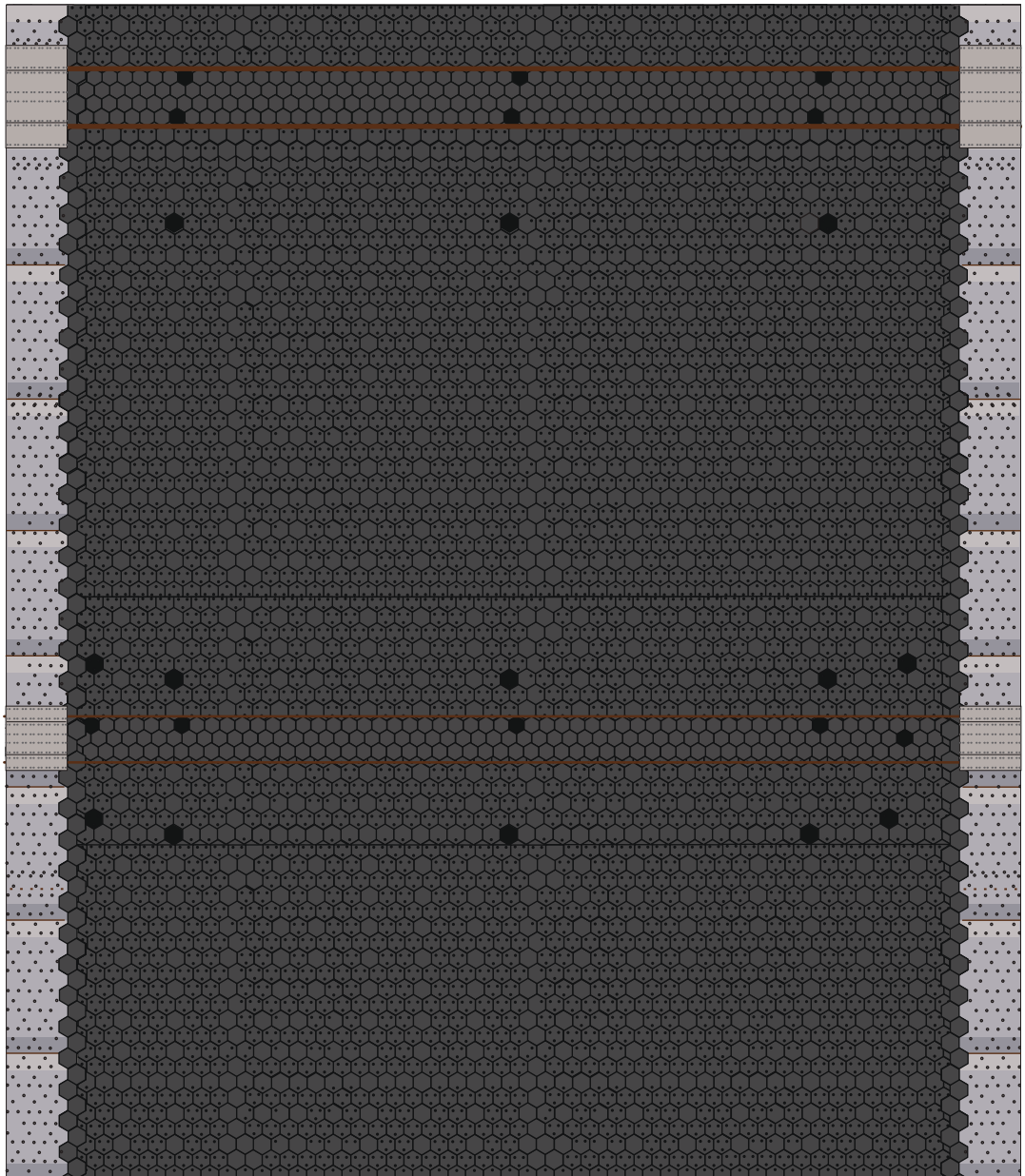
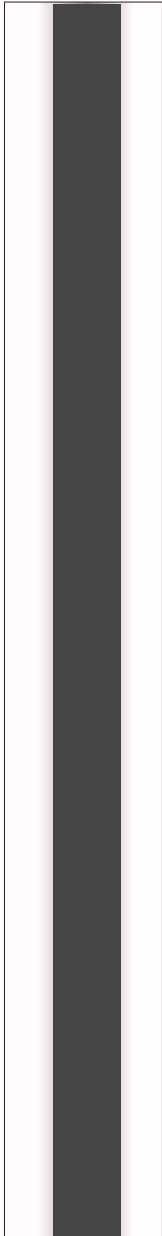



1:100 Scale

1 cm
1 inch

SpaceX Starship S33

Print on Cardstock (110 lbs)

Back bottom

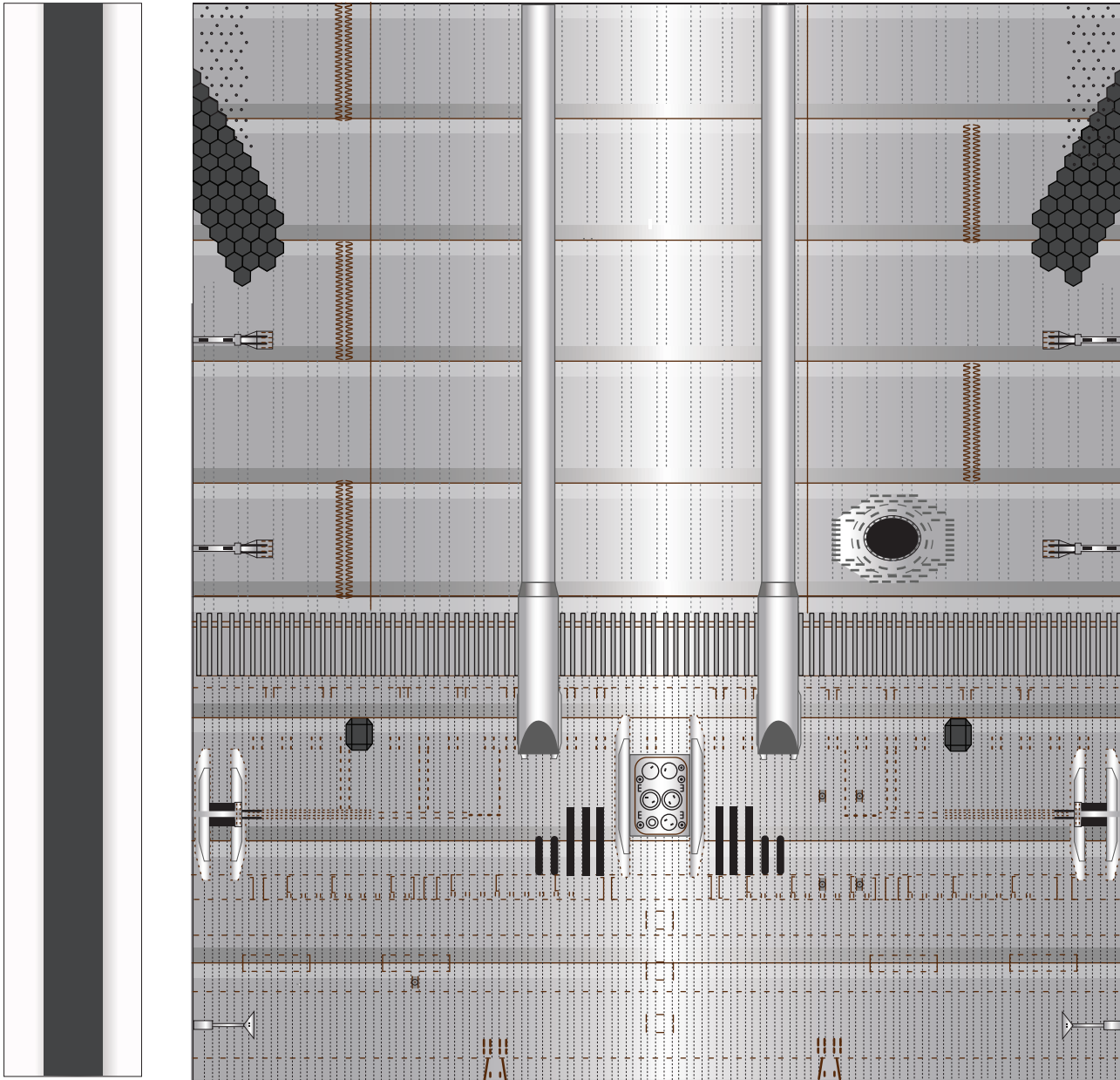



1:100 Scale



SpaceX Starship S33

Print on Cardstock (110 lbs)

Belly side bottom

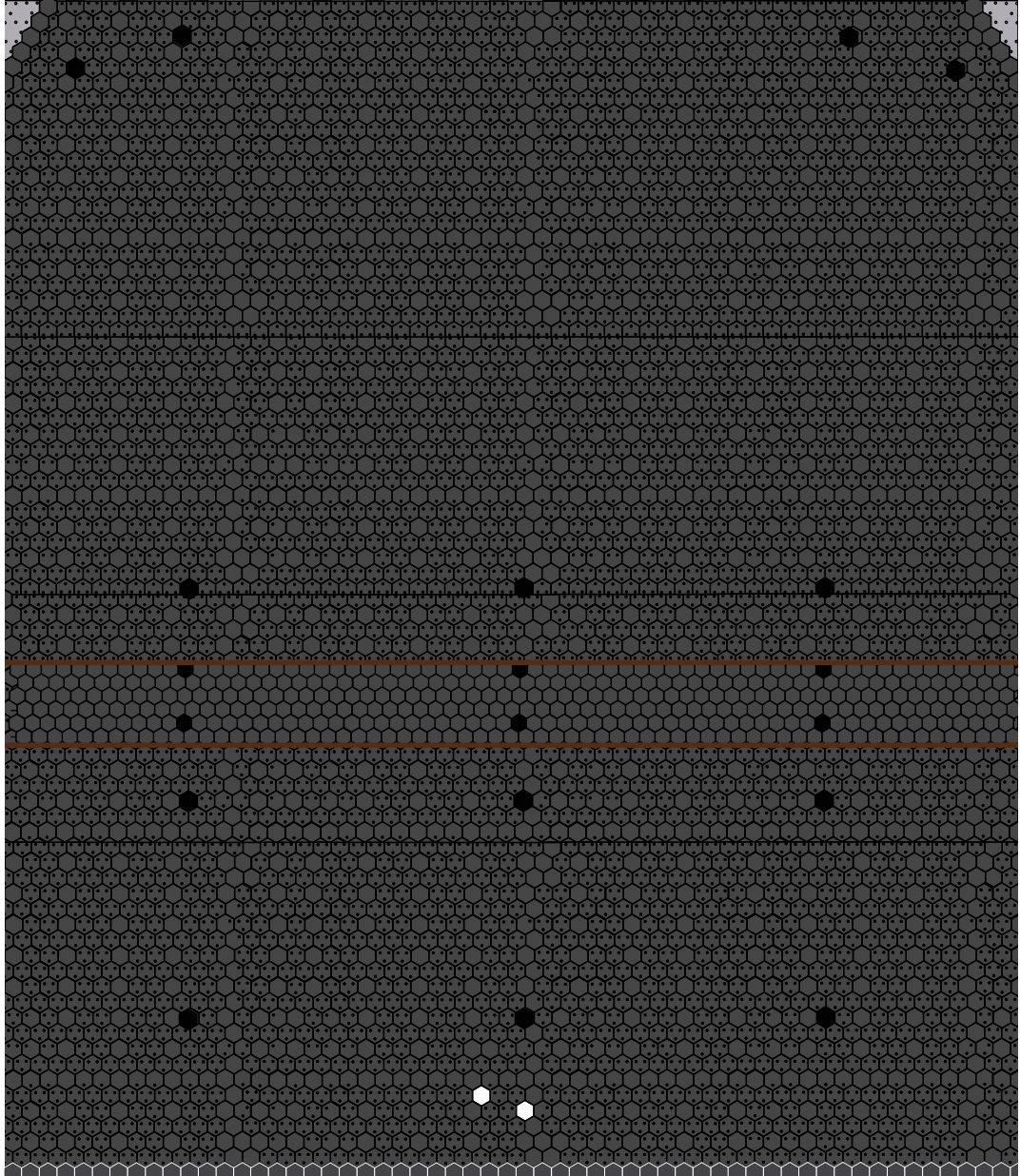
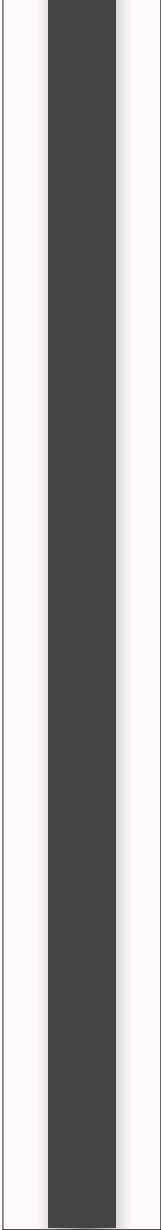



1:100 Scale

SpaceX Starship S33

Print on Cardstock (110 lbs)

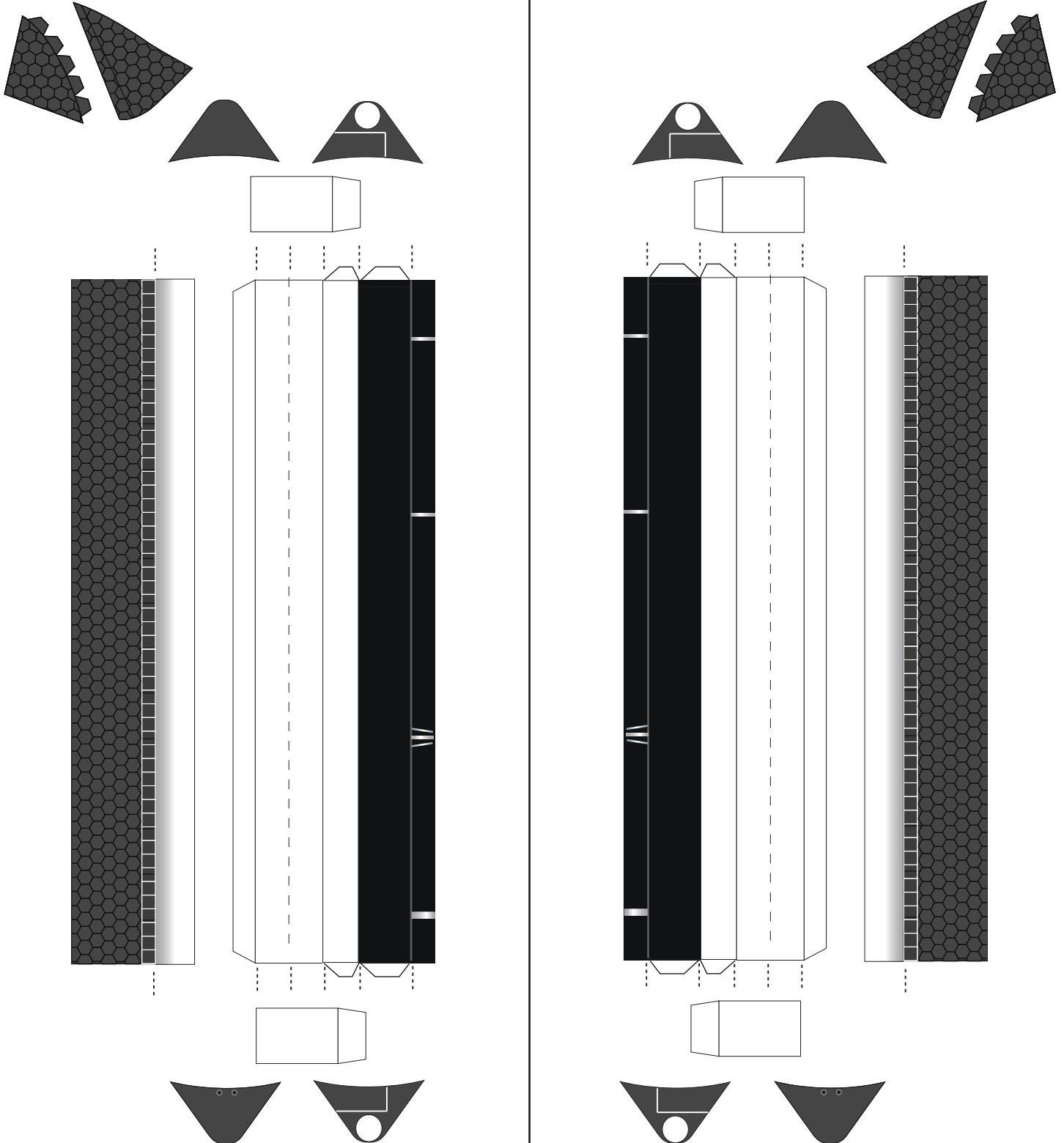
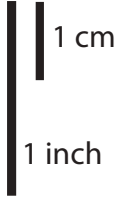



1:100 Scale



SpaceX Starship S33

Print on Cardstock (110 lbs)

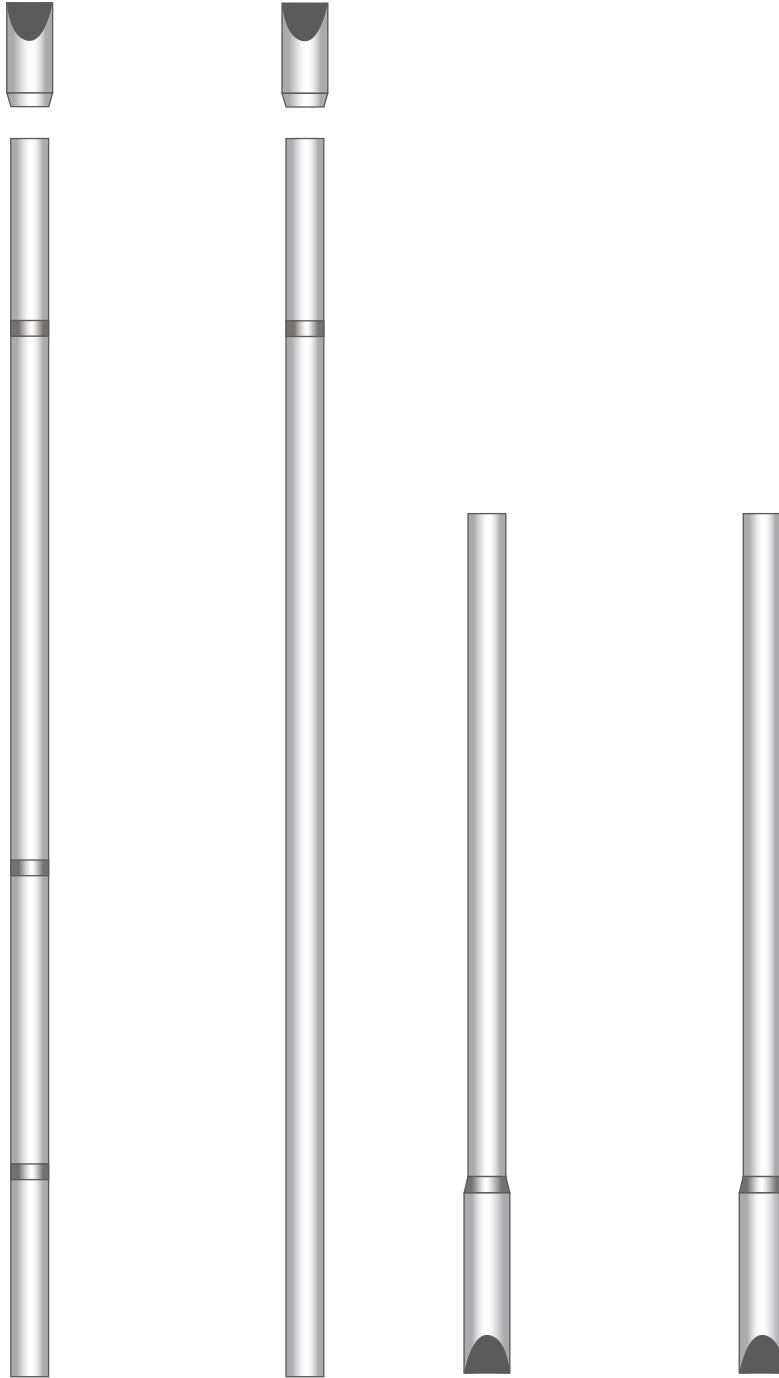



1 cm

1 inch

1:100 Scale

Starship S33 Upper Dome

Print on Cardstock (110 lbs)

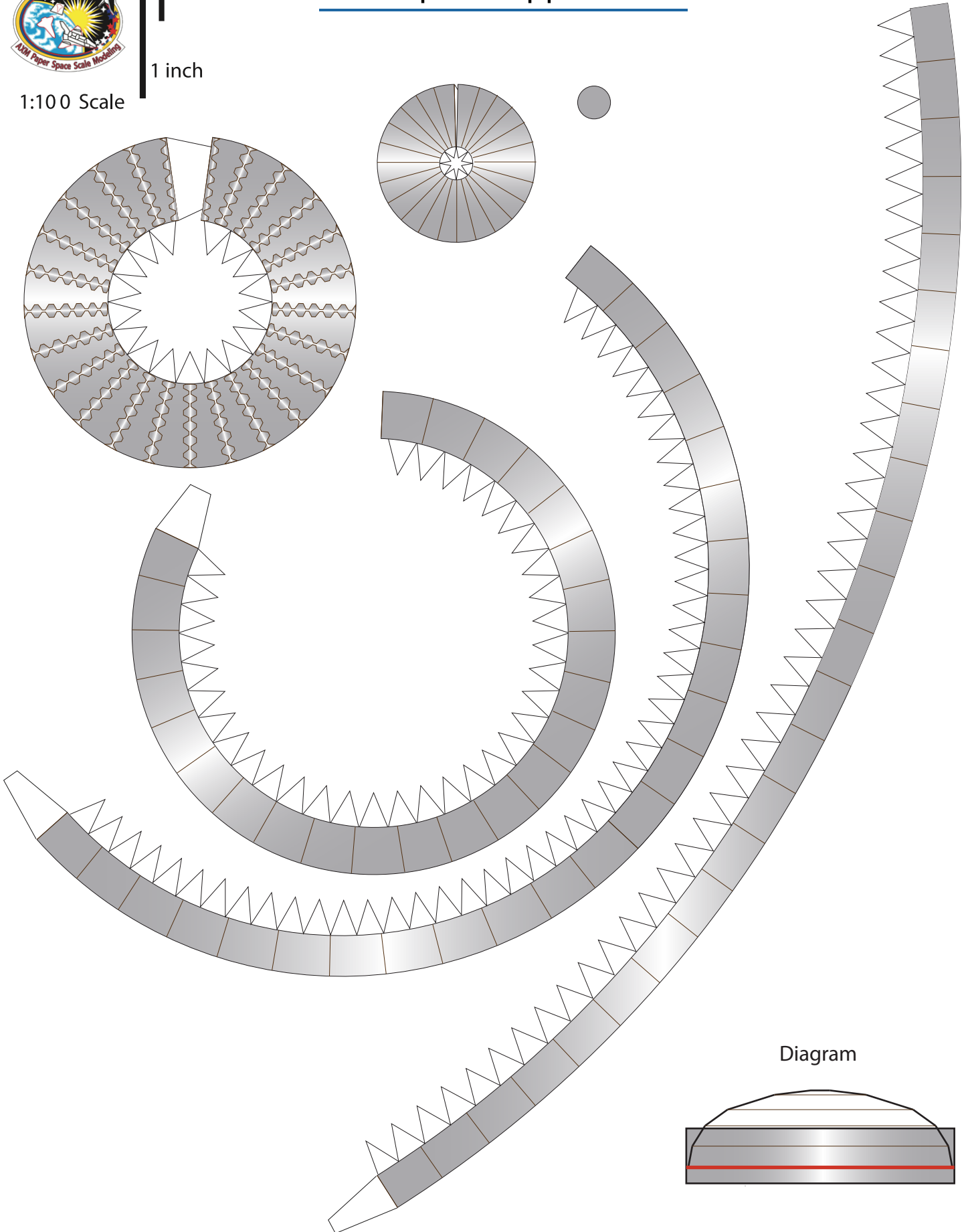



1:100 Scale

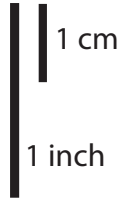

SpaceX Starship S33

Former for upper dome

Print on Cardstock (110 lbs)

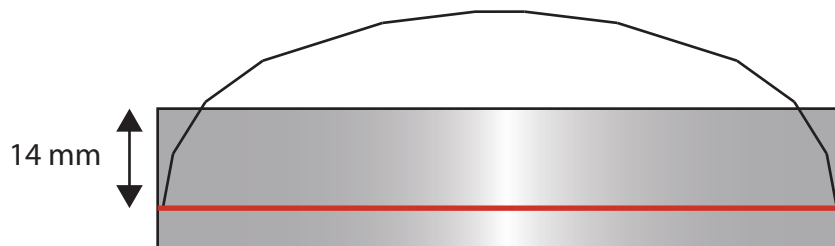
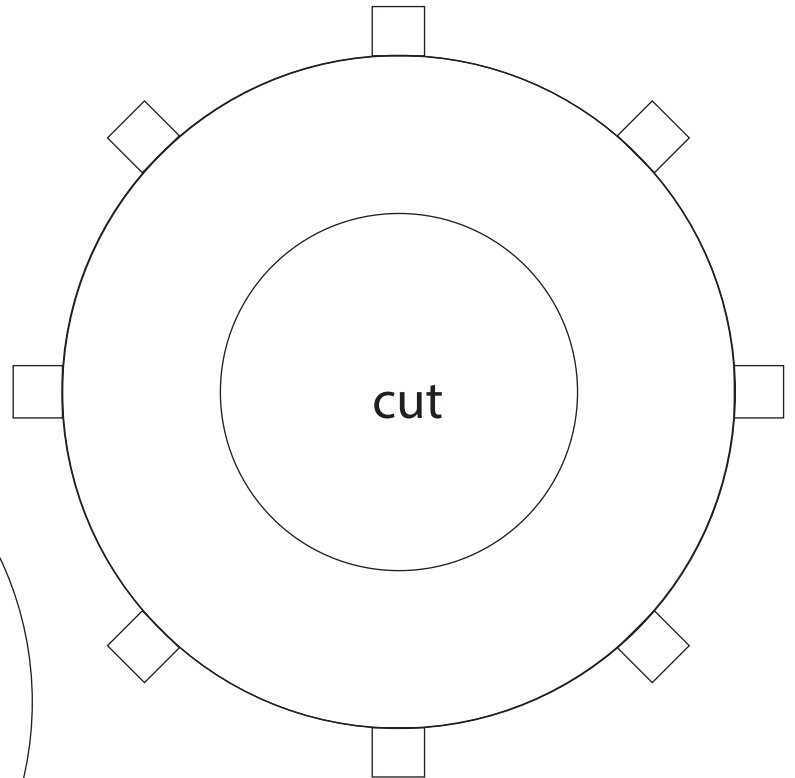
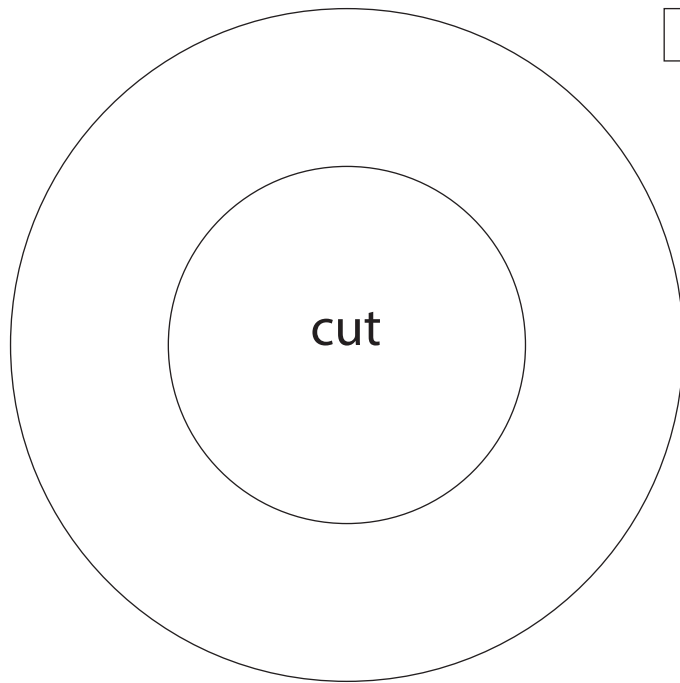

IMPORTANT
Top former is glued 14 mm from top edge of upper body for Starship S33 model



1 cm
1 inch

SpaceX Starship S33

Print on Cardstock (110 lbs)

1:100 Scale

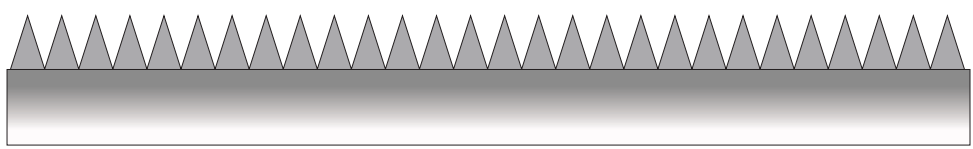

Nosecone connectors
(Use for a closed Ship
with no interior)

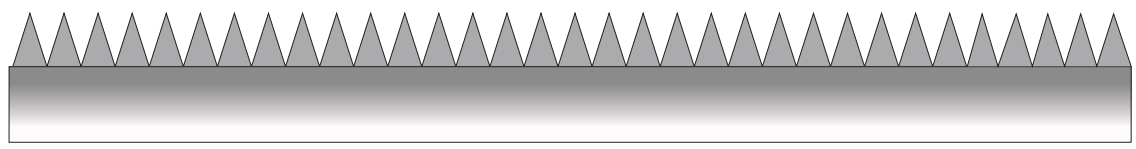

Connectors for upper
and lower body



Upperdome
interior wall

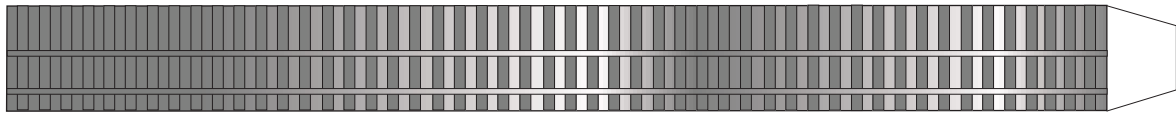
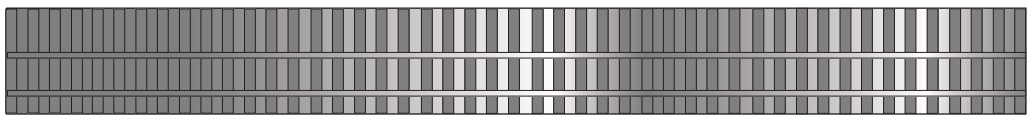

LOX dump pipes

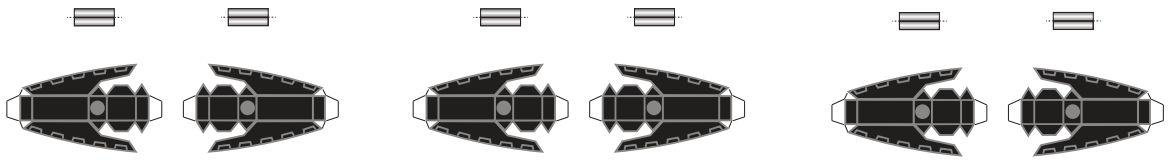
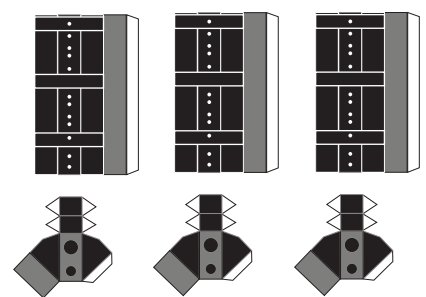

umbilical
side

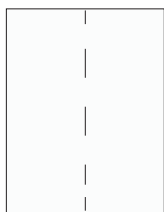
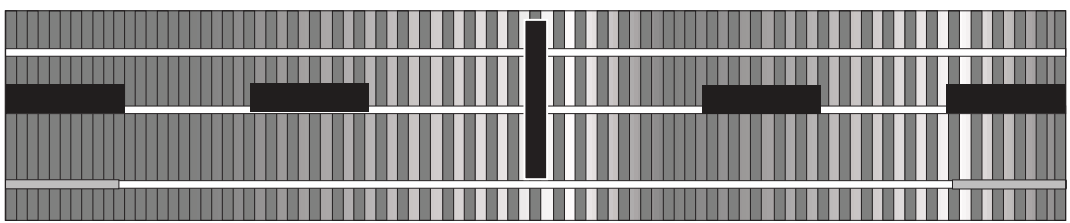

LOX dump pipe locations

tile side

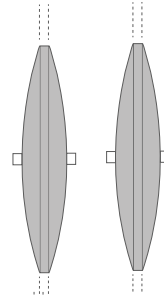
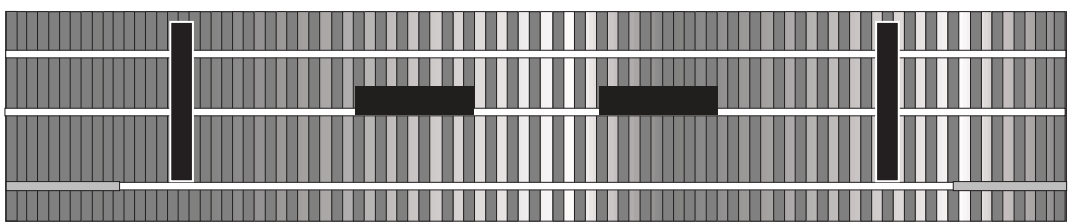



1:100 Scale

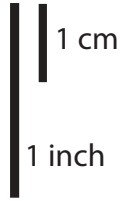

SpaceX Starship

Print on Cardstock (110 lbs)

Formers for lower body

Top

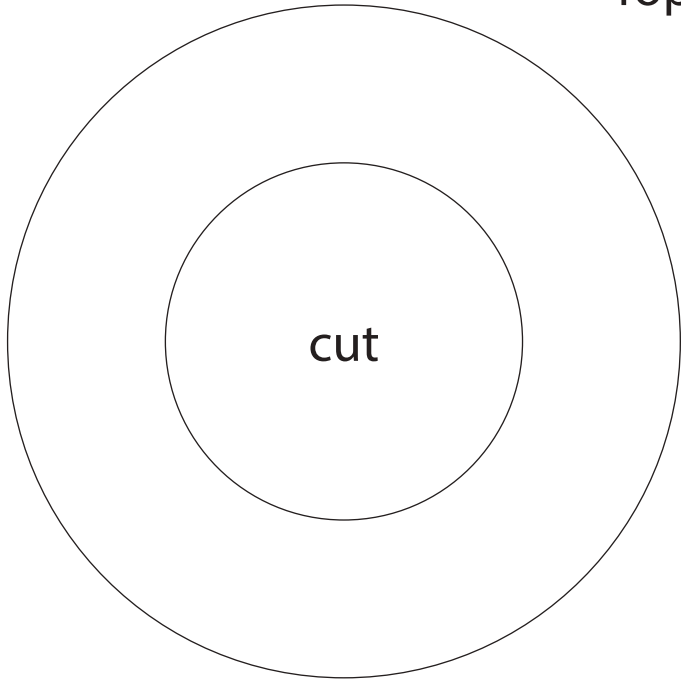
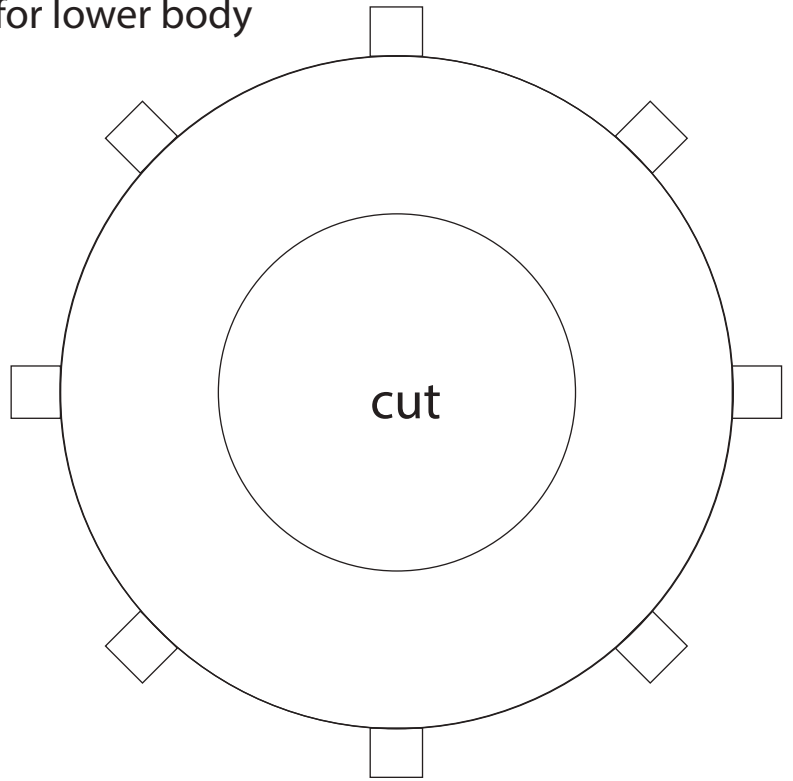

Bottom

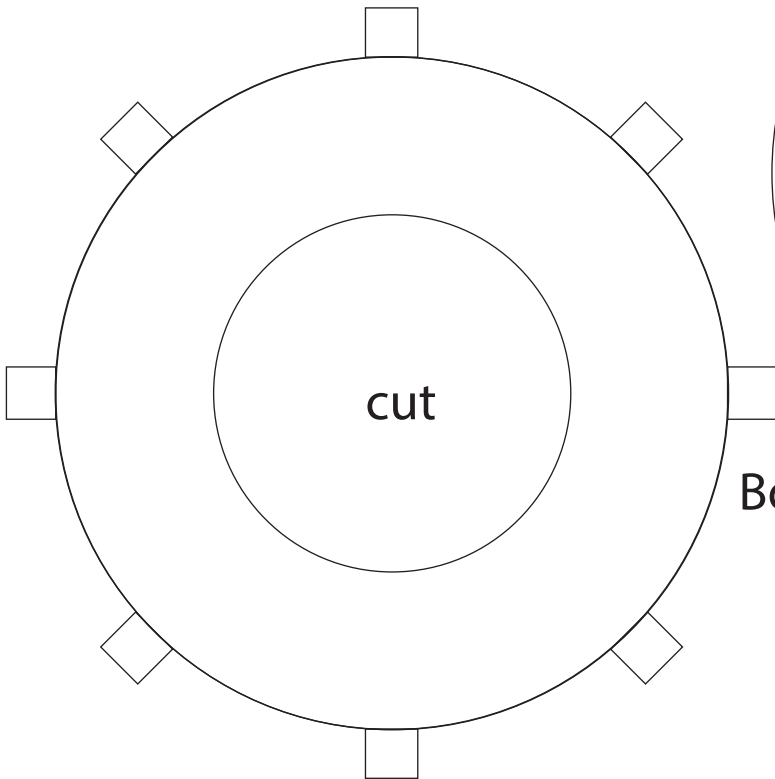
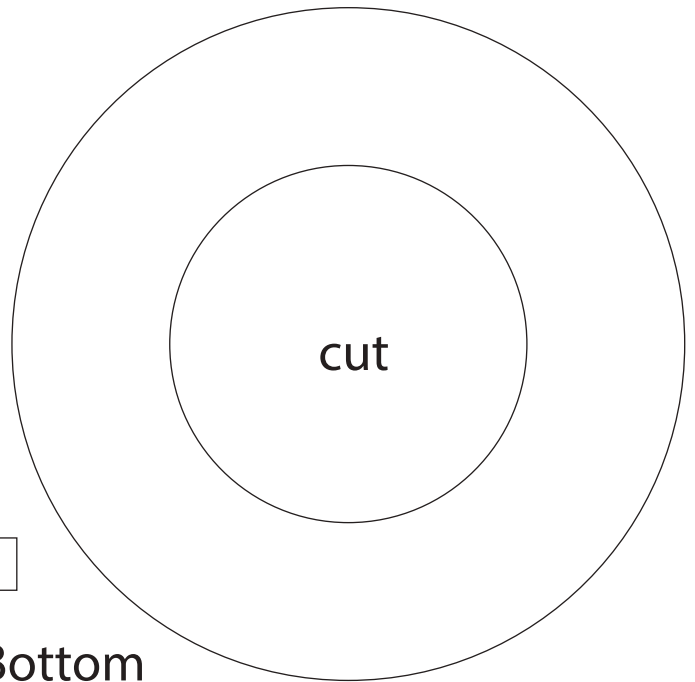

IMPORTANT

Top former is glued 20 mm from bottom edge of upper body.
Bottom former is glued 27 mm from bottom edge of lower body.



1 cm

1 inch

1:100 Scale

SpaceX Starship S33

Print on Cardstock (110 lbs)

Engine floor

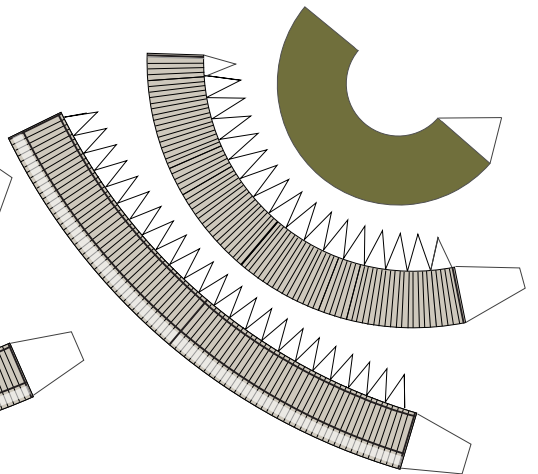
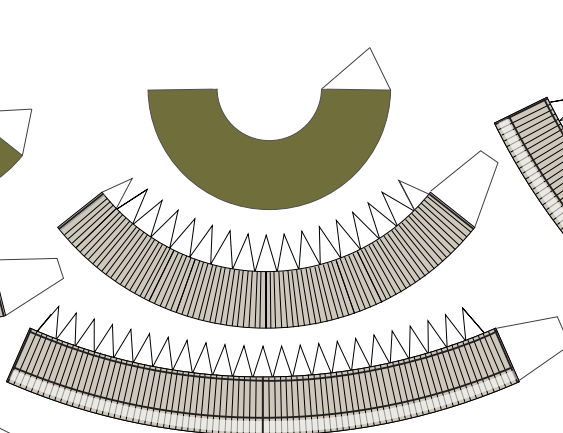
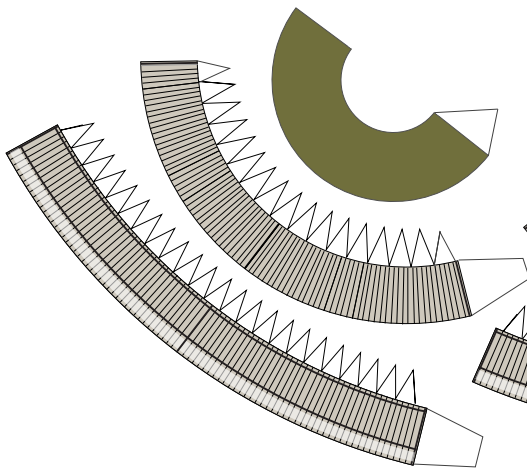
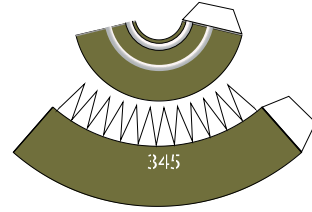
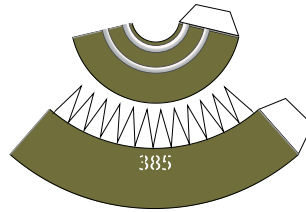
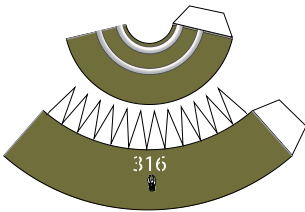
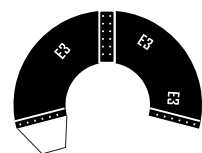
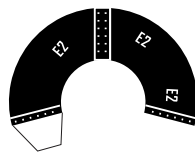
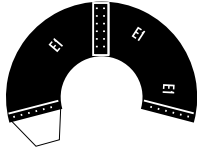
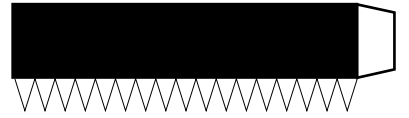
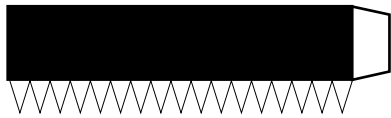
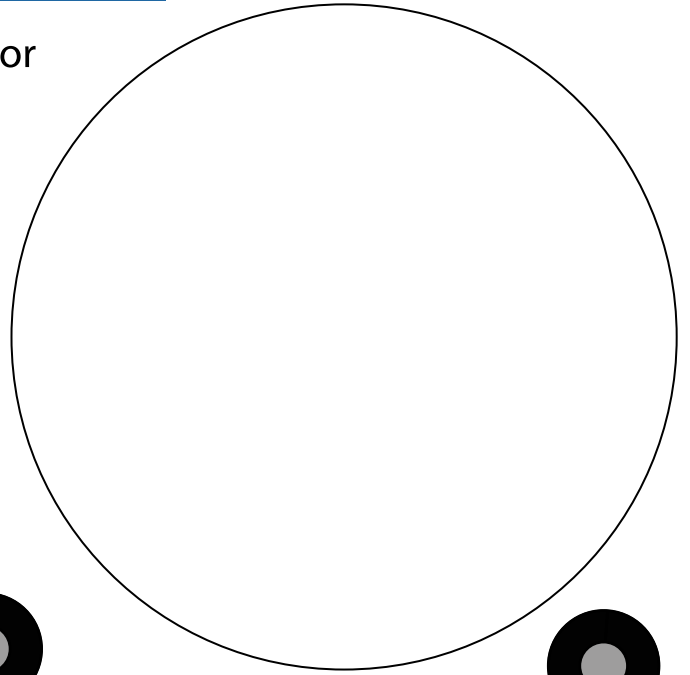
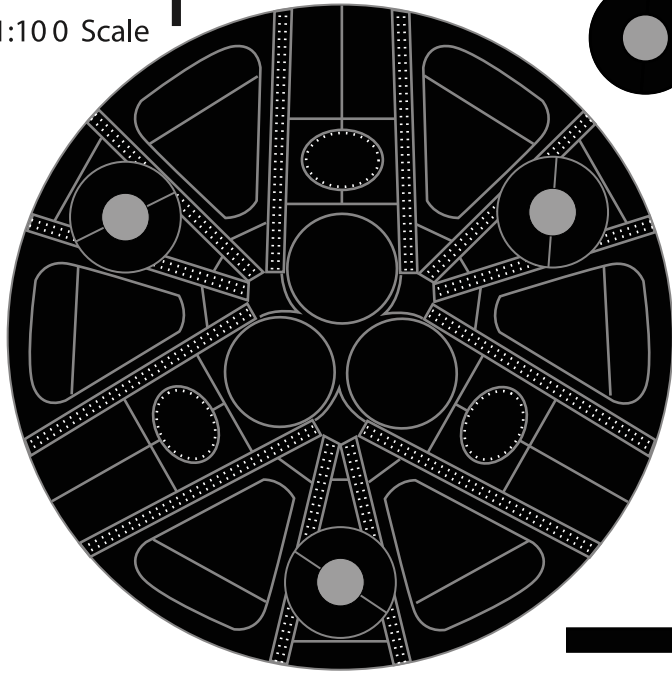

Raptor engine floor designed by @ChameleonCir



1:100 Scale



SpaceX Starship S33

Print on Cardstock (110 lbs)

Engine floor back print





1:100 Scale

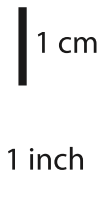

SpaceX Starship S33

Print on Cardstock (110 lbs)

Position of bottom former for Raptor engine floor

Raptor engines and floor paper version

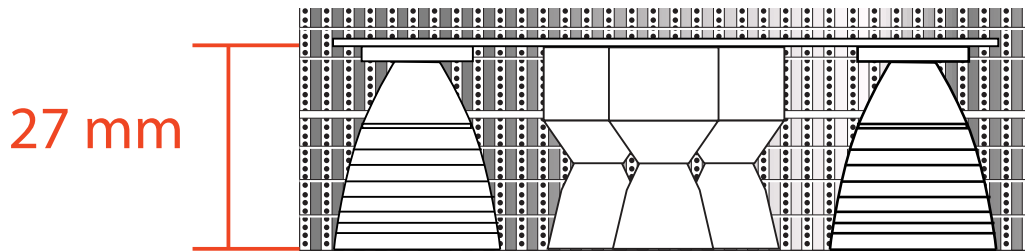

Raptor engines and floor 3D printable version

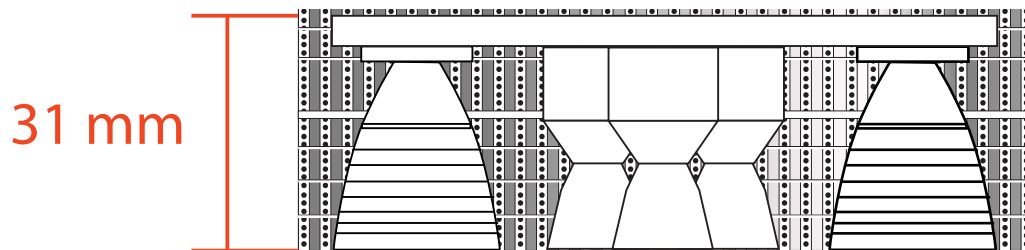



1 cm

1 inch

1:100 Scale

SpaceX Starship S33

Print on Cardstock (110 lbs)

Raptor Vacuum engine supports Diagram

Umbilical side

LOX dump
pipe

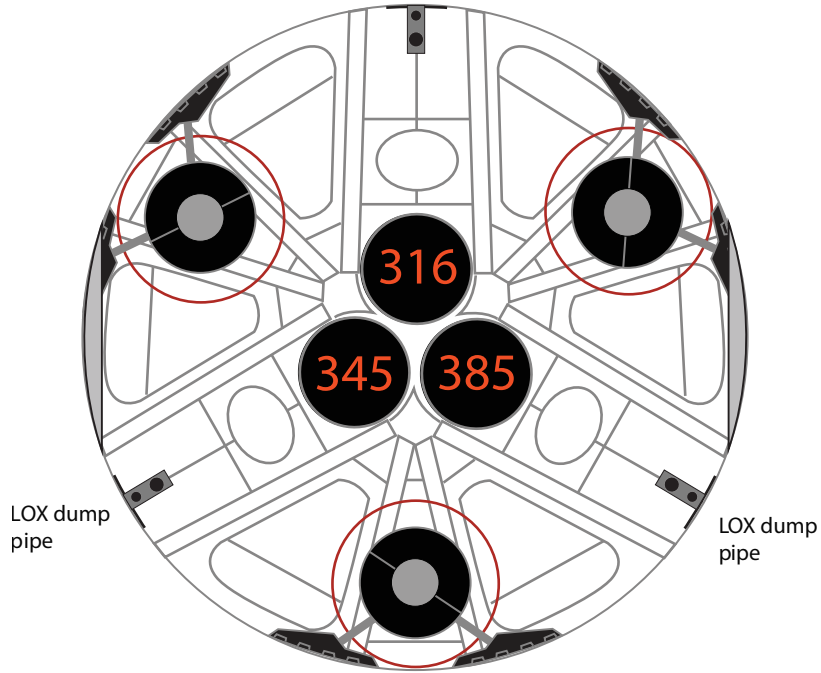

Tile side

Raptor engine numbers based on photos

Raptor engine floor designed by @ChameleonCir



1:100 Scale



SpaceX Starship S33

Print on Cardstock (110 lbs)

Engine wall for 3d printed parts

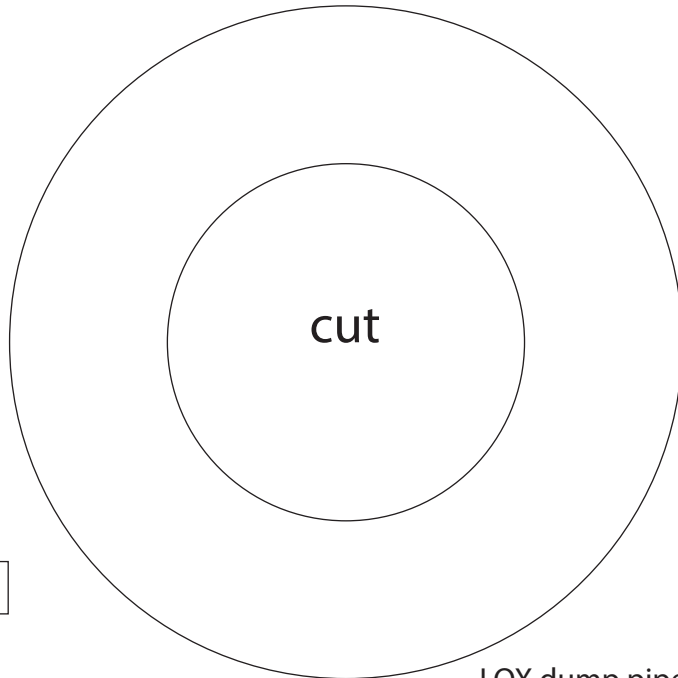
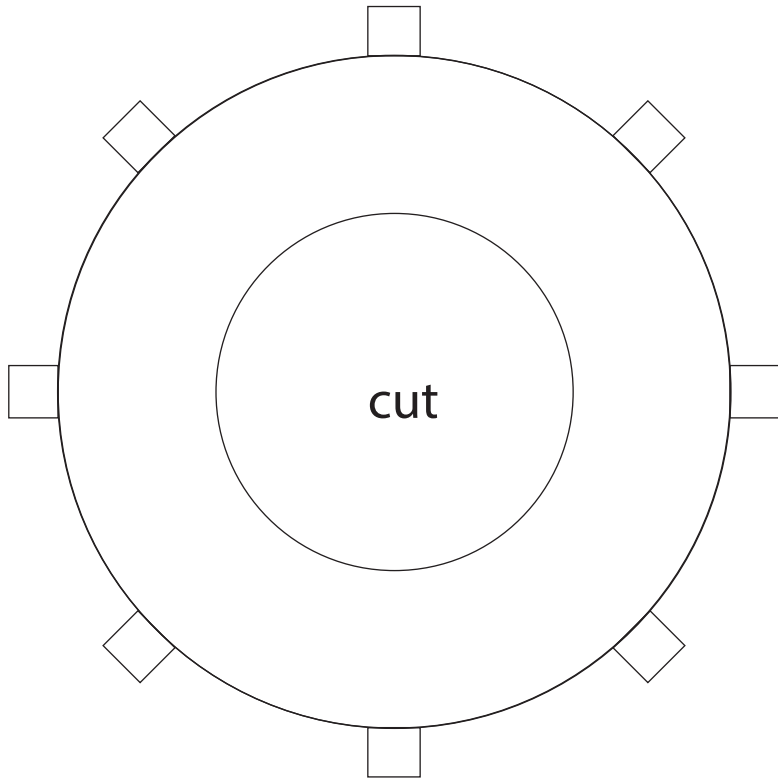

LOX dump pipes

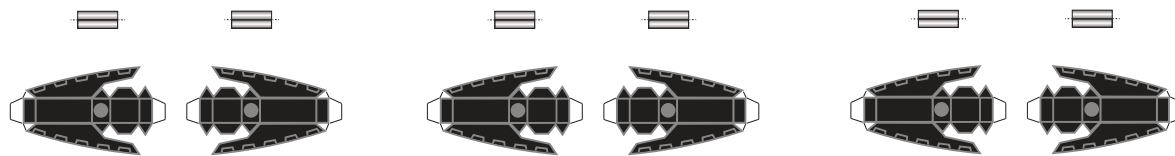
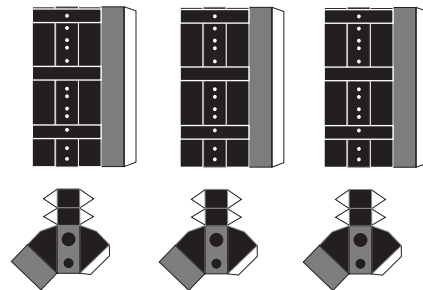

umbilical side

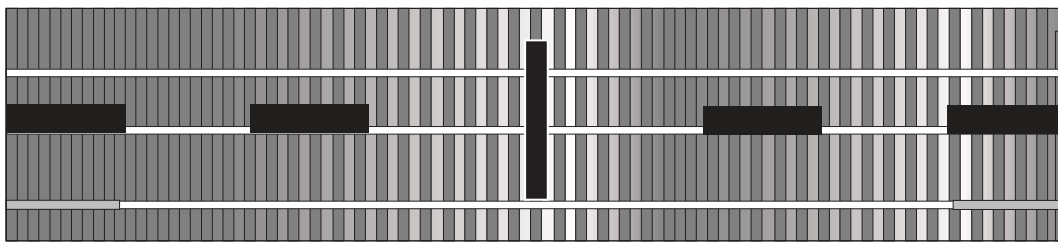

LOX dump pipe locations

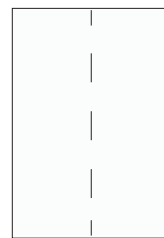

tile side

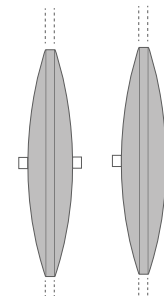
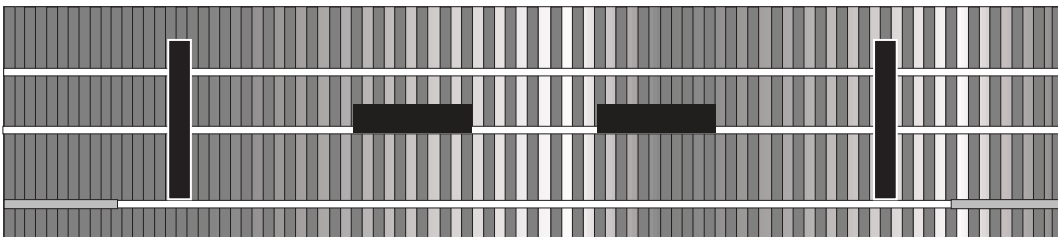

Starship block 2

2025
S33

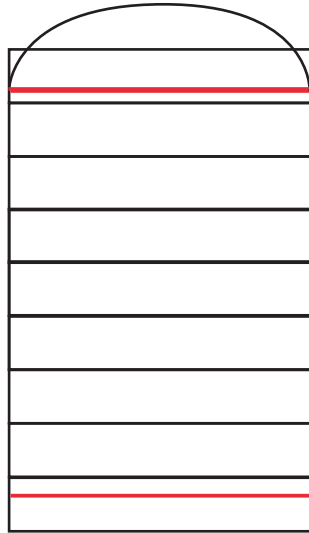
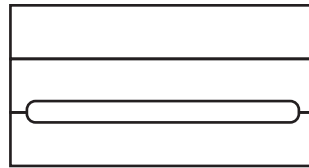
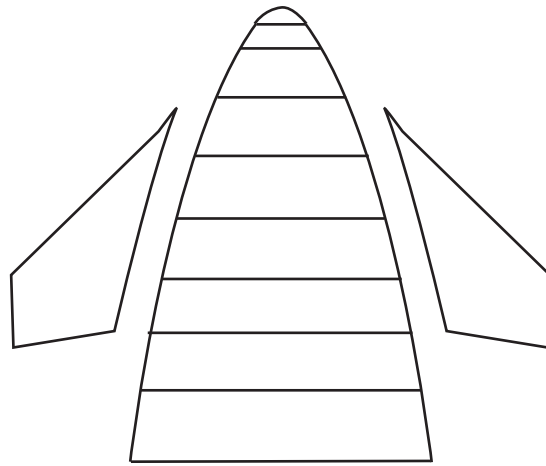

Optional Upperdome to be used
with nosecone interior.
Upperdome is glued on top of former.

