



1 cm  
1 inch

# Space Launch System (SLS)

Print on Cardstock (110 lbs)

## ARTEMIS Launch Abort System

1:96 Scale

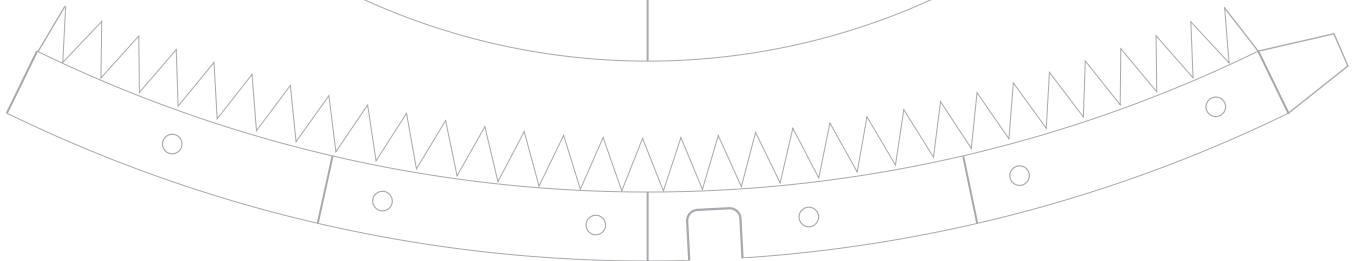
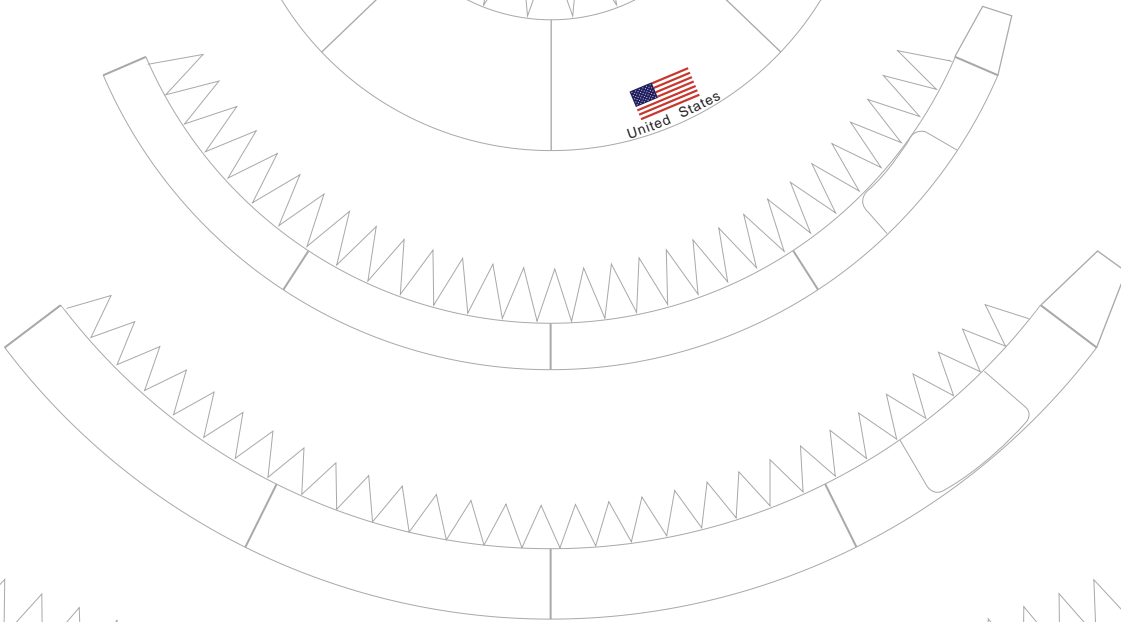
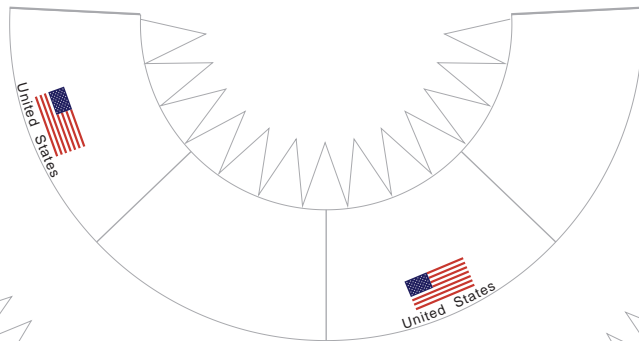
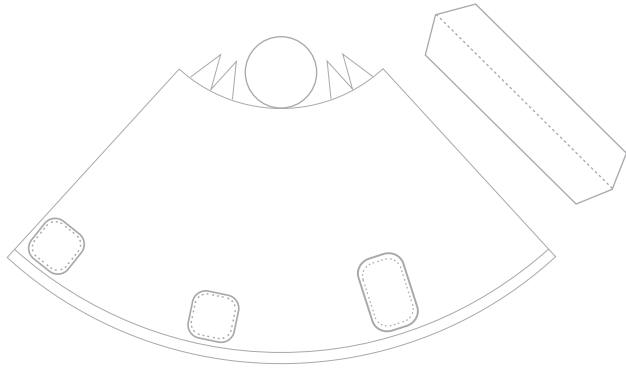
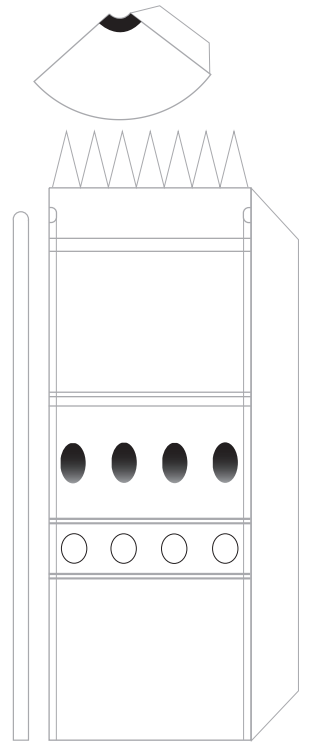
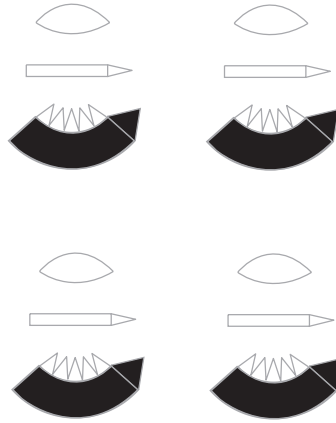



1 cm  
1 inch

# ORION Artemis-1



Print on Cardstock (110 lbs)

Revised

A1

Glue A1

1:96 Scale

## ORION's heatshield

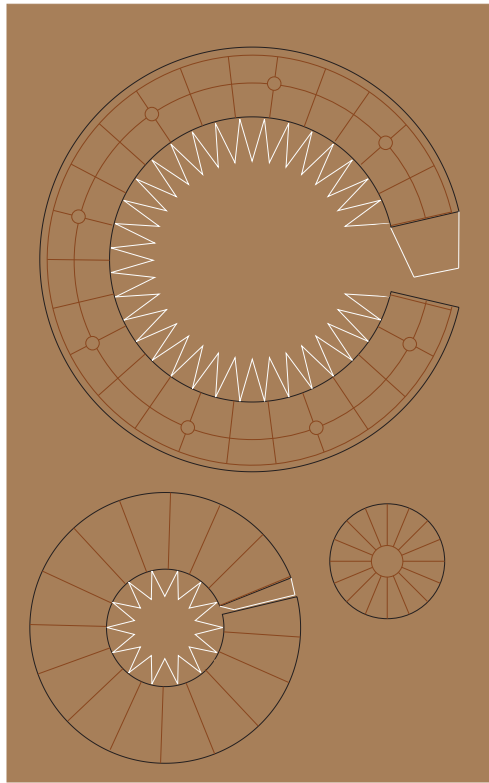

Orion's capsule adaptor

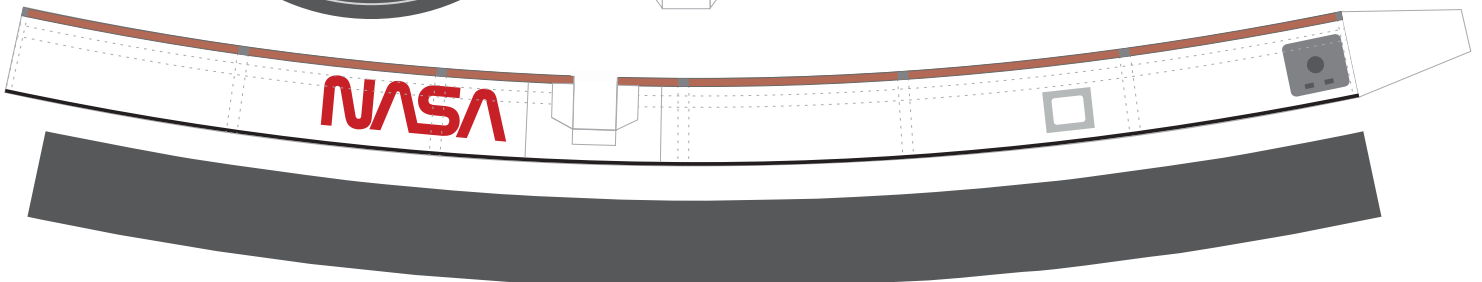
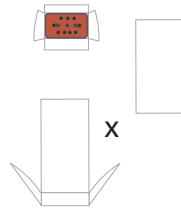
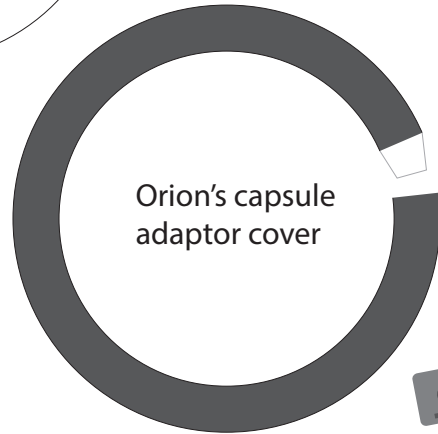
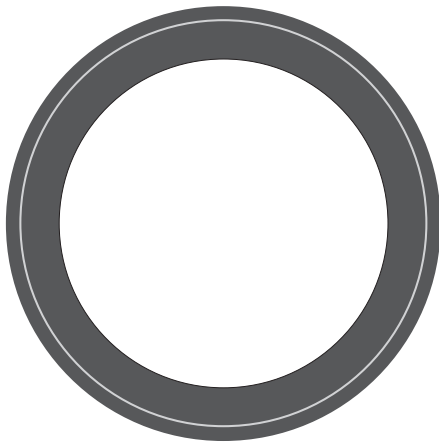
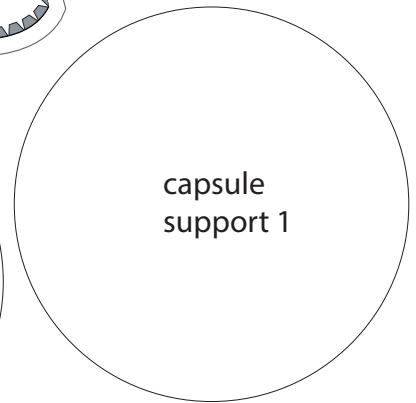
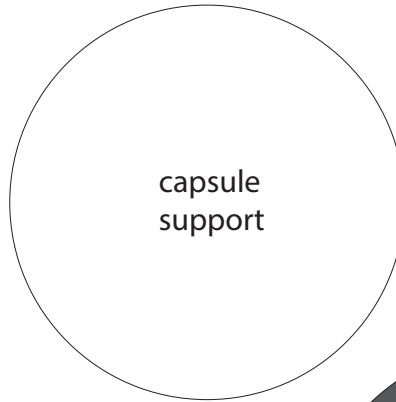
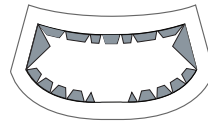
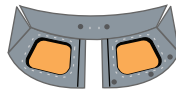
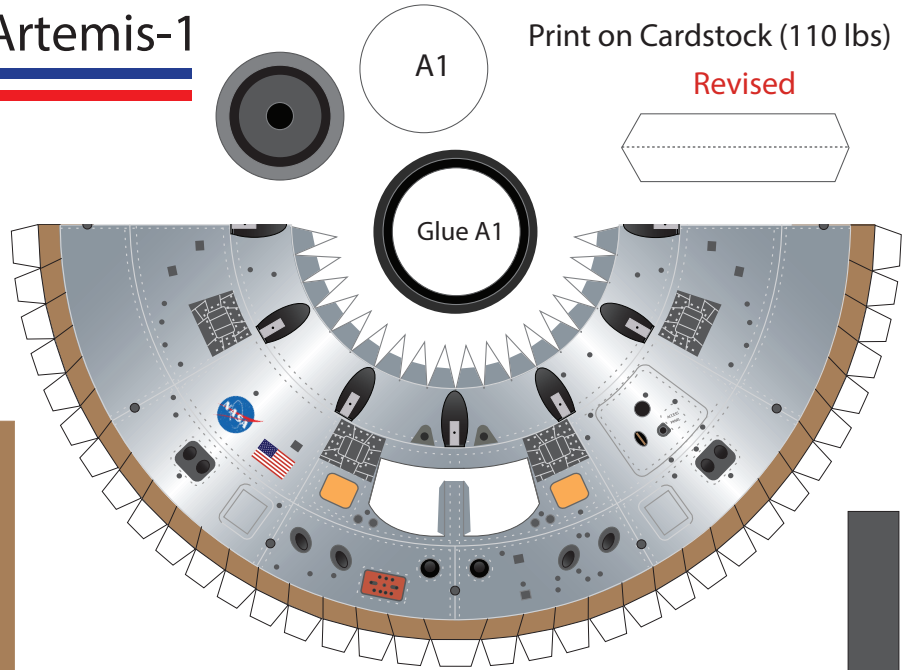



1 cm  
1 inch

# ORION Artemis-1

Print on Cardstock (110 lbs)

Revised

1:96 Scale

Top

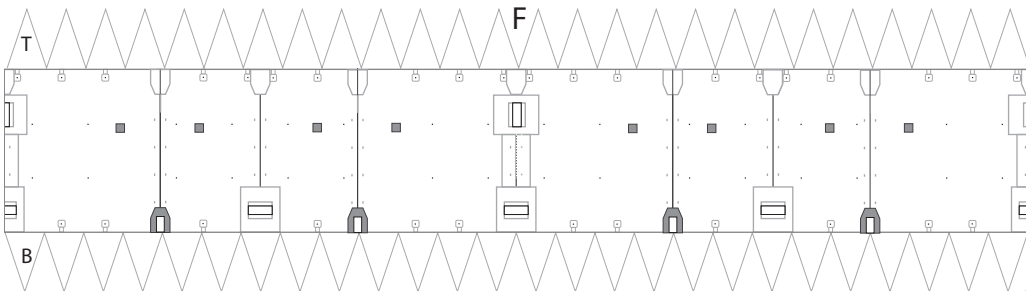
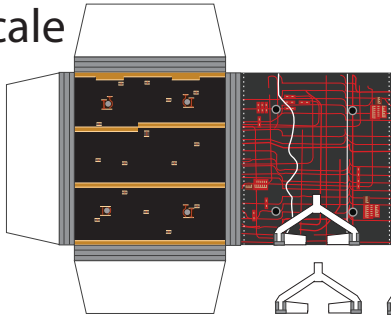
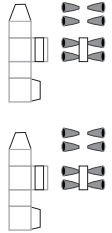
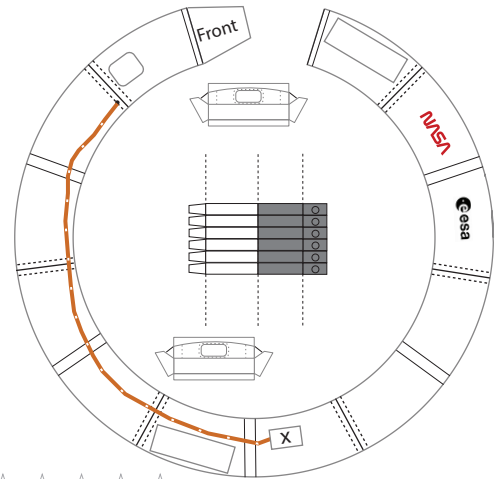
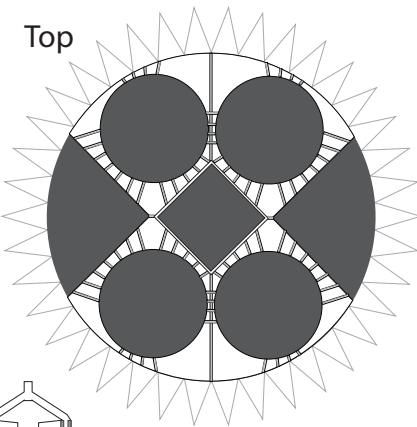

F

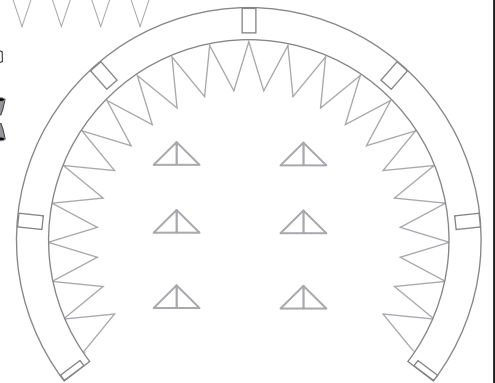
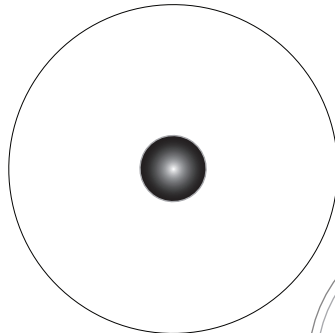
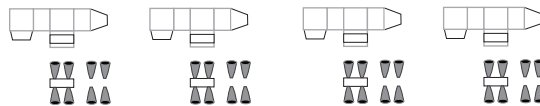
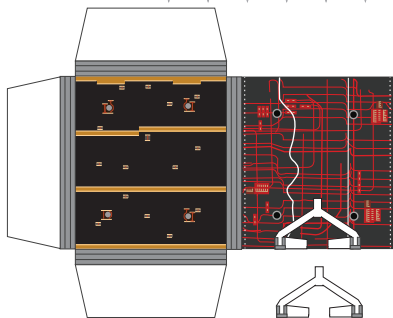
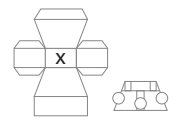

Front

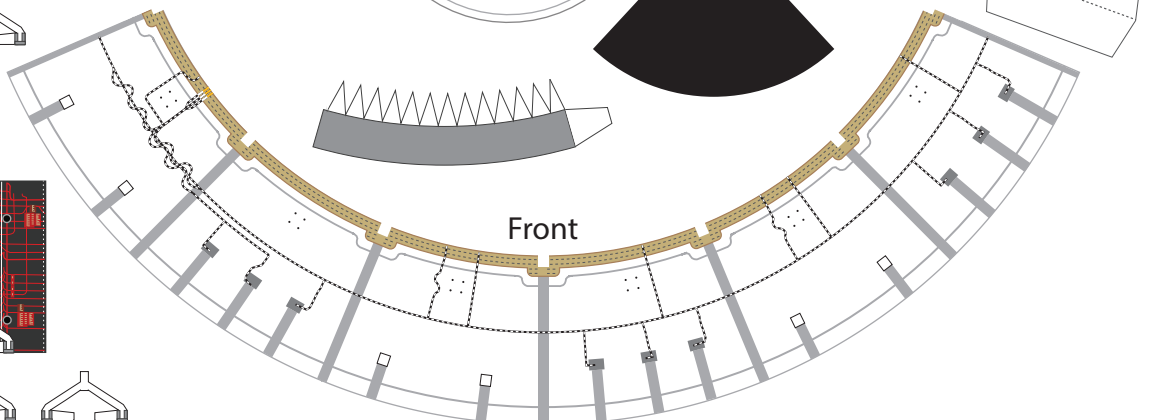
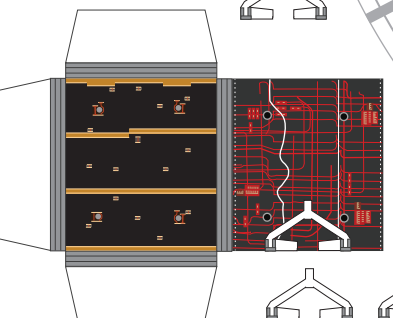
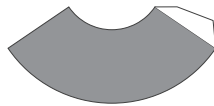
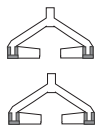
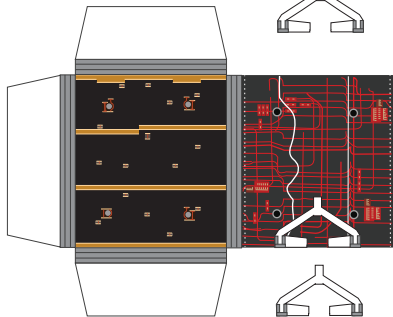
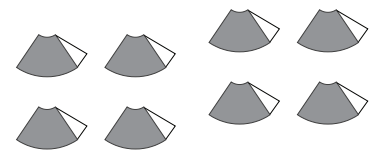
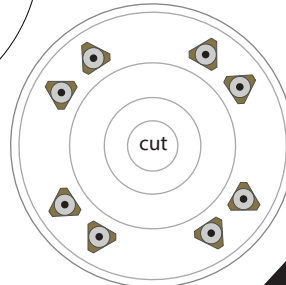

Front



# Back Print page

## Service Module nozzles

1:96 Scale





Space Launch System (SLS)

Print on Cardstock (90 lbs)

# ARTEMIS

Revised

## Deployed Solar Panels

1:96 Scale

Back

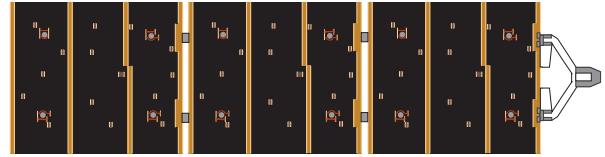
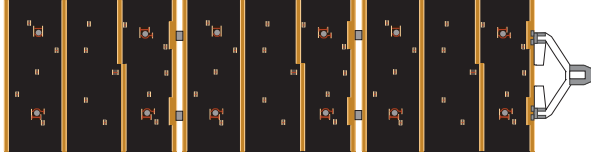

Front

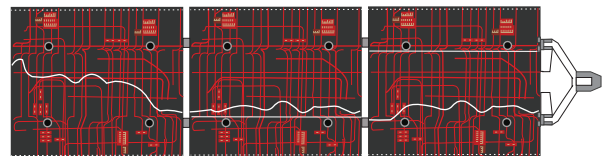
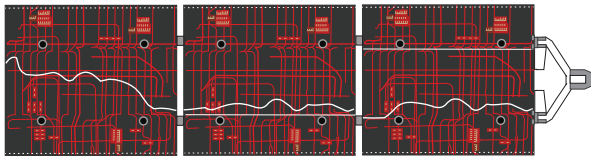
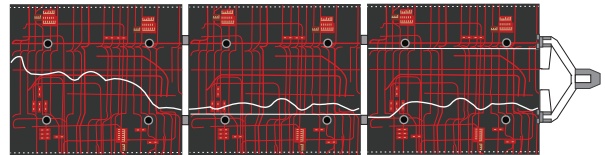
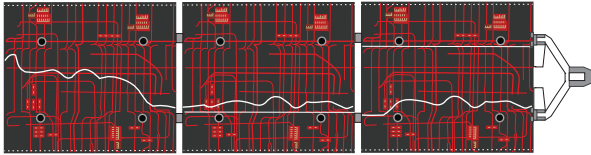

## Extended Solar Panel configuration

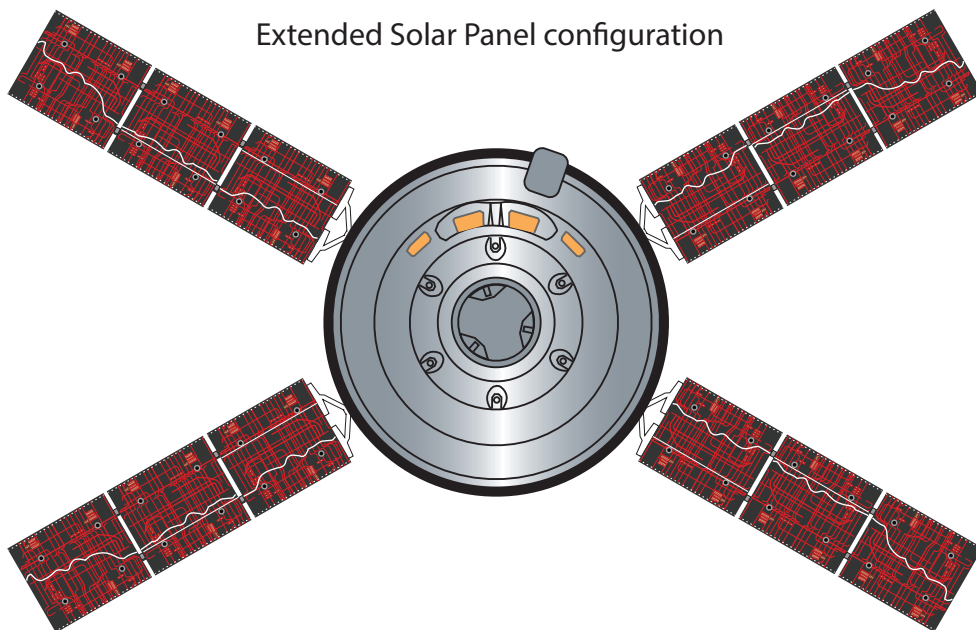



# Space Launch System (SLS)

Print on Cardstock (110 lbs)

## ARTEMIS

(Launch Configuration)



1:96 Scale

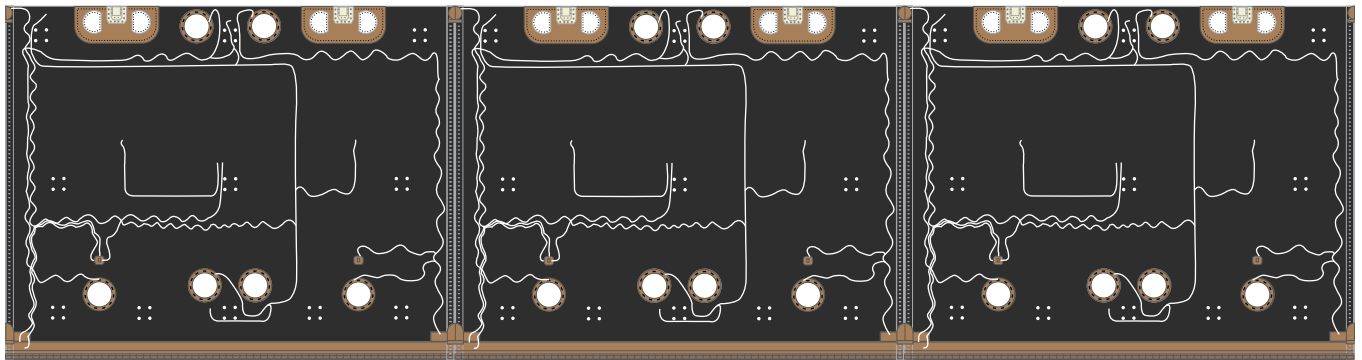
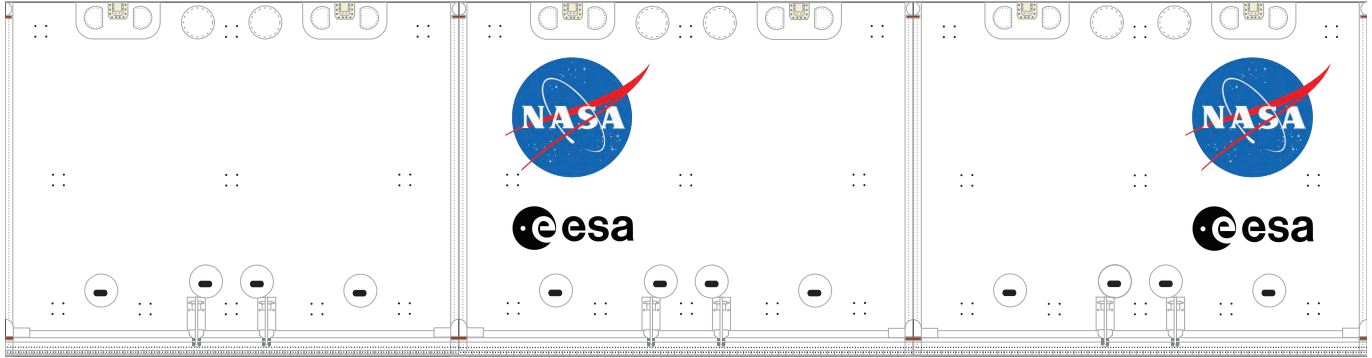

Connector between Service Module and Second Stage

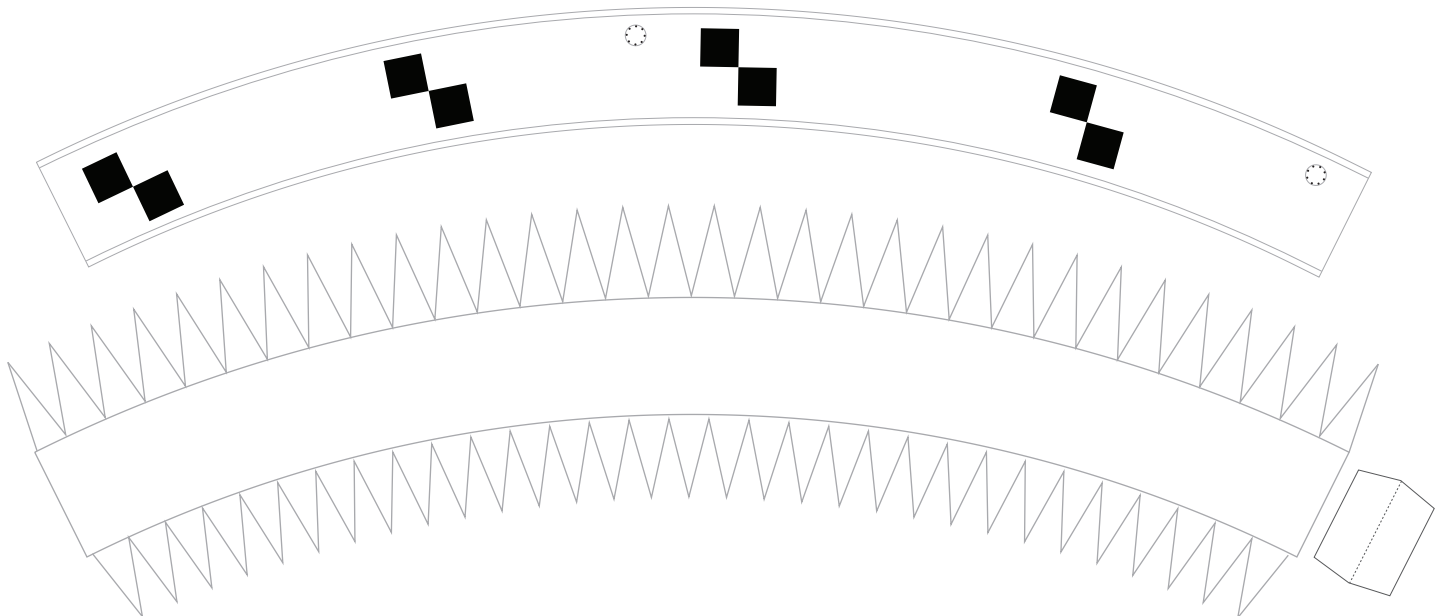



# Space Launch System (SLS)

Print on Cardstock (110 lbs)

## ARTEMIS

Service Module Fairing parts for Orbital configuration  
(Fairing separation)

1:96 Scale

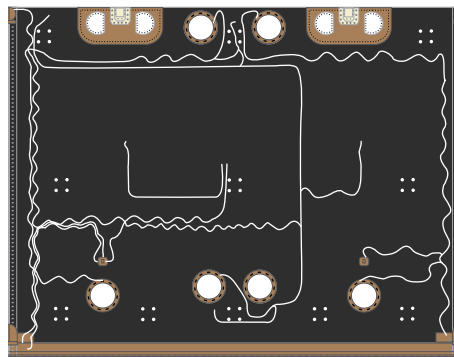
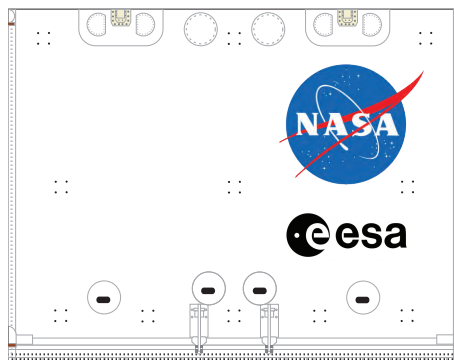
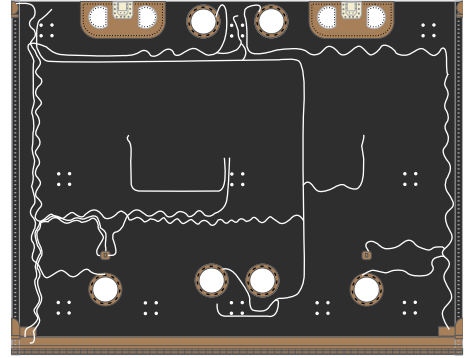
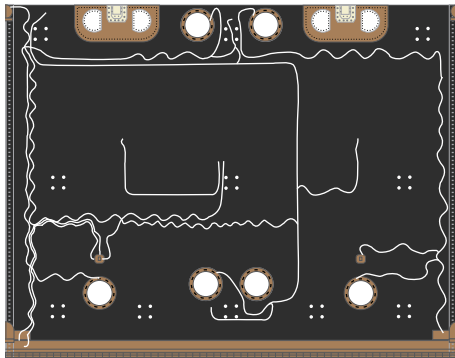
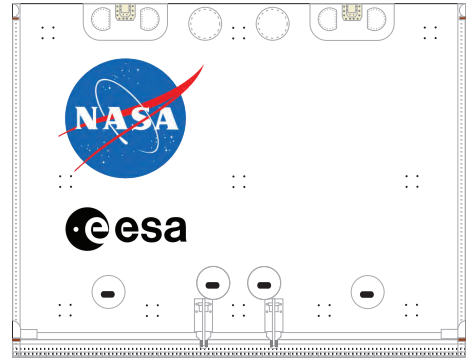
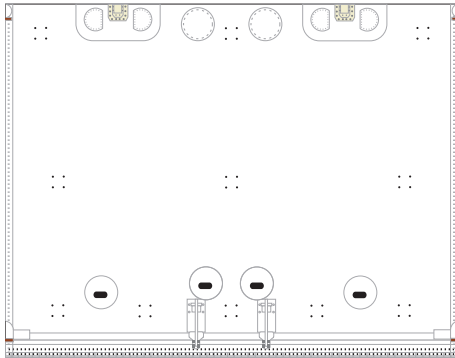



1 cm  
1 inch

# Space Launch System (SLS)

Print on Cardstock (110 lbs)

## ARTEMIS

1:96 Scale

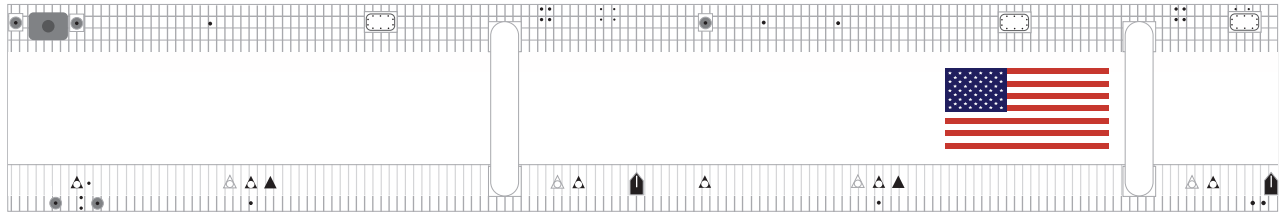

Fuel lines to upper dome

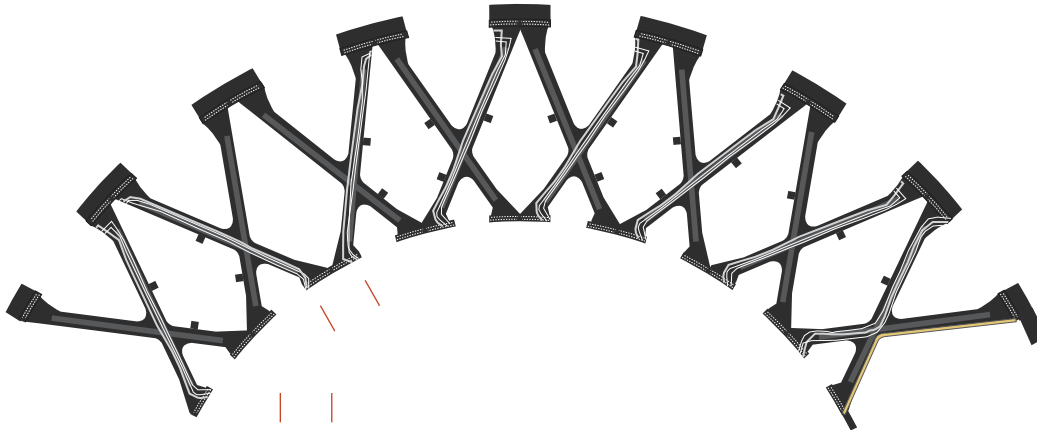

Fuel lines to lower dome

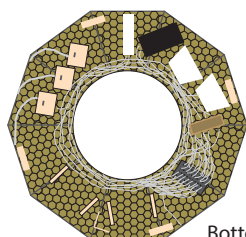
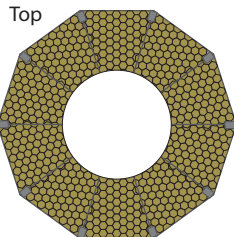
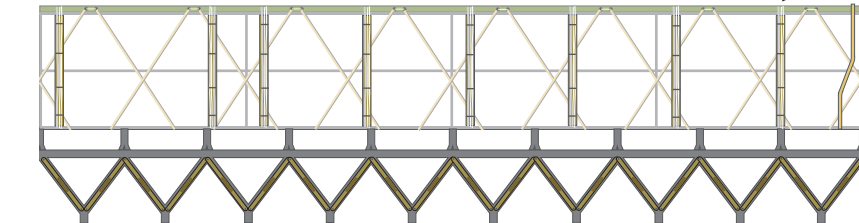
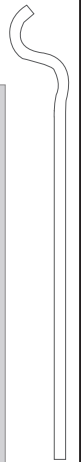

Bottom

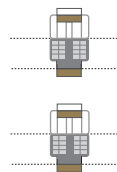
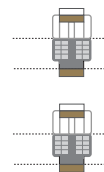
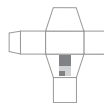
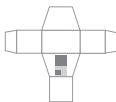
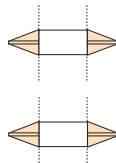
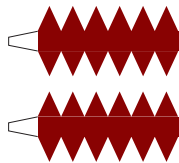

Tanks



Space Launch System (SLS)

Print on Cardstock (110 lbs)

# ARTEMIS

1:96 Scale

Backside print for Second Stage X Pattern framework





Space Launch System (SLS)

Print on Cardstock (110 lbs)

# ARTEMIS

## Second Stage LH2 tank dome

1:96 Scale

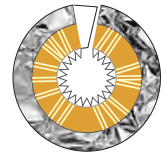
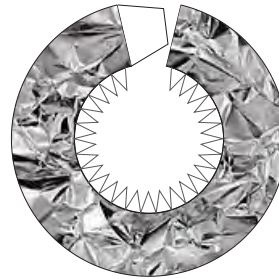
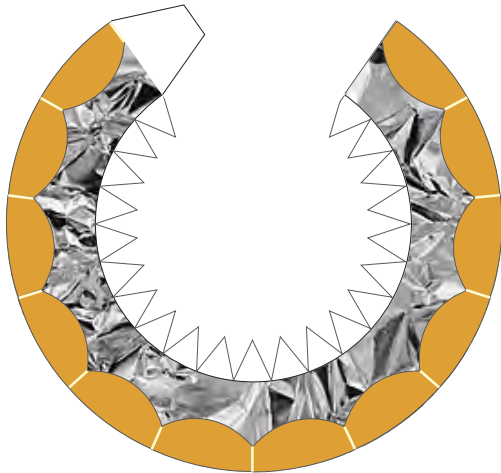
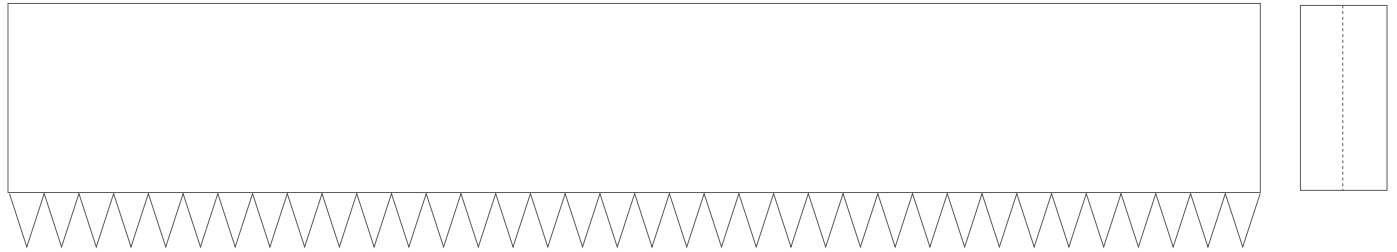

Diagram

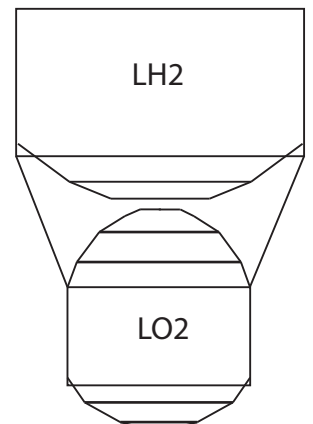



# Space Launch System (SLS) ARTEMIS

## Second Stage LO2 tank dome

Print on Cardstock (110 lbs)

1:96 Scale

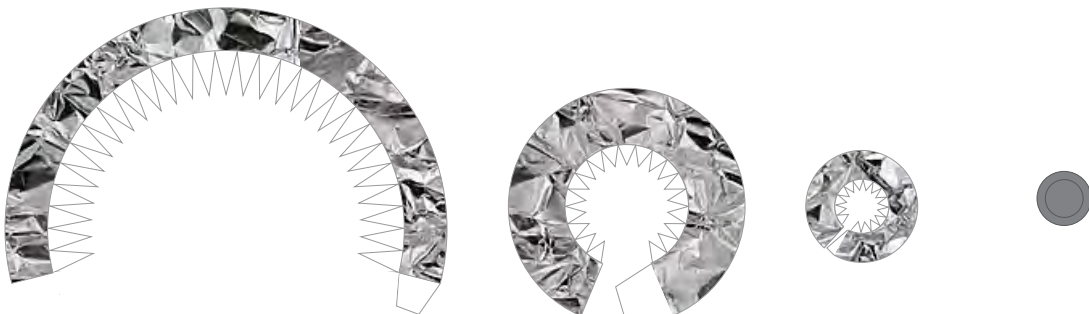
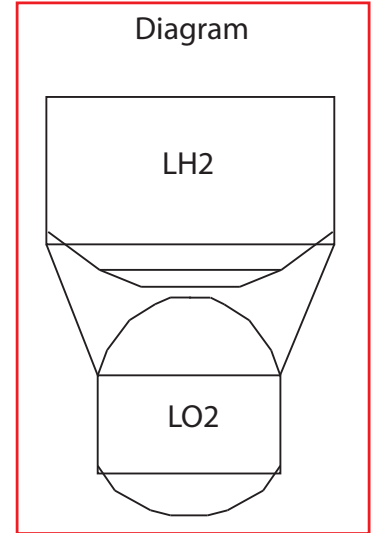
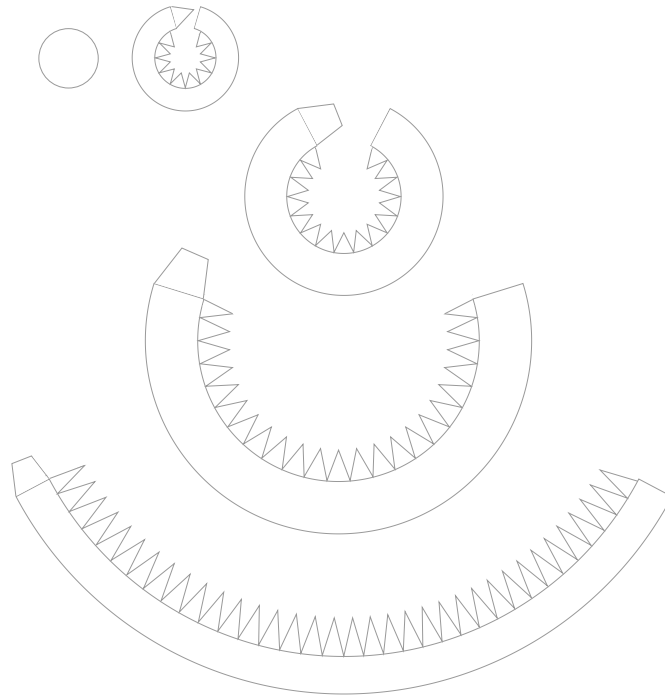



# ARTEMIS

1:96 Scale

Diagram

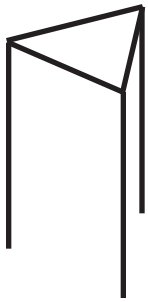

Exterior



Interior

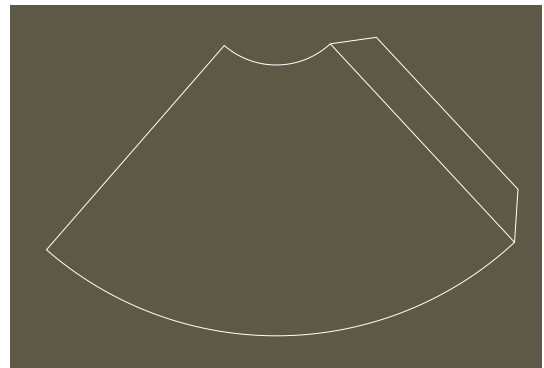
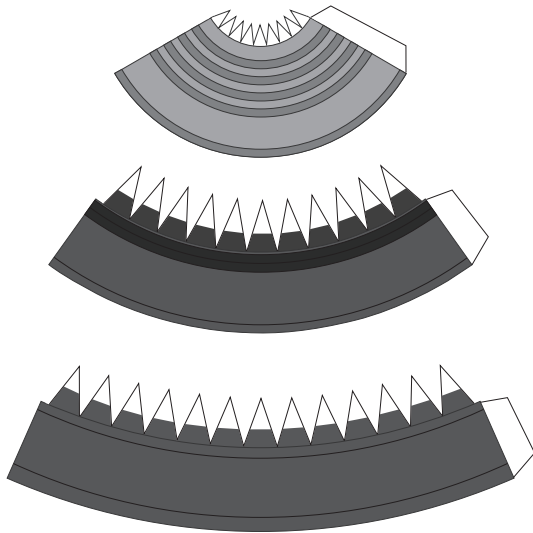
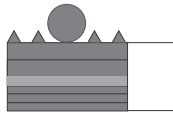

Pratt & Whitney RL10B-2 Engine