



1:100 Scale

Northrop Grumman "ANTARES" 230+ /Cygnus

Print on Cardstock (110 lbs)

New Payload Fairing for Extended Second Stage

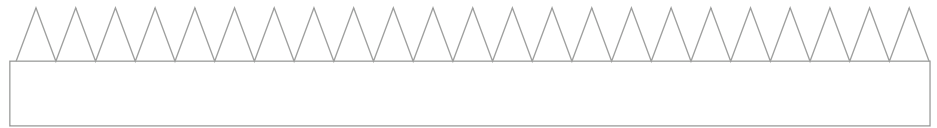
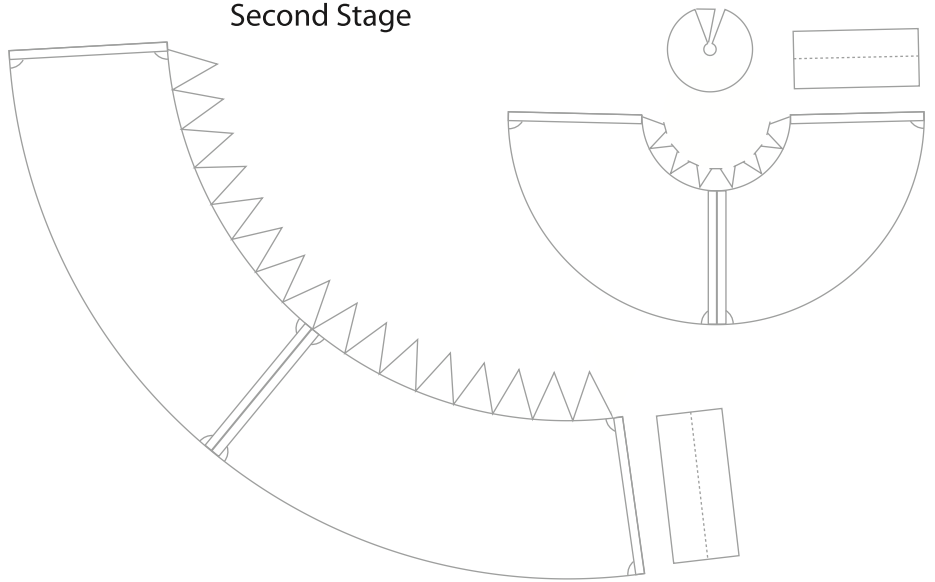
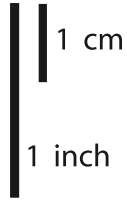

Payload Fairing / Stage 2

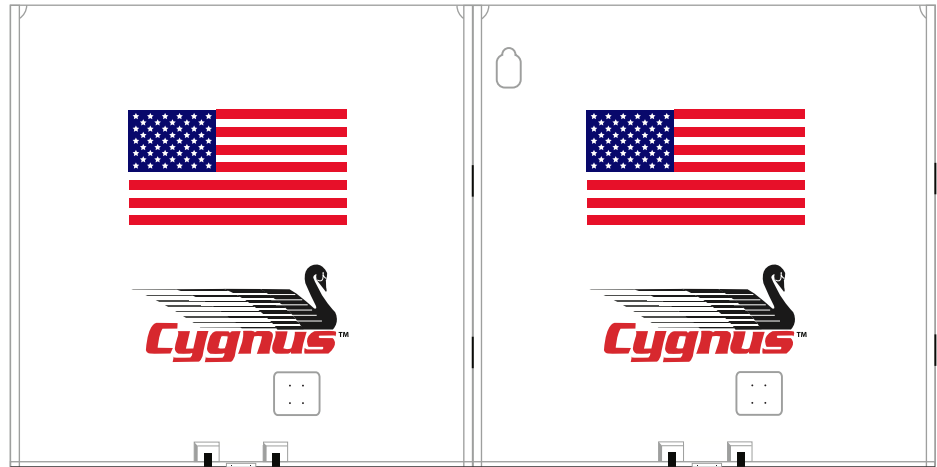
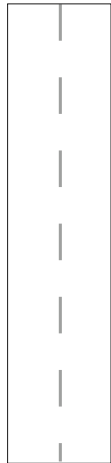

Optional



Payload Fairing / Extended Stage 2
connector
to Stage 1

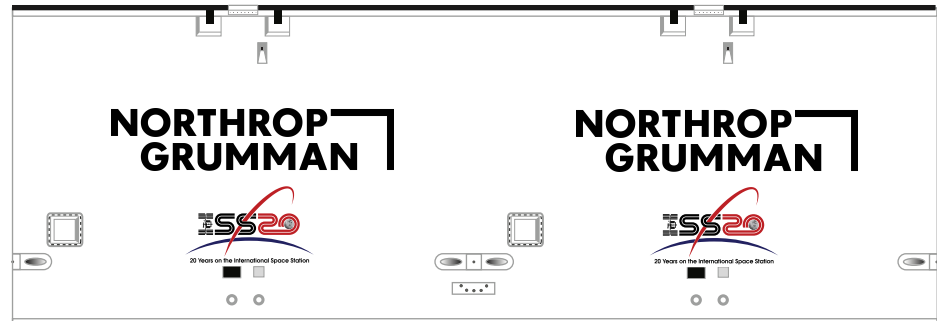
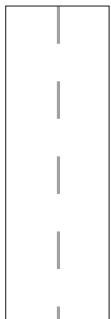



1:100 Scale

ANTARES New Stage 1

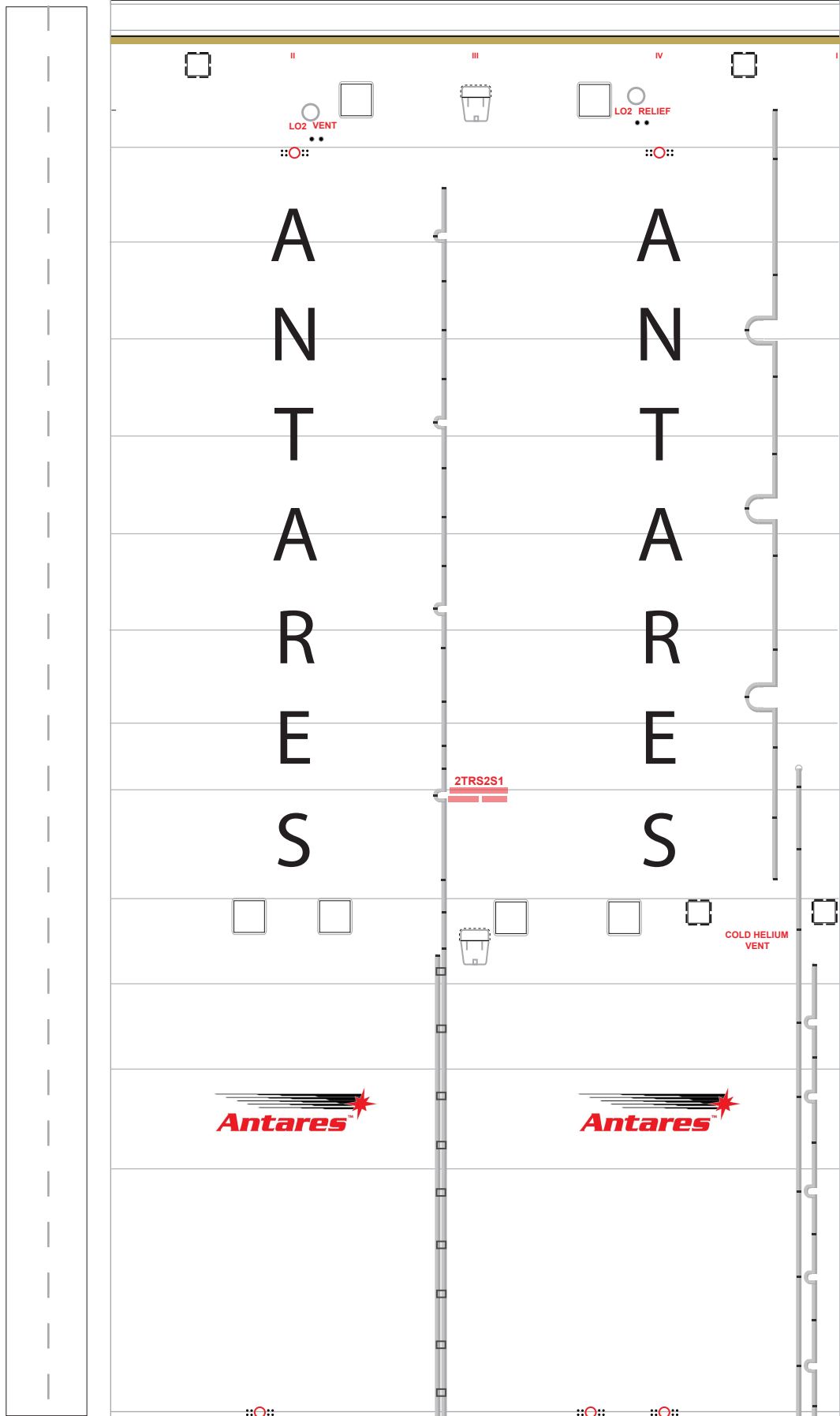



Engine section

1:100 Scale

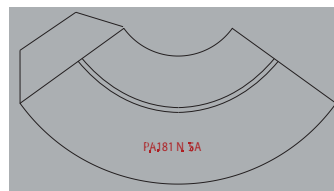
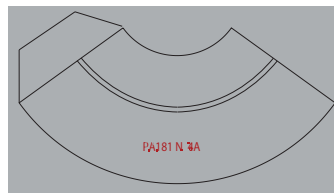
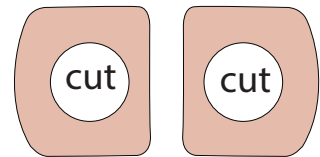
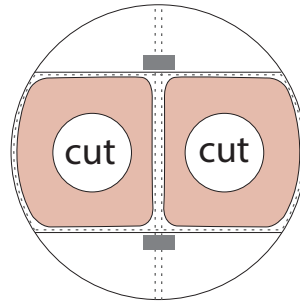
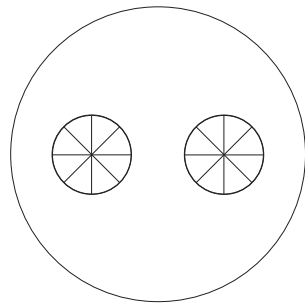
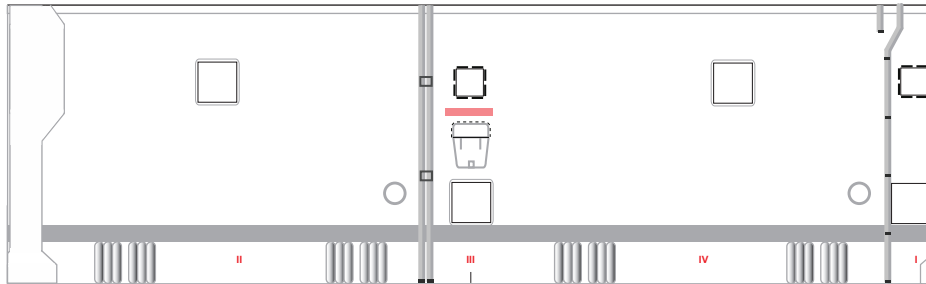
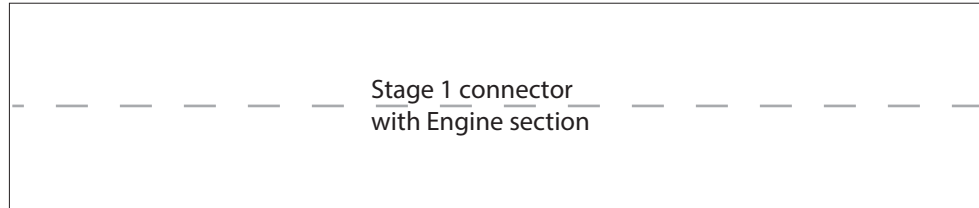

RD-181
Engines

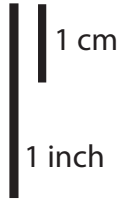

1:100 Scale

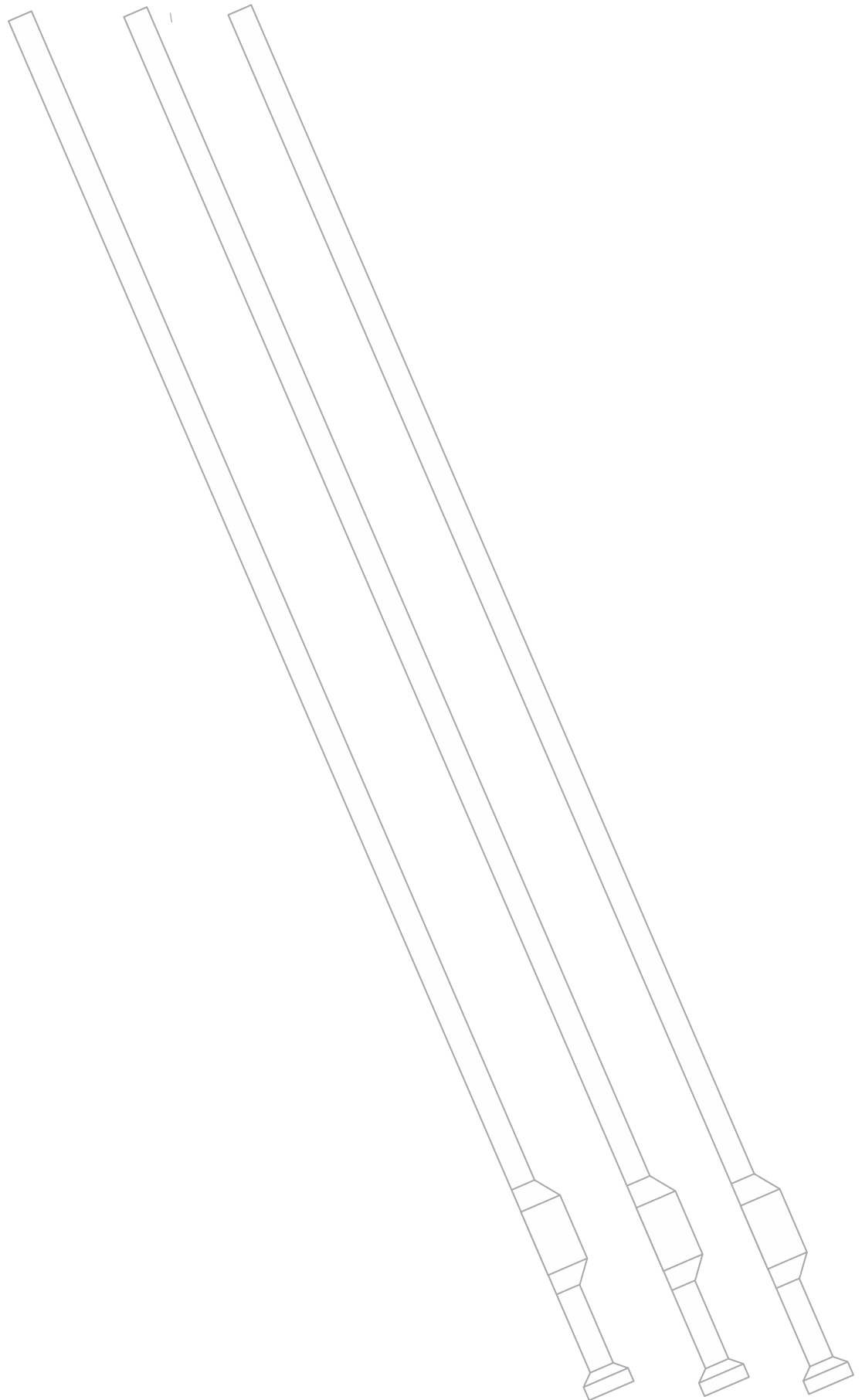



CYGNUS Cargo Vessel Castor 30 XL

Print on Cardstock (90 lbs)

Launch Configuration package



1:100 Scale

Solar Arrays Launch configuration

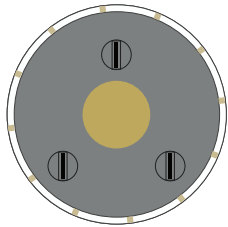
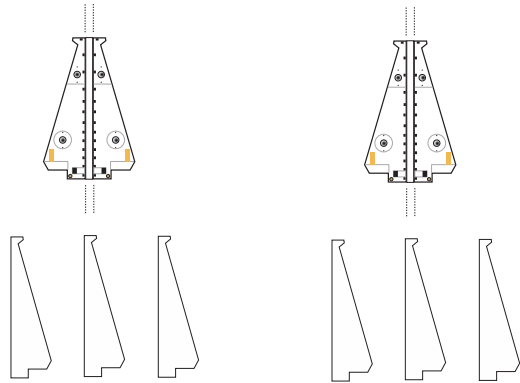

Launch Configuration only:
Replace the bottom of the
Cygnus model with this part
and don't install engine
nozzle and Grapple fixture.

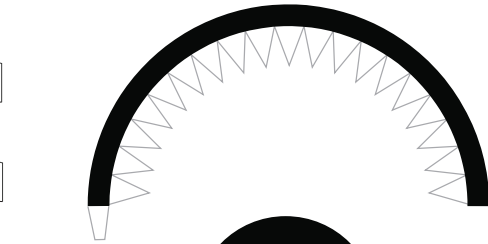
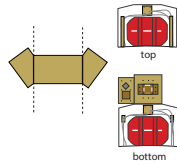

Castor 30 XL Solid Motor

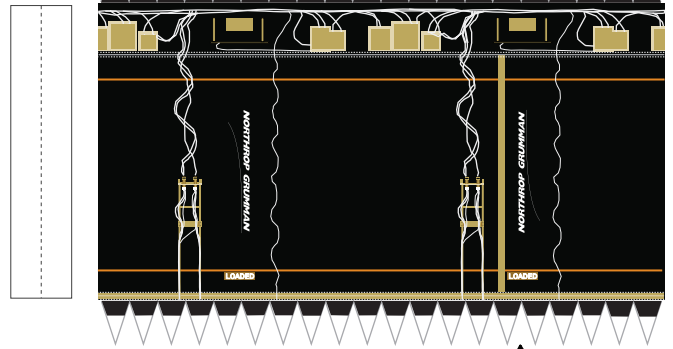
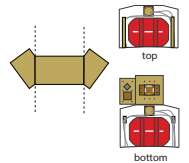

This side needs to
align with the logos
on Cygnus

Motor Cone

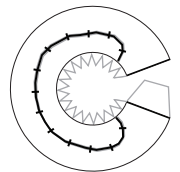
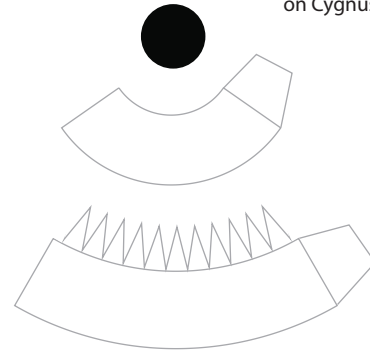
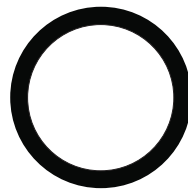
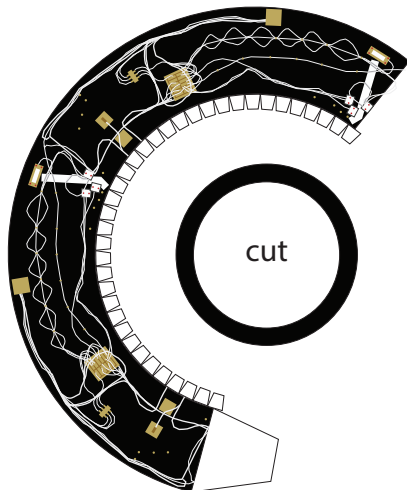

inner ring to support Motor cone

inner ring to support Motor cone



Northrop Grumman "ANTARES" / Cygnus

Print on Cardstock (110 lbs)

Base Template

(use foam board and glue stand cones)

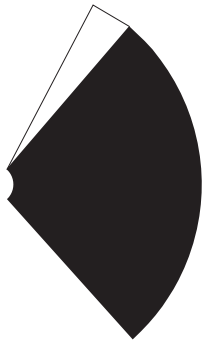
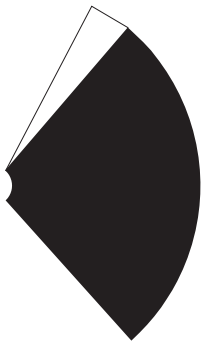

**NORTHROP
GRUMMAN**

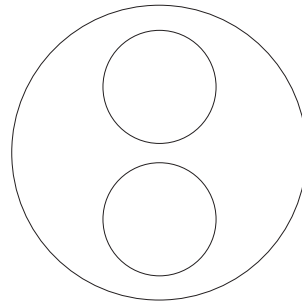

www.axmpaperspacescalemodels.com

1:100 Scale