

ATLAS V 500 Series

Print on Cardstock (110 lb)

Top of Fairing Shroud

1:96 Scale

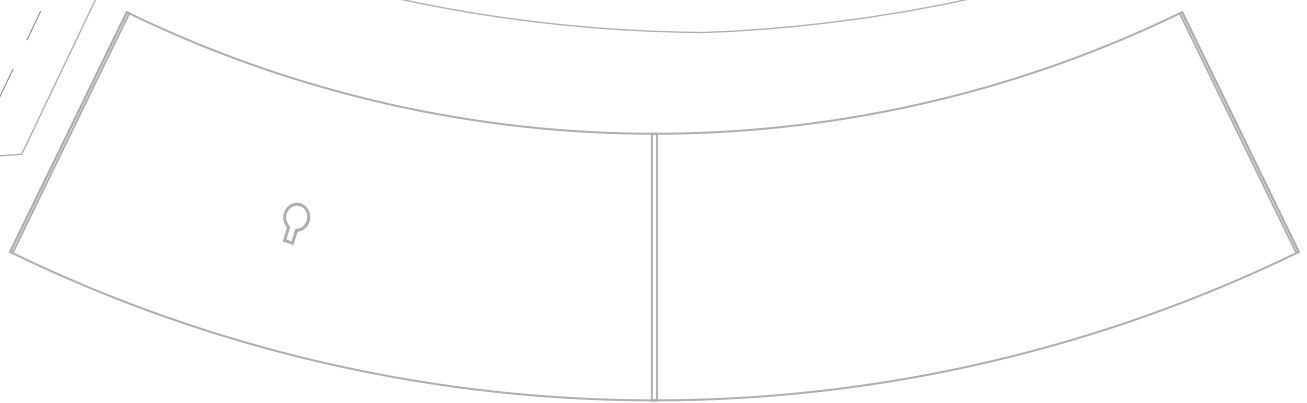
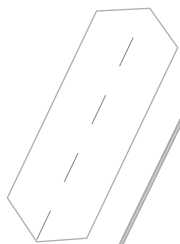
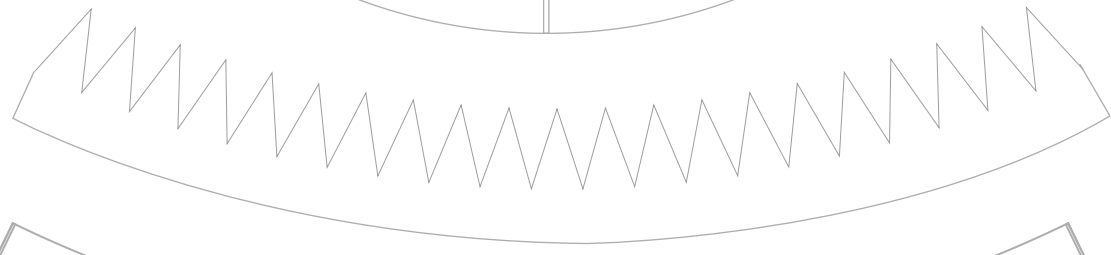
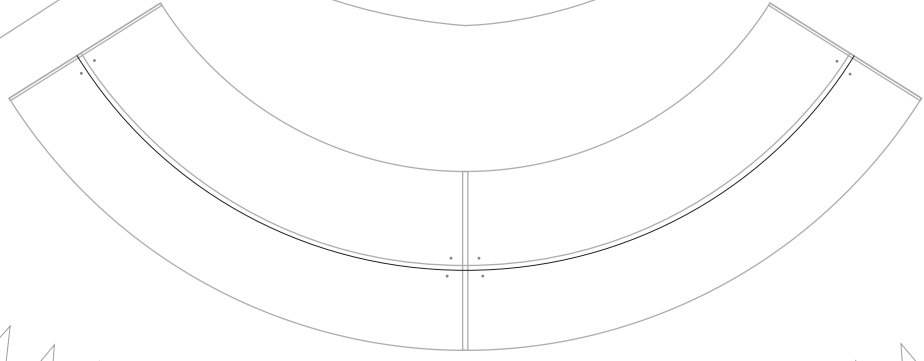
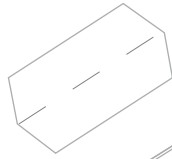
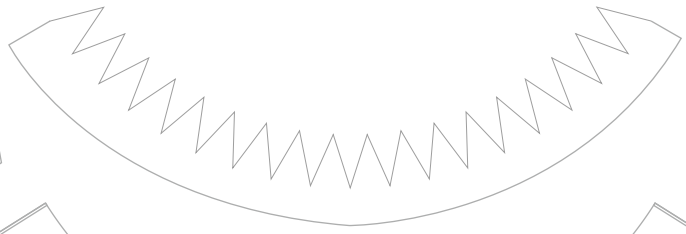
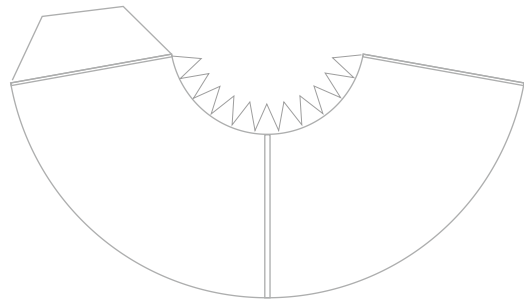



1 cm
1 inch

ATLAS V AEHF-4

Short Payload Fairing

Print on Cardstock (110 lb)

1:96 Scale

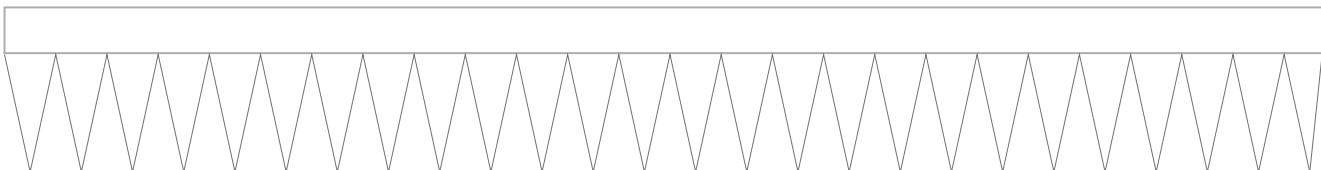
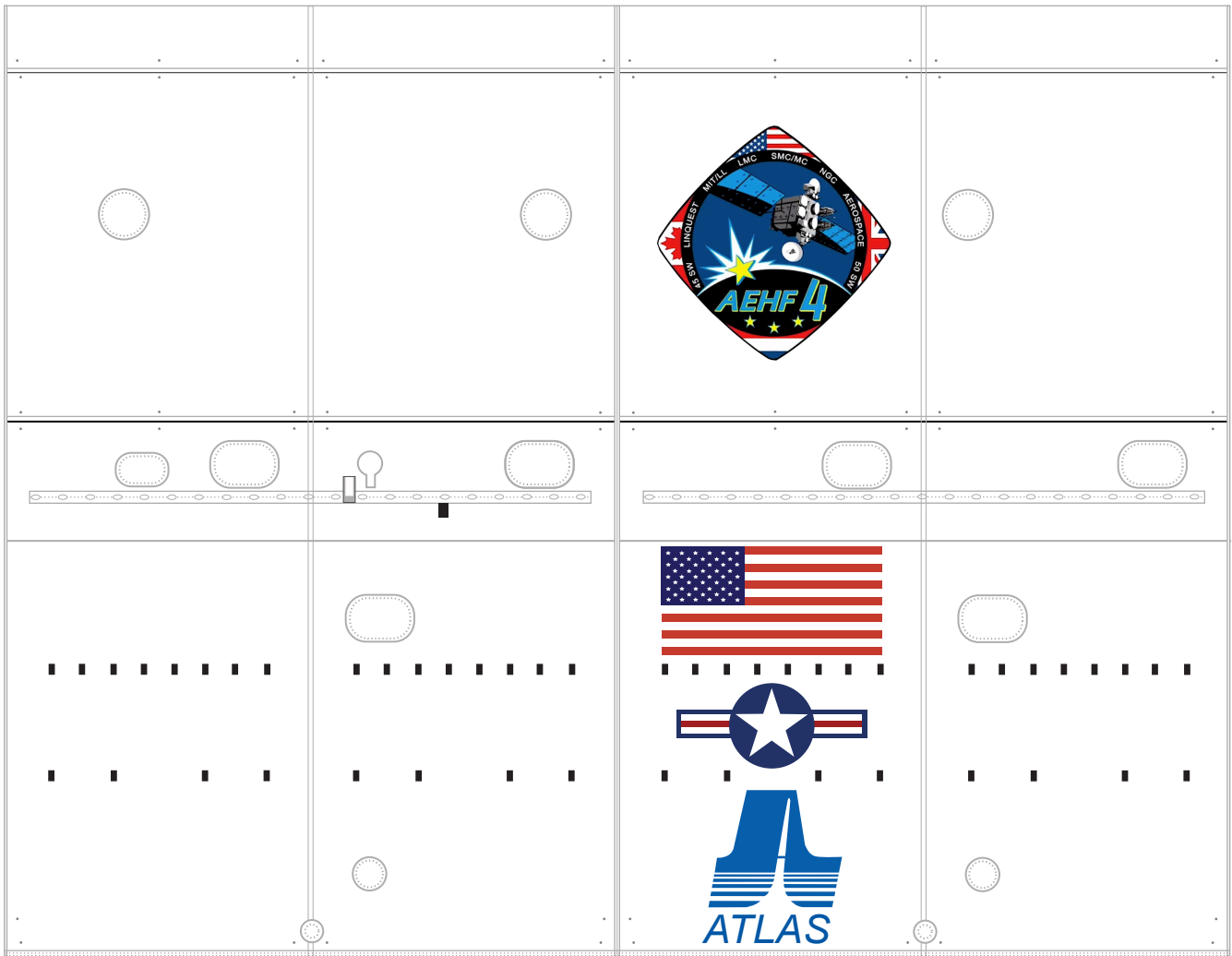
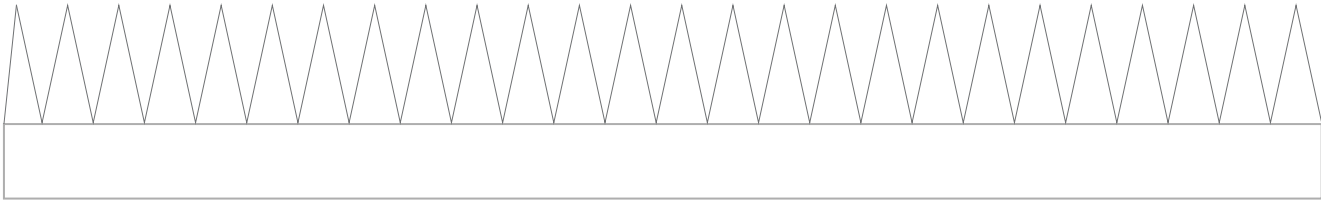
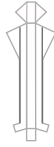



1 cm
1 inch

ATLAS V 500 Series

Print on Cardstock (110 lb)

Fairing Shroud and Common Core Booster Connectors

1:96 Scale

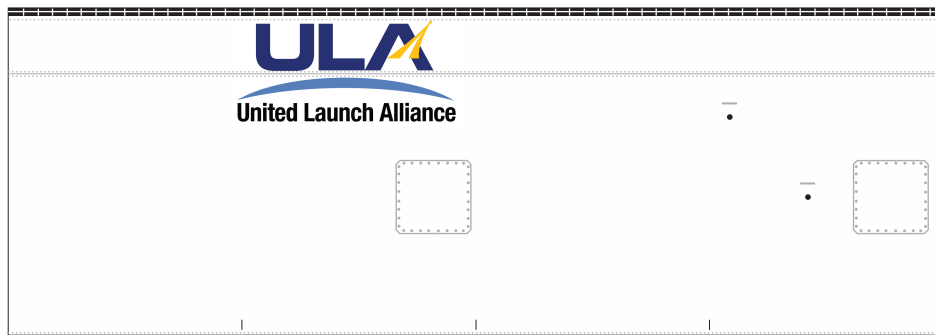
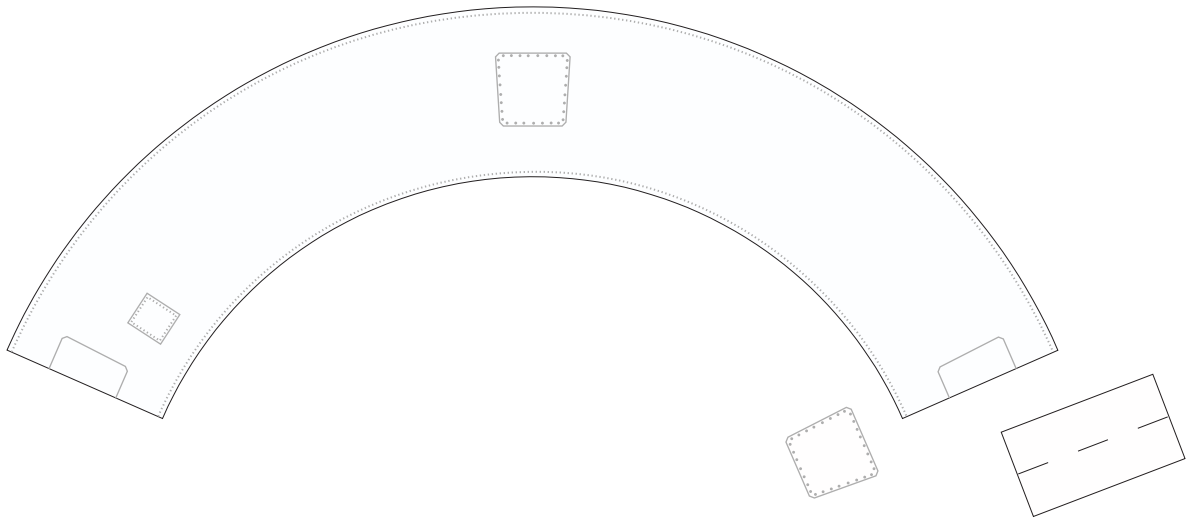



Print on Cardstock (110 lb)



ATLAS V Common Core Booster 500 Series

1:96 Scale

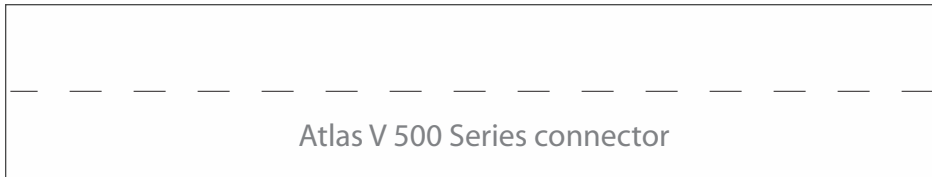

Common Core Booster

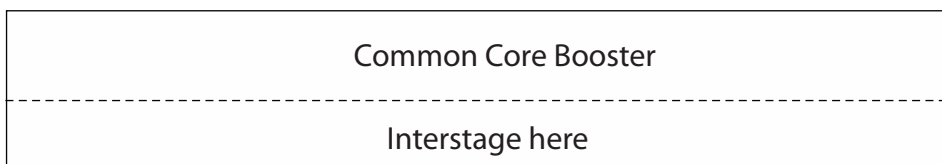
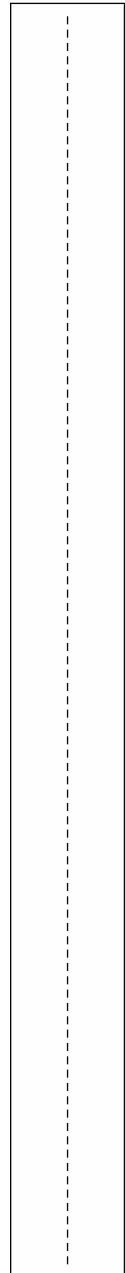
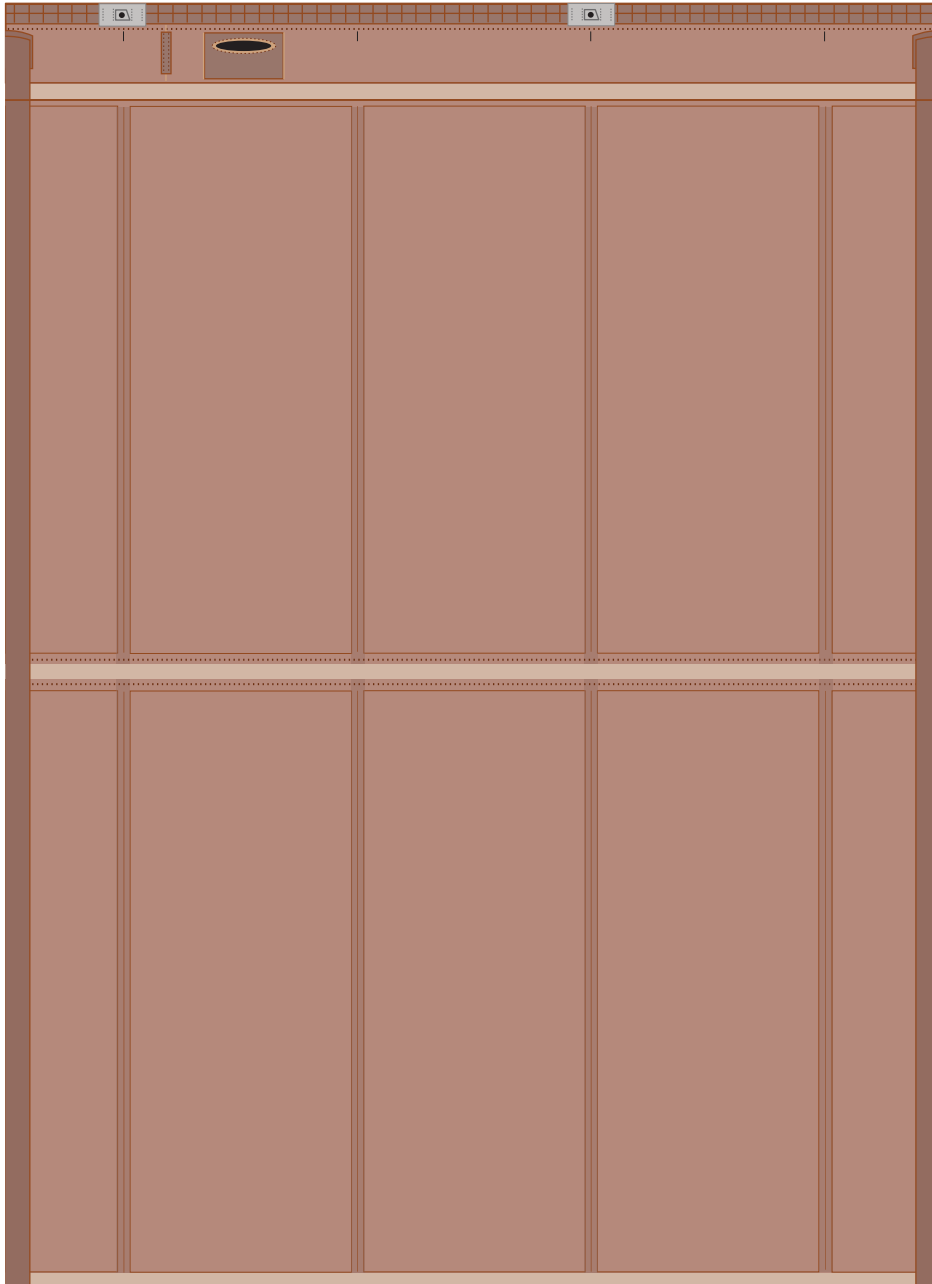



ATLAS V Common Core Booster 500 Series

1:96 Scale

Print on Metallic paper

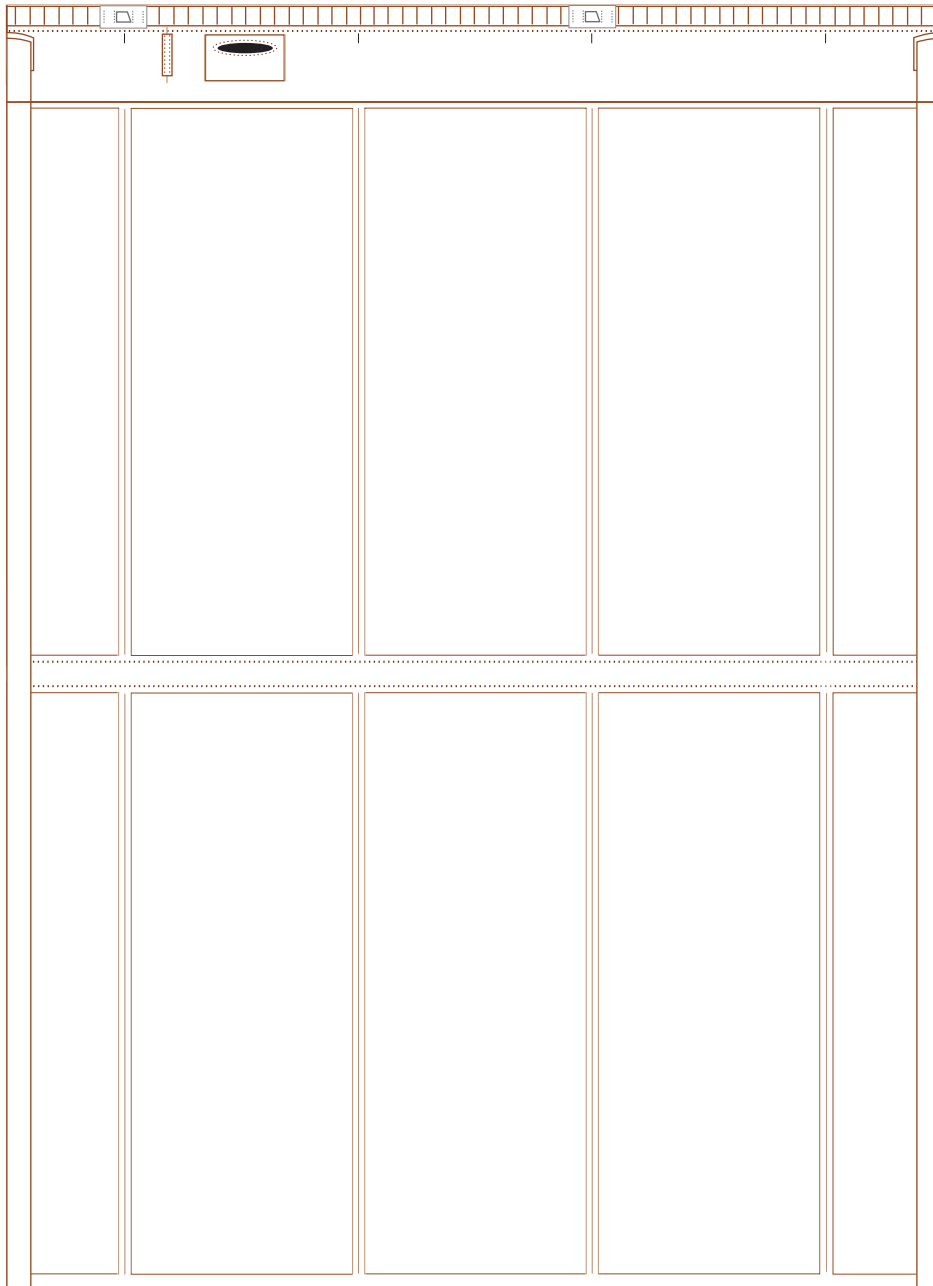



Print on Cardstock (110 lb)

ATLAS V Interstage Section

1:96 Scale



New Version 2016

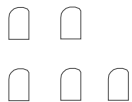
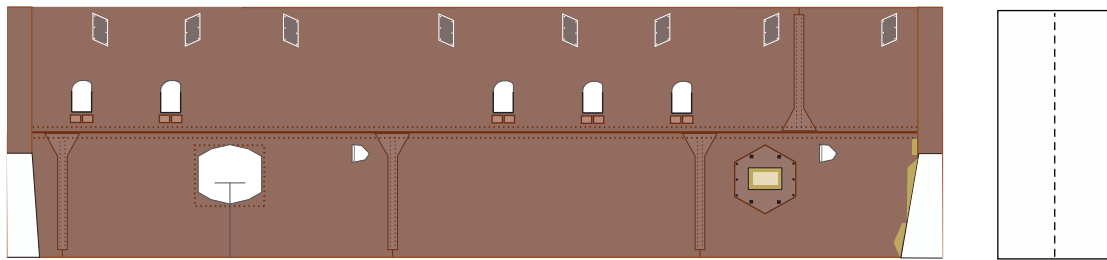

Glue a 2mm x 5 mm rod on the back of each attachment door to cover the openings on the Interstage section if no SRBs are used

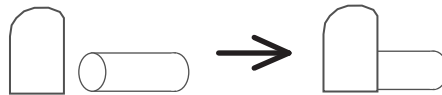



Print on Cardstock (110 lb)

ATLAS V Common Core Booster

Bottom section

1:96 Scale

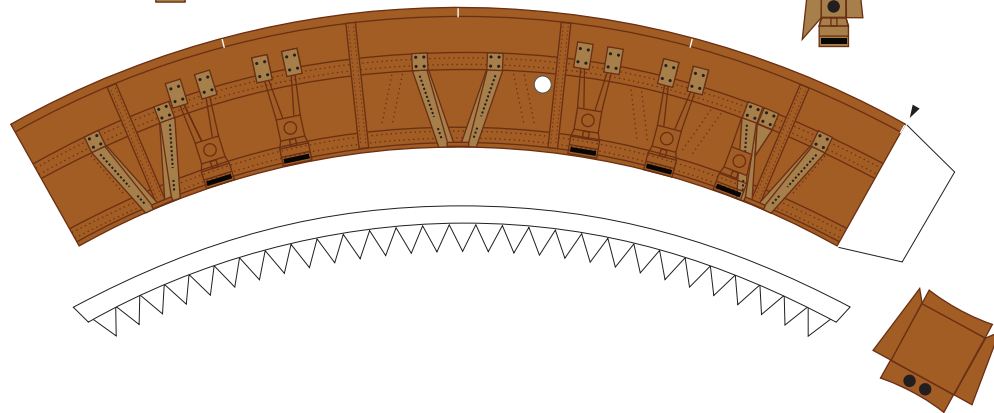
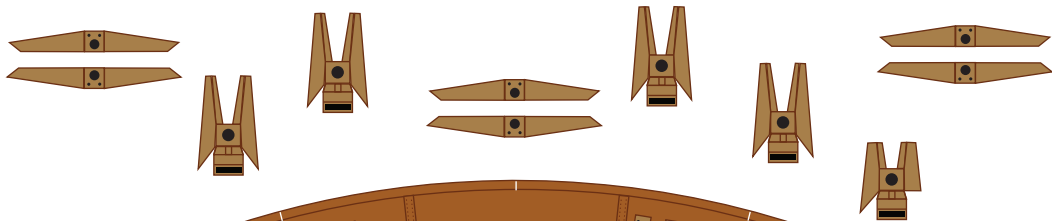
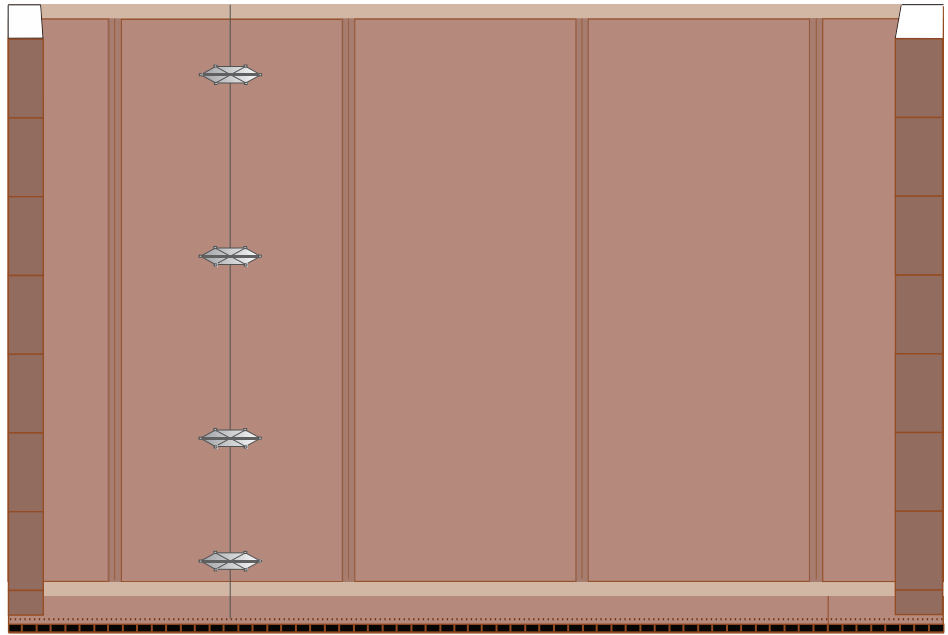
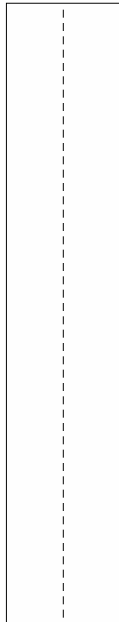
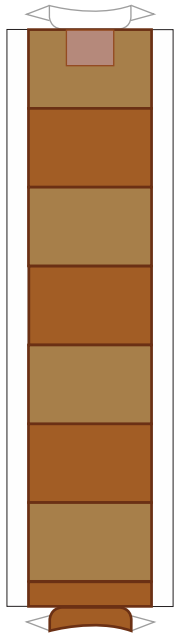
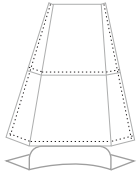



ATLAS V Common Core Booster

Bottom section

1:96 Scale

Print on Metallic paper

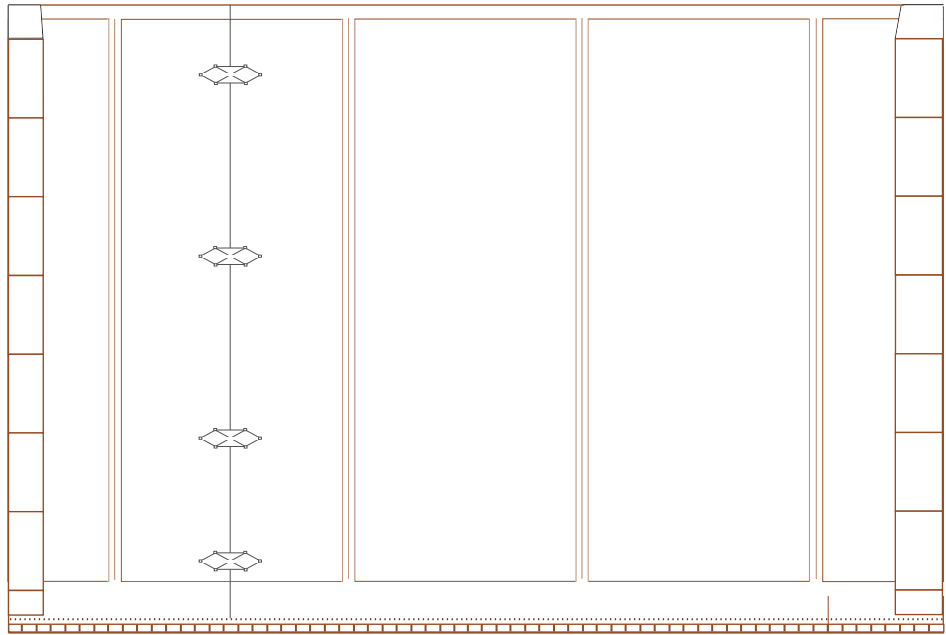



1:96 Scale



Atlas V Fuel line, Cable tray, Engines

Print on Cardstock (110 lb)

Rev.3/15

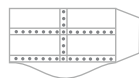
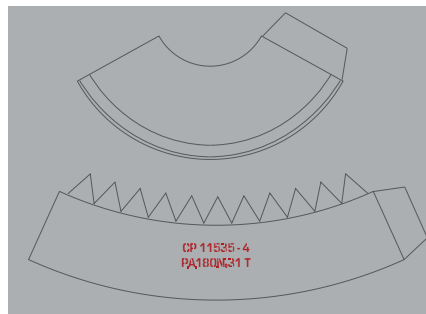
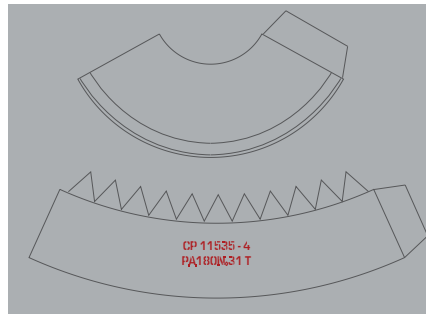
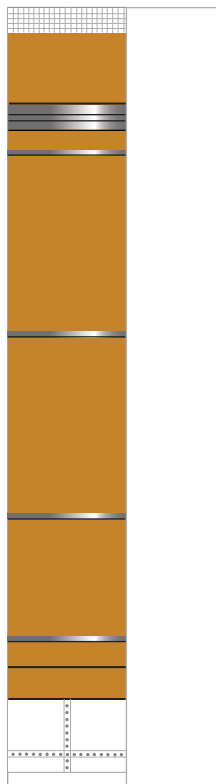
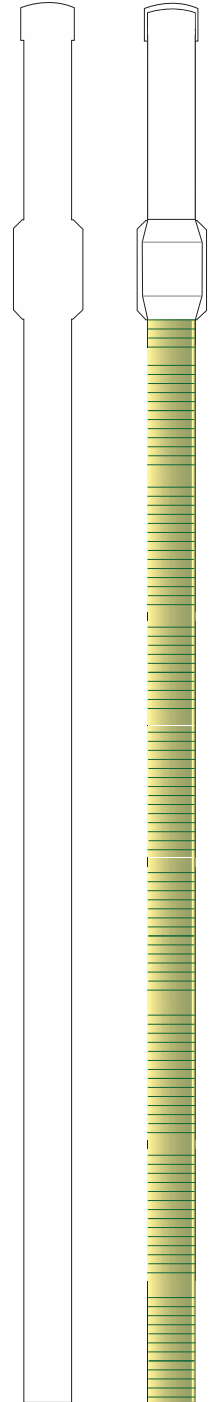
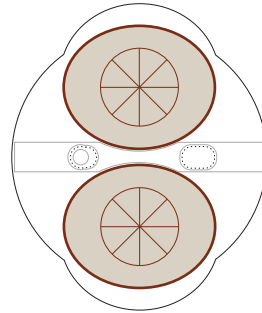
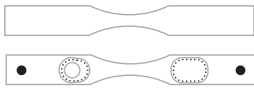
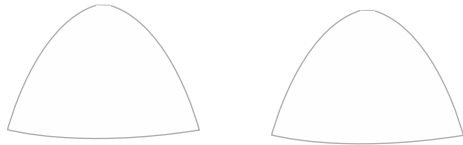
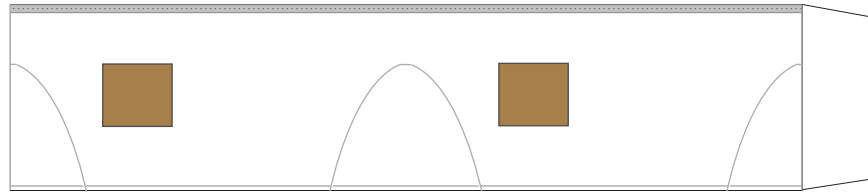



Print on Cardstock (110 lb)

ATLAS V Solid Rocket Booster

Print X 5 for 551 Series

1:96 Scale

Glue rod
(2 mm x 8 mm)

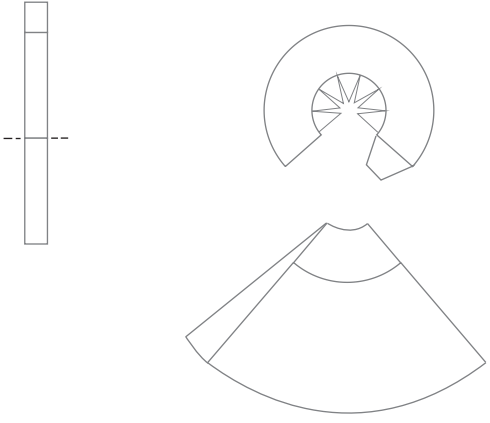
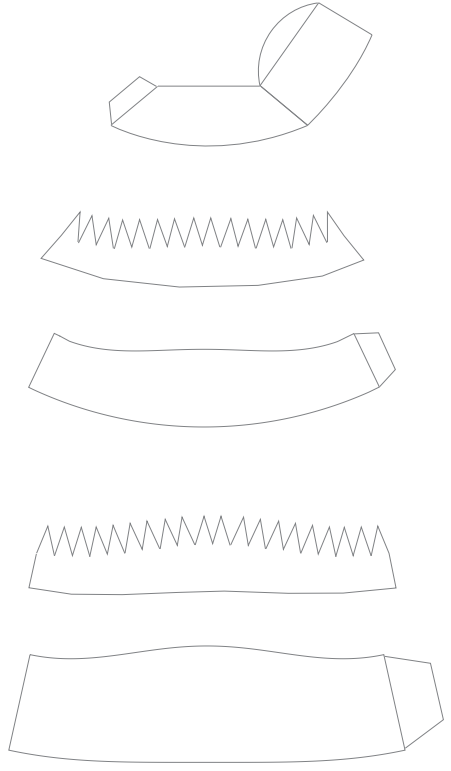
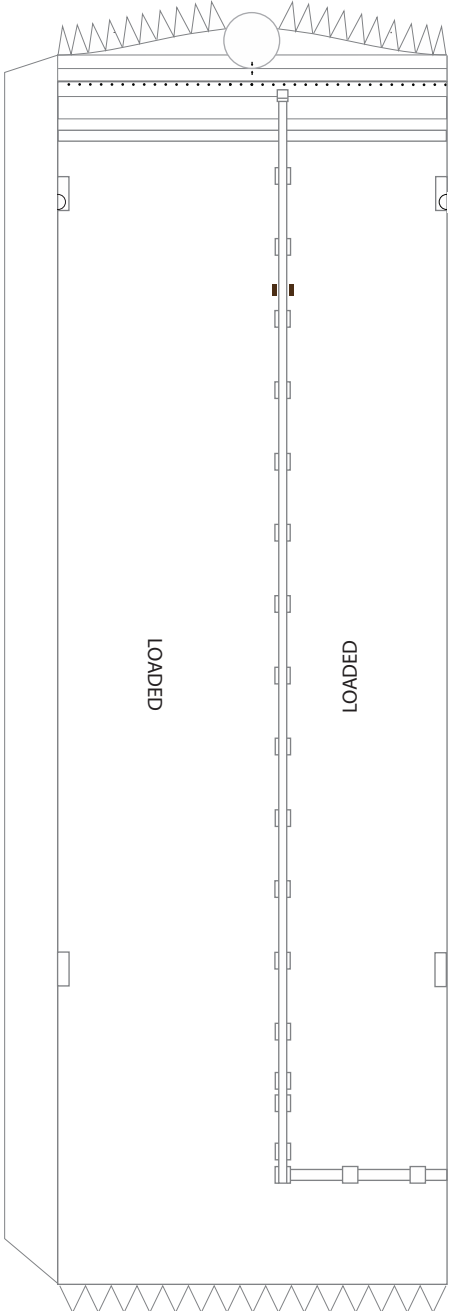



1:96 Scale

ATLAS V Common Core Booster Formers

Print on Cardstock (110 lb)

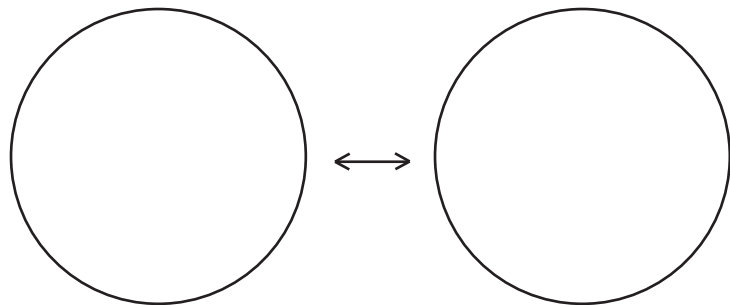
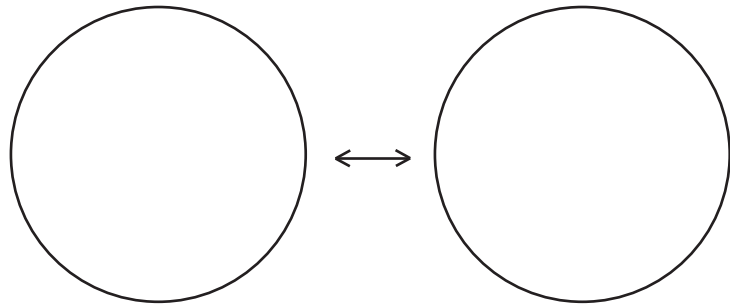
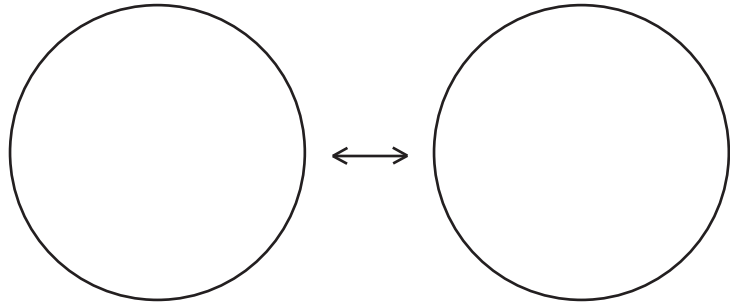
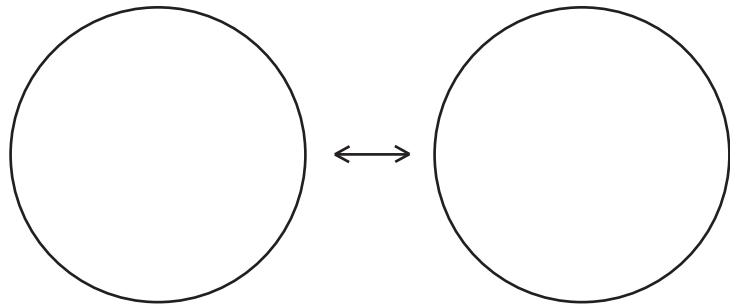
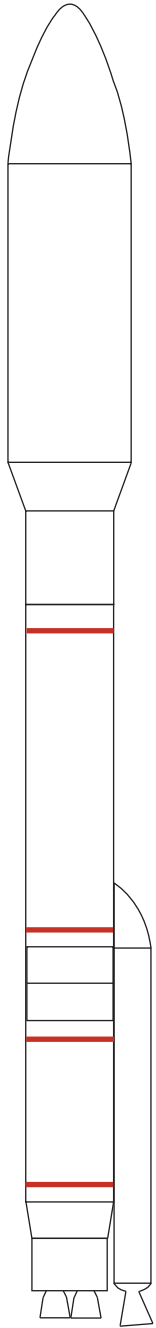



Print on Cardstock (110 lb)

Atlas V Base template

(use foam board and glue stand cones)

1:96 Scale

