



ATLAS V 500 Series

Print on Cardstock (110 lb)

Top of Fairing Shroud

1:96 Scale

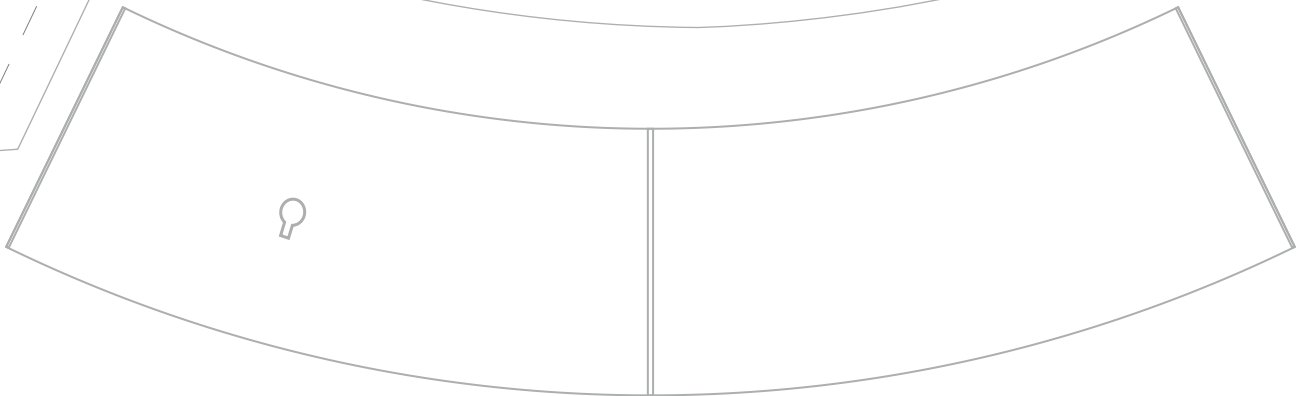
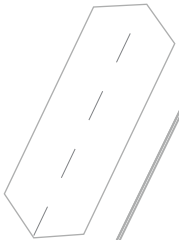
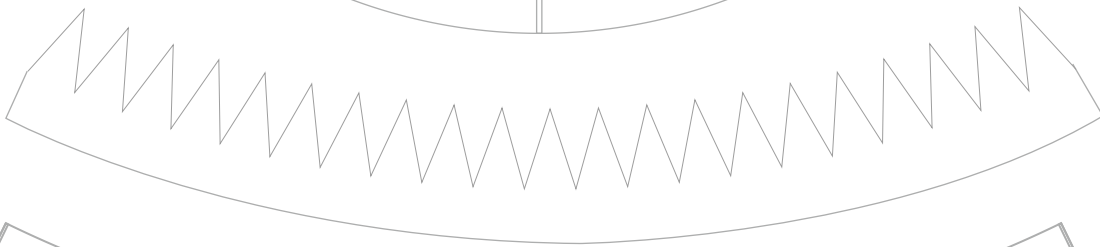
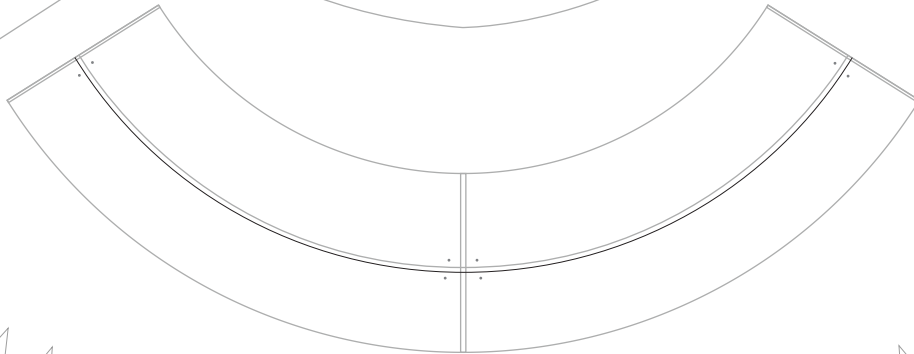
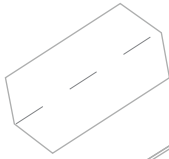
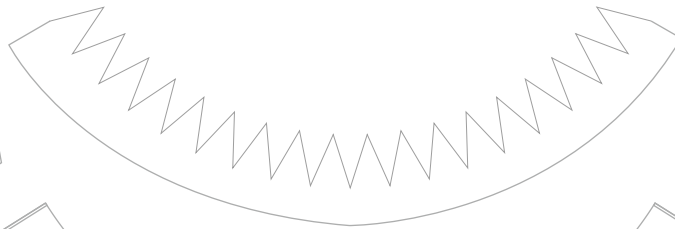
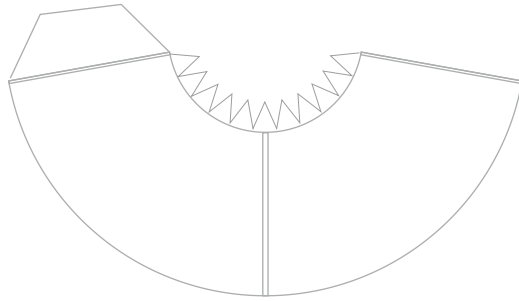



1 cm
1 inch

ATLAS V AEHF-6

Short Payload Fairing

Print on Cardstock (110 lb)

1:96 Scale

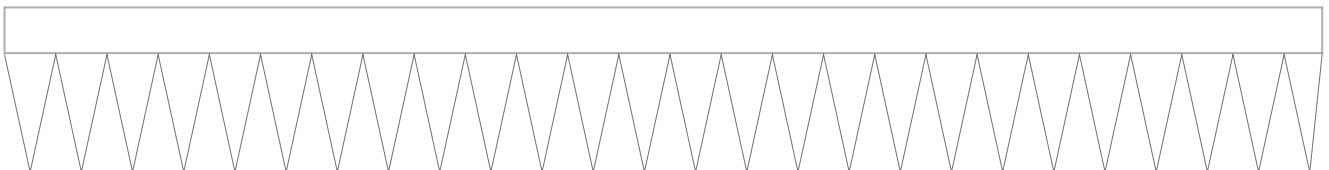
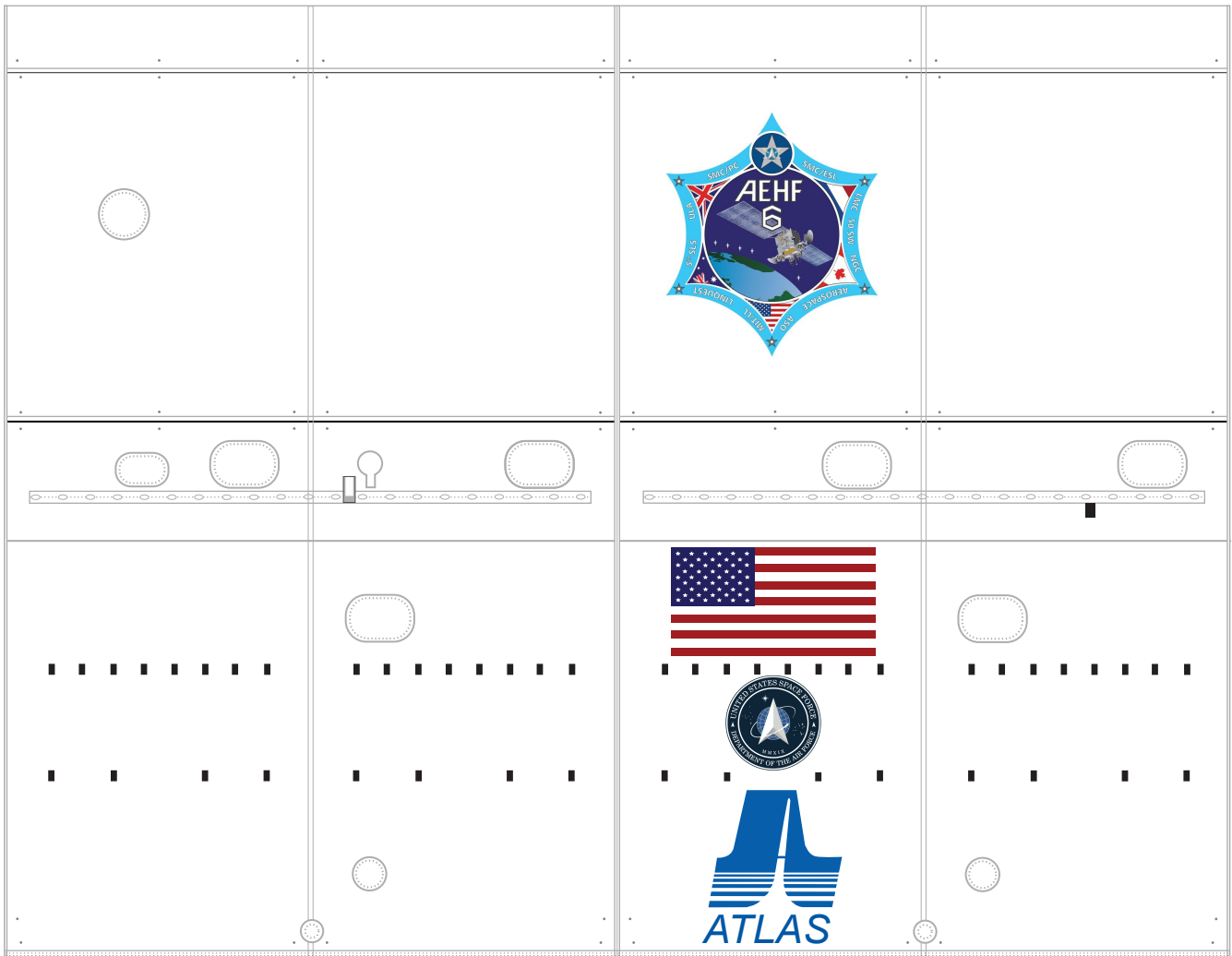
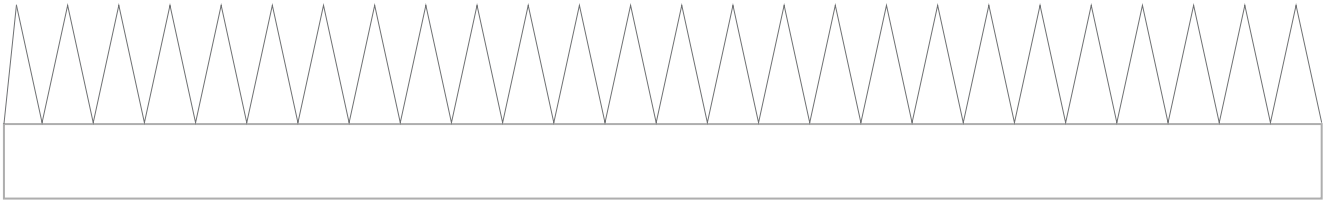
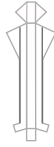



1 cm
1 inch

ATLAS V 500 Series

Print on Cardstock (110 lb)

Fairing Shroud and Common Core Booster Connectors

1:96 Scale

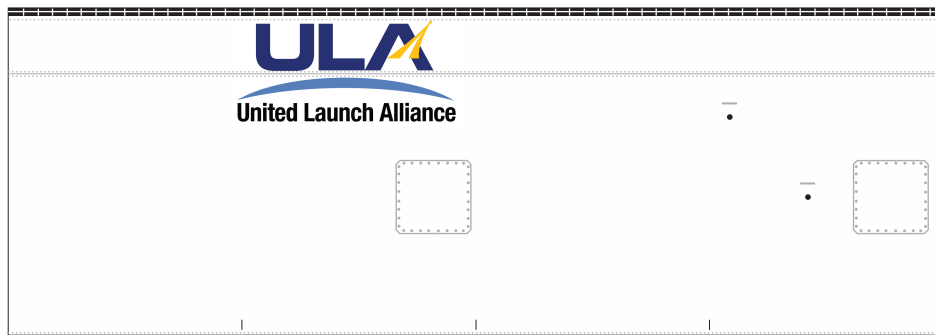
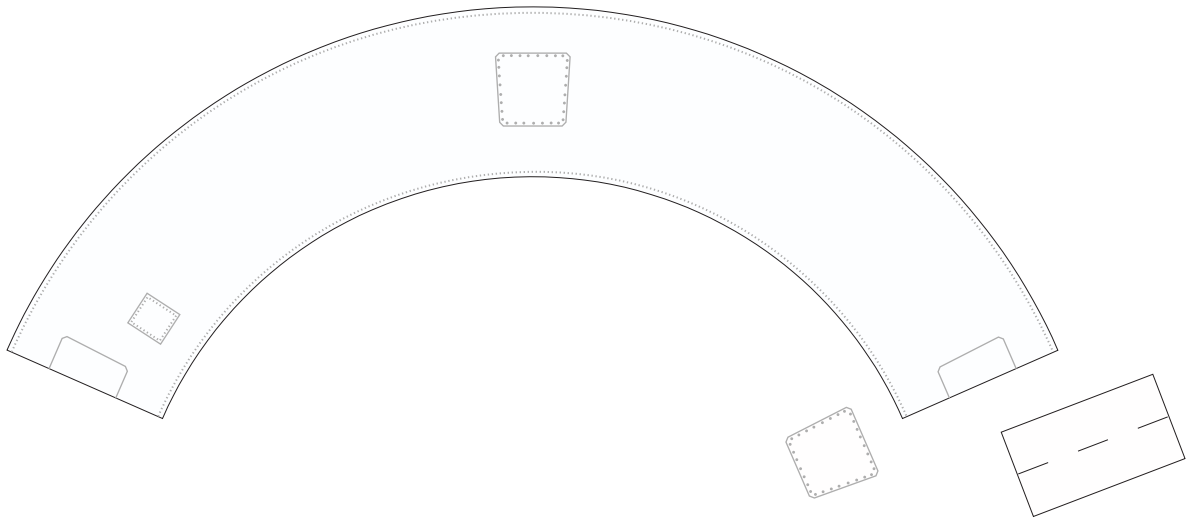



1 cm
1 inch

Print on Cardstock (110 lb)

ATLAS V Common Core Booster 500 Series

1:96 Scale

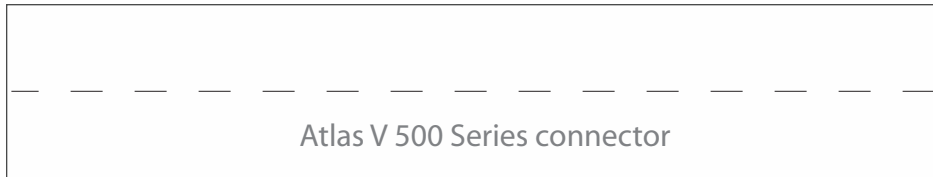

Common Core Booster

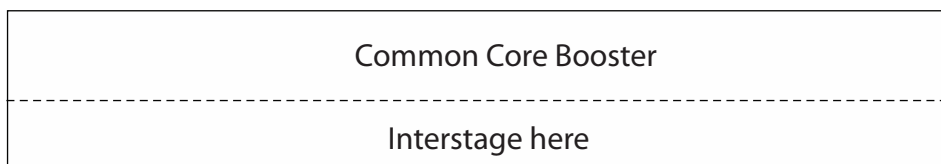
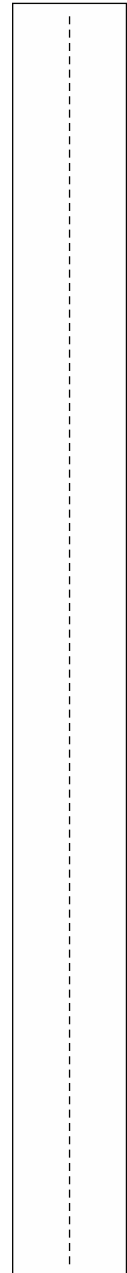
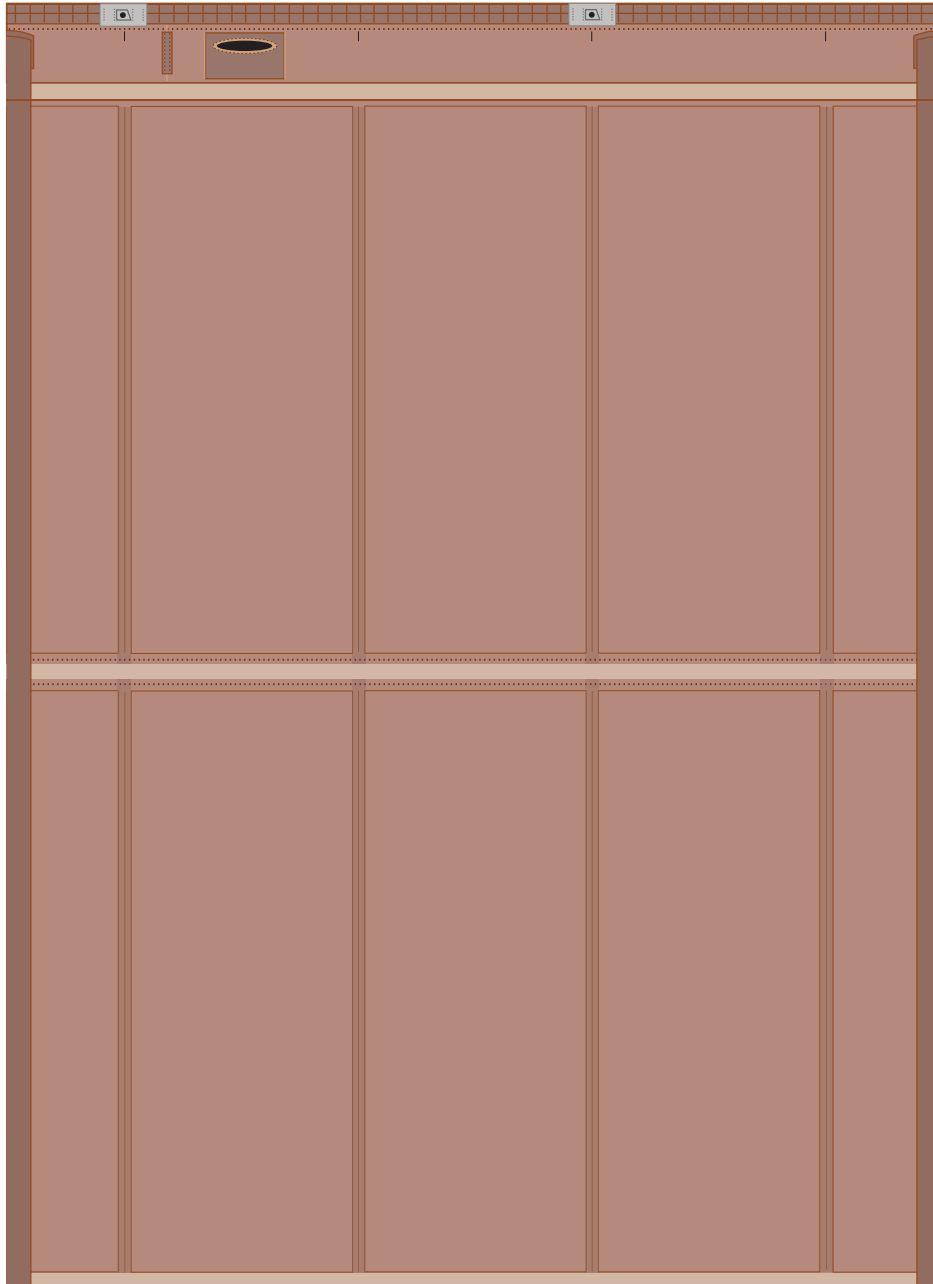



Print on Cardstock (110 lb)

ATLAS V Interstage Section

1:96 Scale



New Version 2020

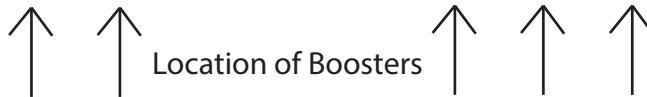
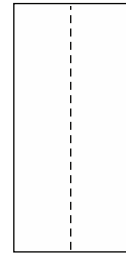
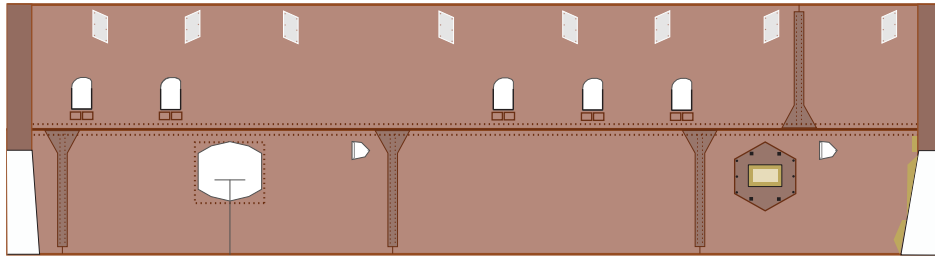

Location of Boosters

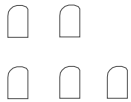

Glue a 2mm x 5 mm rod on the back of each attachment door to cover the openings on the Interstage section if no SRBs are used

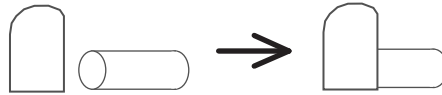



Print on Cardstock (110 lb)

ATLAS V Common Core Booster

Bottom section

1:96 Scale

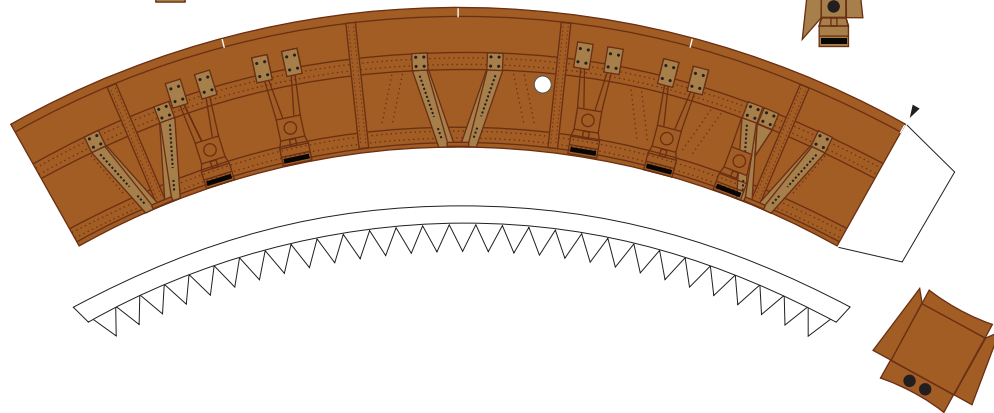
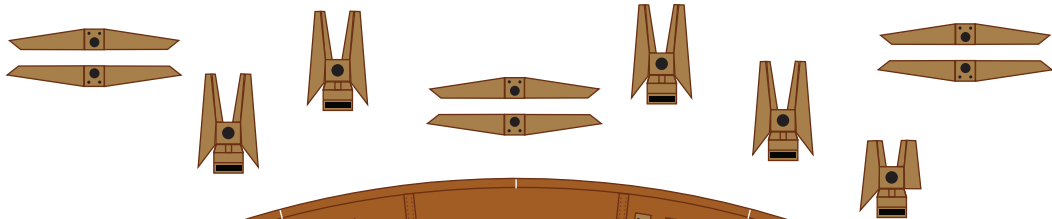
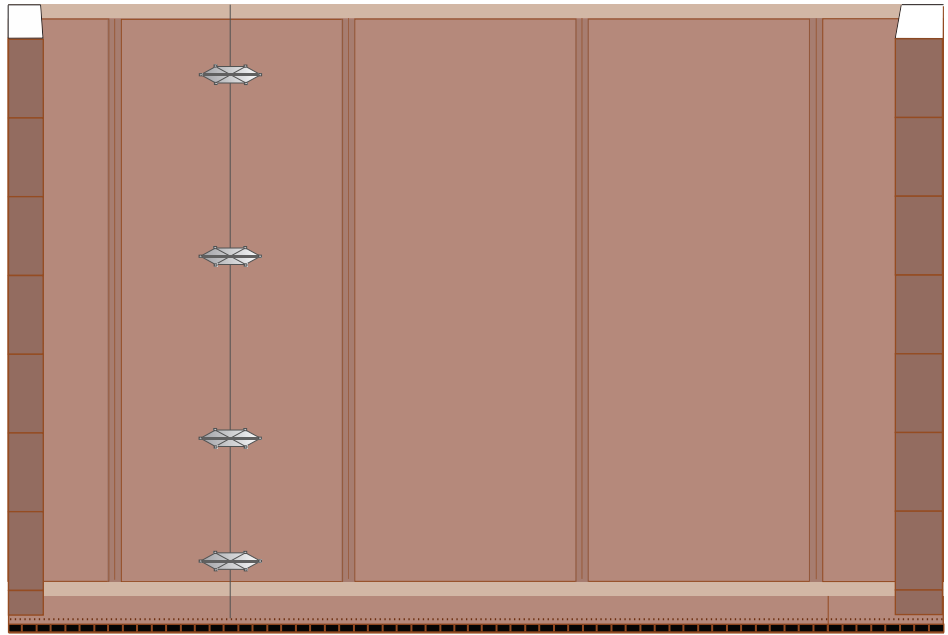
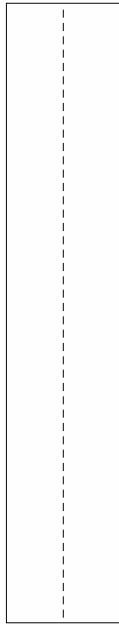
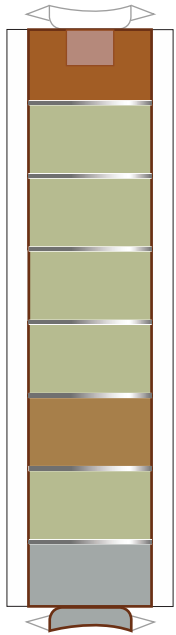
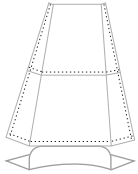



1:96 Scale



Atlas V Fuel line, Cable tray, Engines

Print on Cardstock (110 lb)

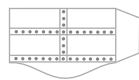
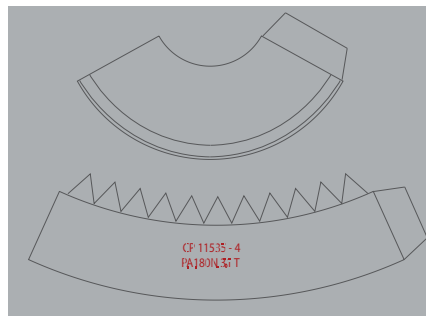
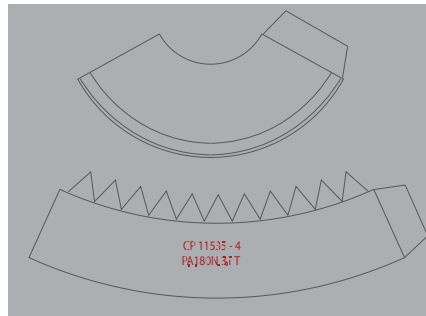
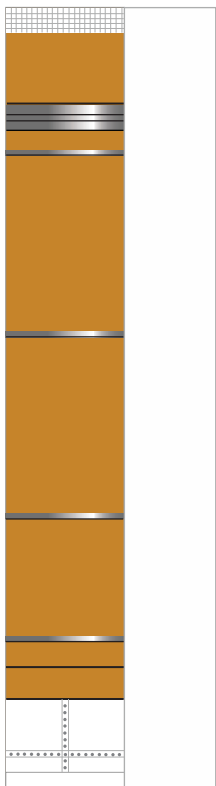
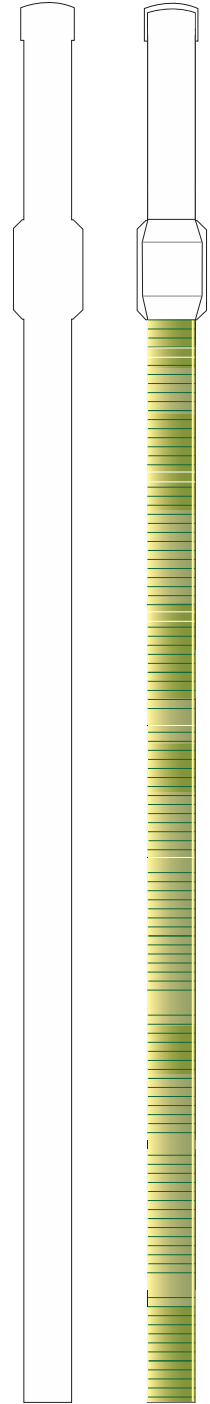
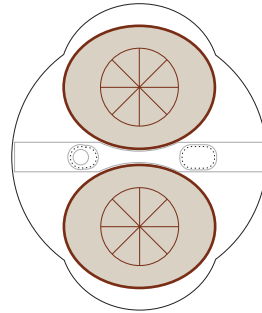
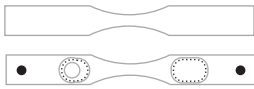
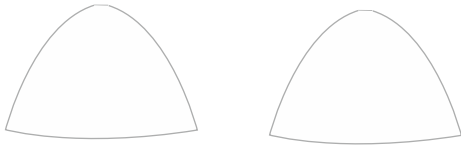
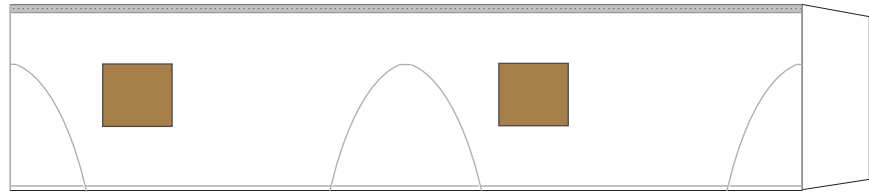



1 cm
1 inch

Print on Cardstock (110 lb)

ATLAS V Solid Rocket Booster

PRINT X 5

1:96 Scale

Glue rod
(2 mm x 8 mm)

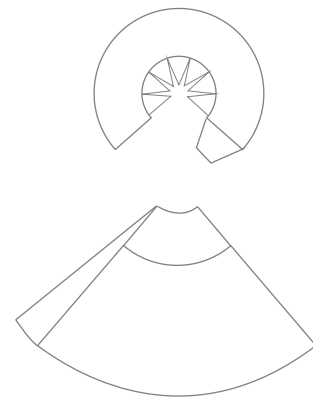
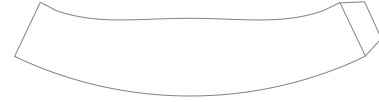
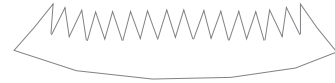
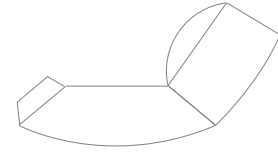
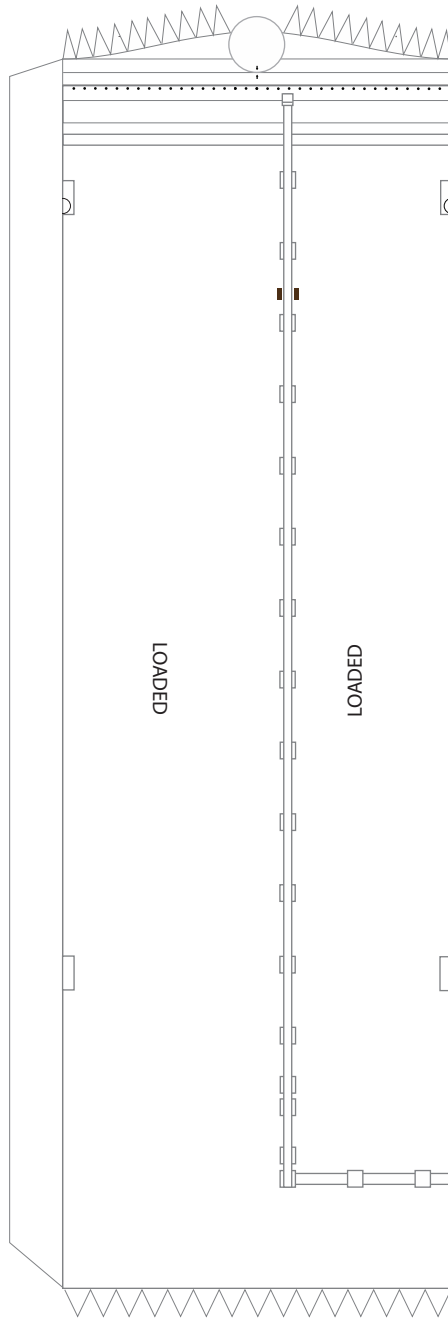
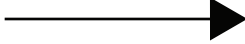



Print on Cardstock (110 lb)

Atlas V Base template

(use foam board and glue stand cones)

1:96 Scale

cut

cut



Atlas V 551 AEHF-6

www.axmpapermodels.com

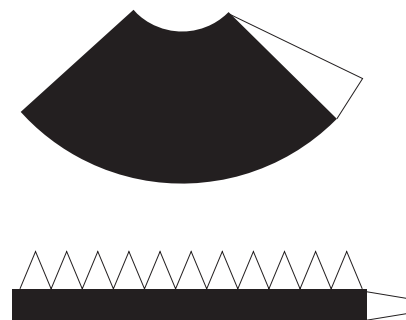
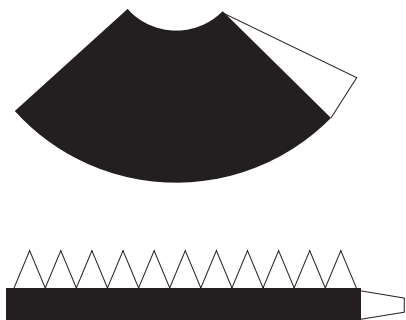



1:96 Scale

ATLAS V Common Core Booster Formers

Print on Cardstock (110 lb)

