



1 cm
1 inch

ATLAS V Insight

Print on Cardstock (110 lb)

1:96 Scale

4 m LPF

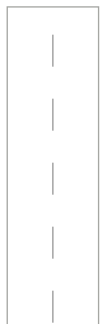
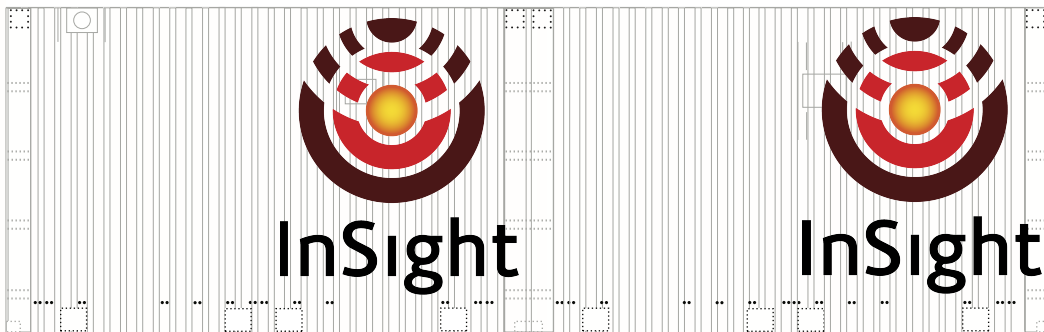
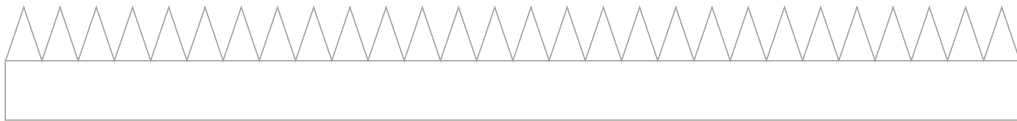
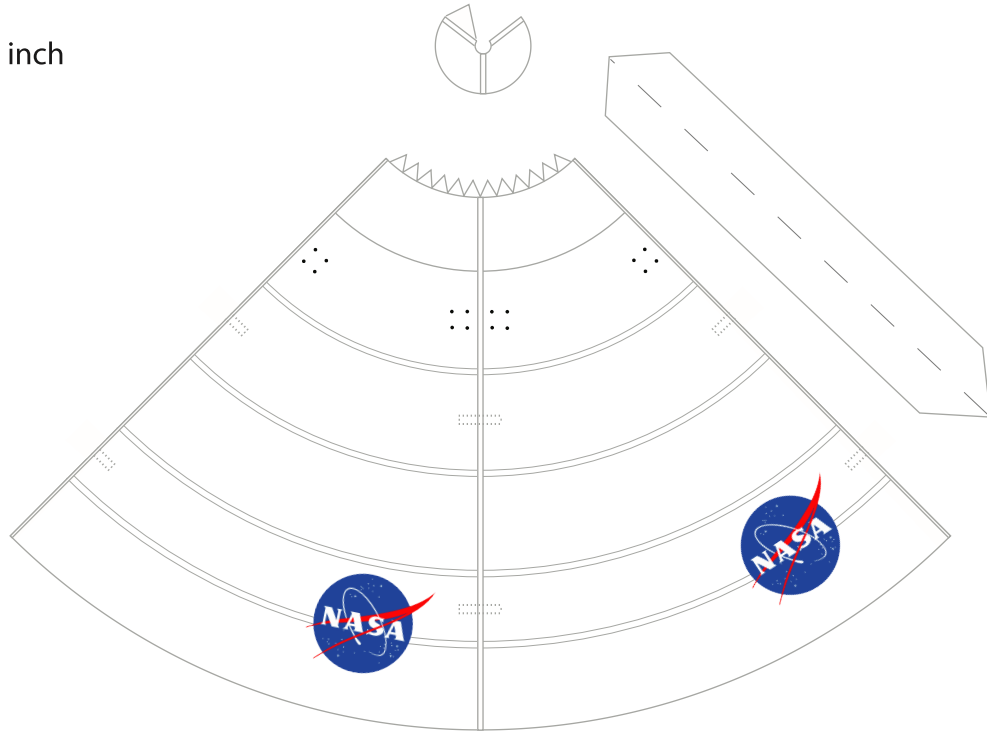



1 cm
1 inch

ATLAS V

Print on Cardstock (110 lb)

1:96 Scale

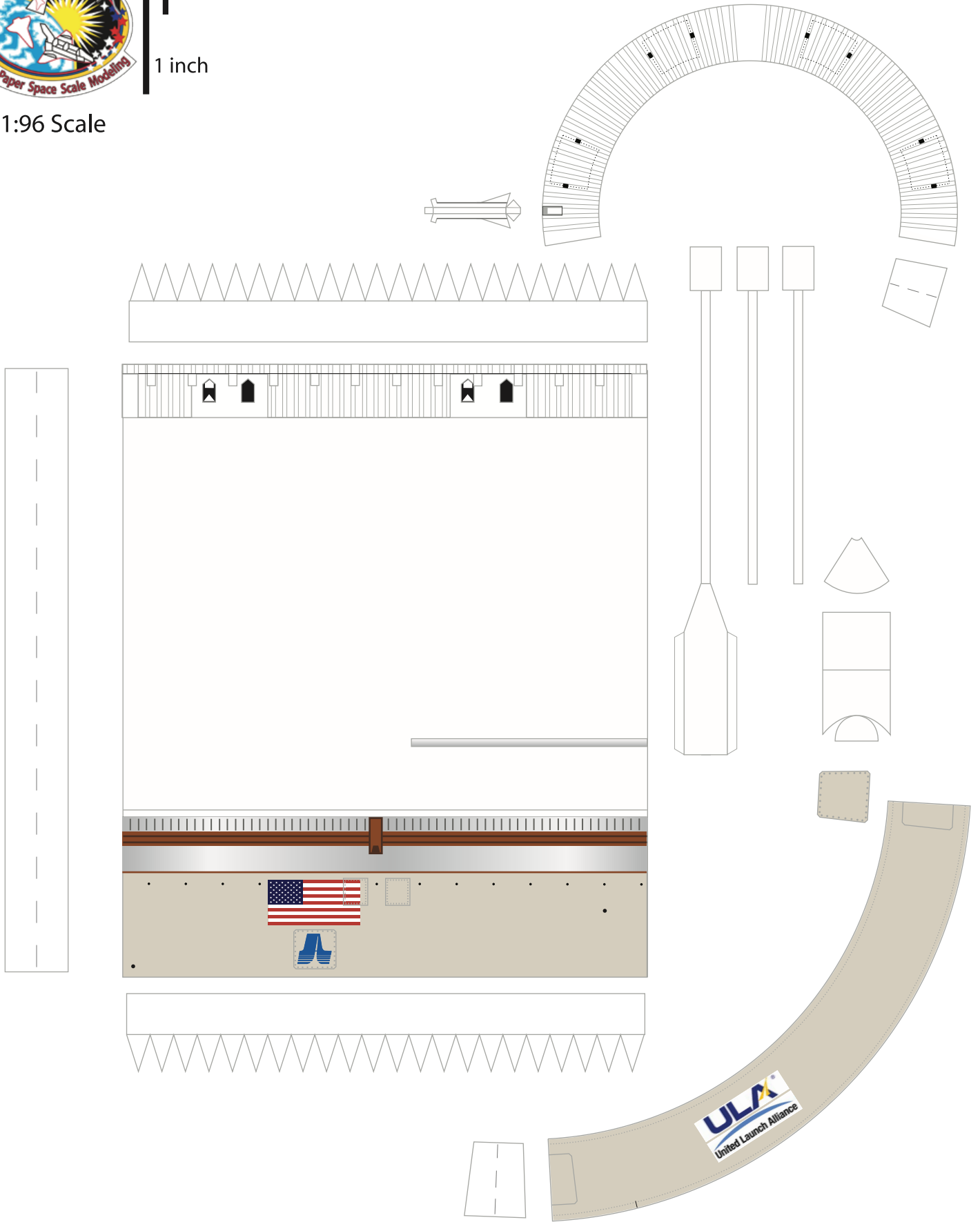



Print on Cardstock (110 lb)

1 cm

ATLAS V Common Core Booster 400 Series

1 inch

1:96 Scale



Common Core Booster

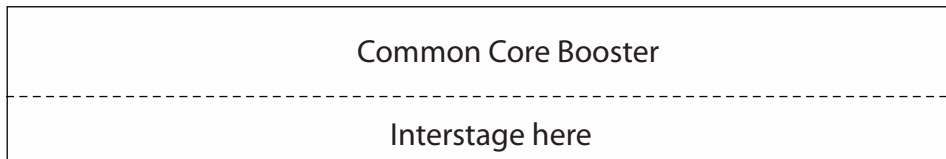
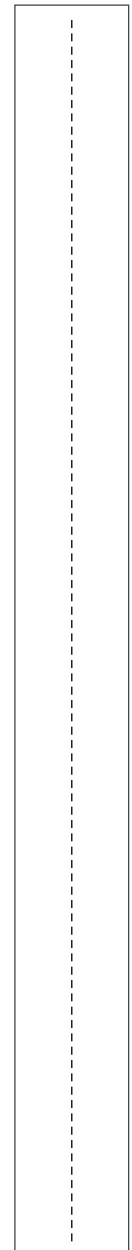
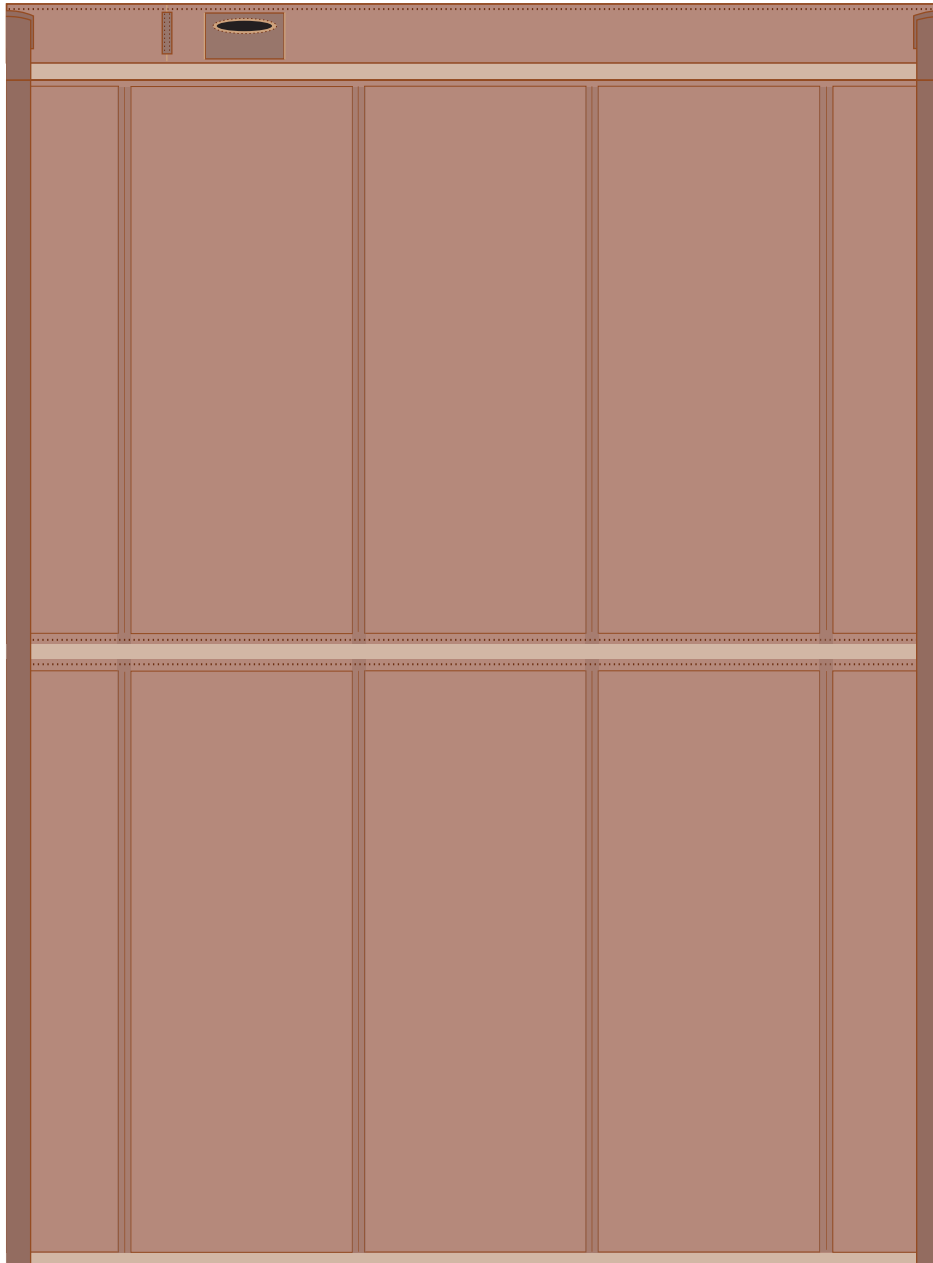



Print on Cardstock (110 lb)

ATLAS V Interstage Section

1:96 Scale



New Version 2016

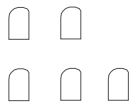
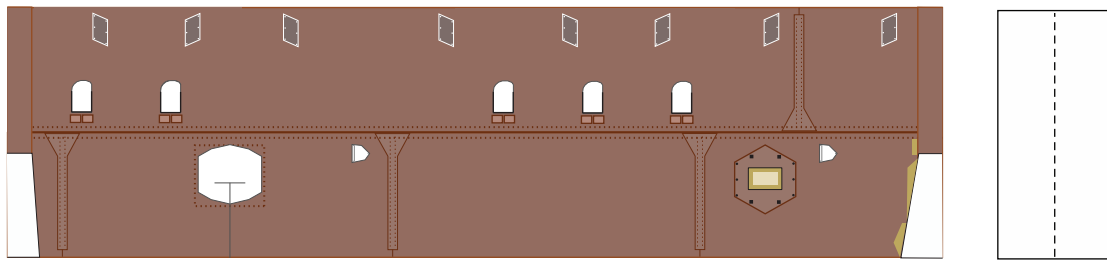

Glue a 2mm x 5 mm rod on the back of each attachment door to cover the openings on the Interstage section if no SRBs are used

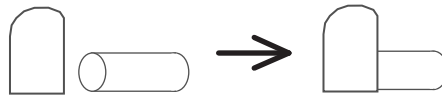



Print on Cardstock (110 lb)

ATLAS V Common Core Booster

Bottom section

1:96 Scale

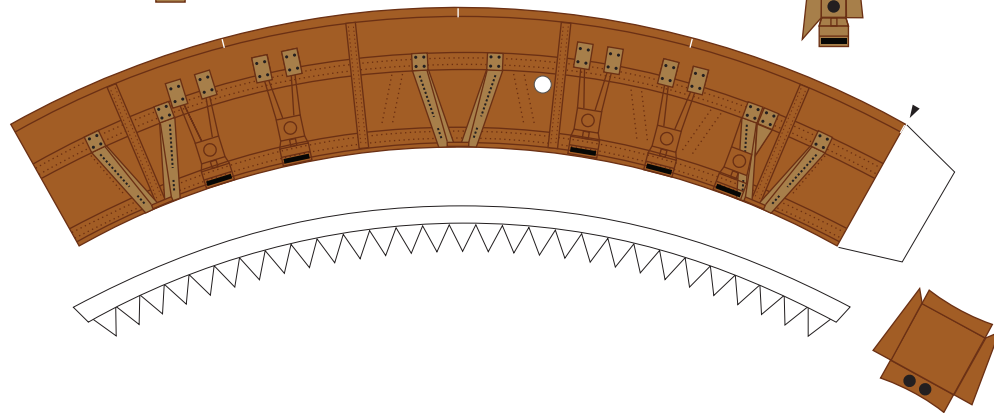
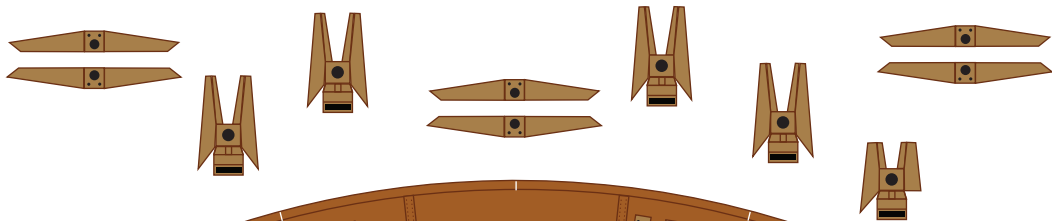
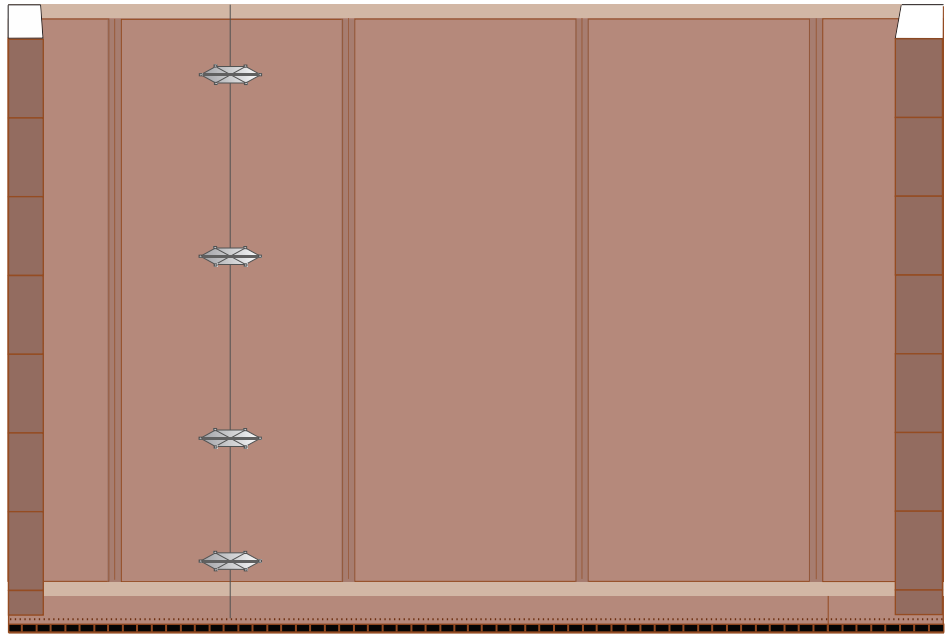
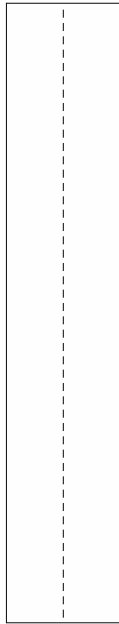
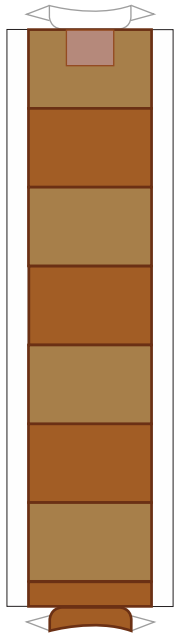
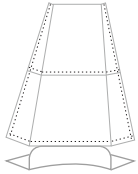



1:96 Scale



Atlas V Fuel line, Cable tray, Engines

Print on Cardstock (110 lb)

Rev.3/15

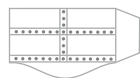
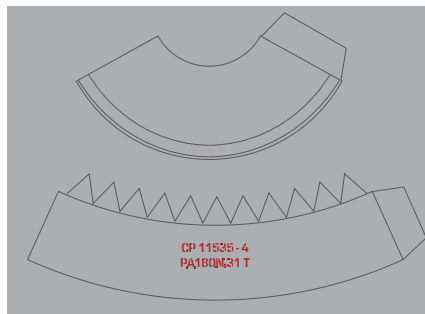
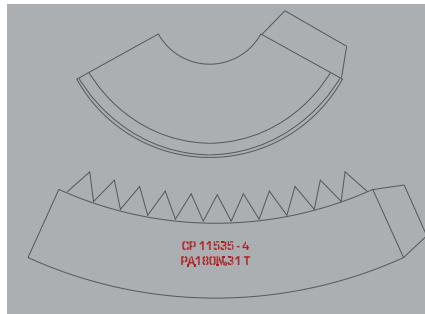
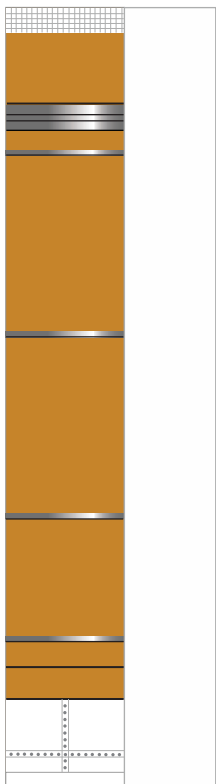
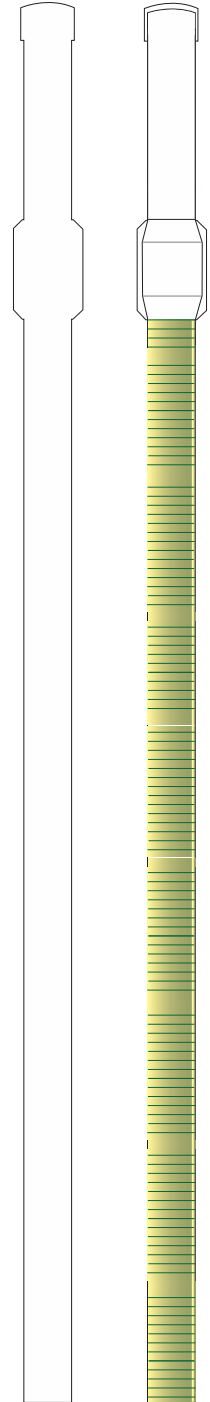
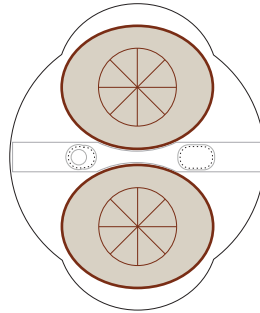
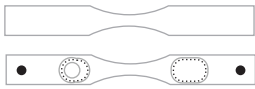
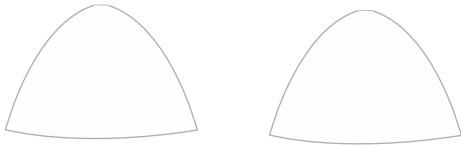
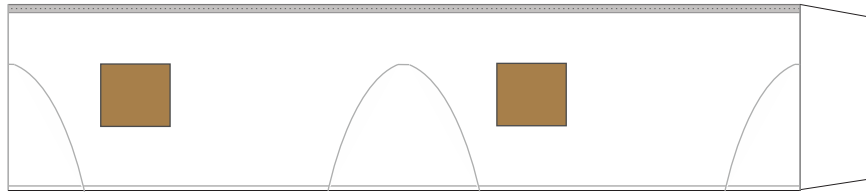

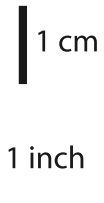

1:96 Scale

ATLAS V Common Core Booster Formers

Print on Cardstock (110 lb)

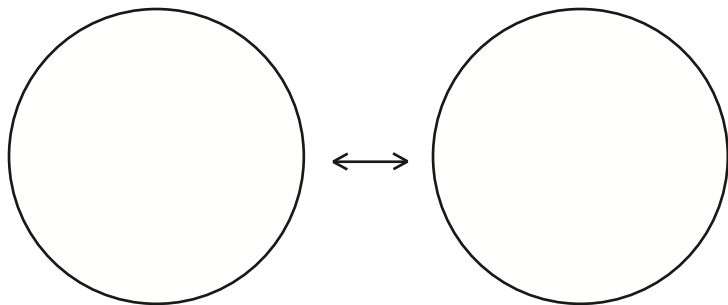
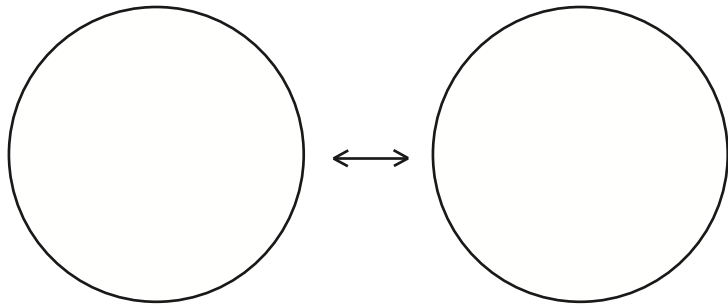
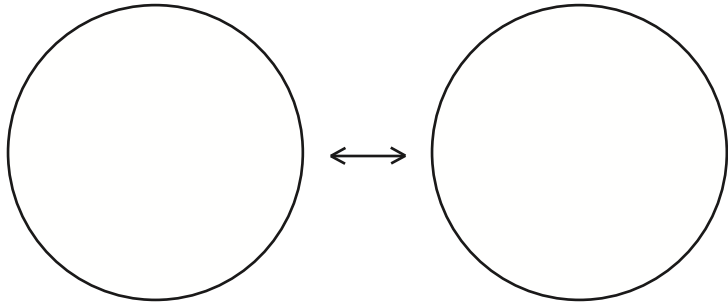
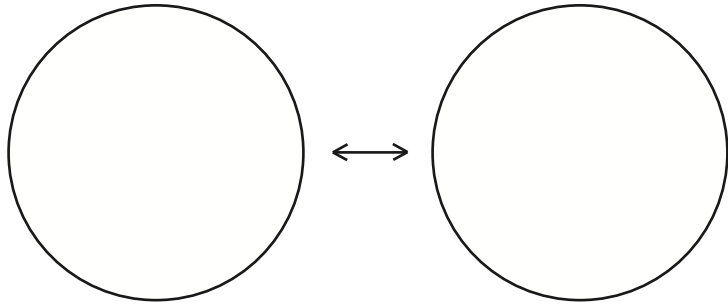
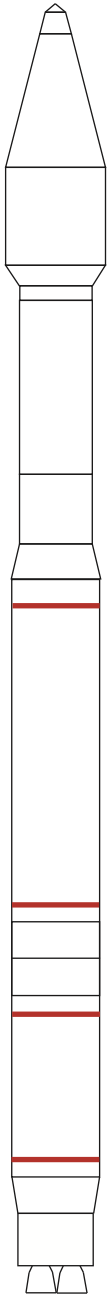



Print on Cardstock (110 lb)

Atlas V Base template

(use foam board and glue stand cones)

1:96 Scale



Atlas V 401 AV-078

www.axmpapermodels.com

