



1 cm
1 inch

ATLAS V

Print on Cardstock (110 lb)

Solar Orbiter

1:96 Scale

4 m LPF

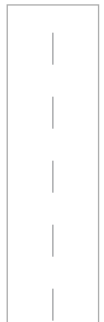
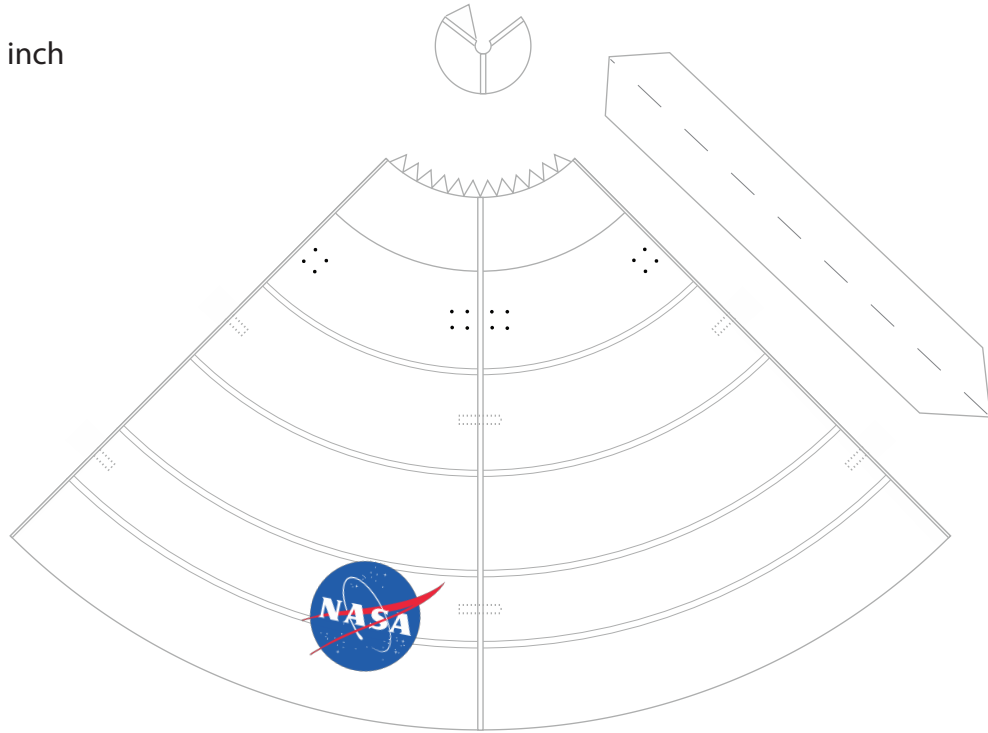



1 cm

1 inch

ATLAS V

Print on Cardstock (110 lb)

1:96 Scale

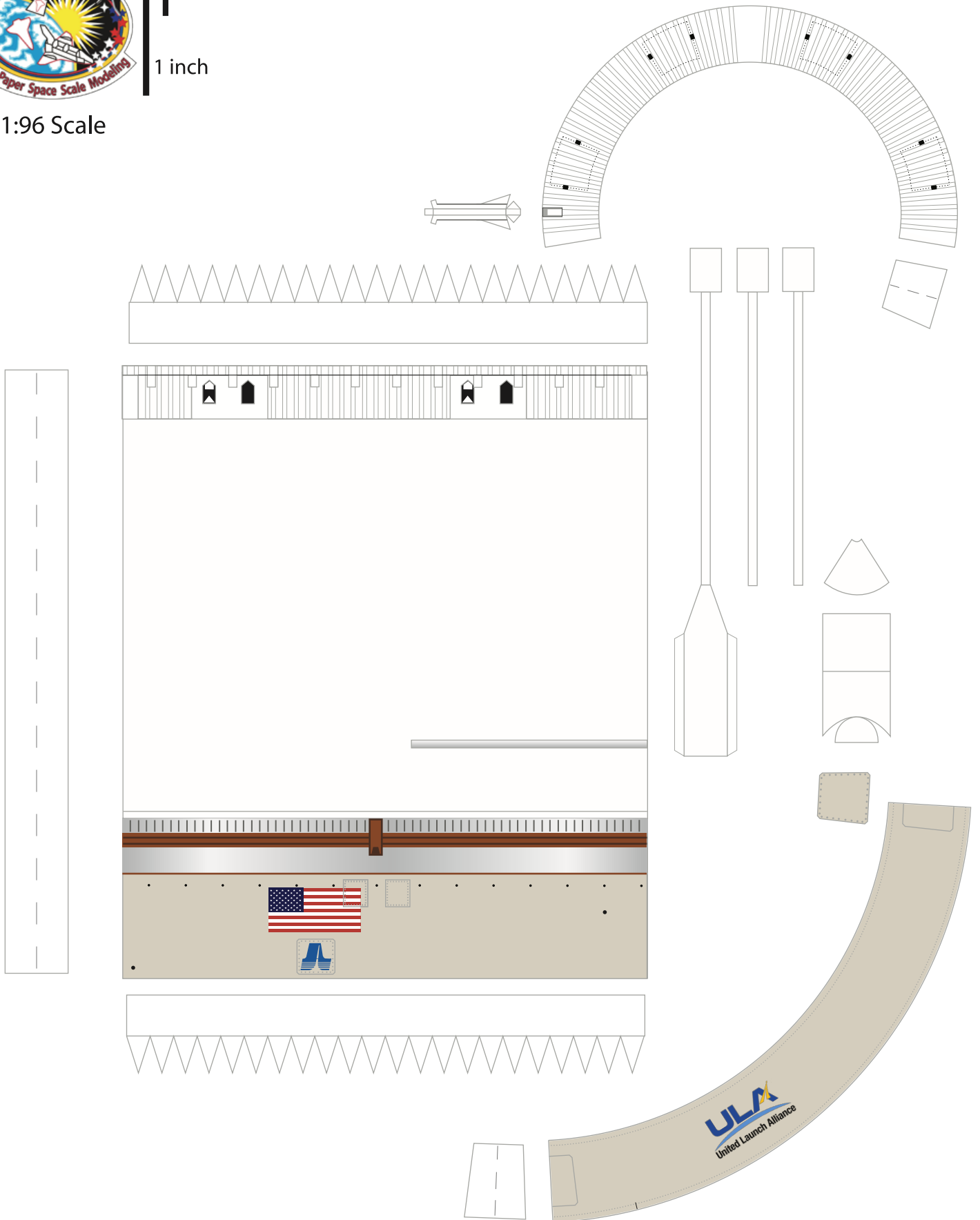



Print on Cardstock (110 lb)

1 cm

ATLAS V Common Core Booster 400 Series

1 inch

1:96 Scale



Common Core Booster

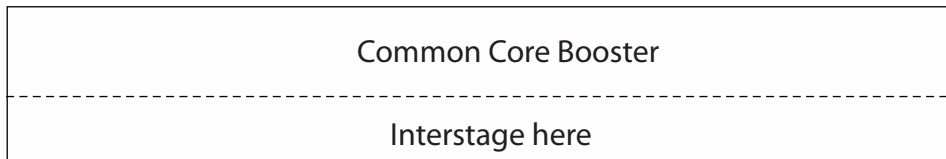
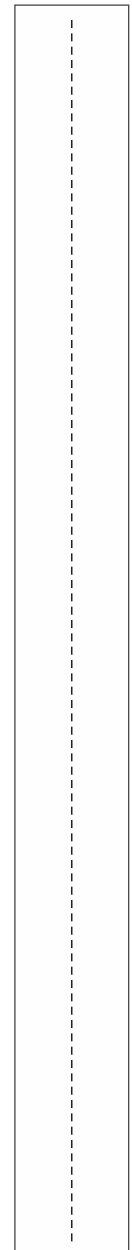
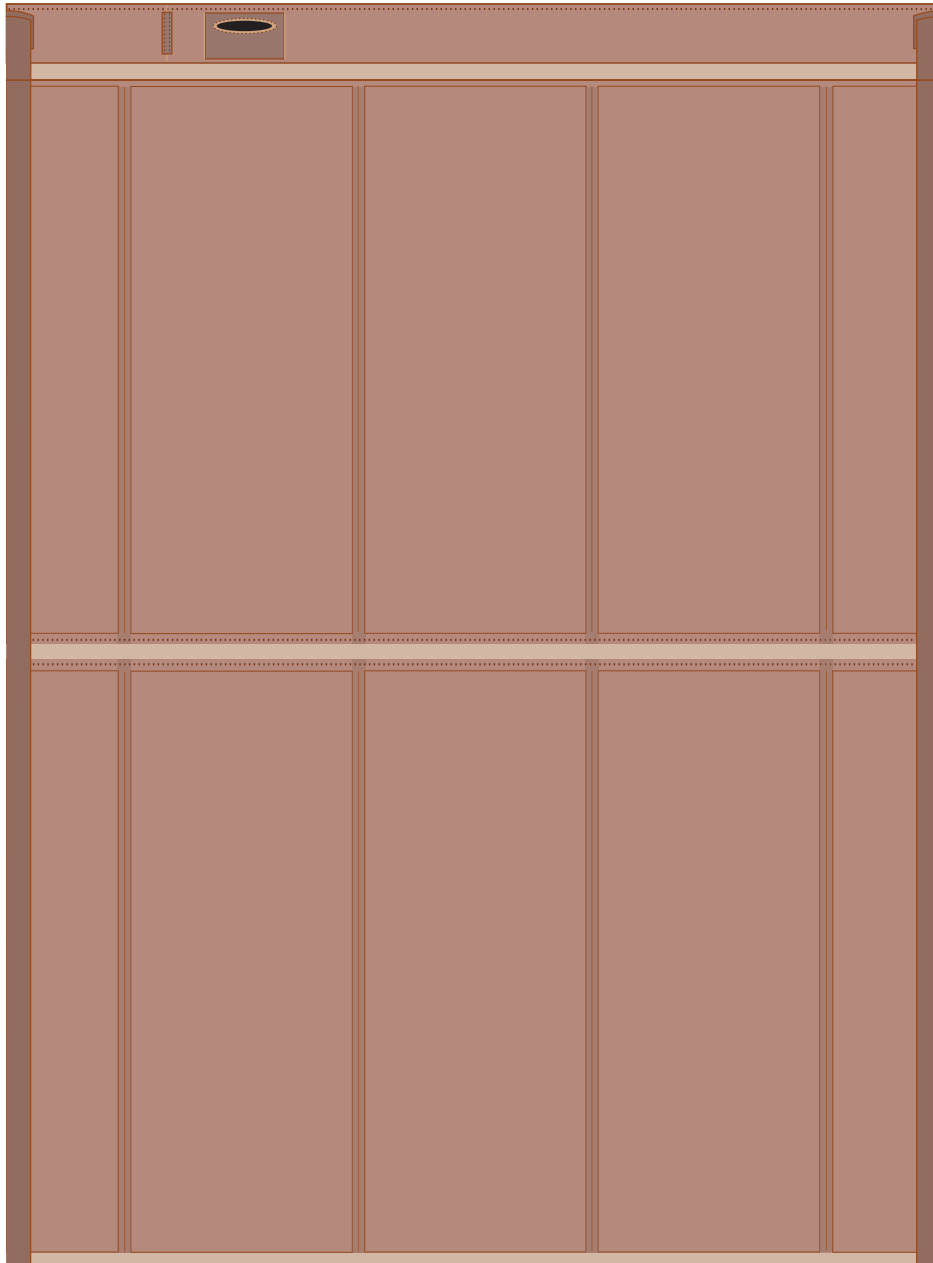



Print on Cardstock (110 lb)

ATLAS V Interstage Section

1:96 Scale



New Version 2016

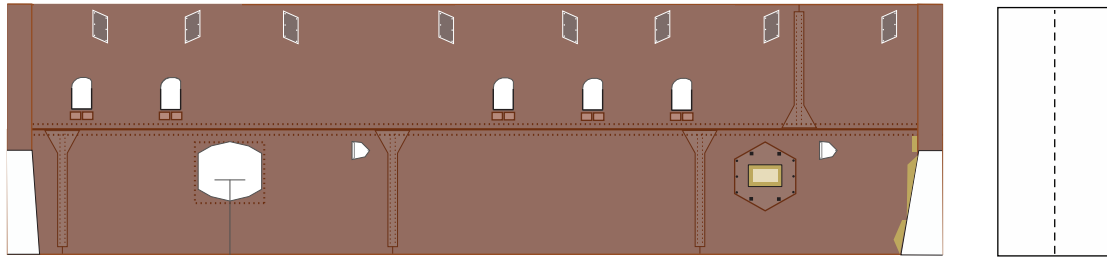

↑
Location of single booster

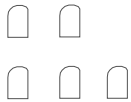

Glue a 2mm x 5 mm rod on the back of each attachment door to cover the openings on the Interstage section if no SRBs are used

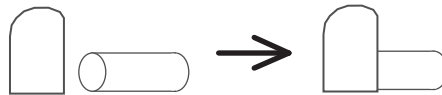



Print on Cardstock (110 lb)

ATLAS V Common Core Booster

Bottom section

1:96 Scale

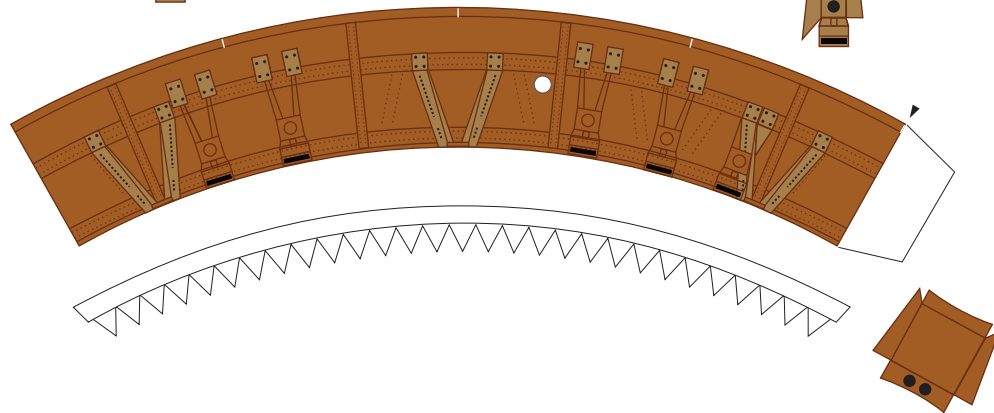
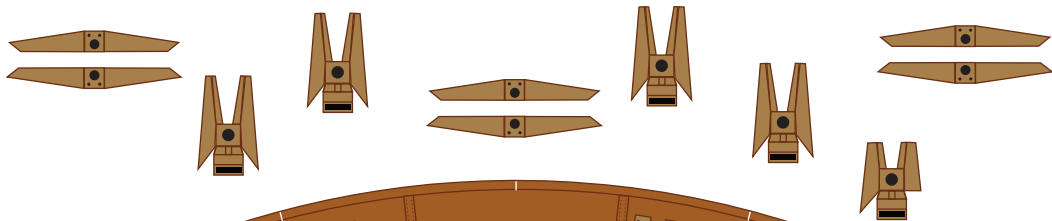
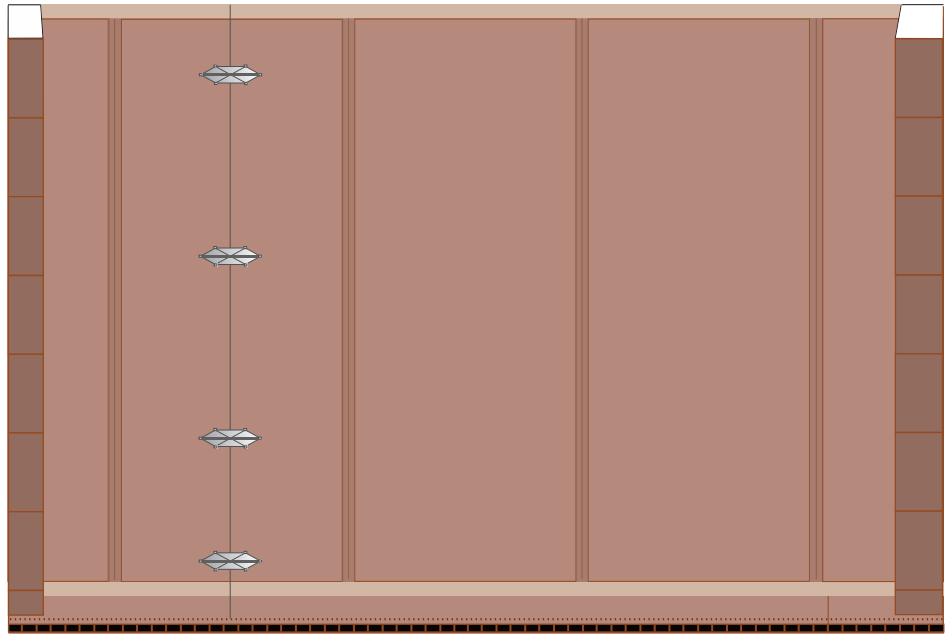
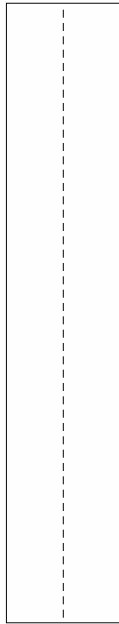
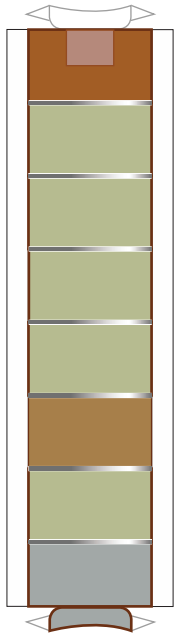
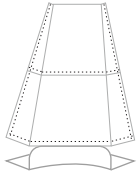



1:96 Scale



Atlas V Fuel line, Cable tray, Engines

Print on Cardstock (110 lb)

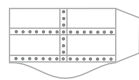
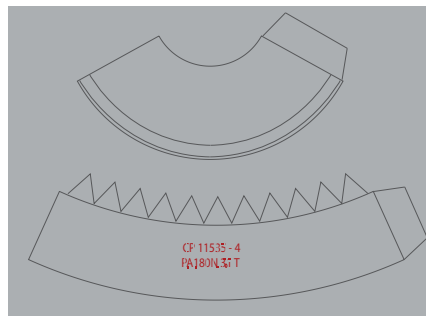
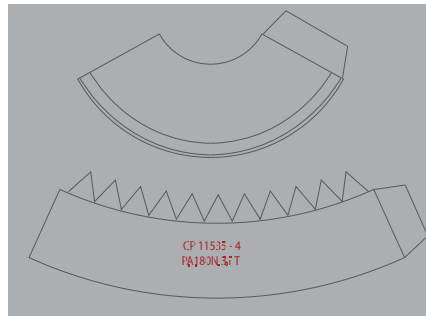
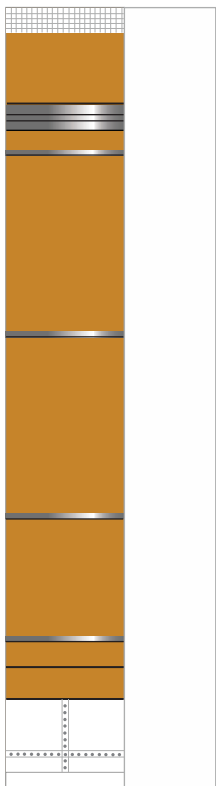
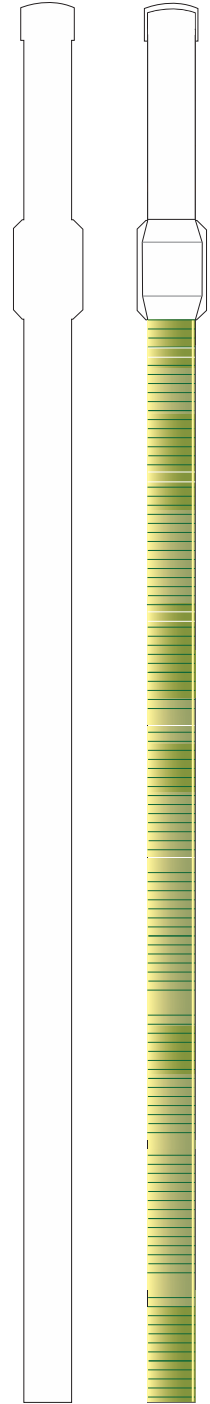
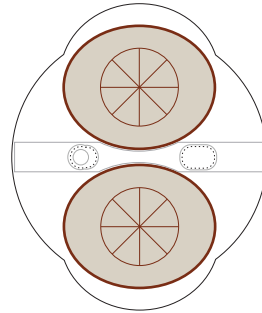
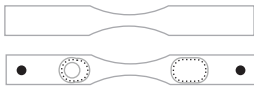
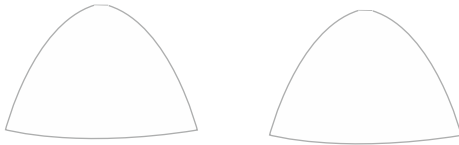
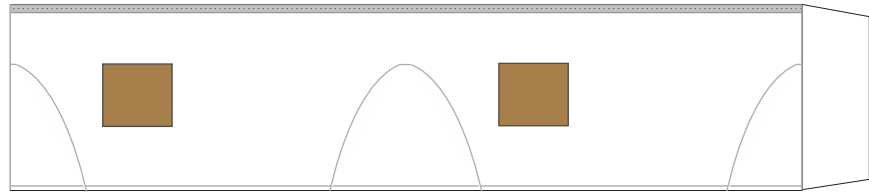



1 cm
1 inch

Print on Cardstock (110 lb)

ATLAS V Solid Rocket Booster

1:96 Scale

Glue rod
(2 mm x 8 mm)

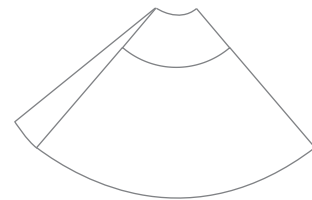
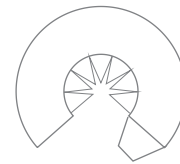
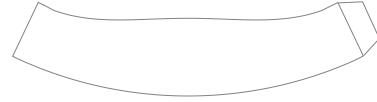
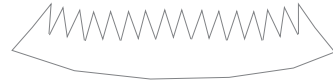
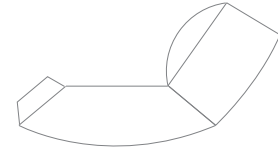
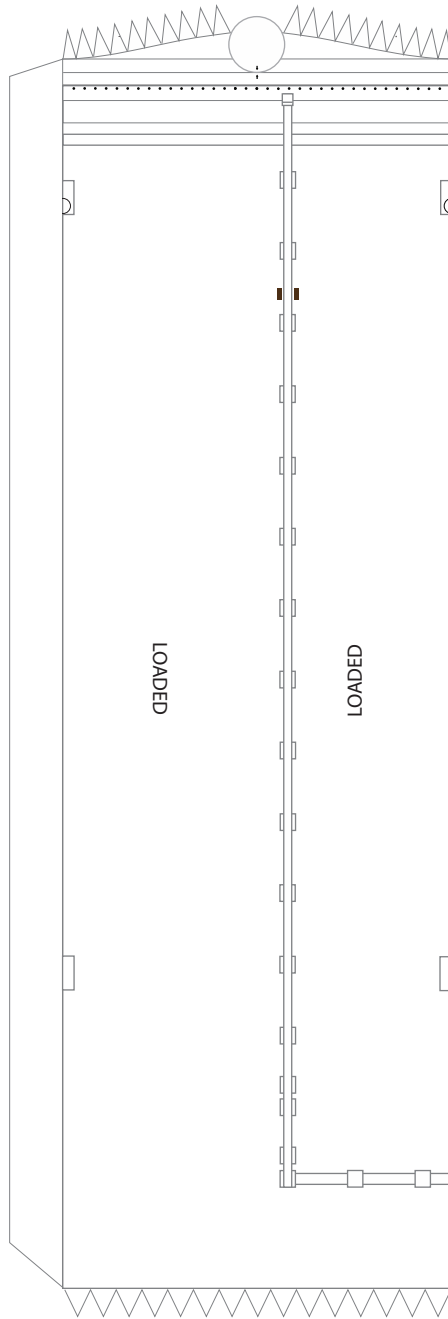
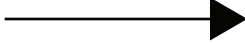

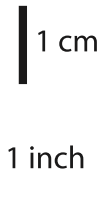

1:96 Scale

ATLAS V Common Core Booster Formers

Print on Cardstock (110 lb)

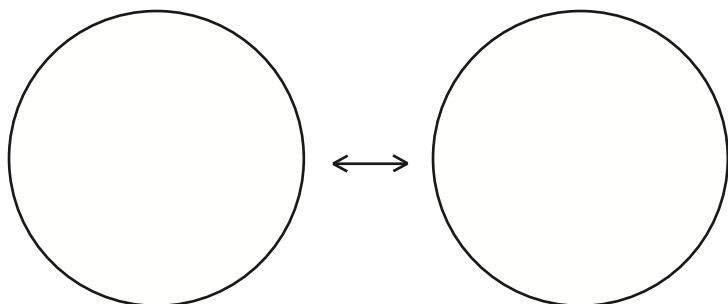
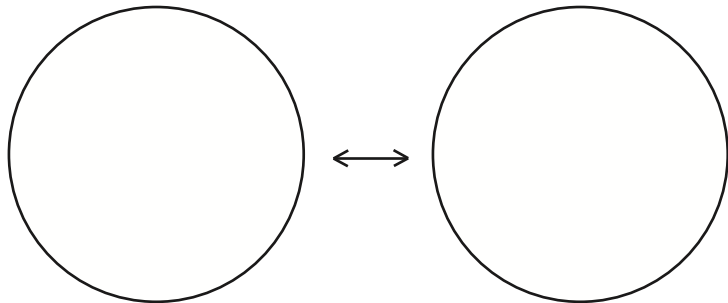
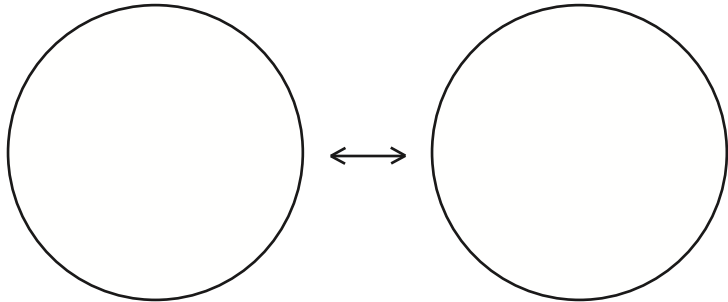
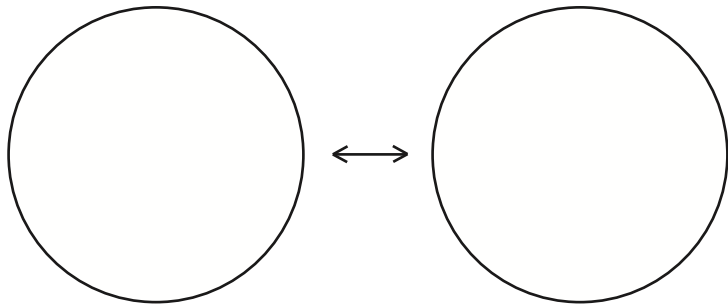
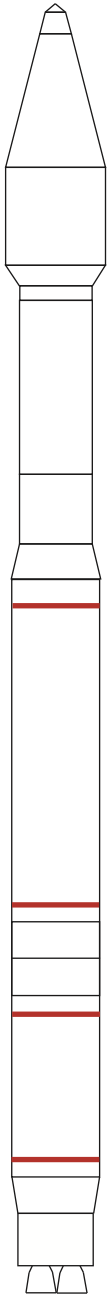



Print on Cardstock (110 lb)

Atlas V Base template

(use foam board and glue stand cones)

1:96 Scale

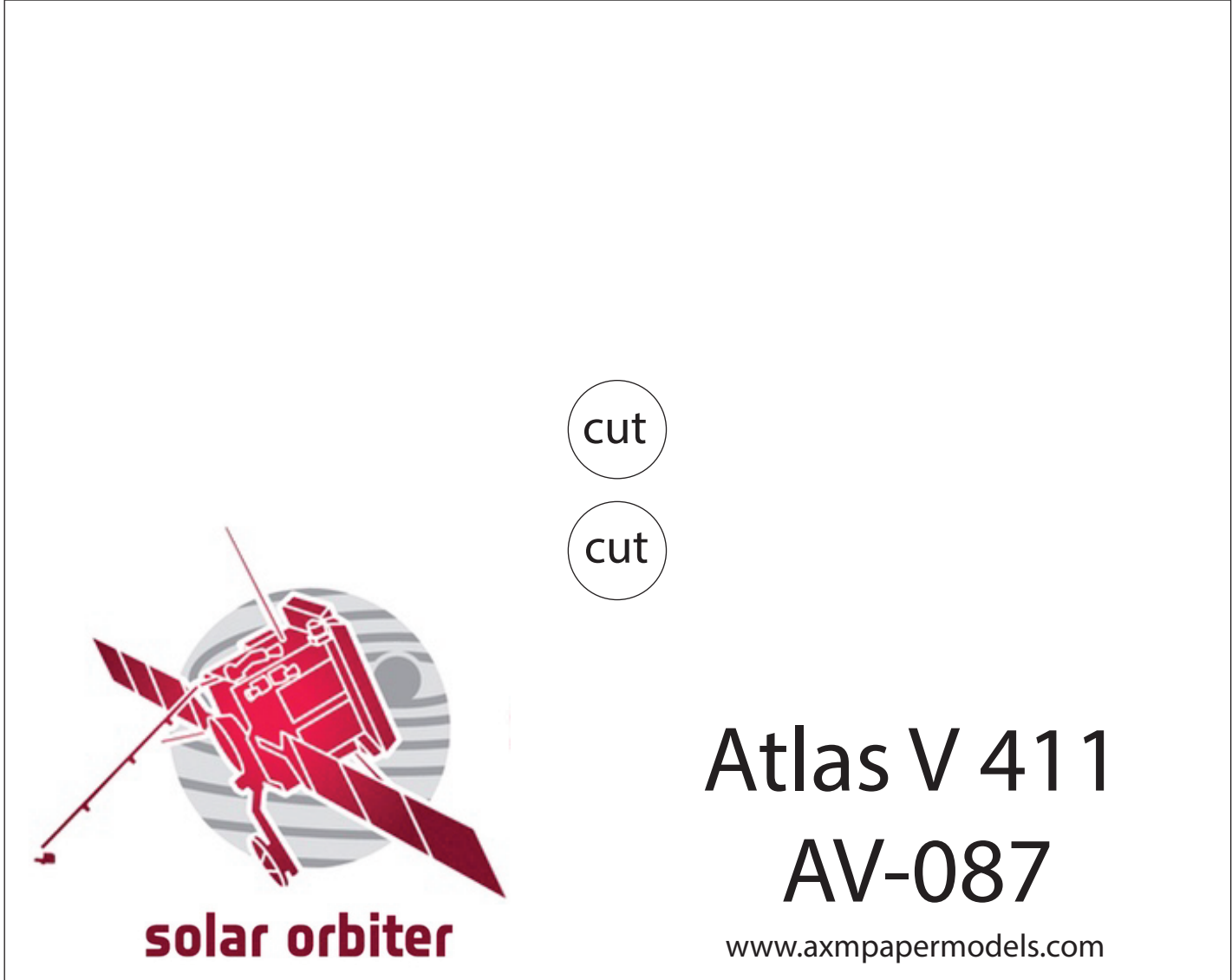

cut

cut

solar orbiter

Atlas V 411

AV-087

www.axmpapermodels.com

