

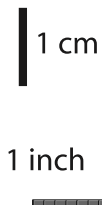

1:96 Scale



ATLAS V Aerodynamic skirt Simple version

Print on Cardstock (110 lb)

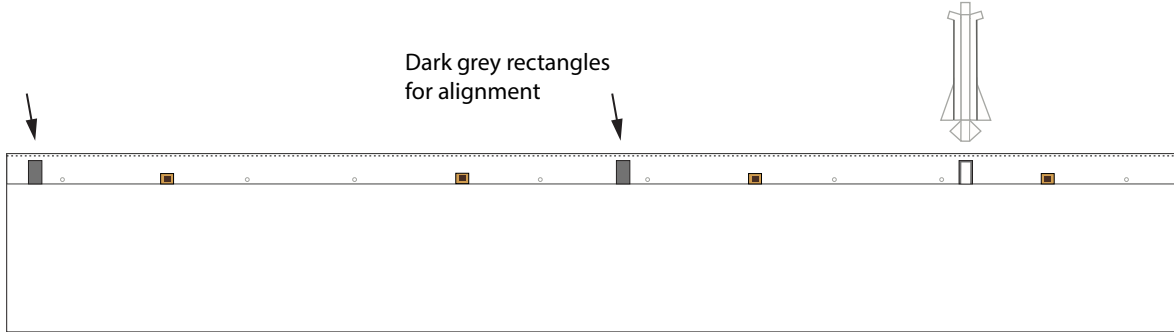

Dark grey rectangles
for alignment

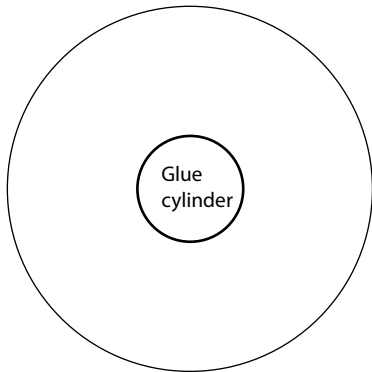
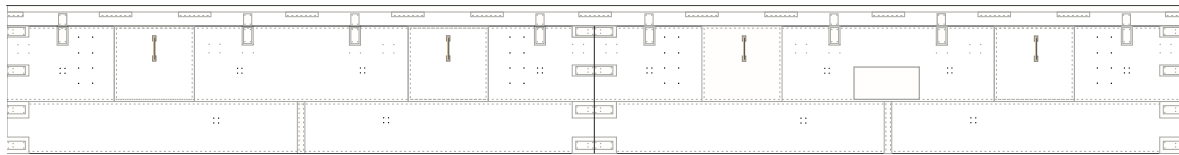

Glue
cylinder

Black square should
be centered
with Centaur fuel line

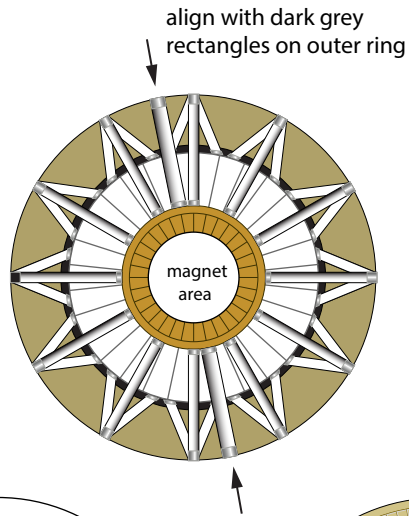

align with dark grey
rectangles on outer ring

magnet
area

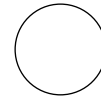

glue on
magnet
area

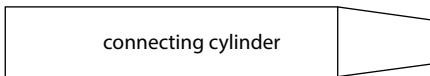
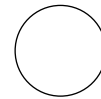

connecting cylinder

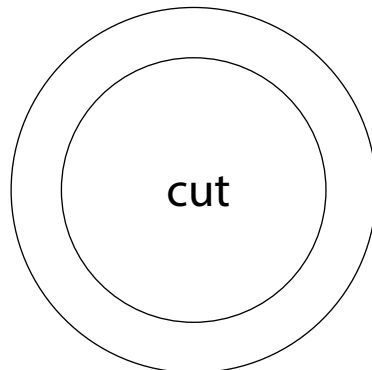

cut

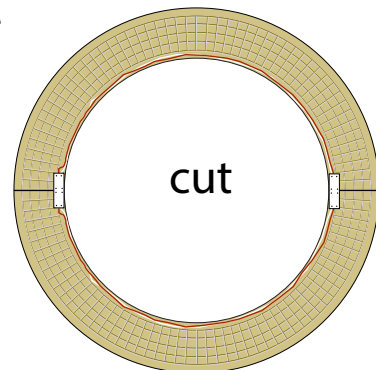

cut



1 cm
1 inch

ATLAS V Aerodynamic skirt Detailed version

Print on Cardstock (110 lb)

1:96 Scale

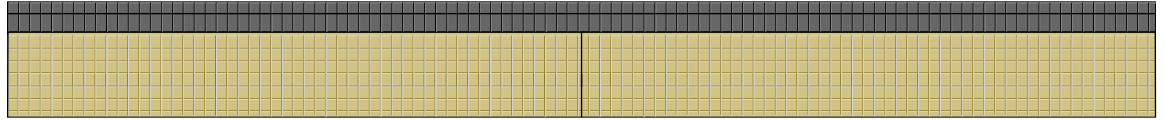

Dark grey rectangles
for alignment

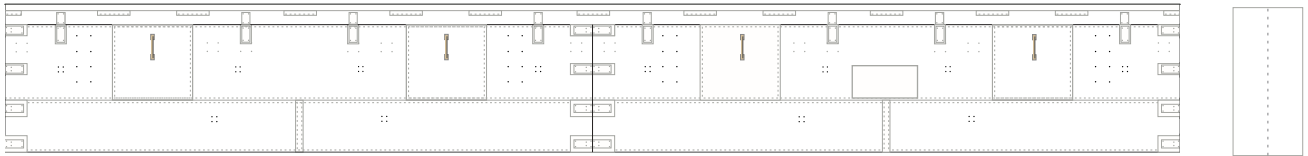

glue on
magnet
area

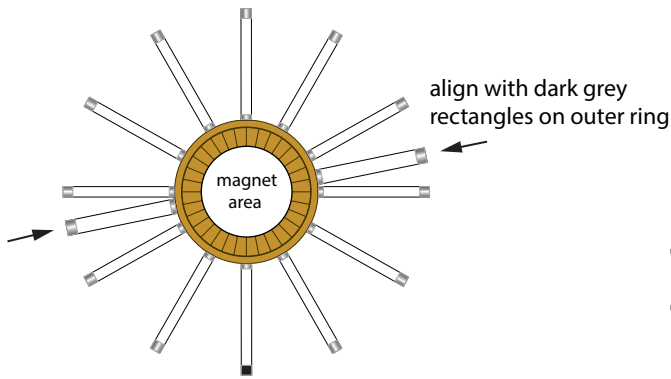
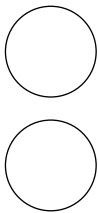

Black square should be centered
with Centaur fuel line

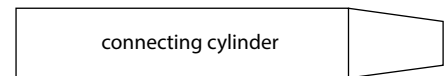
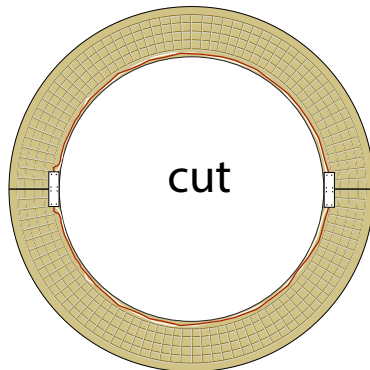
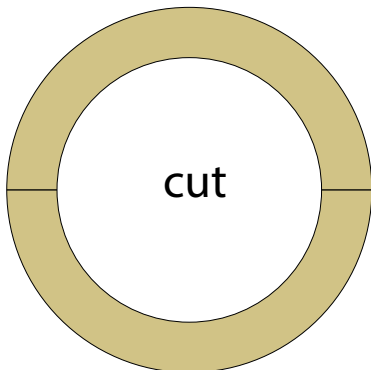
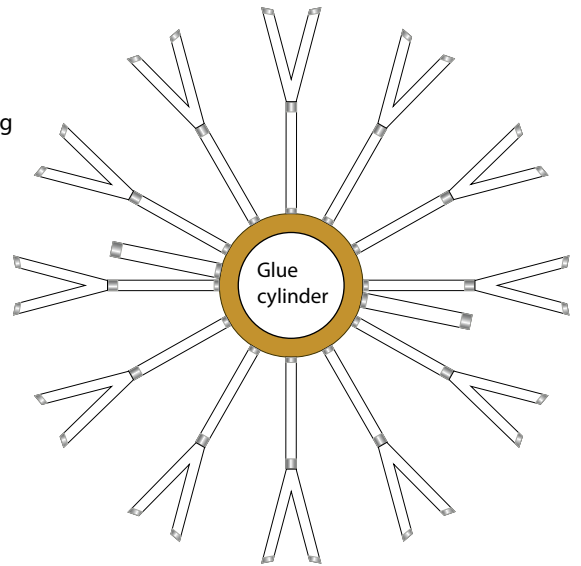

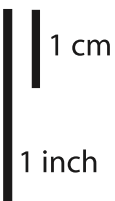

Atlas V Centaur

Print on Cardstock (110 lb)

1:96 Scale

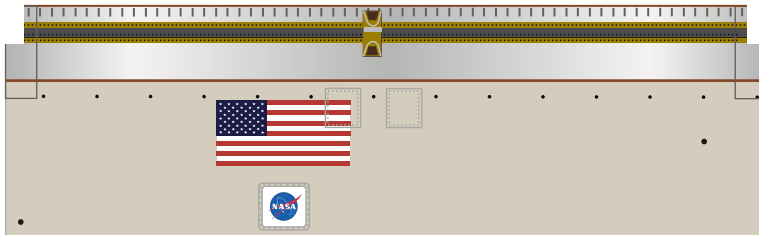
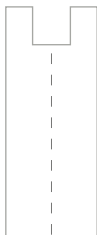
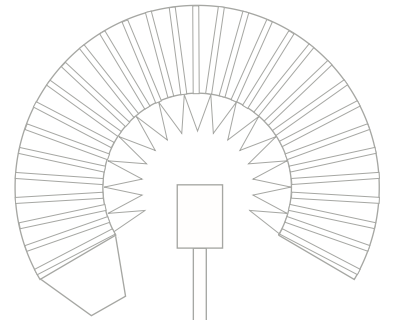
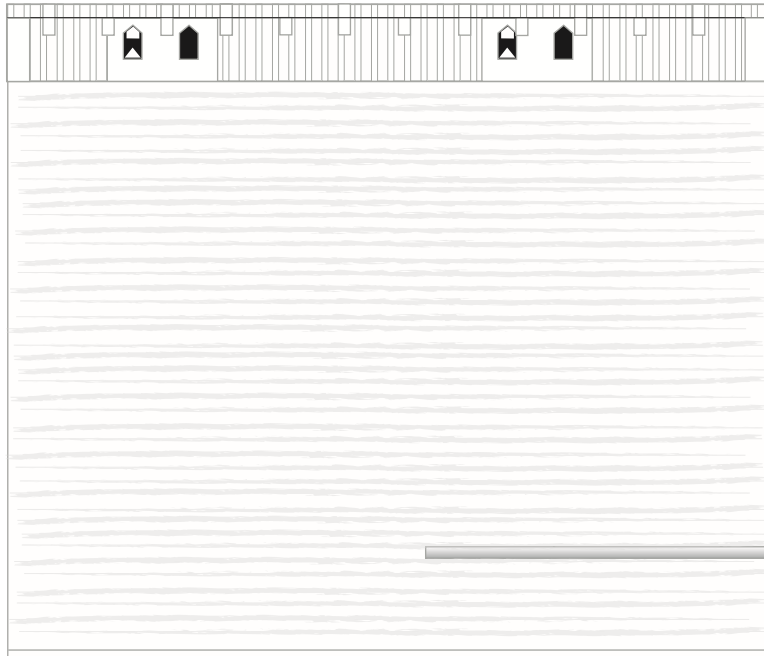
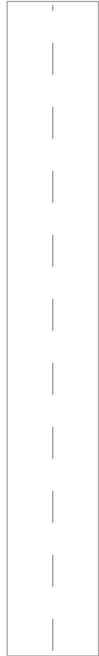
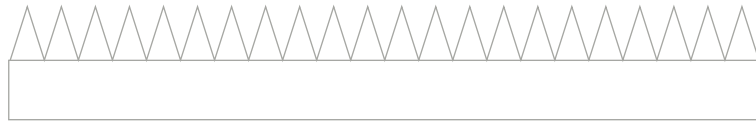

Interstage cone connector

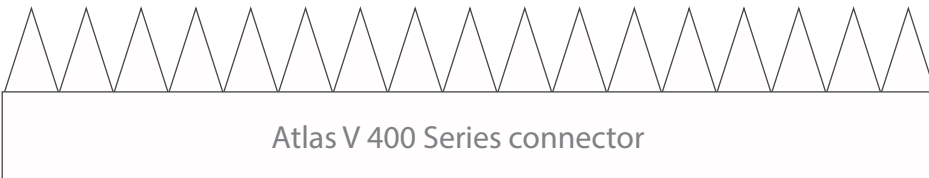

Atlas V 400 Series connector

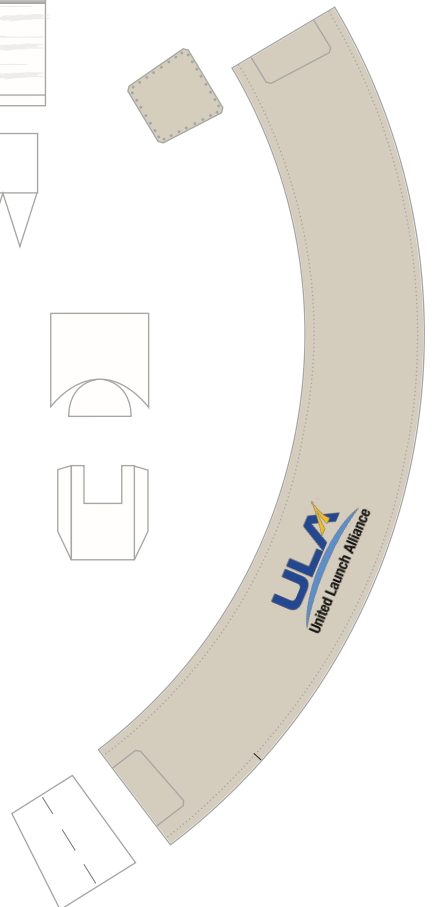



1 cm
1 inch

ATLAS V

Print on Cardstock (110 lb)

Centaur Aft Bulkhead section

1:96 Scale

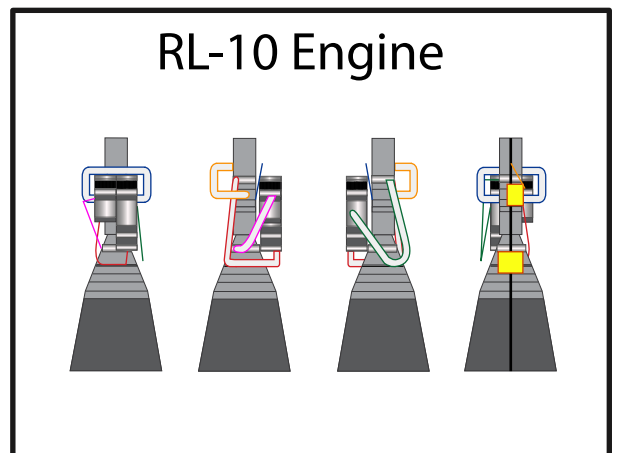
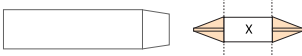
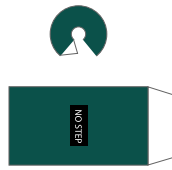
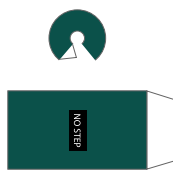
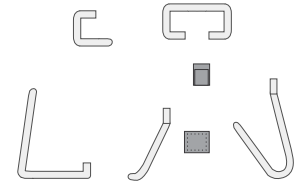
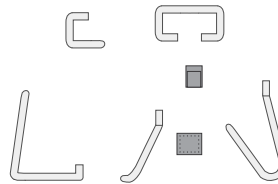
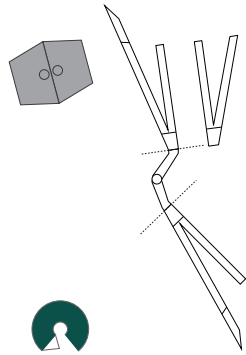
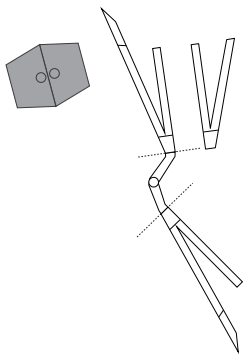
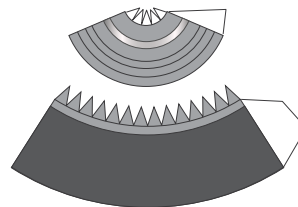
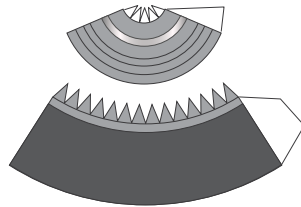
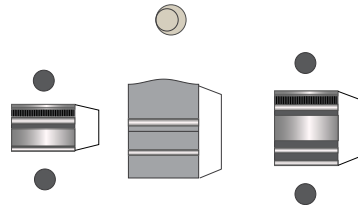
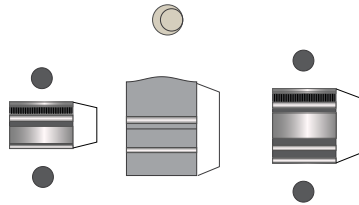
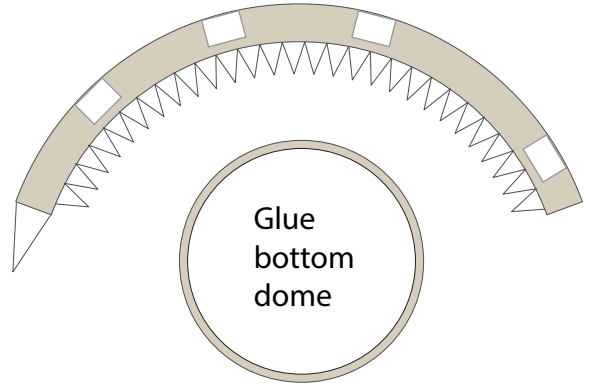
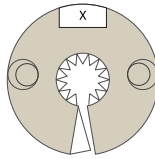
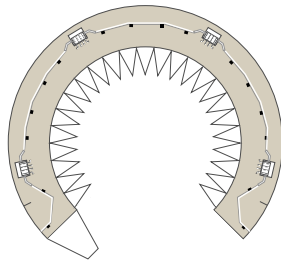
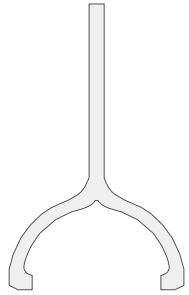

Centaur Aft Bulkhead section

Back Print page





Print on Cardstock (110 lb)

1 cm

ATLAS V Common Core Booster 400 Series

1 inch

1:96 Scale



Common Core Booster

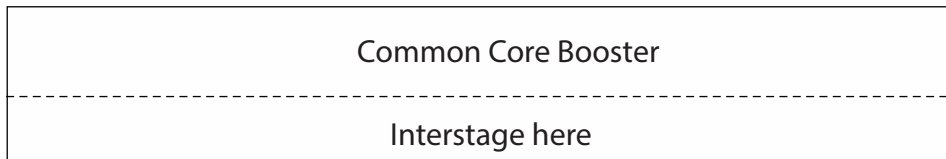
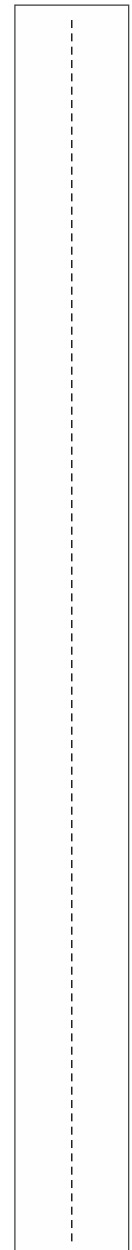
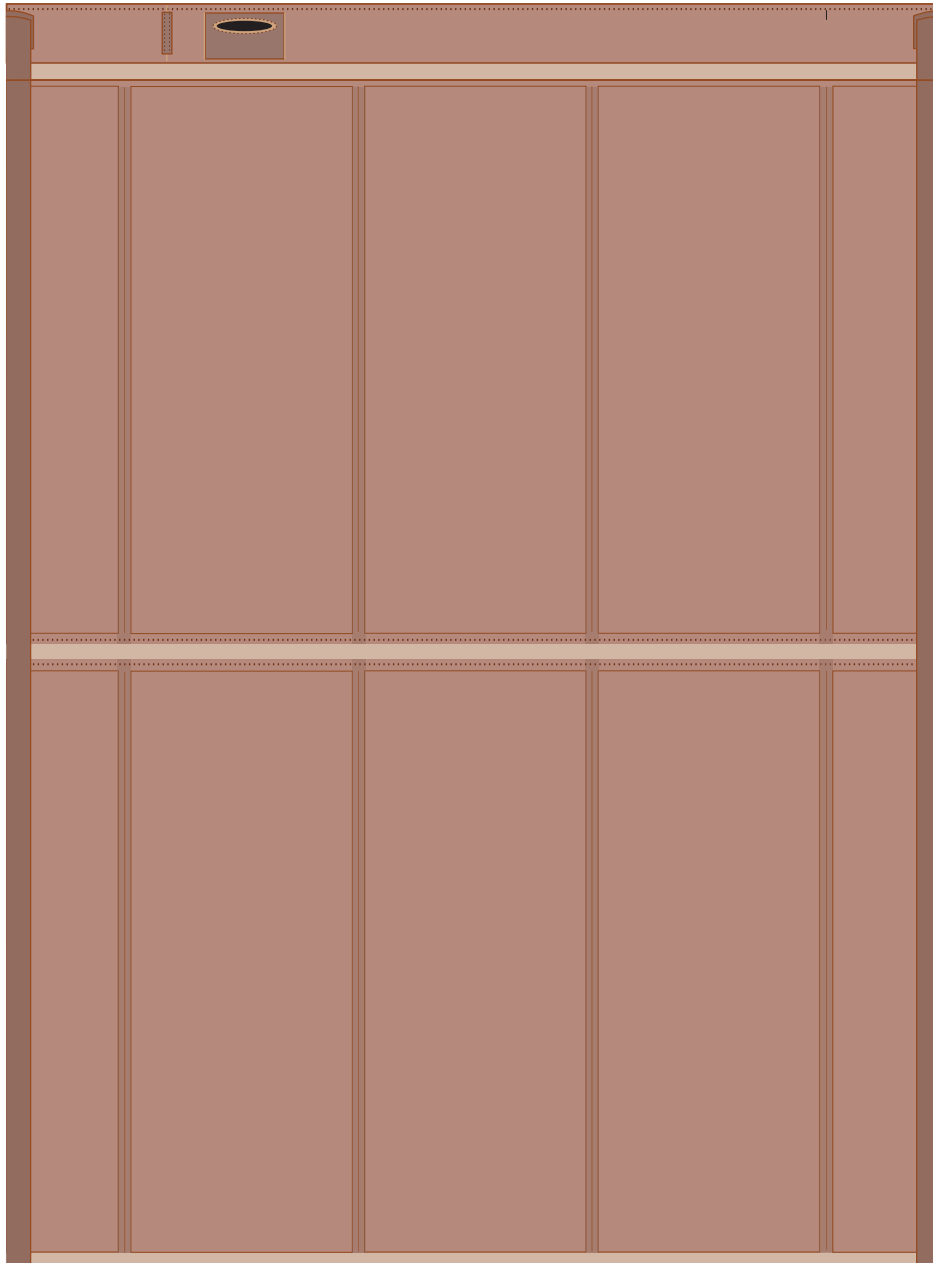



STARLINER N22

ATLAS V Interstage Section

Print on Cardstock (110 lb)

1:96 Scale



New Version 2016

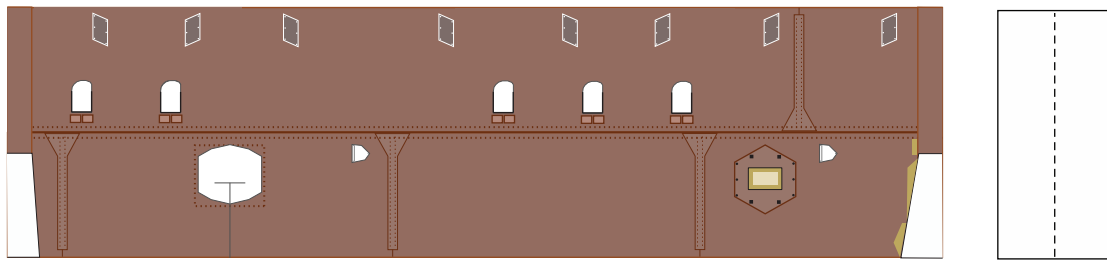

↑
Location of booster

↑
Location of booster

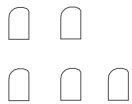

Glue a 2mm x 5 mm rod on the back of each attachment door to cover the openings on the Interstage section if no SRBs are used

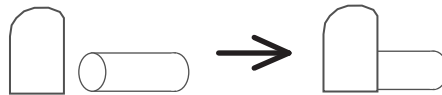



Print on Cardstock (110 lb)

ATLAS V Common Core Booster

Bottom section

1:96 Scale

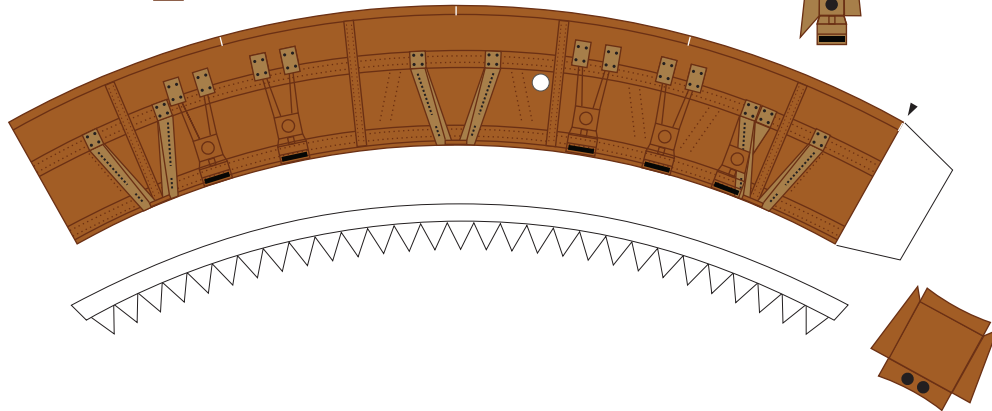
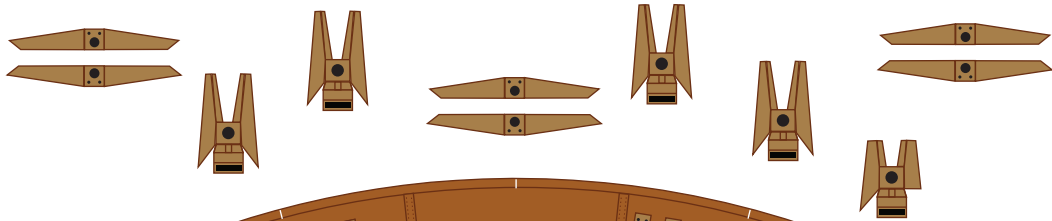
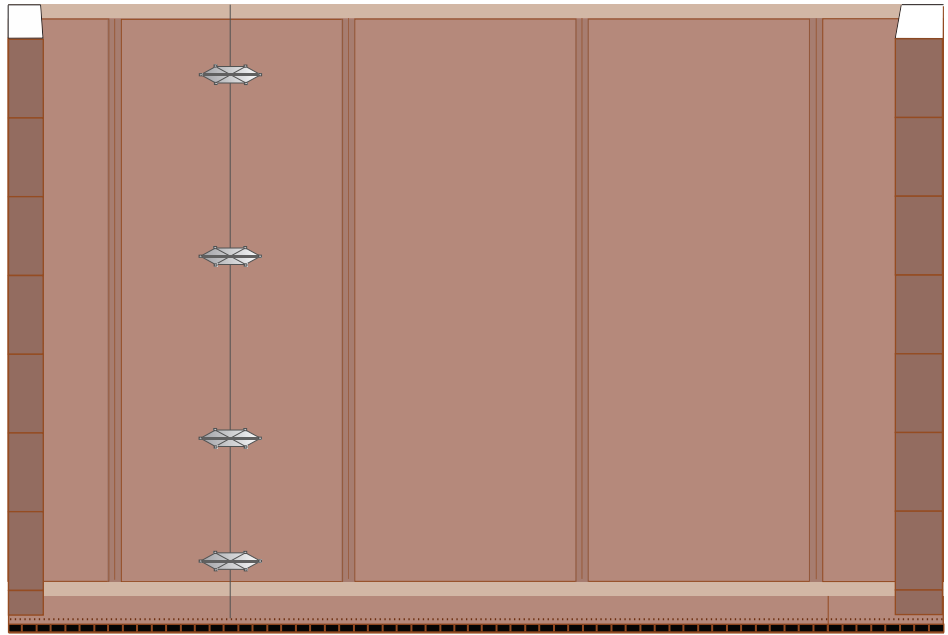
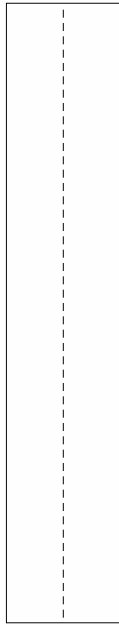
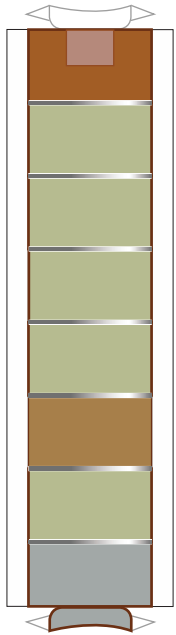
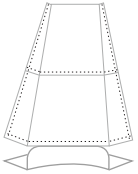



1:96 Scale



Atlas V Fuel line, Cable tray, Engines

Print on Cardstock (110 lb)

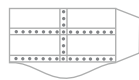
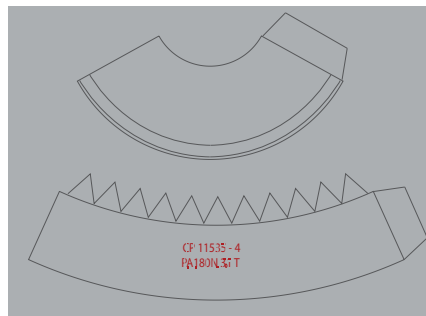
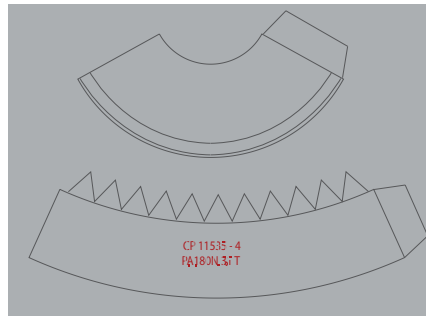
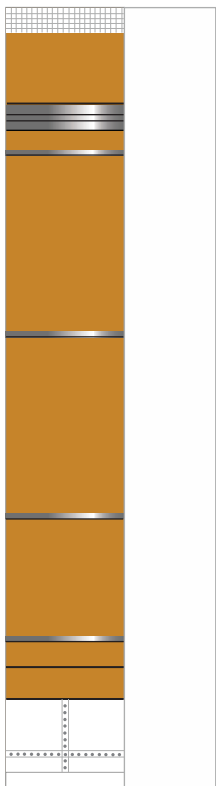
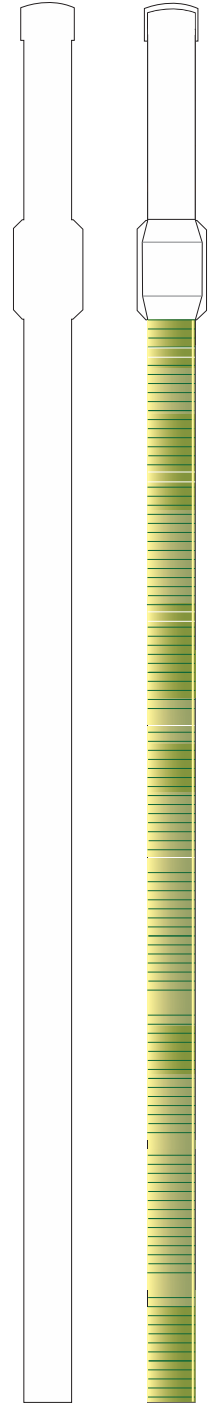
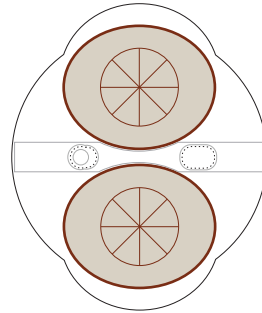
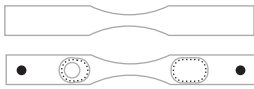
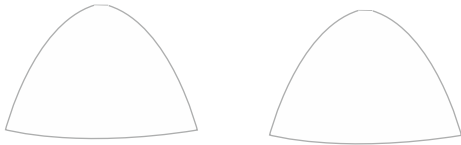
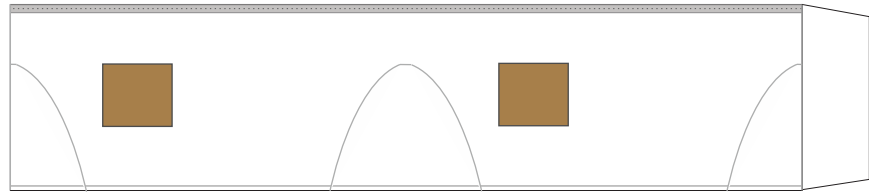



1 cm
1 inch

Print on Cardstock (110 lb)

ATLAS V Solid Rocket Booster

1:96 Scale

Glue rod
(2 mm x 8 mm)

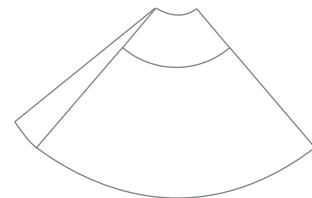
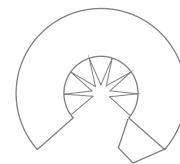
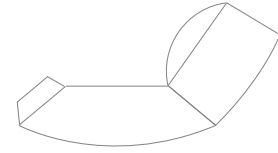
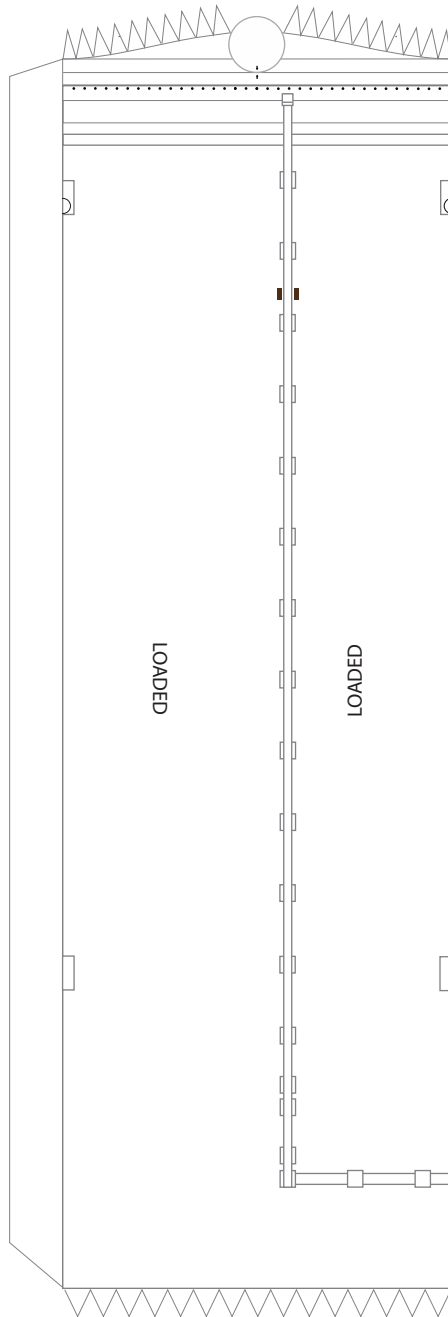
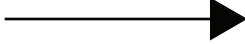



1 cm
1 inch

Print on Cardstock (110 lb)

ATLAS V Solid Rocket Booster

1:96 Scale

Glue rod
(2 mm x 8 mm)

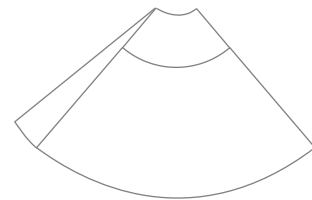
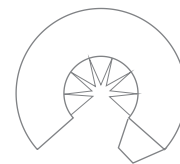
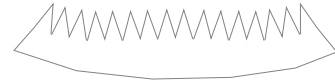
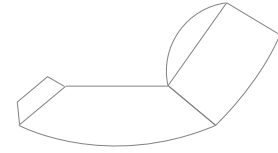
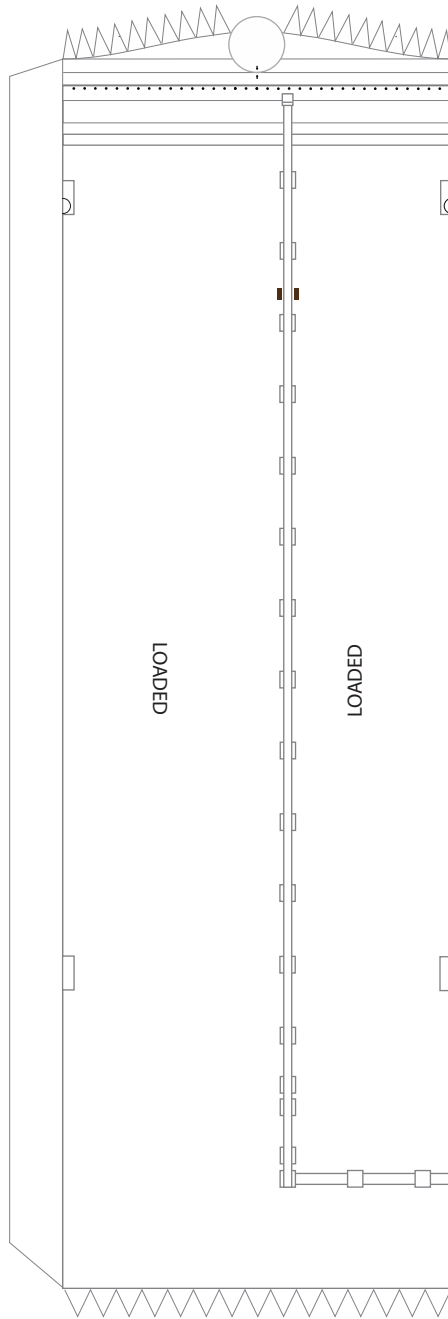
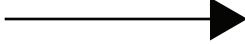



ATLAS V Common Core Booster Formers

Print on Cardstock (110 lb)

1:96 Scale

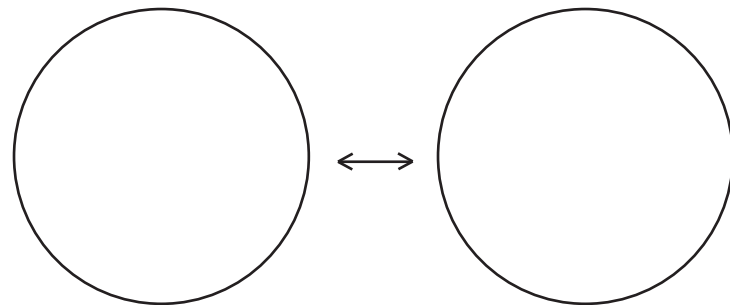
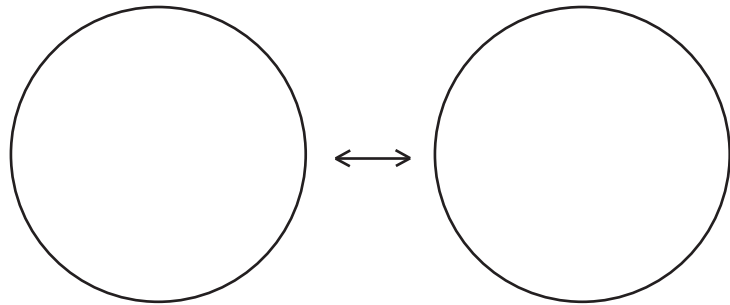
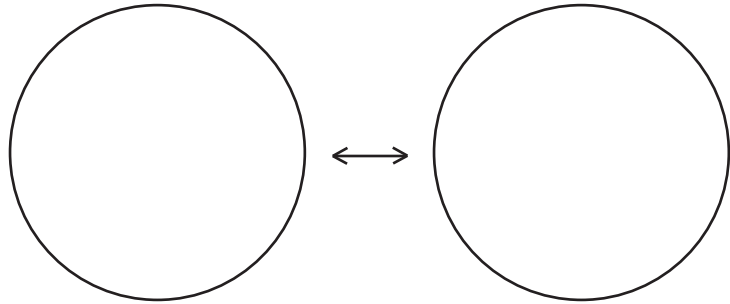
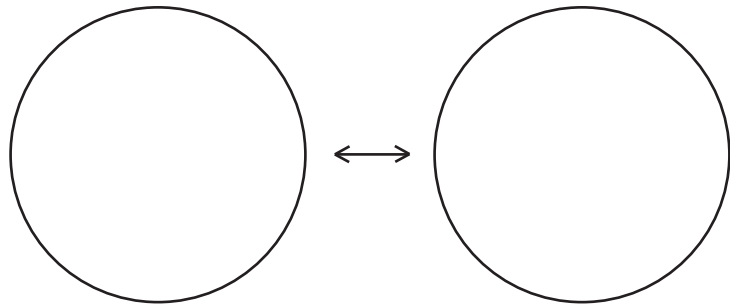
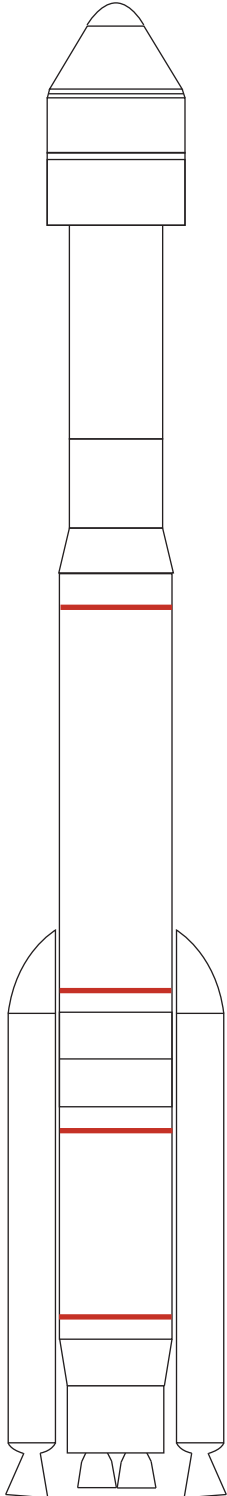



Print on Cardstock (110 lb)

Atlas V Base template

(use foam board and glue stand cones)

1:96 Scale

cut

cut



ATLAS V - N22 STARLINER OFT-1

www.axmpapermodels.com

