

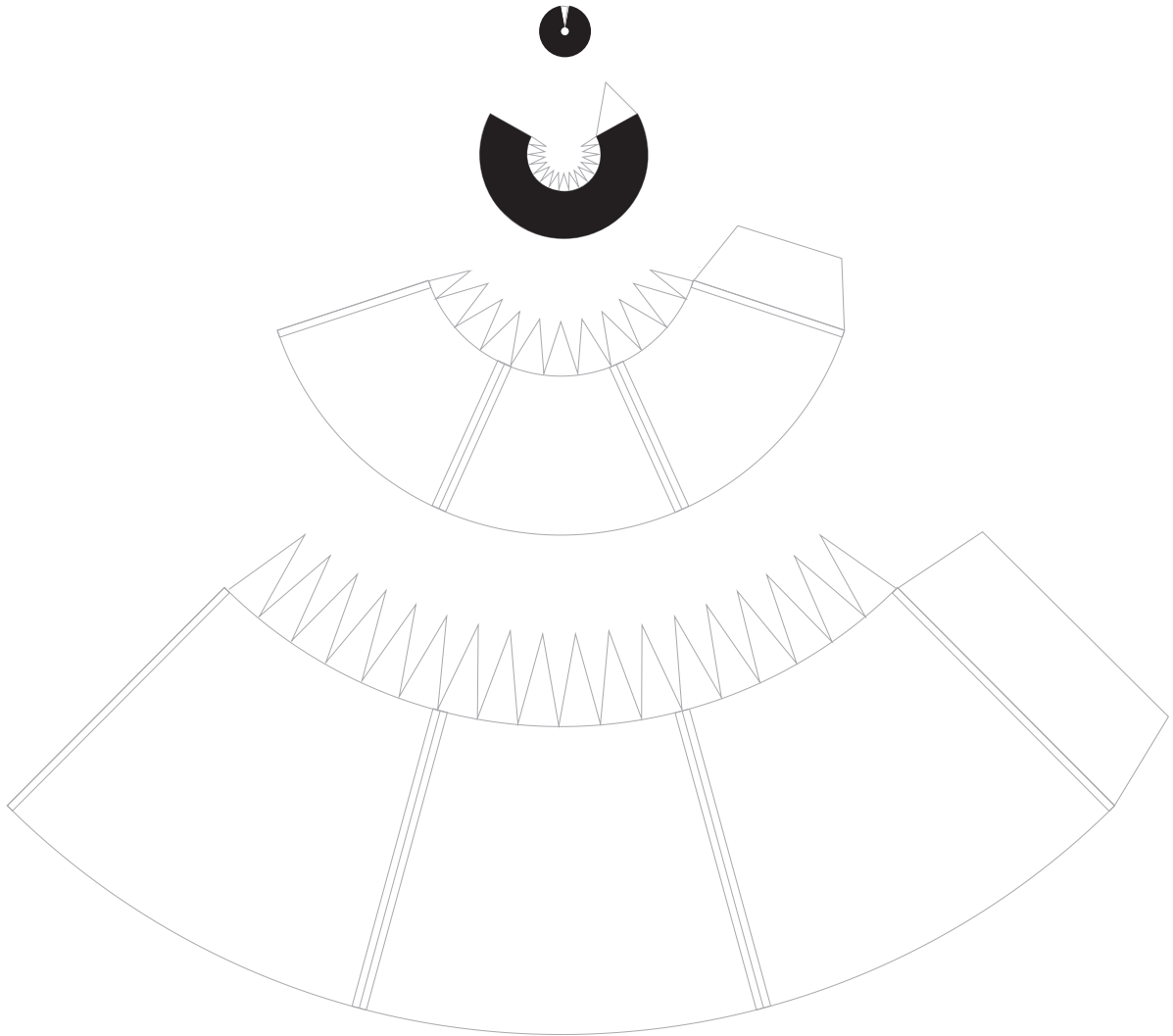

Print on Cardstock (110 lbs)

Delta IV Nosecone Long Trisector Fairing

1:96 Scale





Delta IV Heavy

Print on Cardstock (110 lbs)

NROL-44 Payload
Long Trisector Fairing

1:96 Scale

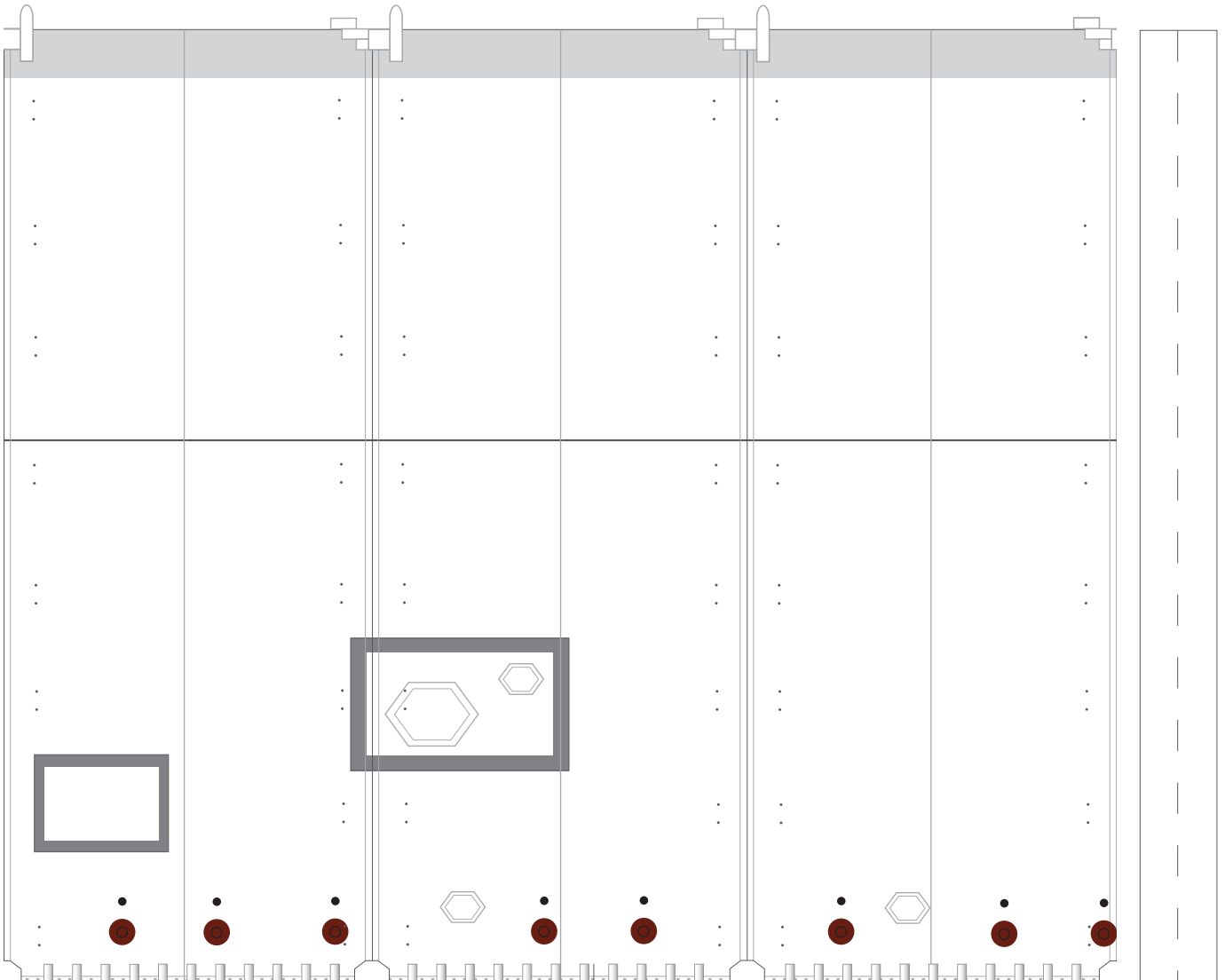



NROL-44 Insterstage

Print on Cardstock (110 lbs)

1:96 Scale

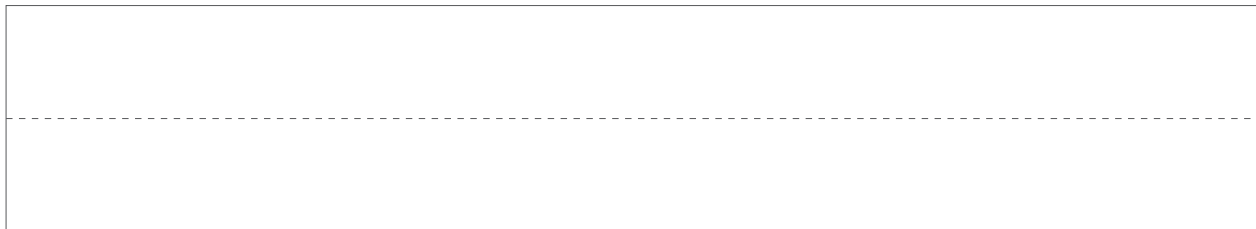
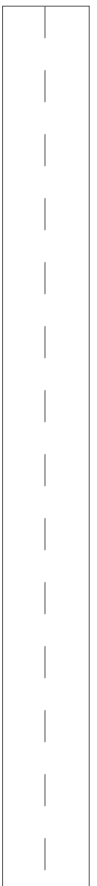
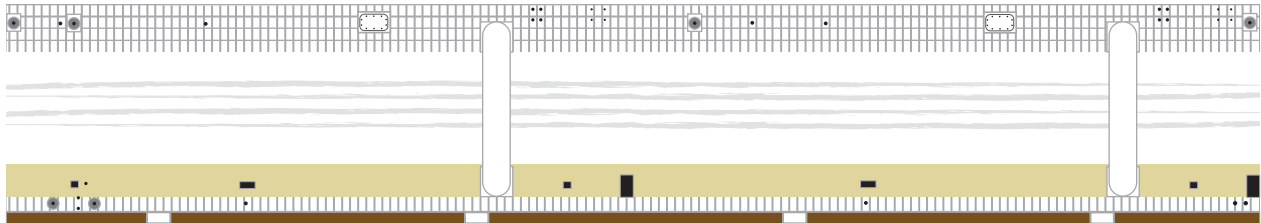
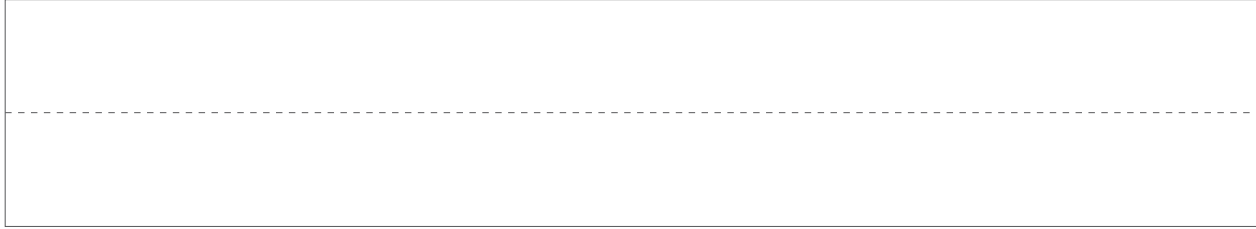



NROL-44

Print on Cardstock (110 lbs)

Delta IV Common Booster Core Center

1:96 Scale

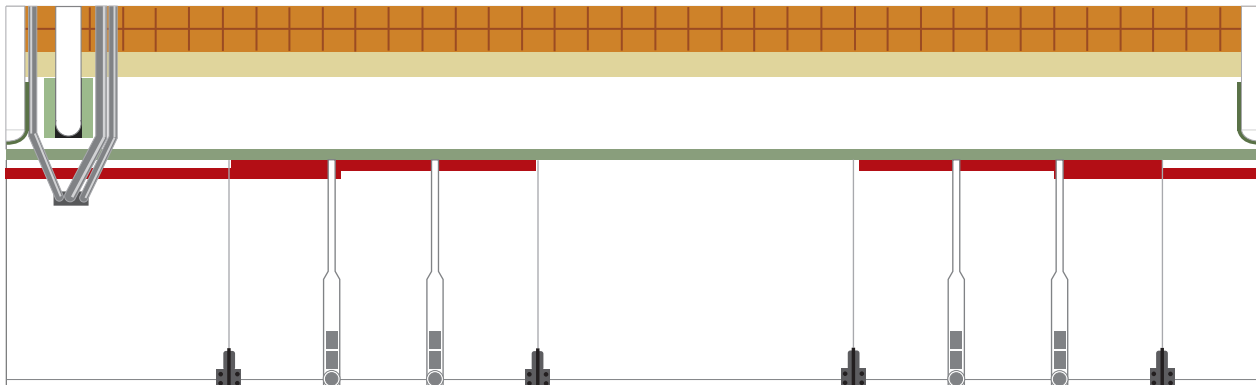
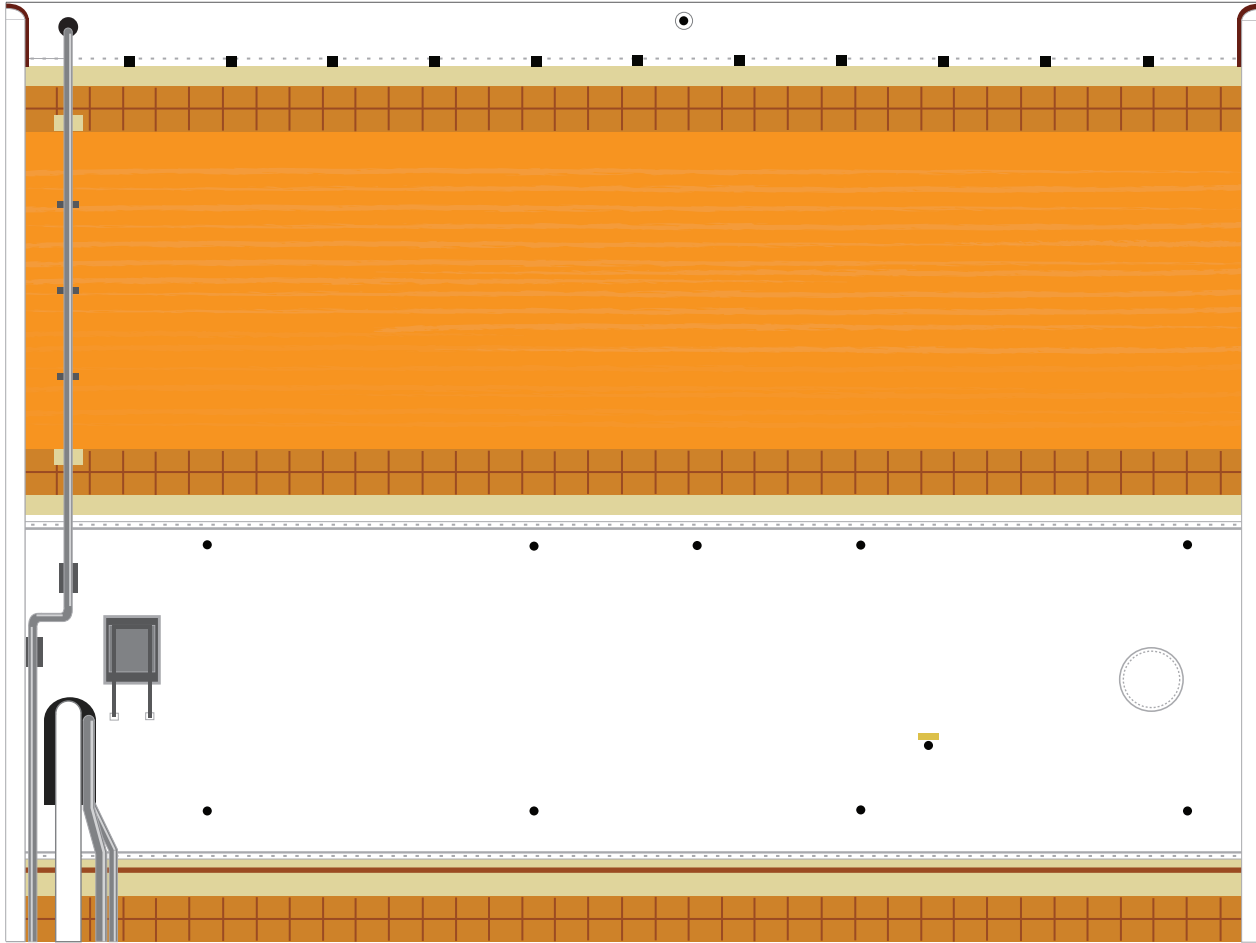



Center Delta IV Common Booster Core

Print on Cardstock (110 lbs)

1:96 Scale

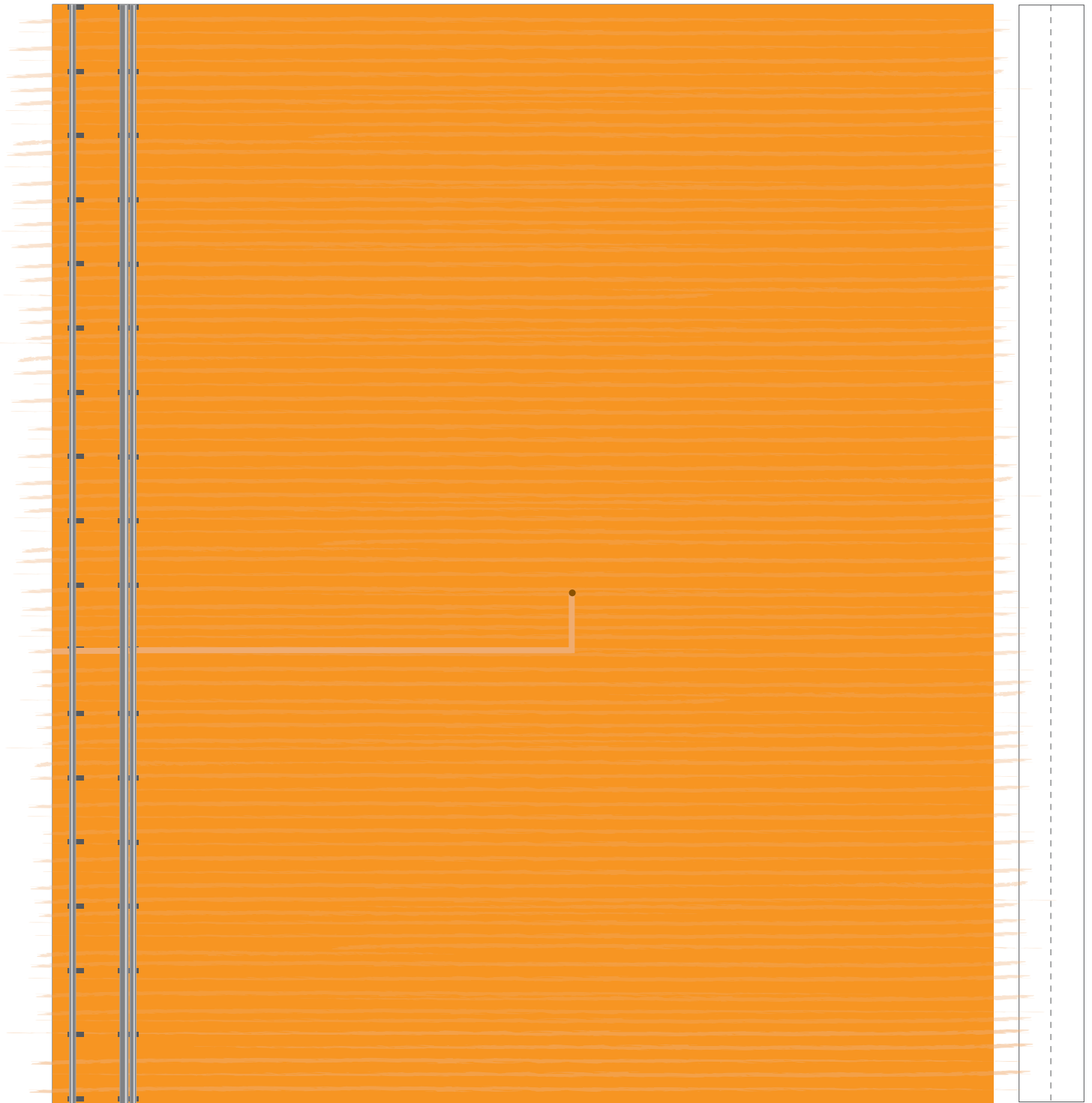



1 cm
1 inch

NROL-44

Print on Cardstock (110 lbs)

Delta IV Common Booster Core Left

1:96 Scale

Align nosecone seam

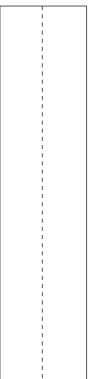
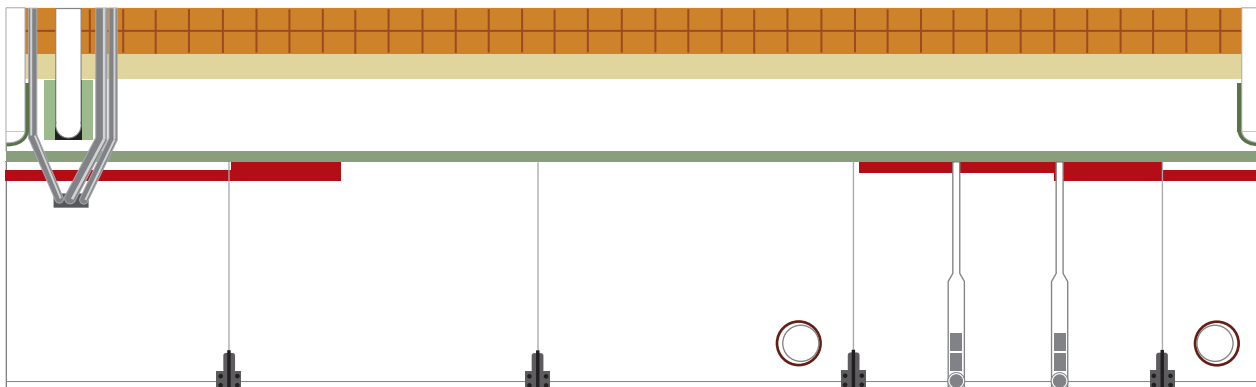
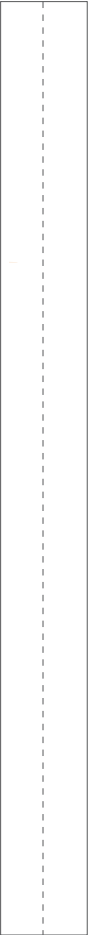
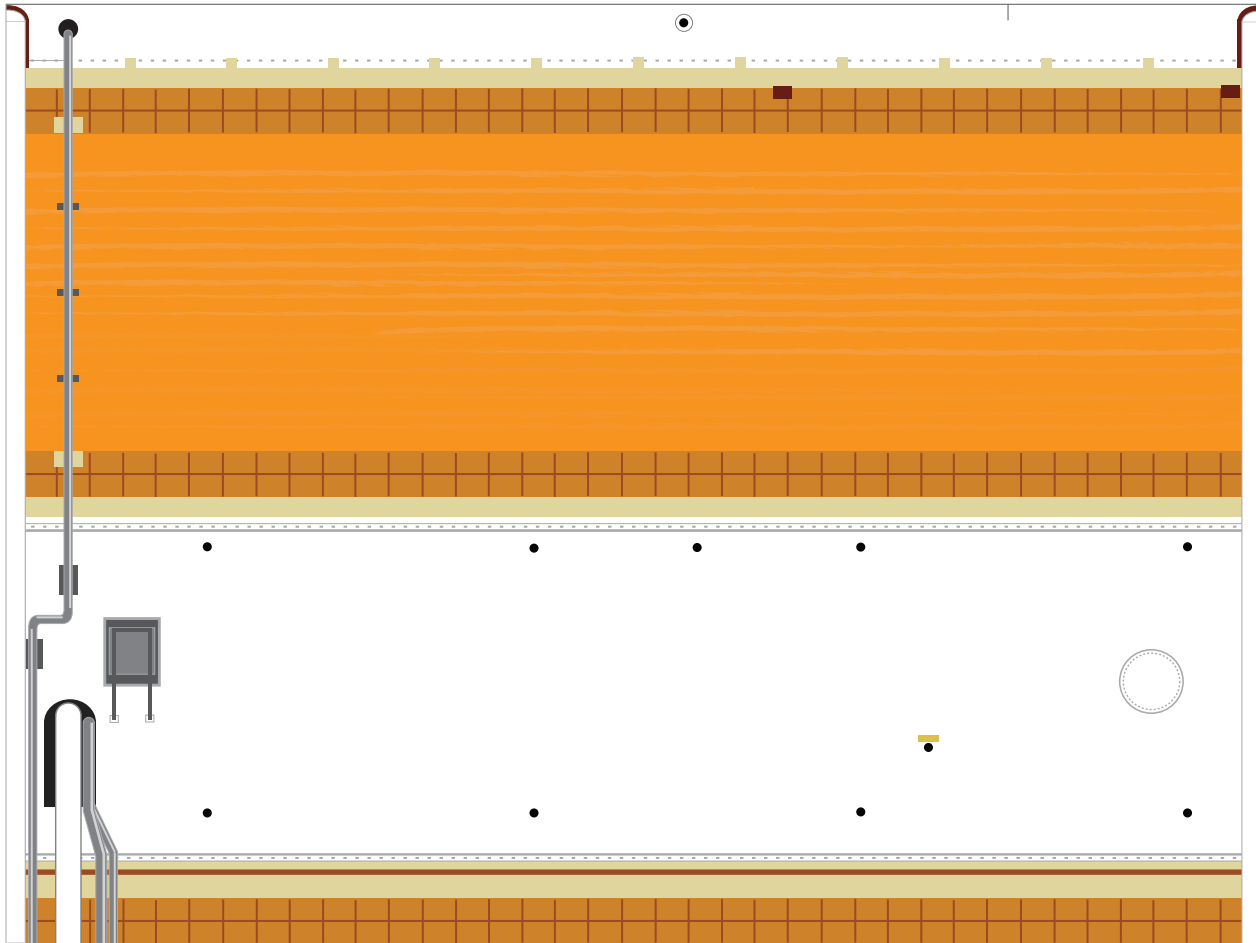



Left Delta IV Common Booster Core

Print on Cardstock (110 lbs)

1:96 Scale

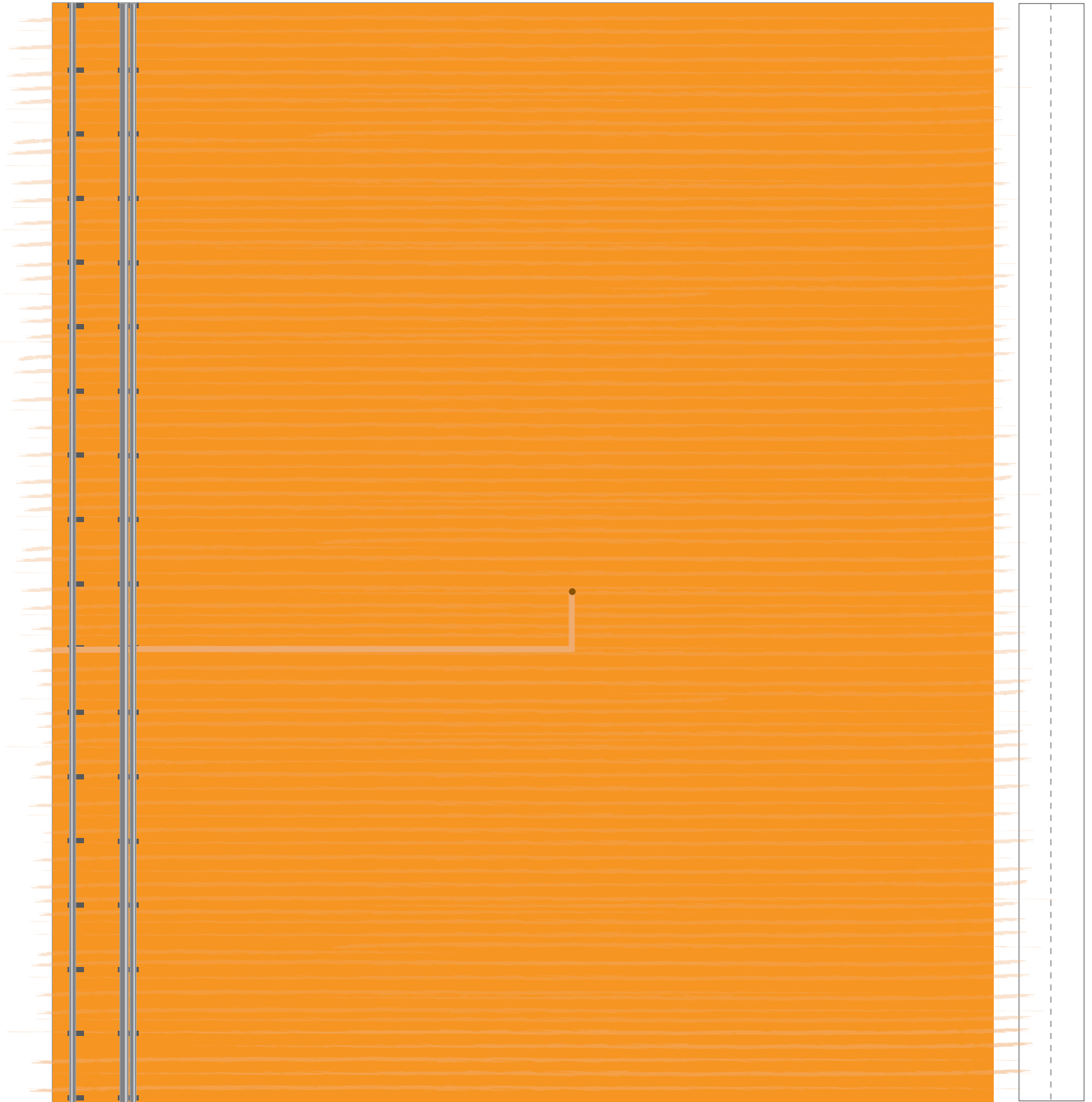

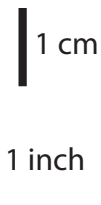

NROL-44

Print on Cardstock (110 lbs)

Delta IV Common Booster Core Right

1:96 Scale

Align nosecone seam
↓

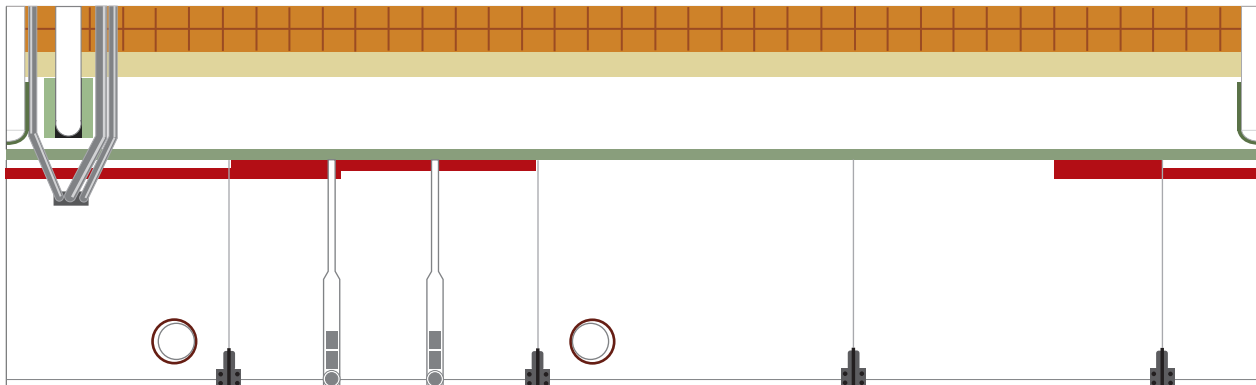
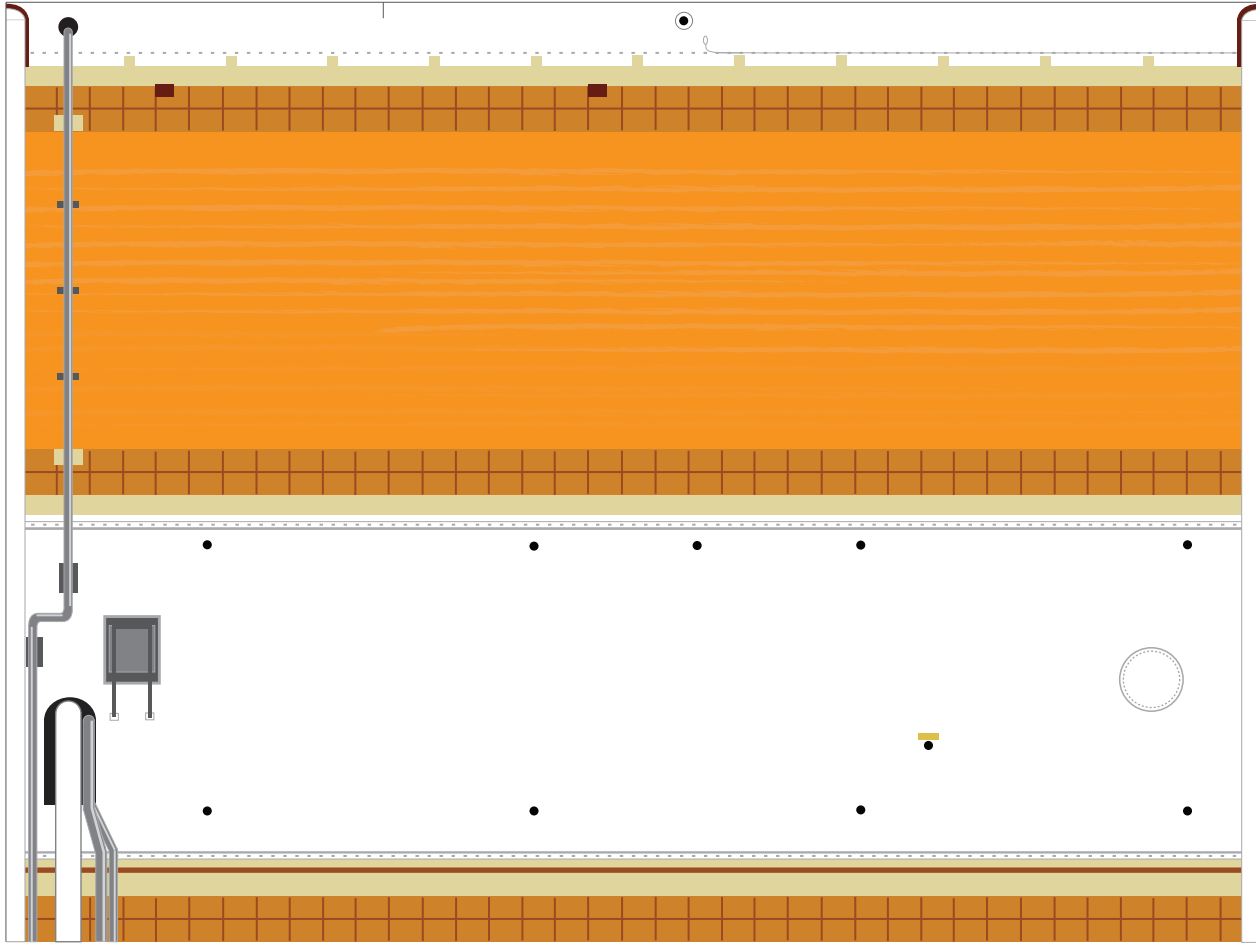



Right Delta IV Common Booster Core

Print on Cardstock (110 lbs)

1:96 Scale

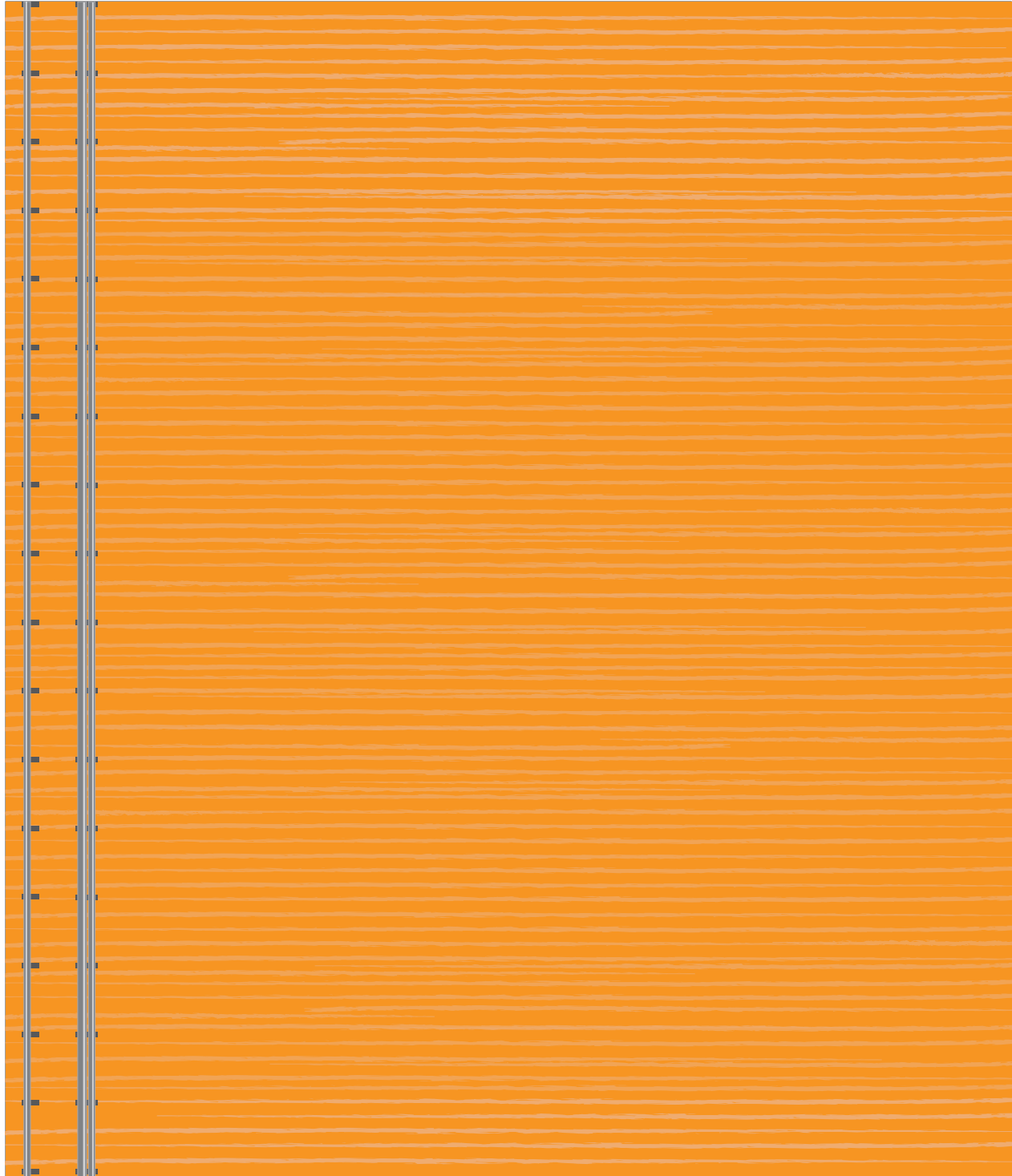



Print on Cardstock (110 lbs)

Delta IV Common Booster Core Nosecone

Print X 2

1:96 Scale

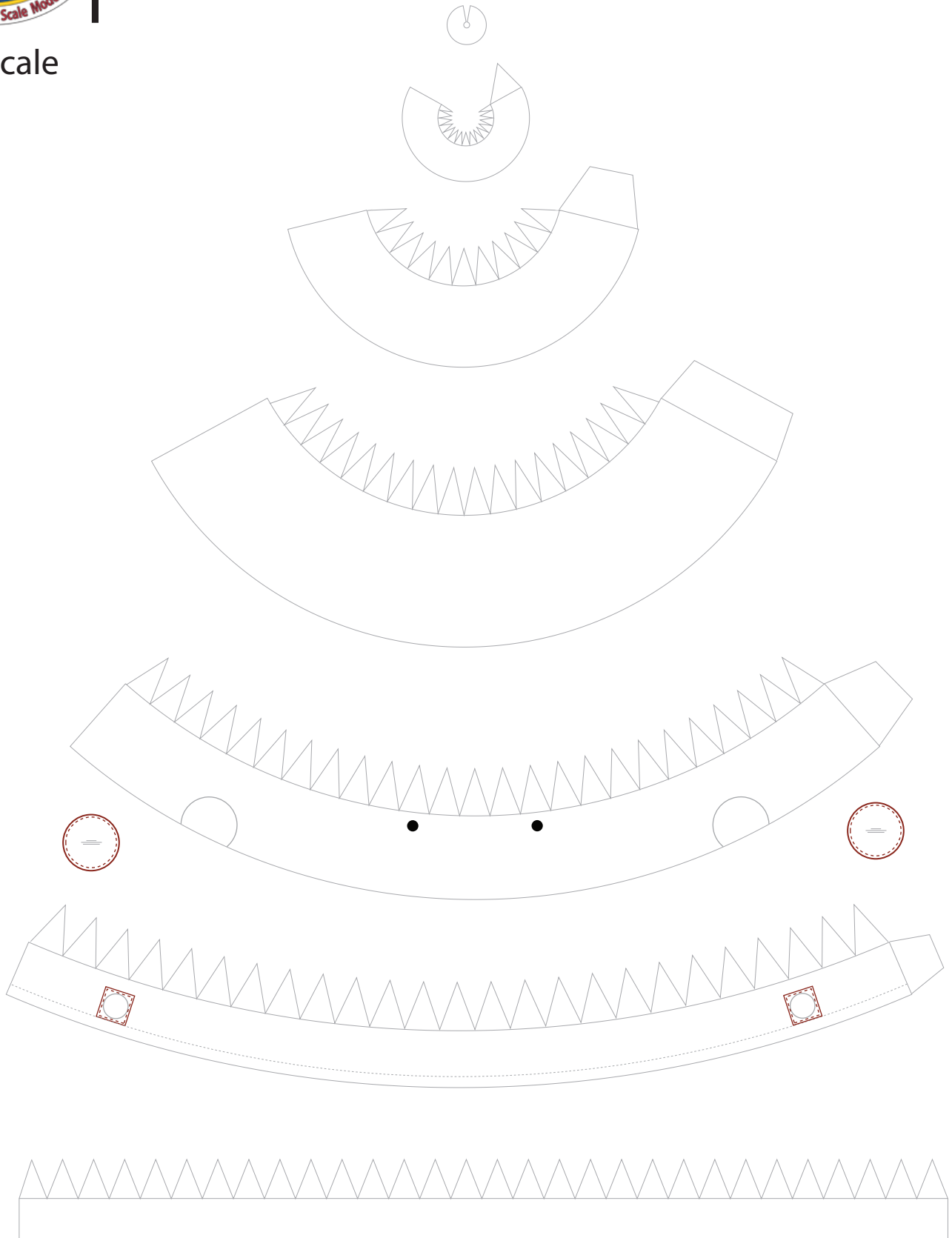

Connector for Common Booster Core



1 cm
1 inch

Print on Cardstock (110 lbs)

Delta IV Common Booster Core Attachments

1:96 Scale

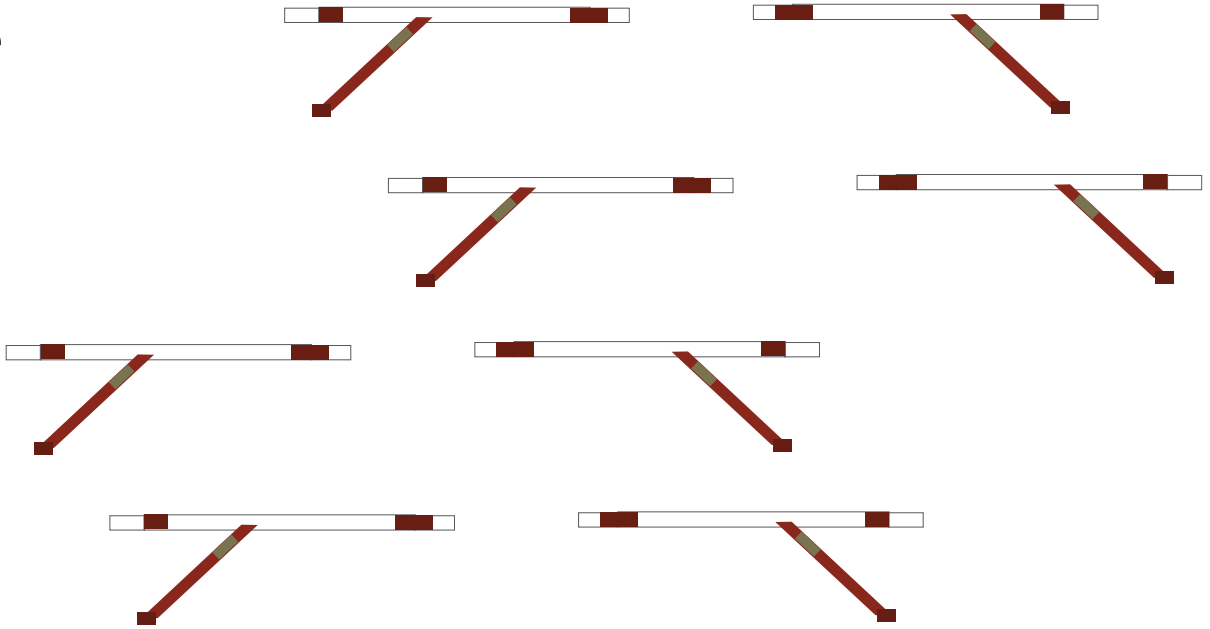

Center CBC
INTERSTAGE

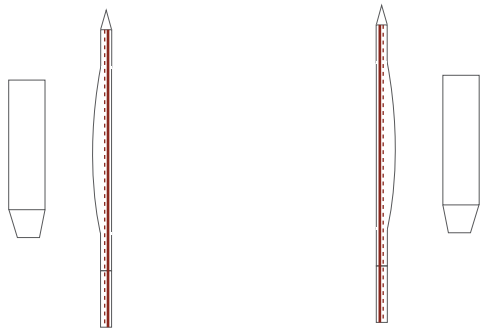

L CBC

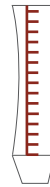

R CBC

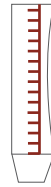

L CBC lower
attachments

R CBC lower
attachments

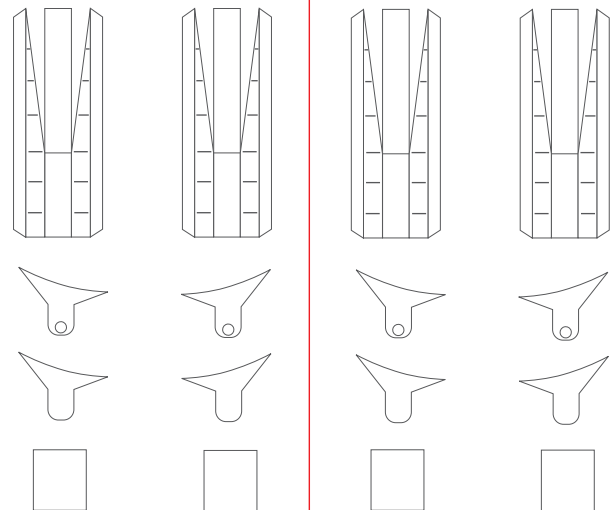

Center CBC lower attachments

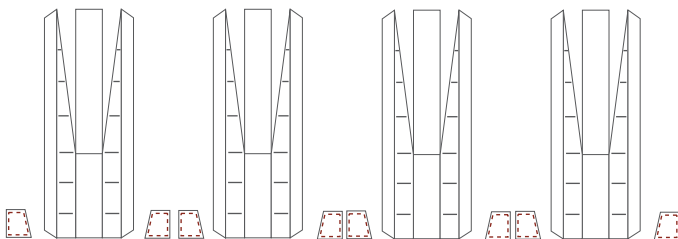



Delta IV Common Booster Core Connectors

Print on Cardstock (110 lbs)

1:96 Scale

Blank template for a connector part, featuring a dashed line for a fold.

Blank template for a connector part, featuring a dashed line for a fold.

Blank template for a connector part, featuring a dashed line for a fold.

Blank template for a connector part, featuring a dashed line for a fold.

Blank template for a connector part, featuring a dashed line for a fold.

Blank template for a connector part, featuring a dashed line for a fold.

Blank template for a connector part, featuring a dashed line for a fold.



Delta IV Common Booster Core

Engine section

Print on Cardstock (110 lbs)

Print x 3

1:96 Scale

CBC bottom connector

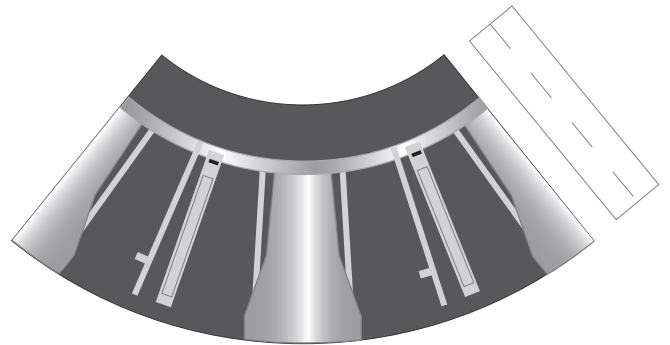
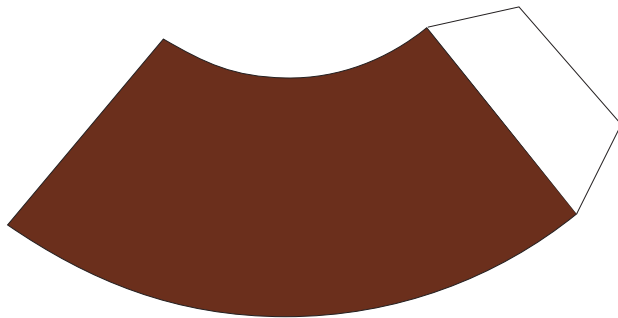
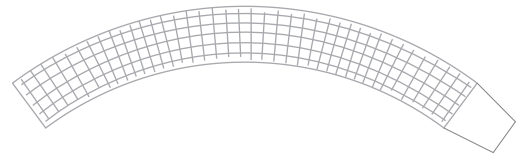
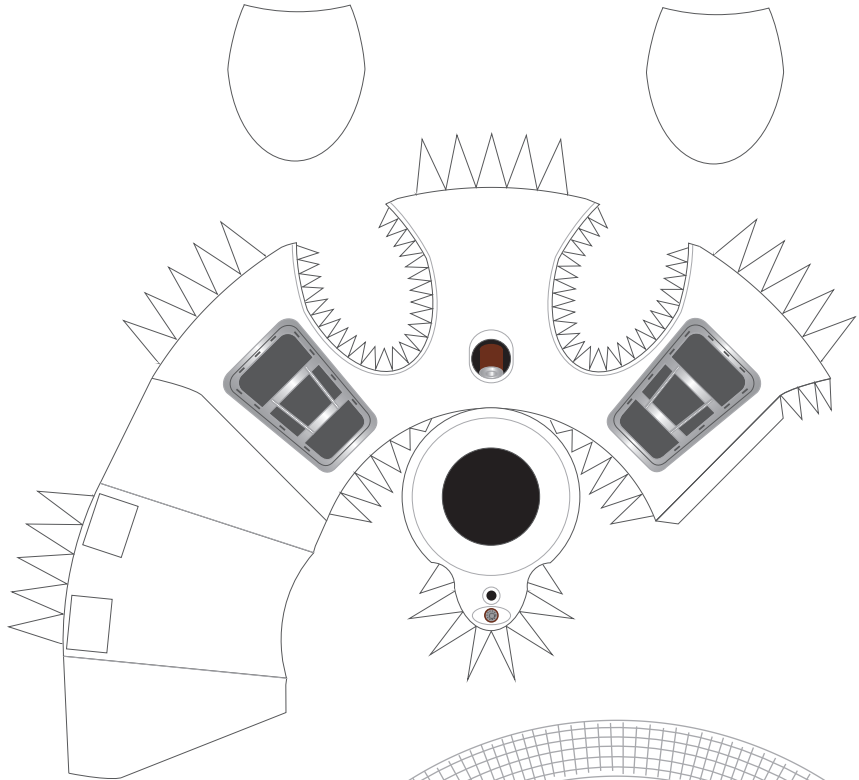
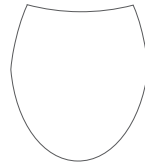
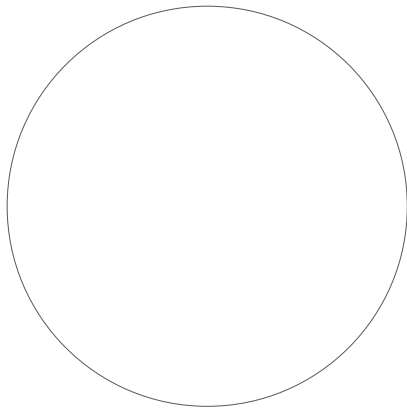
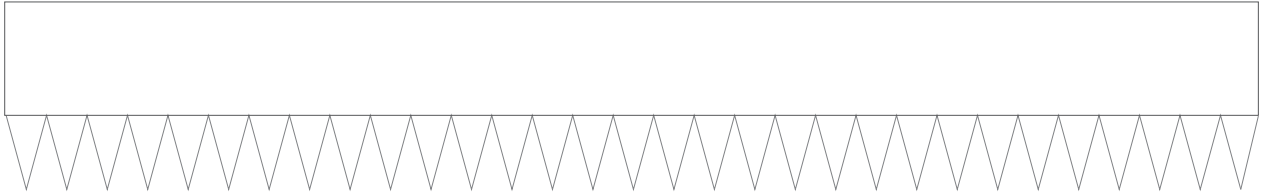



1 cm
1 inch

Delta IV Common Booster Core

Fuel Lines

Print x 3



Print on Cardstock (110 lbs)

1:96 Scale

