

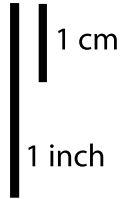

1:100 Scale



# SPACE-X "Falcon-9 v1.2"

Print on Cardstock (110 lbs)

Fairing 1.0 Revision

## Bulgaria Sat -1

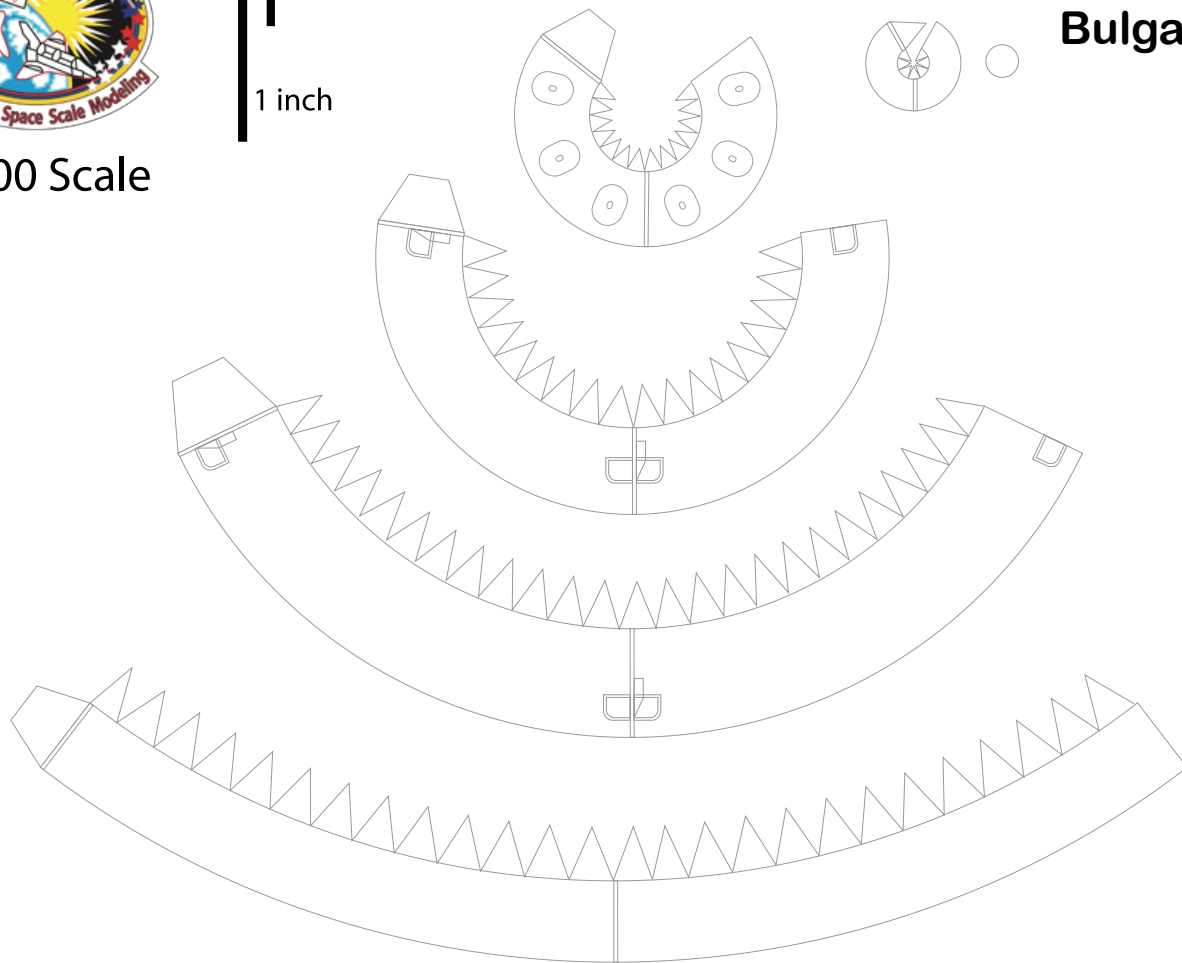



# SPACE-X "Falcon-9 v1.2"

Print on Cardstock (110 lbs)

Rev. 2

1 cm

1 inch

## Enlarged Second Stage / Interstage

1:100 Scale

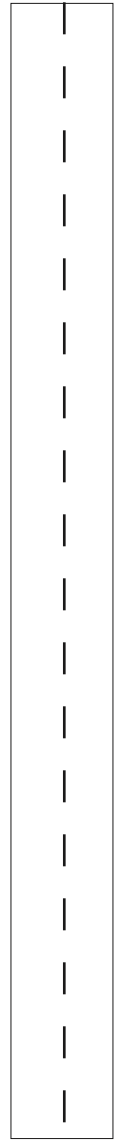
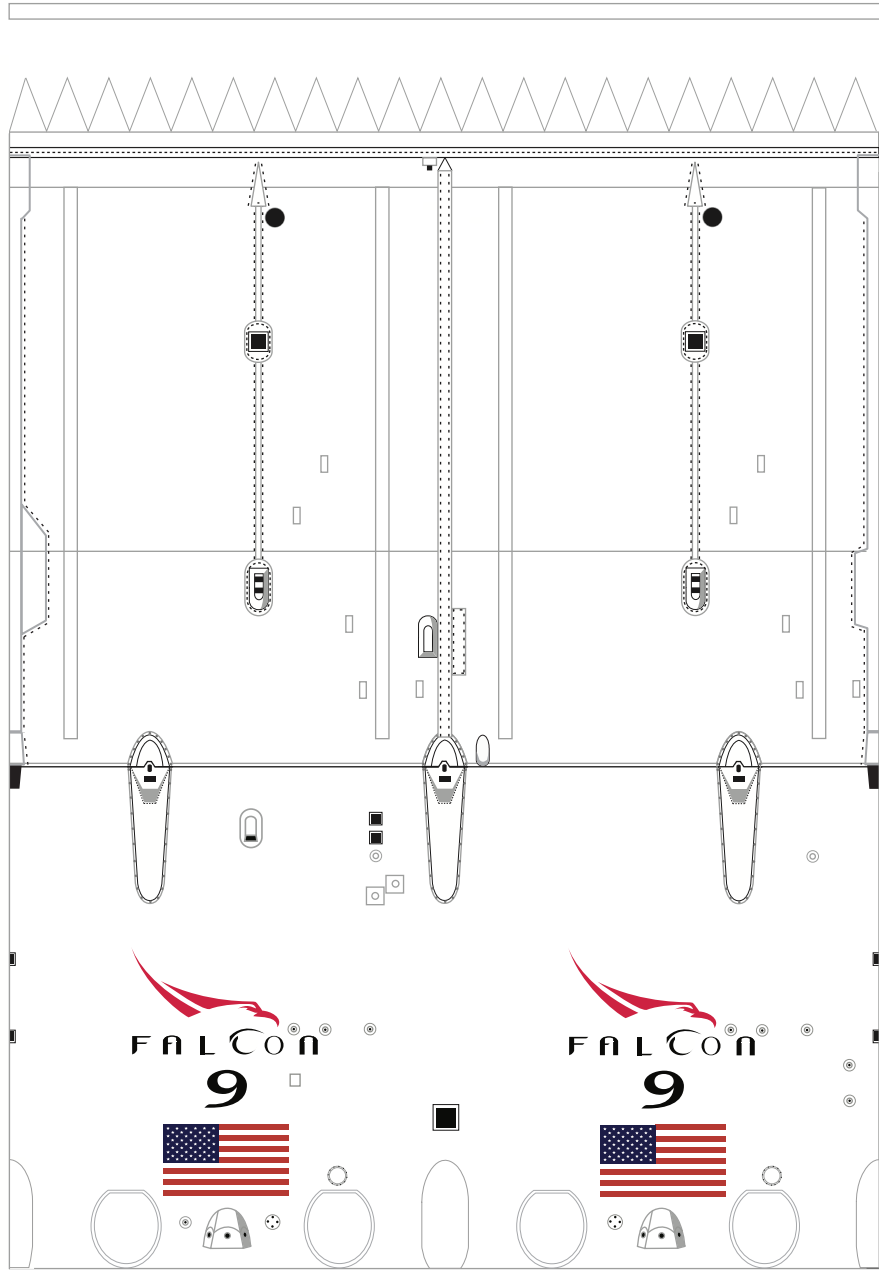
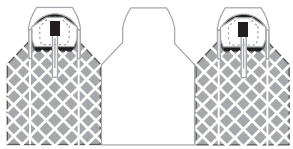
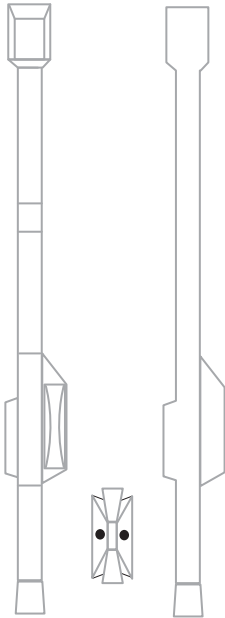

### Modified Grid Fins

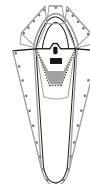
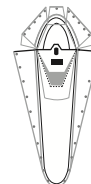
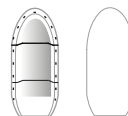
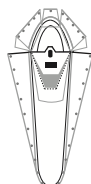



1:100 Scale

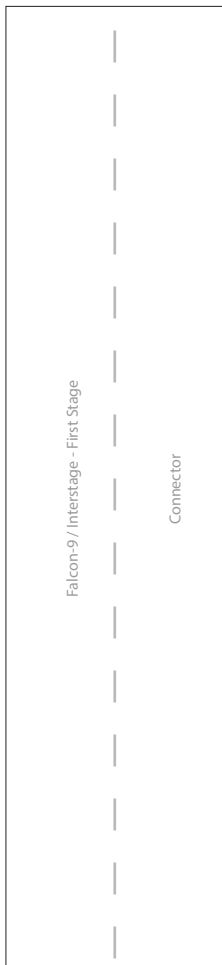

Falcon-9/ Interstage - First Stage

Connector



# SPACE-X "Falcon 9 v1.2"

Print on Cardstock (110 lbs)

Block 3

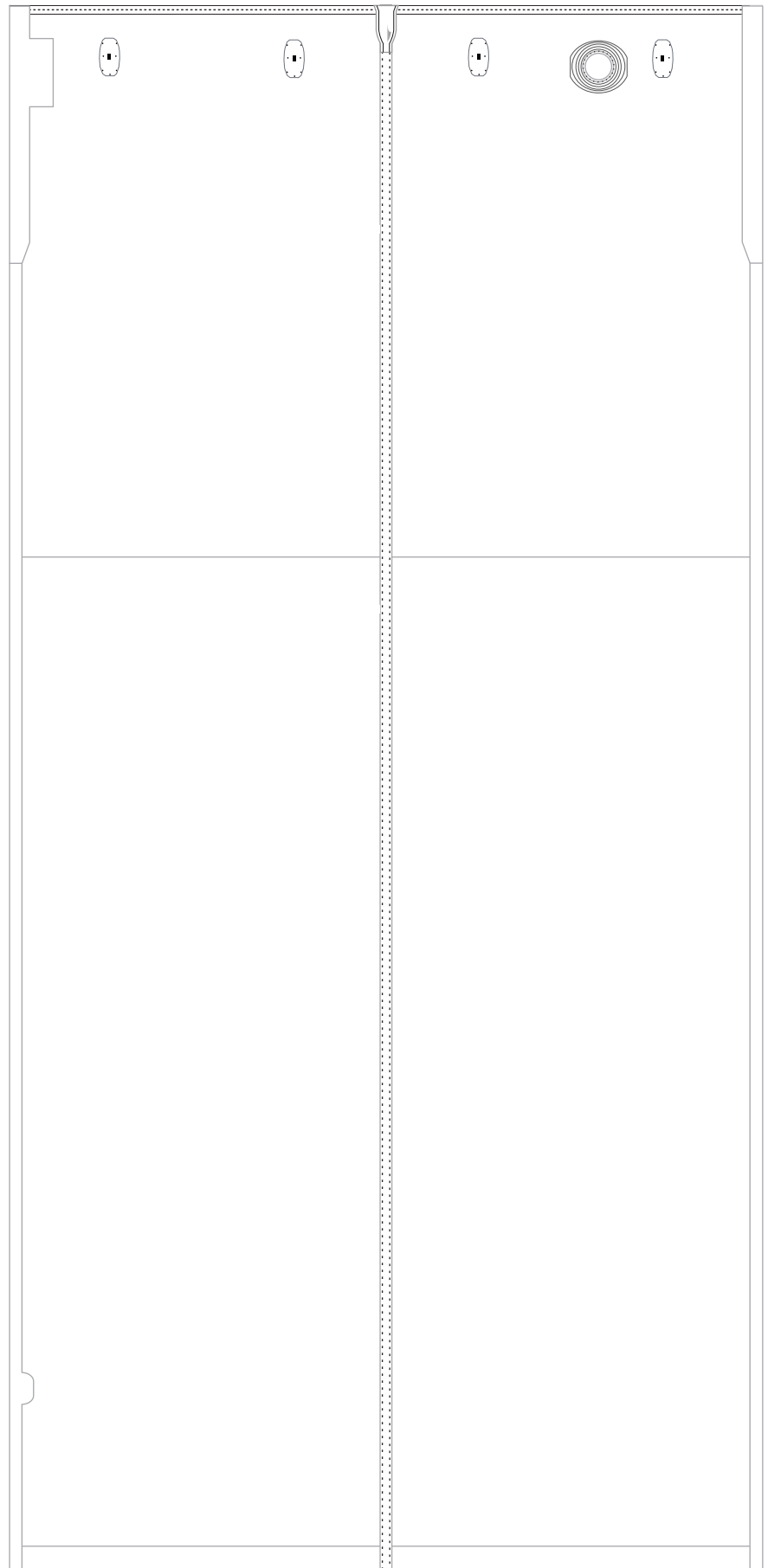



1:100 Scale



# SPACE-X "Falcon-9 v1.2"

Print on Cardstock (110 lbs)

Rev. 1

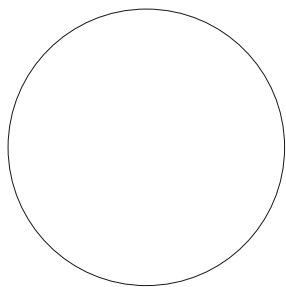
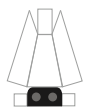
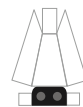
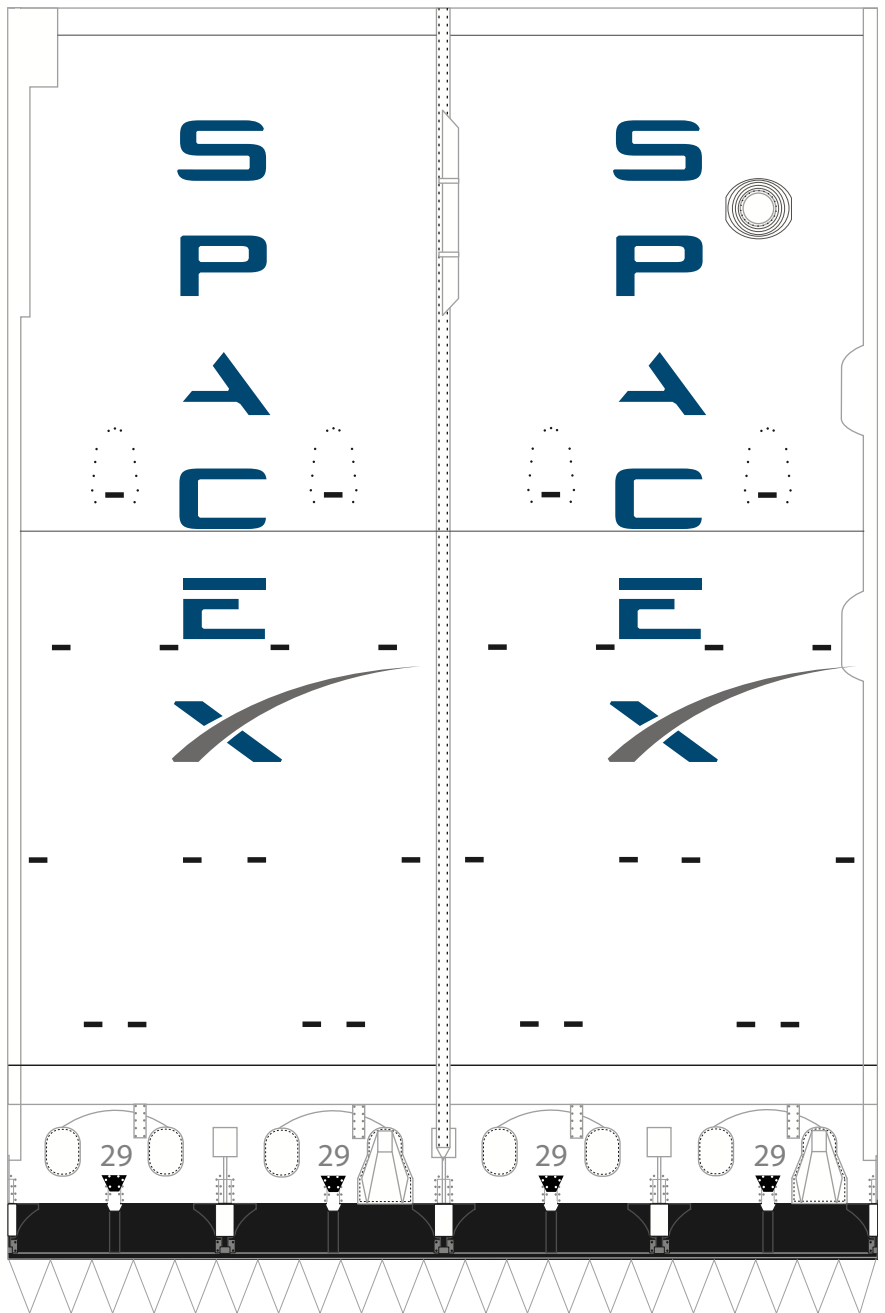
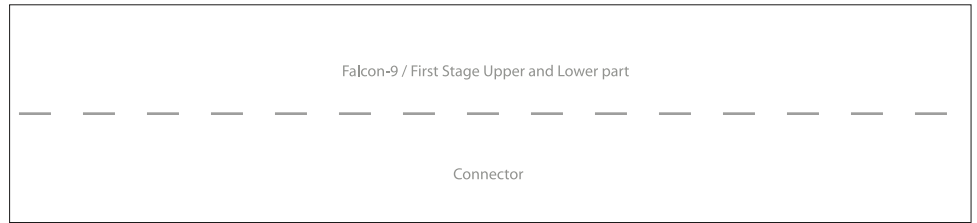



1:100 Scale



# SPACE-X "Falcon 9 v1.2"

Print on Cardstock (110 lbs)

Rev.1

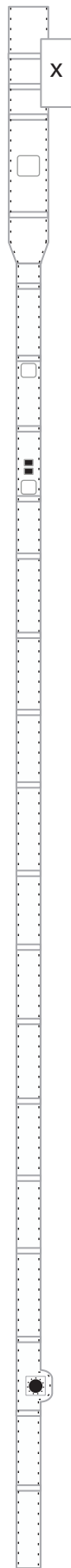
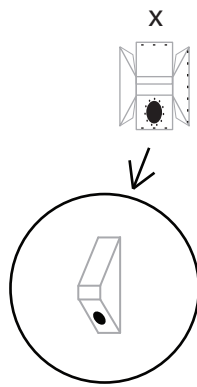

Thicker Raceway

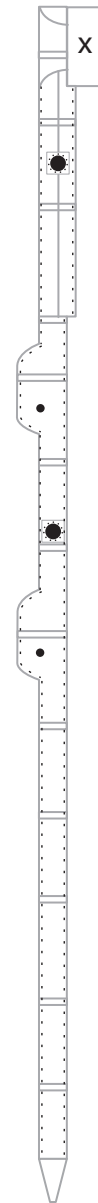

Fairing Connector

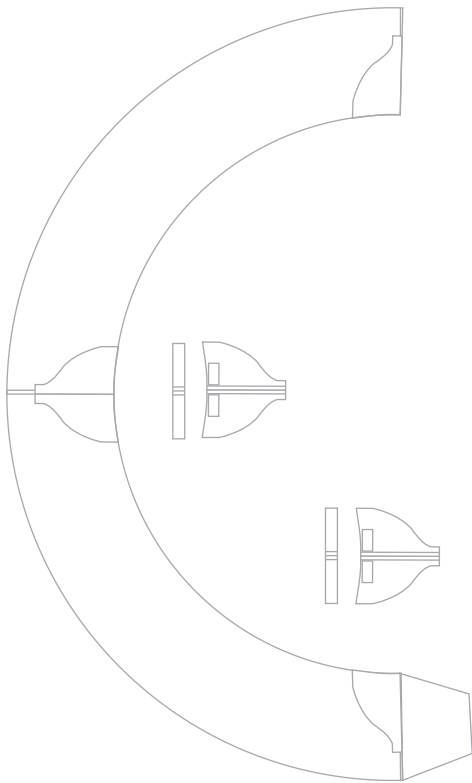



# SPACE-X "Falcon-9 v1.2"

Print on Cardstock (110 lbs)

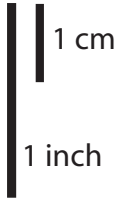

## LEGS



1:100 Scale

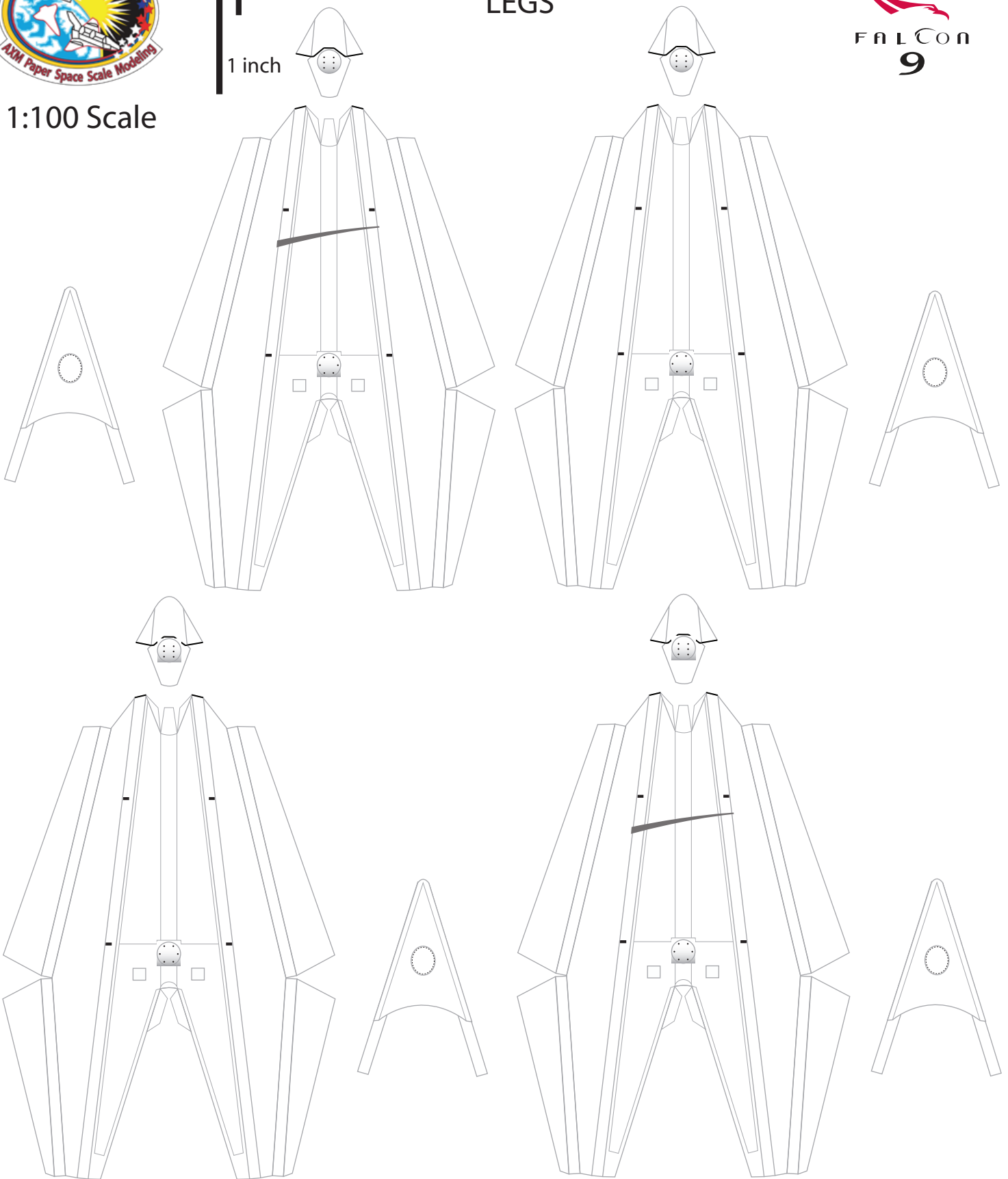



# SPACE-X "Falcon-9 v1.2"

Print on Cardstock (110 lbs)

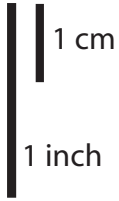

LEGS page 2



1:100 Scale

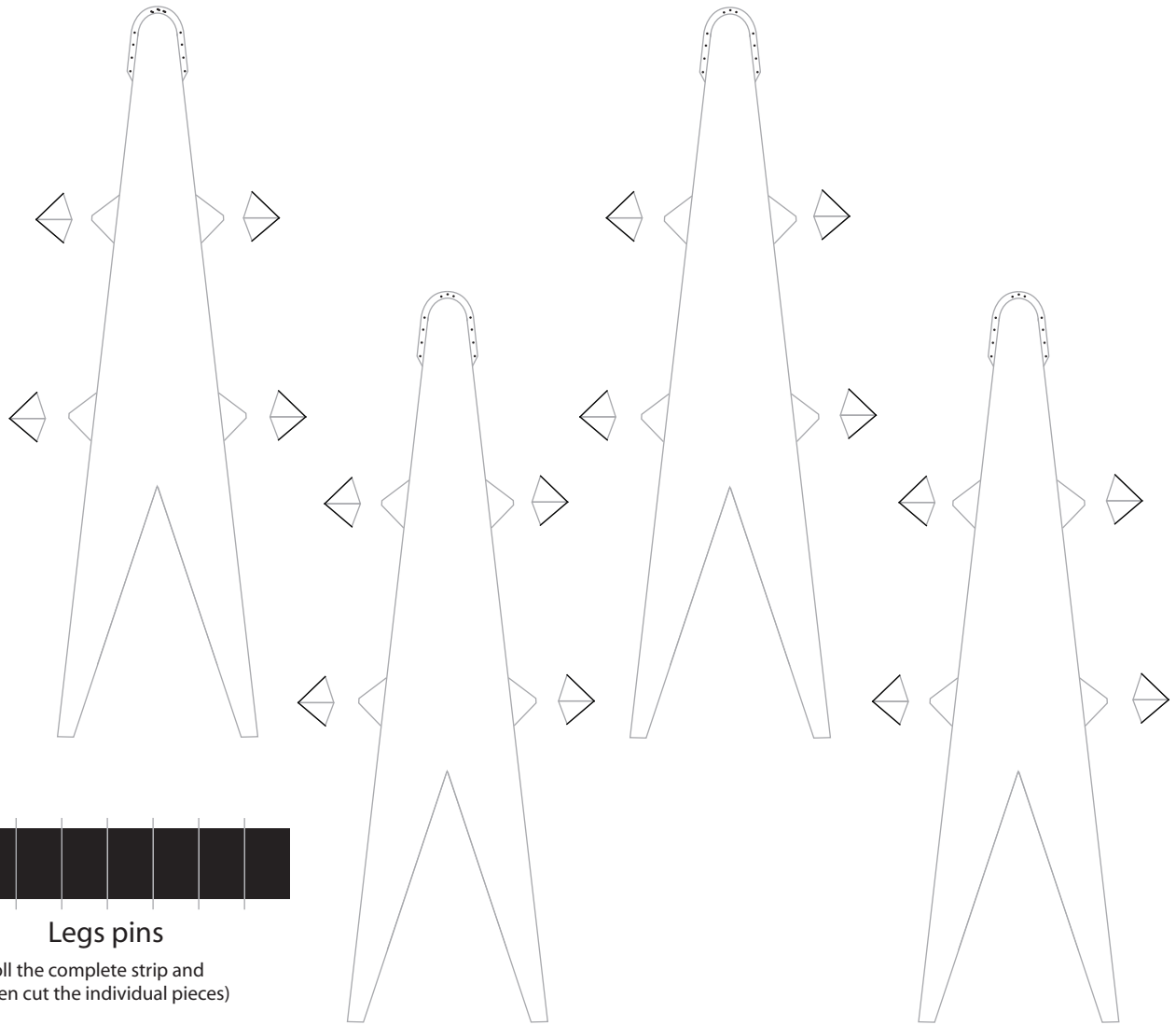

Legs pins

(roll the complete strip and then cut the individual pieces)

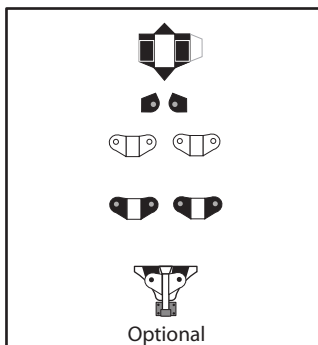

Optional

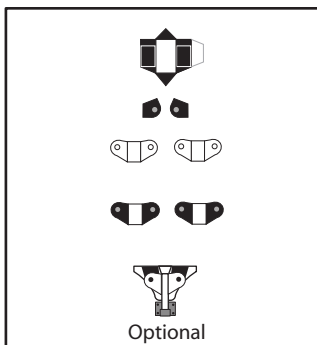

Optional

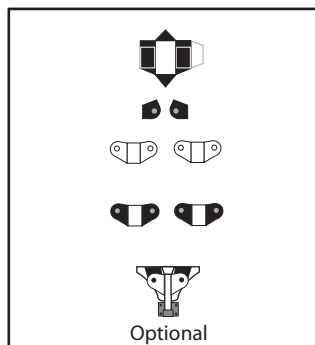

Optional

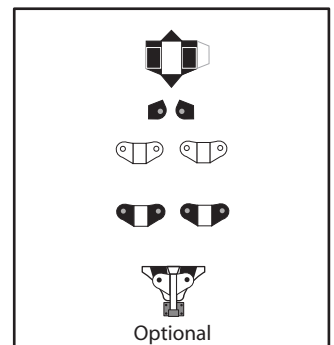

Optional



1:100 Scale



# SPACE-X "Falcon-9 v1.2"

## MERLIN Engines

Print on Cardstock (110 lbs)

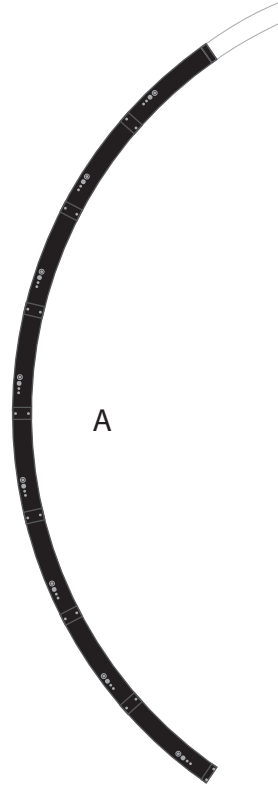
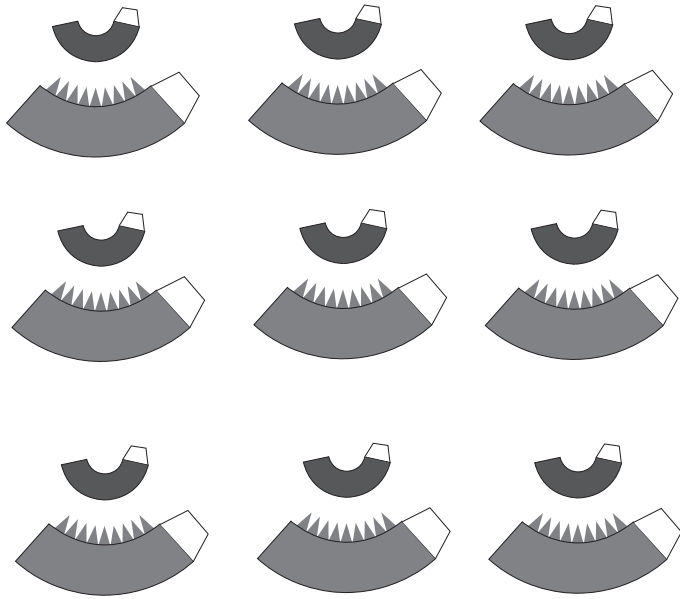

C

B

A

D

C

B

A

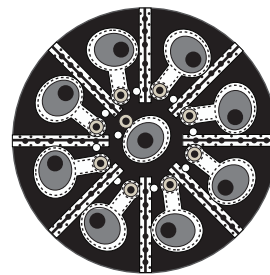
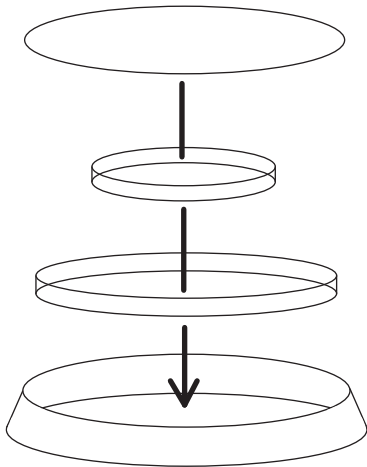

D

Engine Grid  
OCTAWEB