



SPACE-X "Falcon-9 v1.2"

Print on Cardstock (110 lbs)

Fairing 1.0 Revision

EchoStar-XXIII

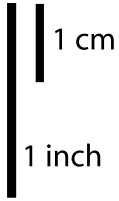

1:100 Scale

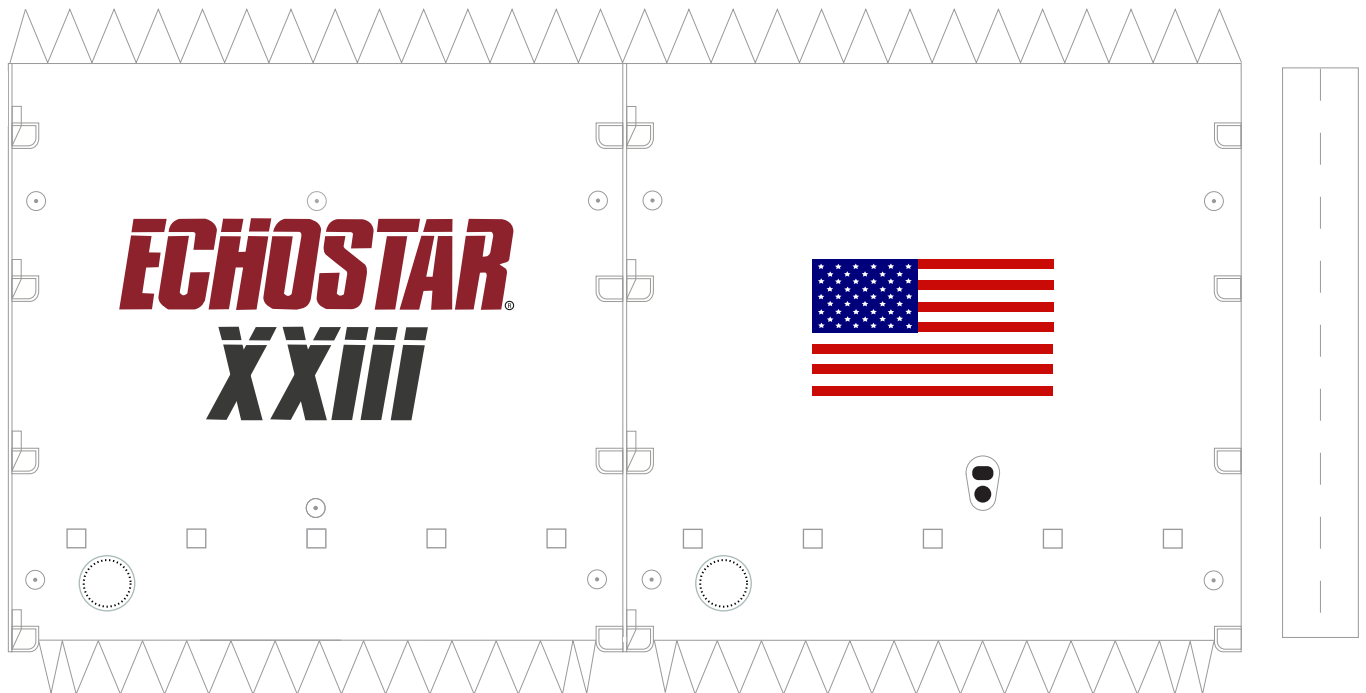
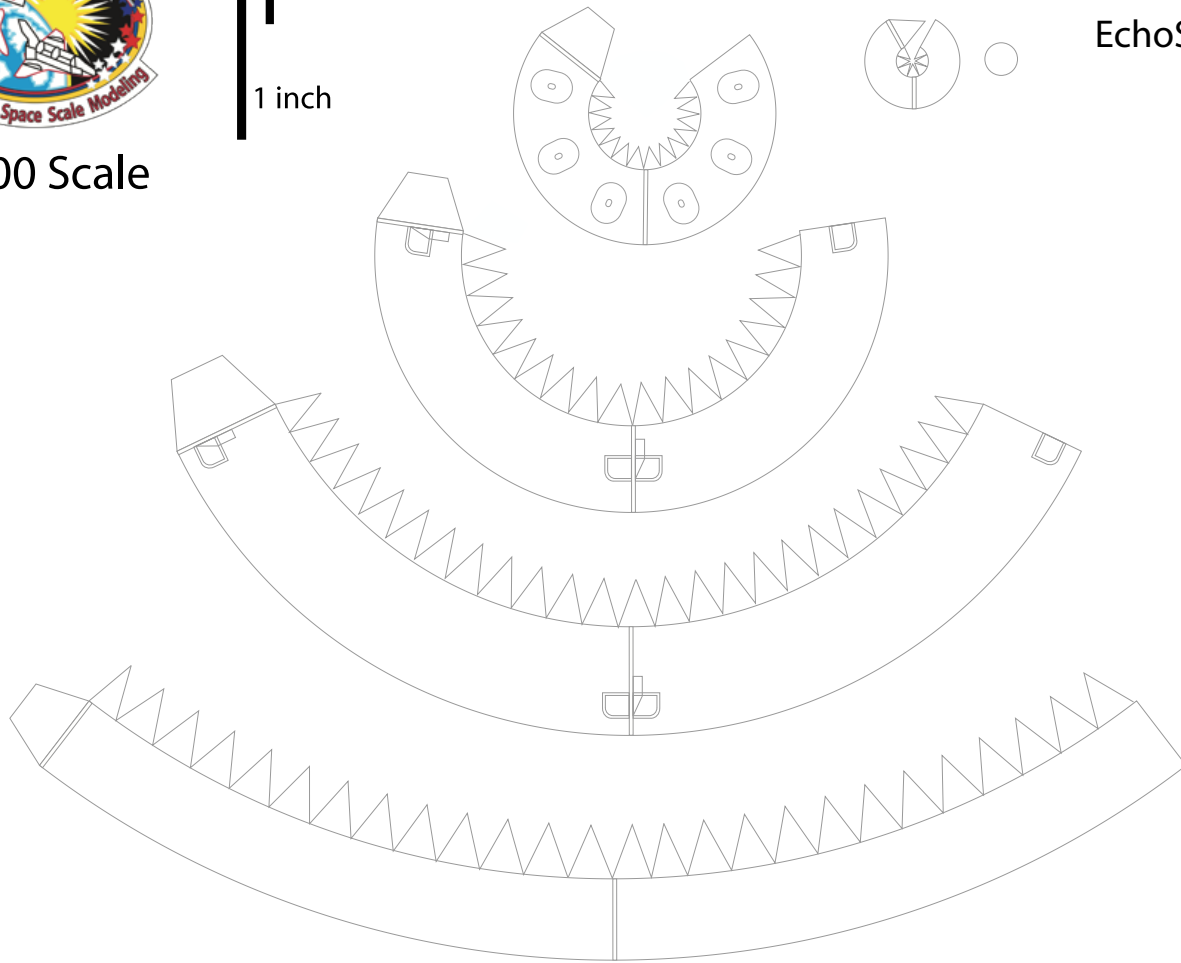



SPACE-X "Falcon-9 v1.2"

Print on Cardstock (110 lbs)

1 cm

1 inch

Enlarged Second Stage / Interstage

1:100 Scale

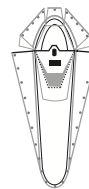
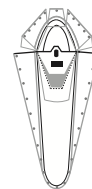
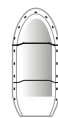
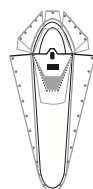
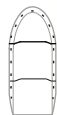
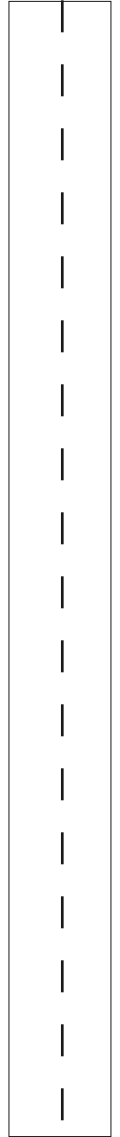
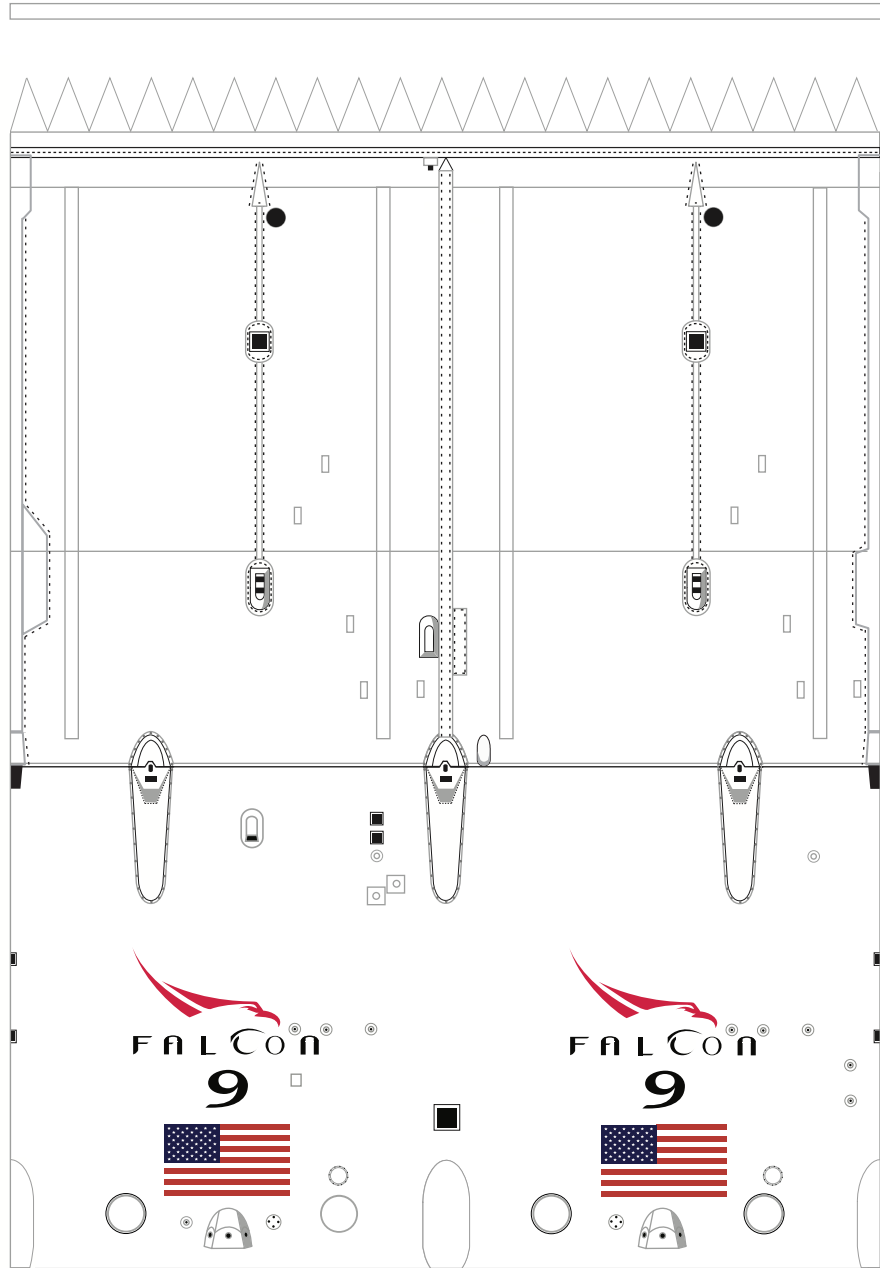
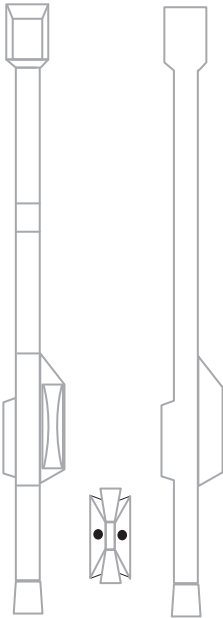



1:100 Scale



FALCON
9

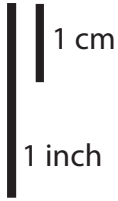
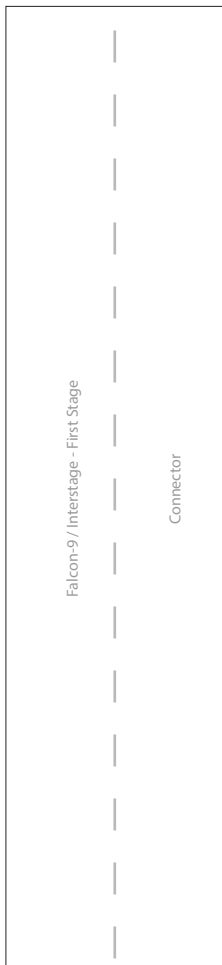

SPACE-X "Falcon 9 v1.2"

Print on Cardstock (110 lbs)

Block 3

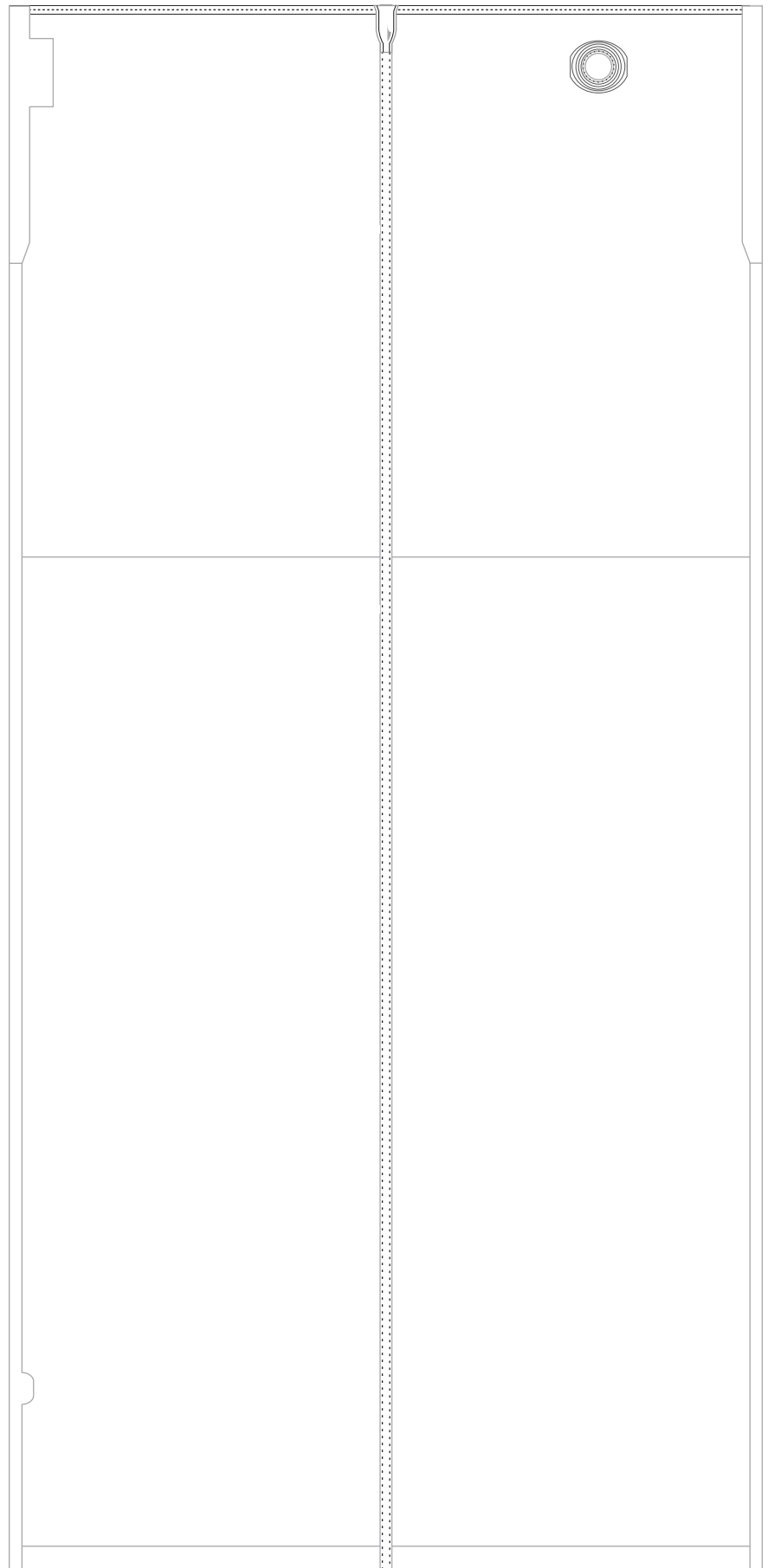



SPACE-X "Falcon-9 v1.2"

Print on Cardstock (110 lbs)

Rev. 1

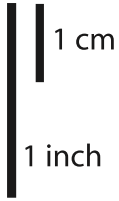

1:100 Scale

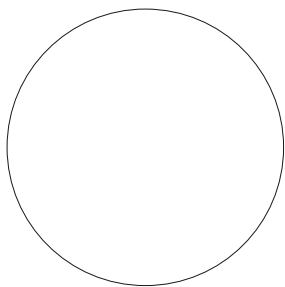
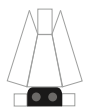
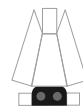
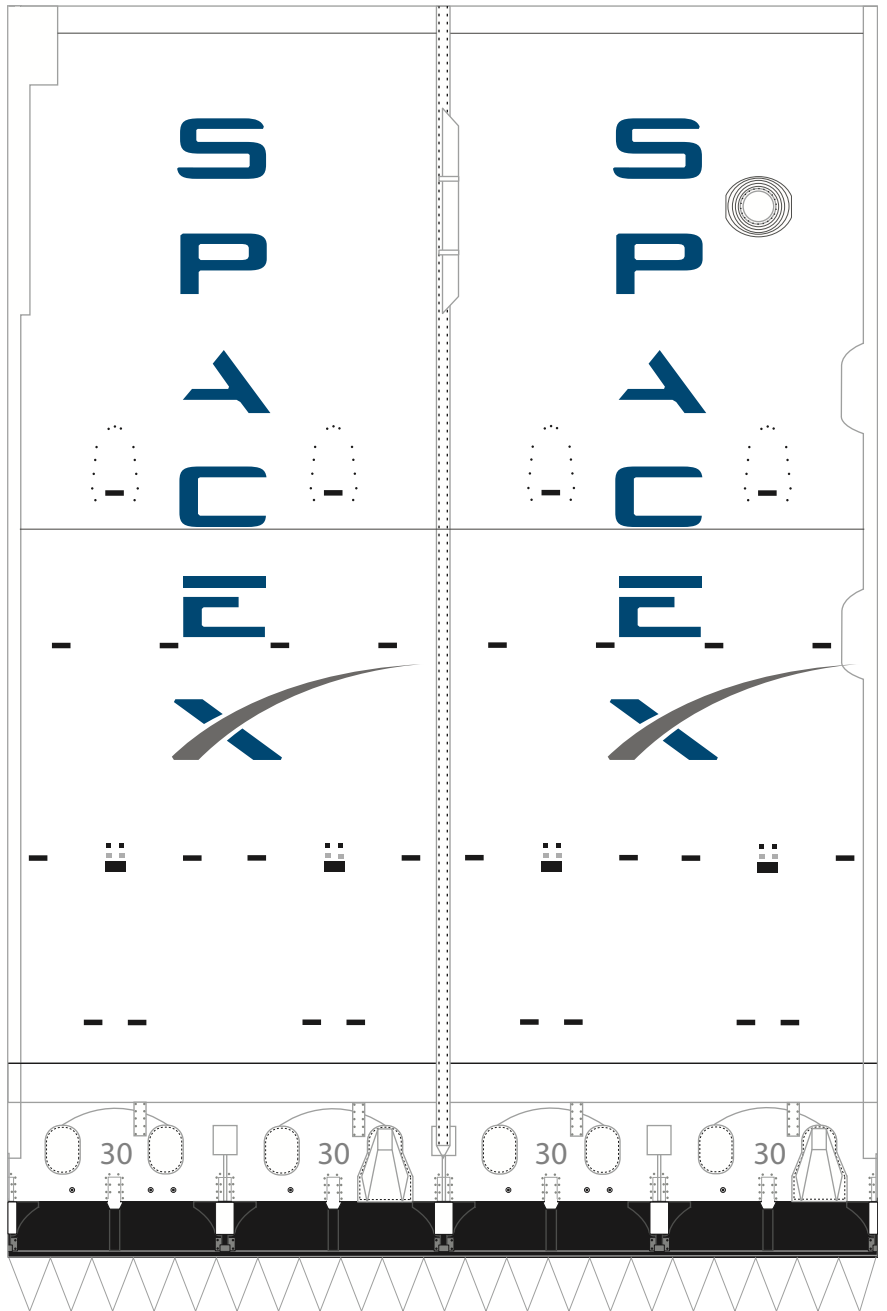
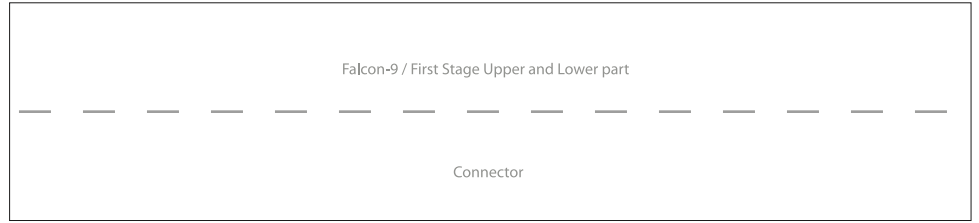



1:100 Scale



SPACE-X "Falcon 9 v1.2"

Print on Cardstock (110 lbs)

Rev.1

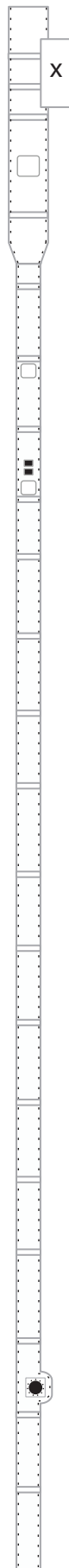
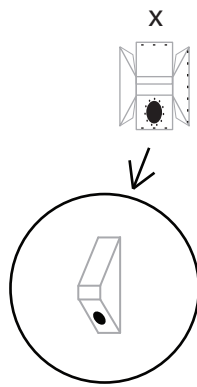

Thicker Raceway

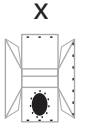
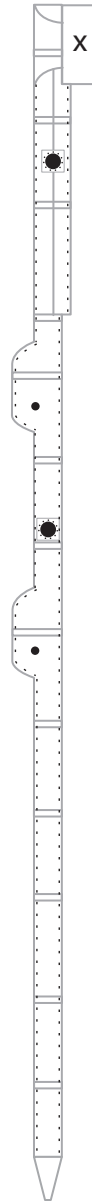

Fairing Connector

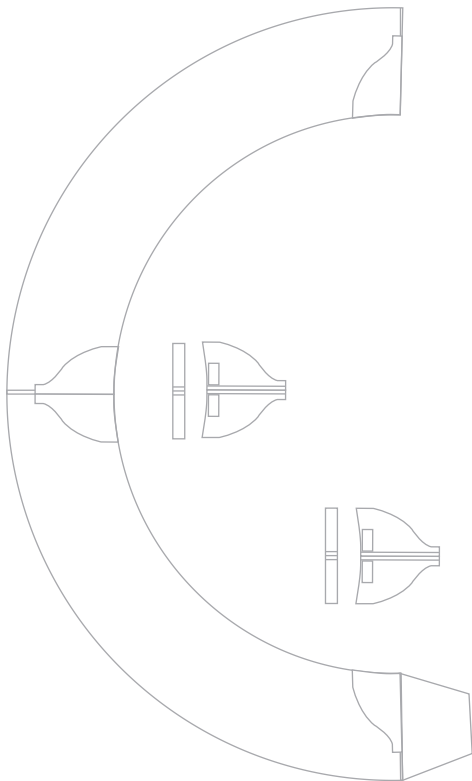



1:100 Scale

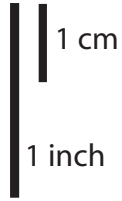

SPACE-X "Falcon-9 v1.2"

MERLIN Engines

Print on Cardstock (110 lbs)

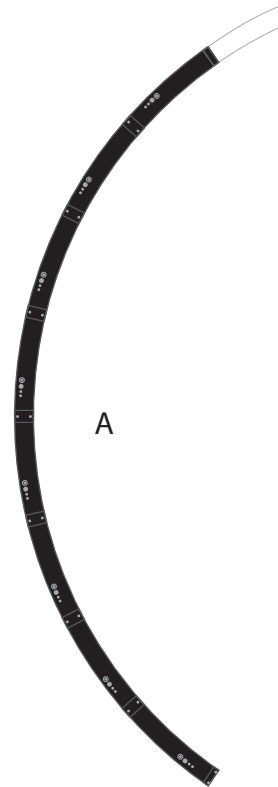
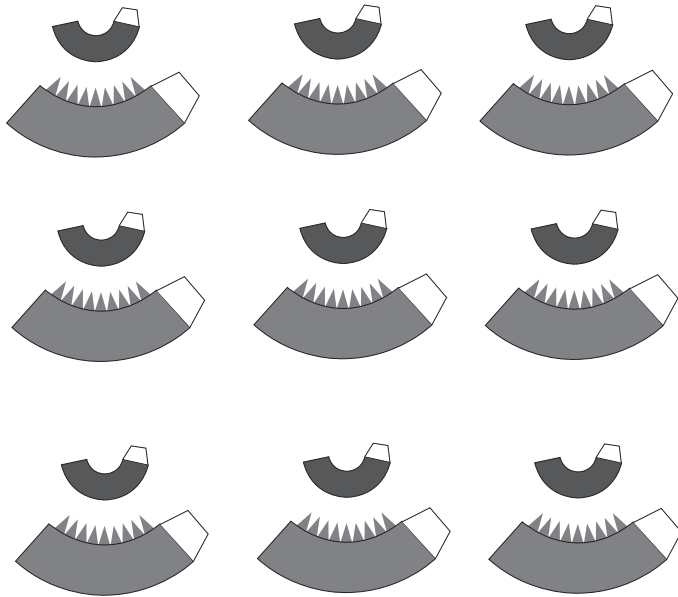

C

B

A

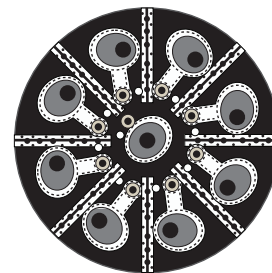
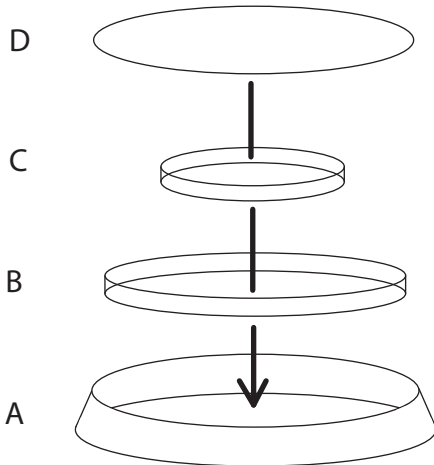

D

Engine Grid
OCTAWEB