

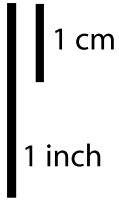

1:100 Scale



SPACE-X "Falcon-9 v1.2"

Print on Cardstock (110 lbs)

Fairing 1.0 Revision

KoreaSat-5A

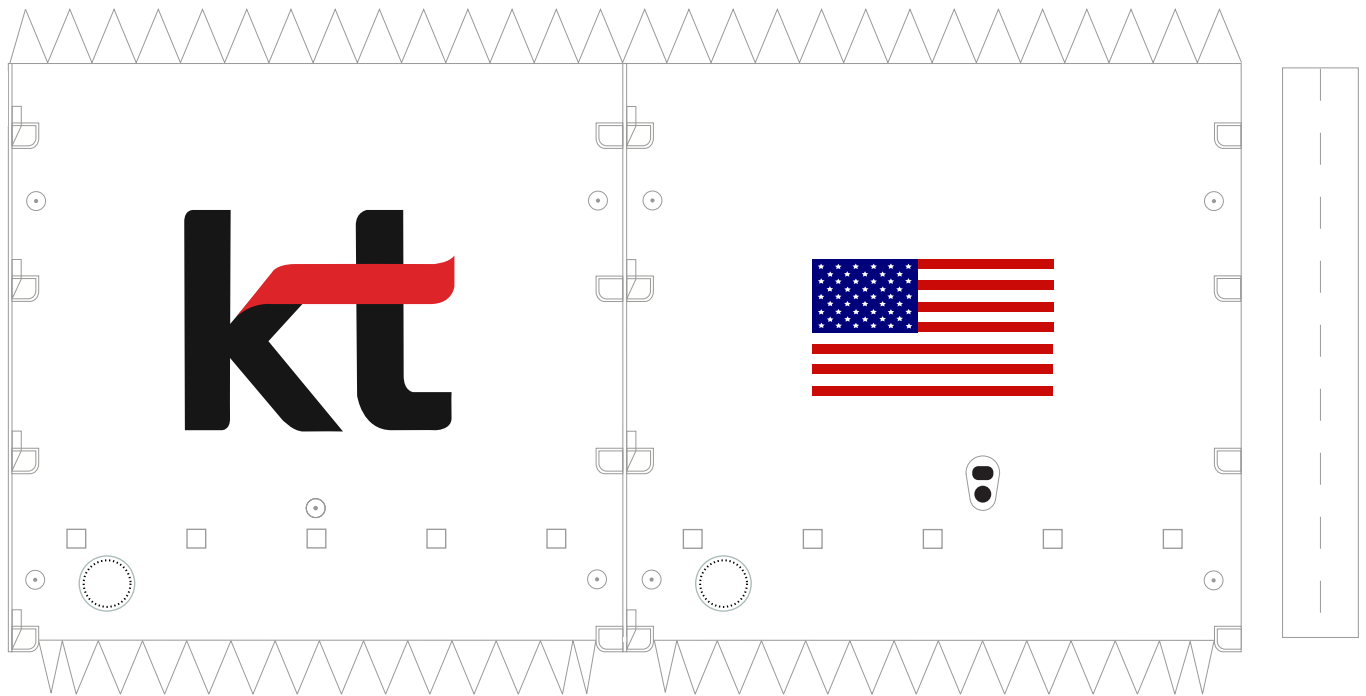
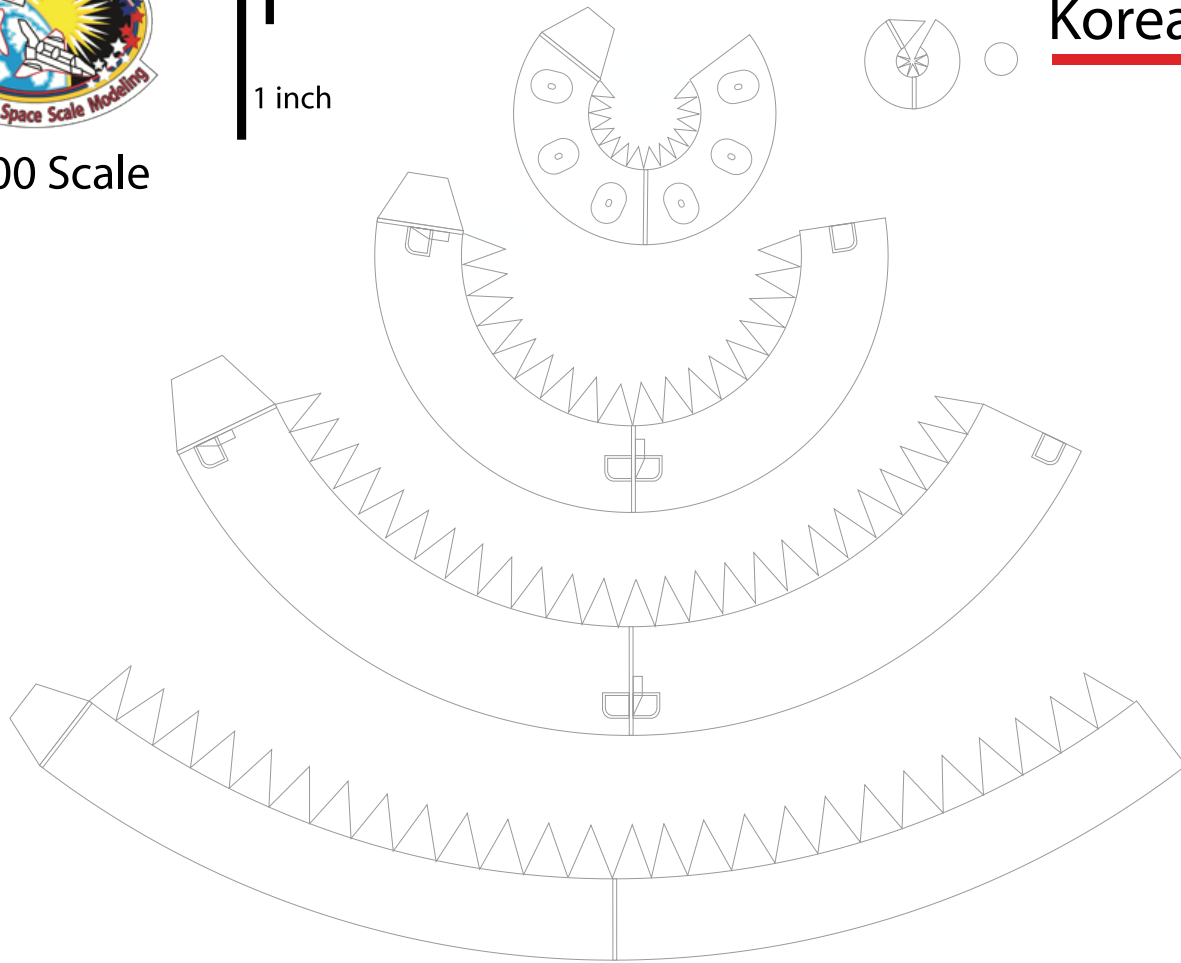



SPACE-X "Falcon-9 v1.2"

Print on Cardstock (110 lbs)

1 cm

Enlarged Second Stage / Interstage

Block 4 Second Stage
Aluminum Grid Fins

1 inch

1:100 Scale



FALCON 9

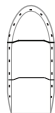
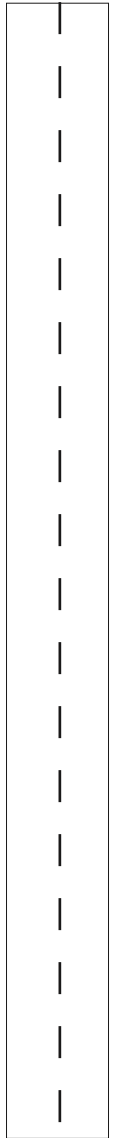
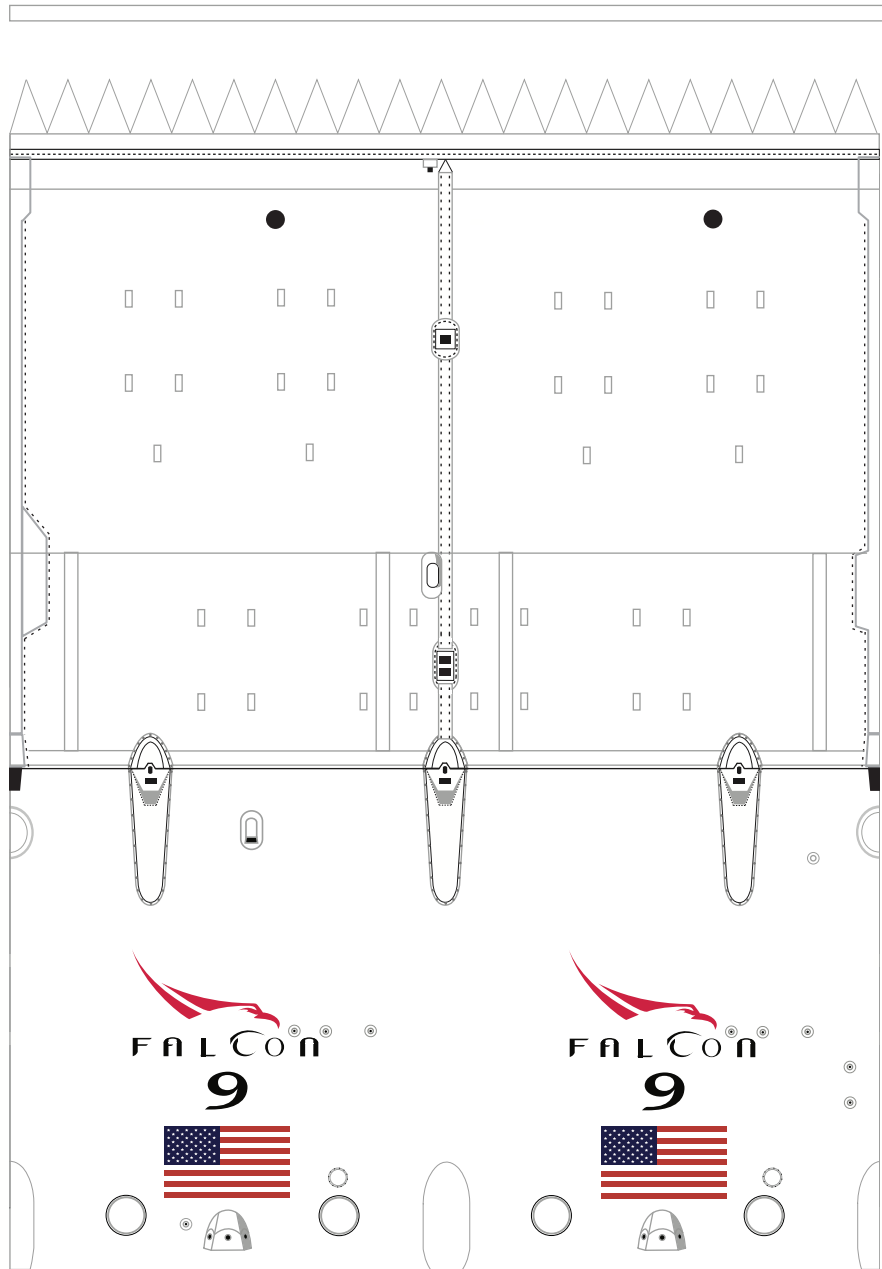
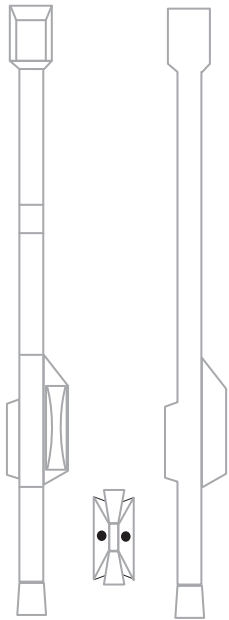

Old Grid Fins

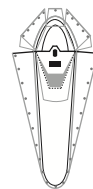
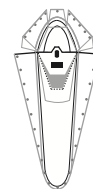
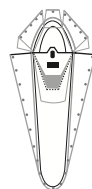



1:100 Scale

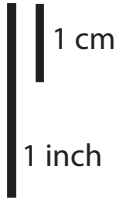
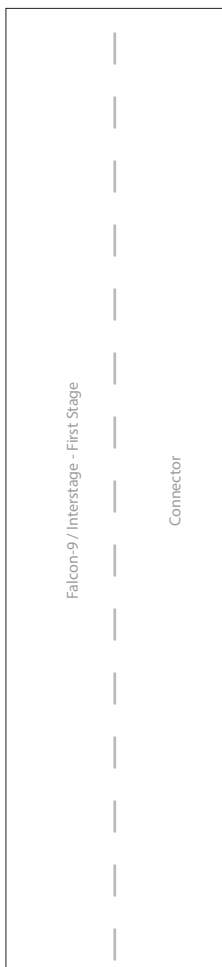

SPACE-X "Falcon 9 v1.2"

Print on Cardstock (110 lbs)

Block 4

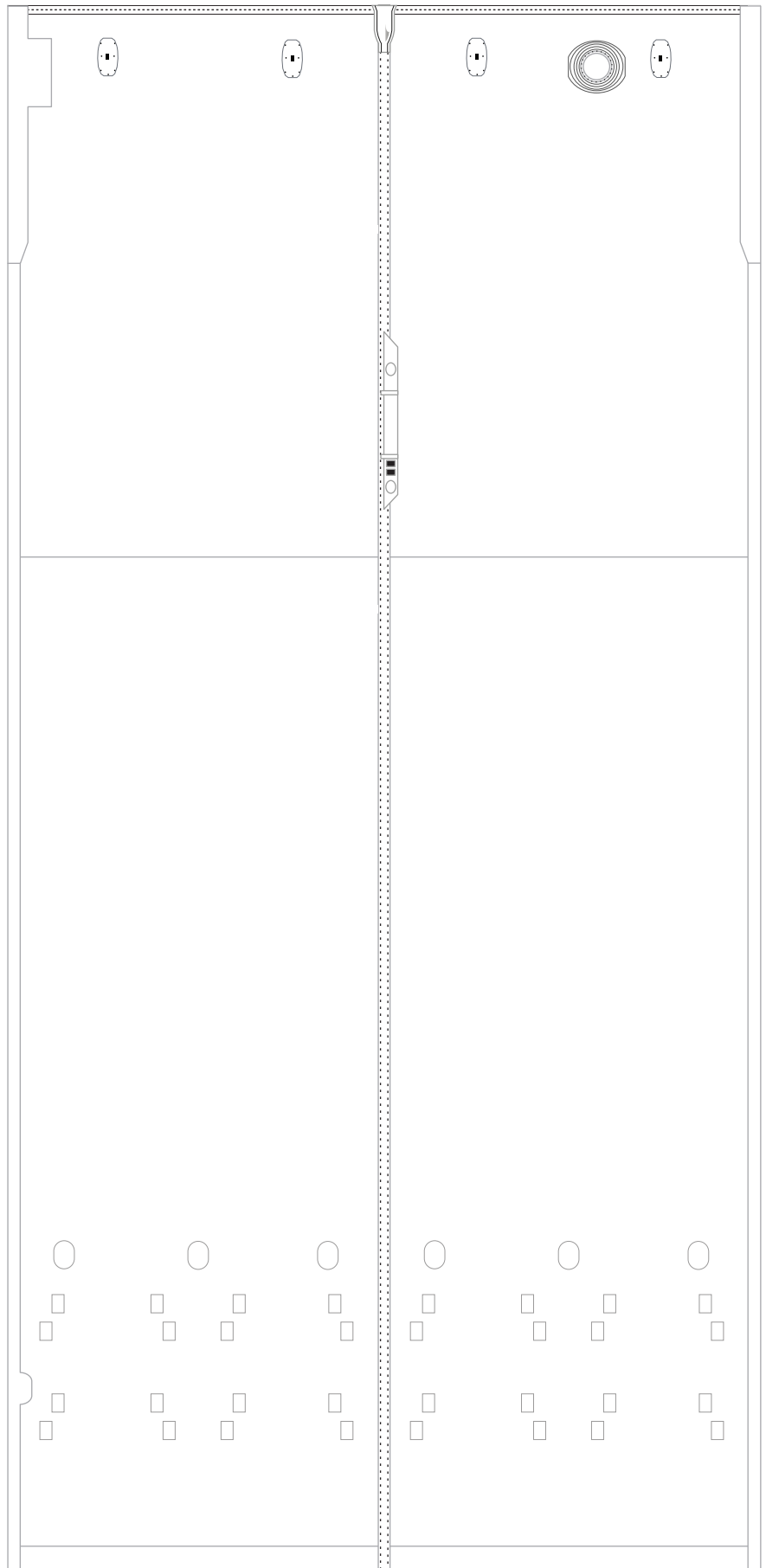



1:100 Scale



FALCON
9

SPACE-X "Falcon-9 v1.2"

Print on Cardstock (110 lbs)

Block 4

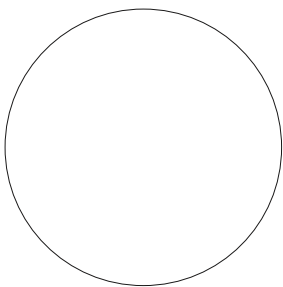
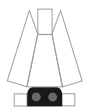
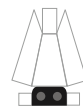
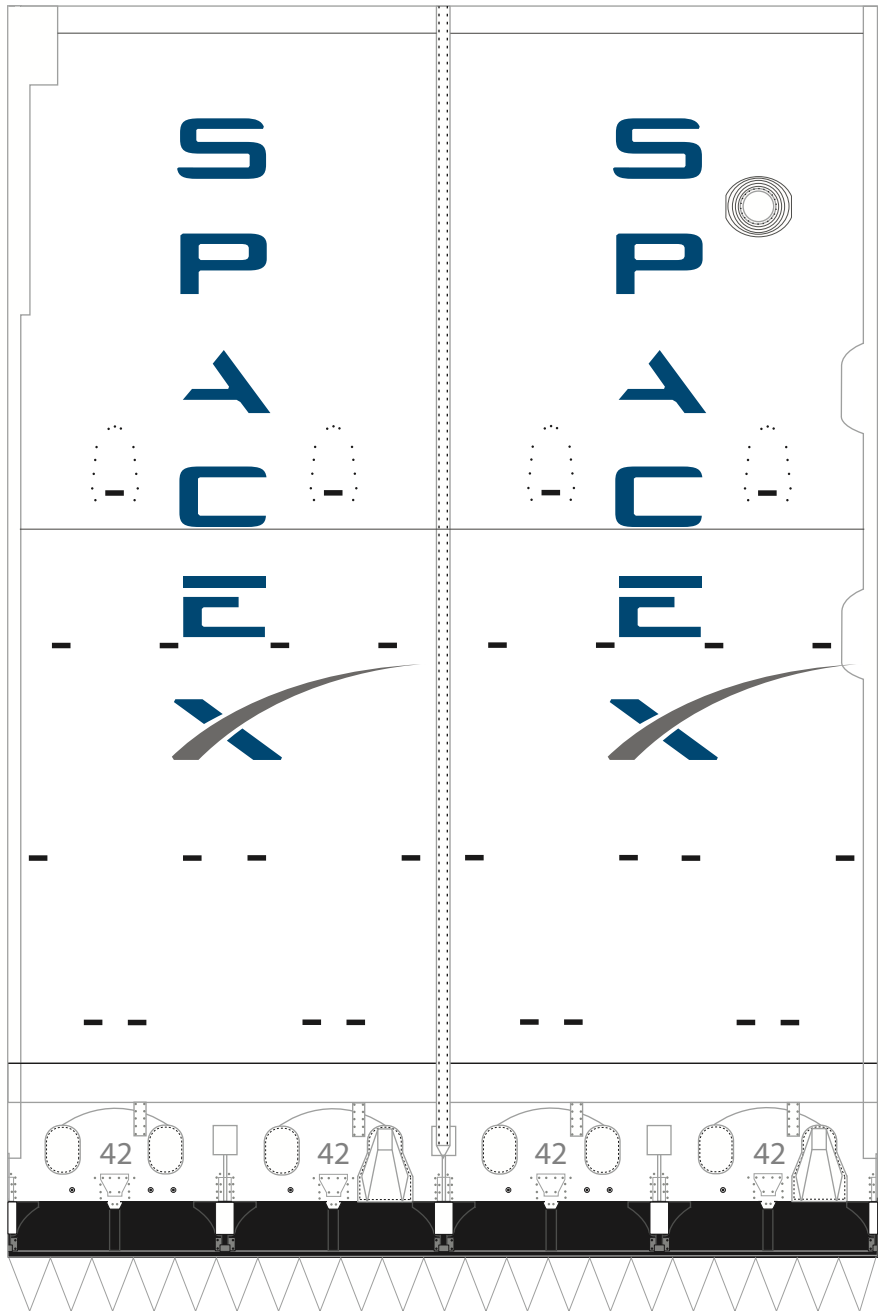
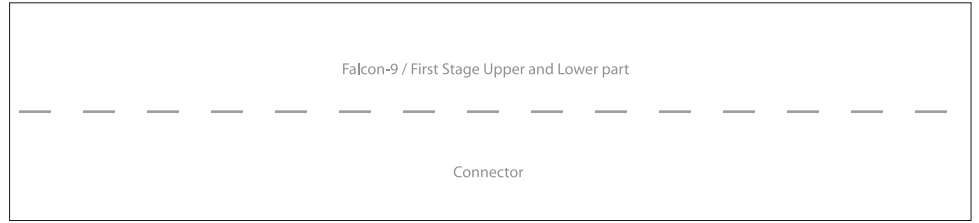
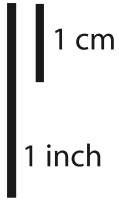



1:100 Scale



SPACE-X "Falcon 9 v1.2"

Print on Cardstock (110 lbs)

Rev.1

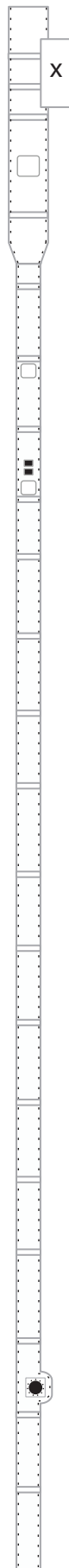
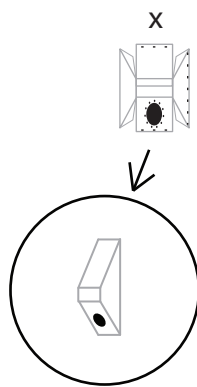

Thicker Raceway

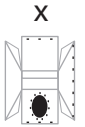
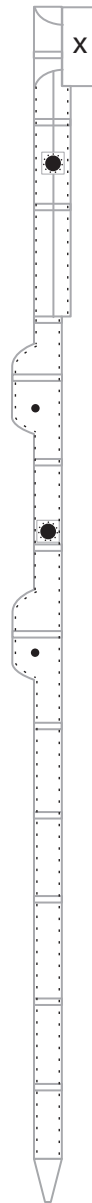

Fairing Connector

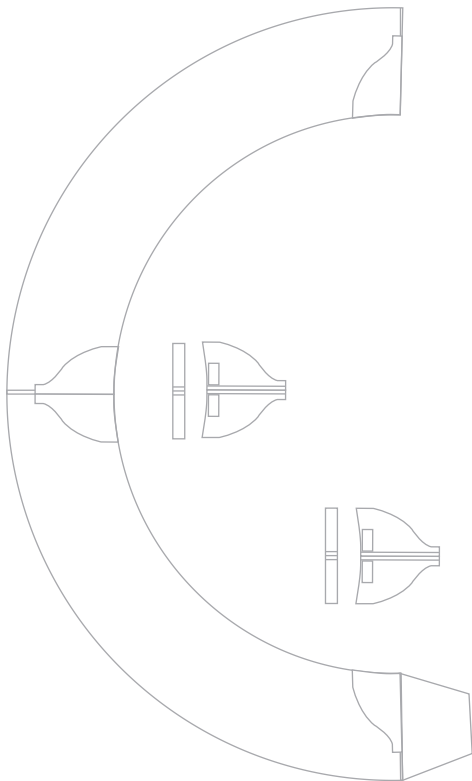



SPACE-X "Falcon-9 v1.2"

Print on Cardstock (110 lbs)

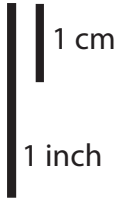

LEGS



1:100 Scale

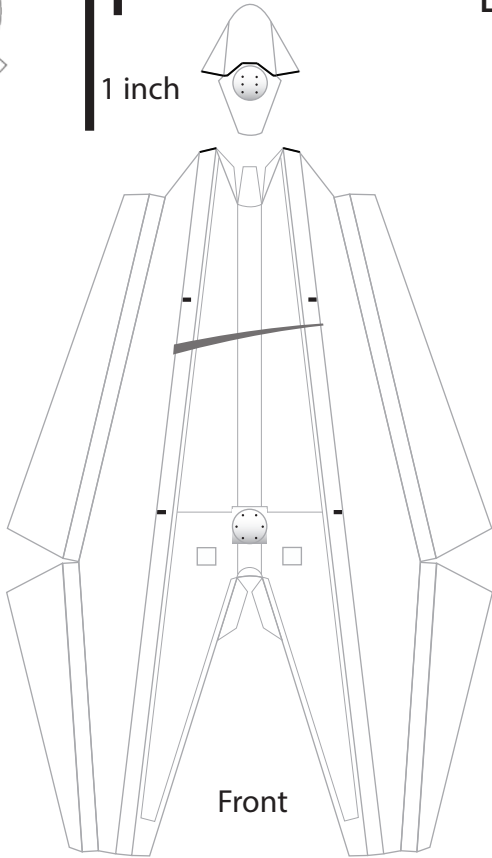
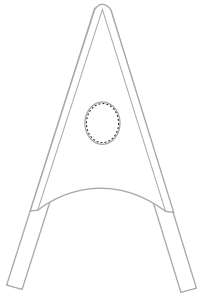

Front

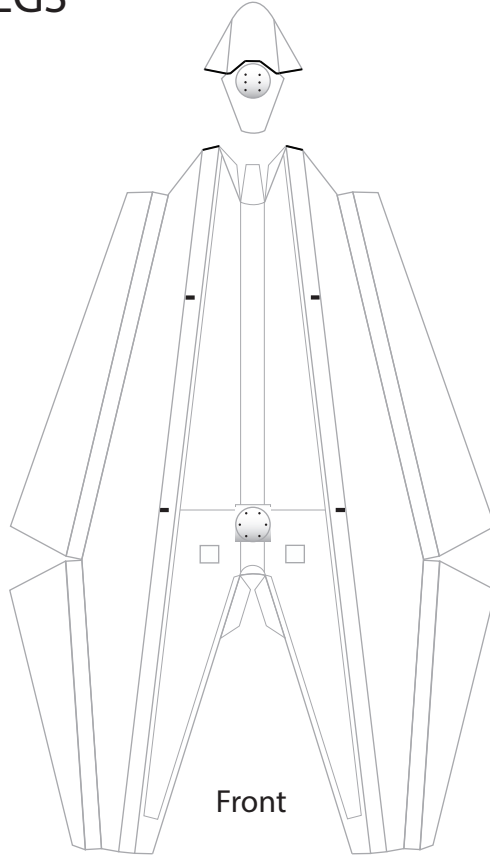

Front

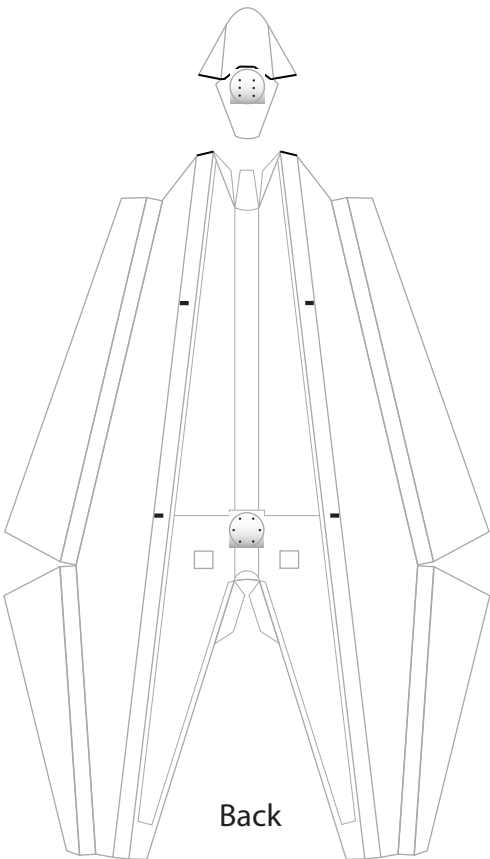
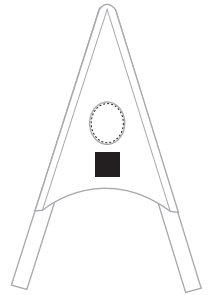

Back

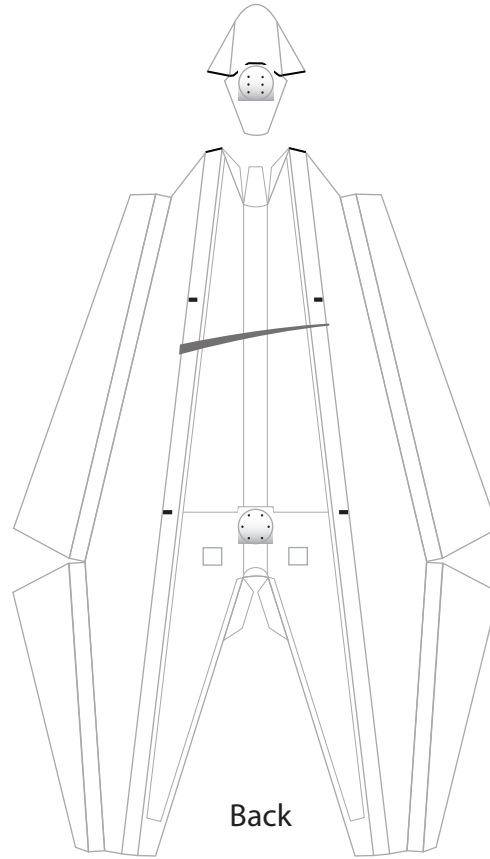
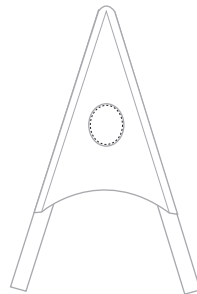

Back





SPACE-X "Falcon-9 v1.2"

Print on Cardstock (110 lbs)

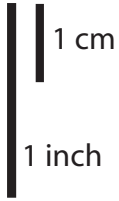

LEGS page 2



1:100 Scale

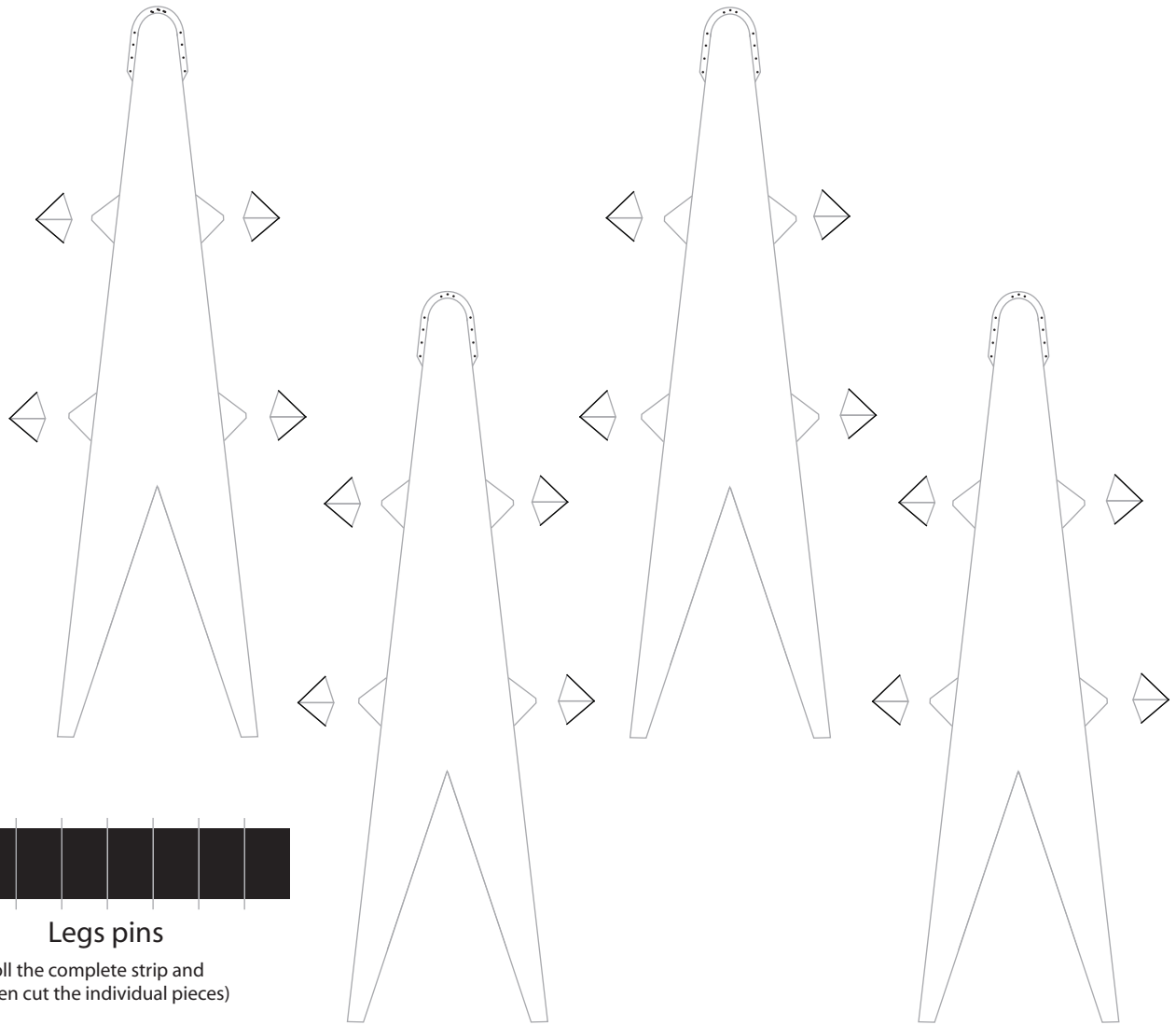

Legs pins

(roll the complete strip and then cut the individual pieces)

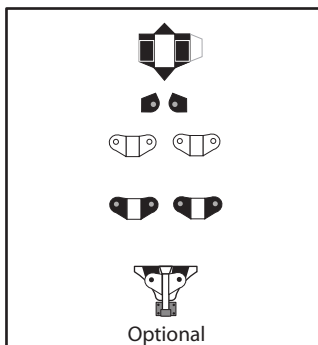

Optional

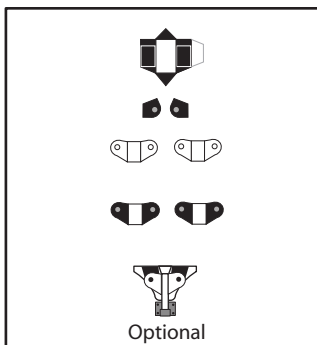

Optional

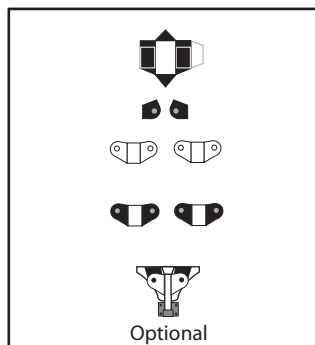

Optional

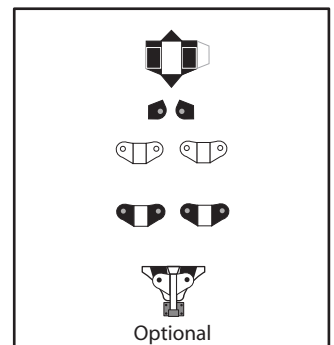

Optional



1:100 Scale



SPACE-X "Falcon-9 v1.2"

MERLIN Engines

Print on Cardstock (110 lbs)

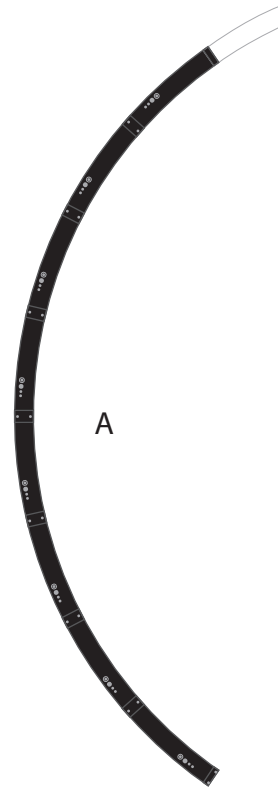
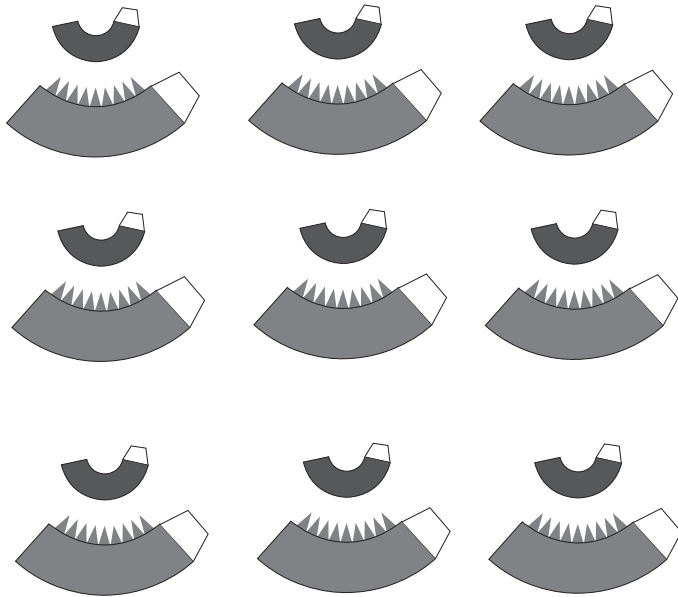

C

B

A

D

C

B

A

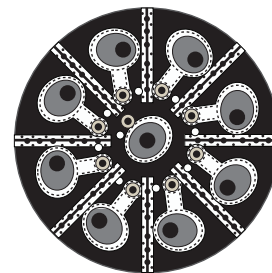
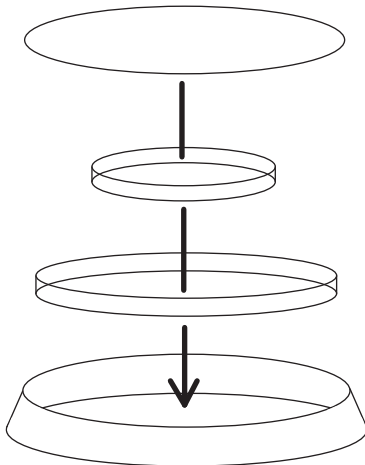

D

Engine Grid
OCTAWEB