



# SPACE-X "Dragon 2 Cargo"

## Launch Configuration

Print on Cardstock (90 lbs)

Revised

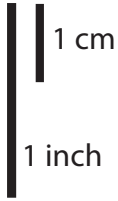

### 1:100 Scale

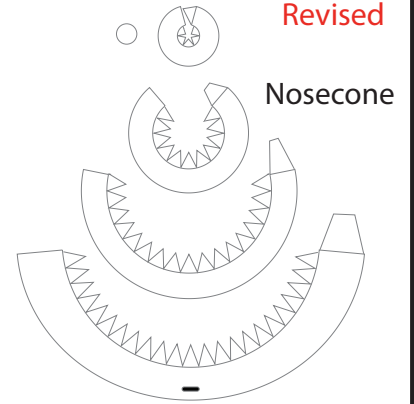

Nosecone

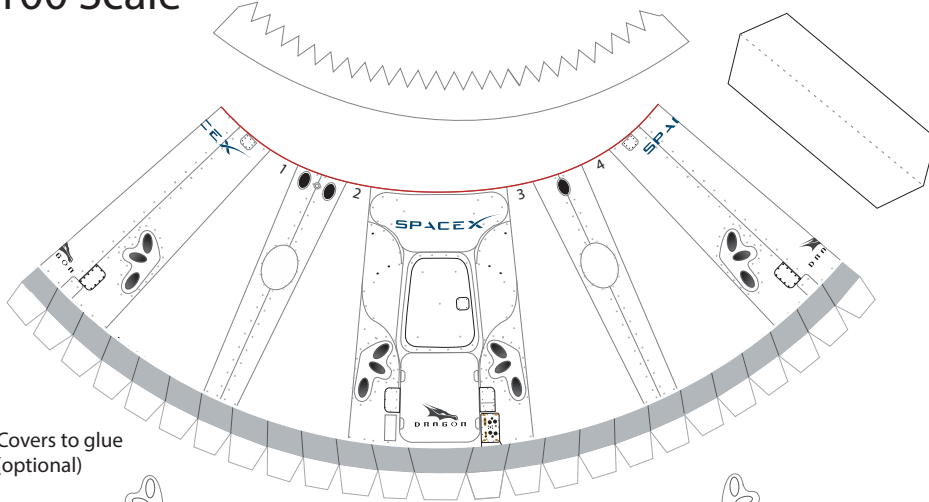

Nozzle Covers to glue on top (optional)

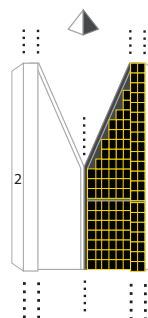
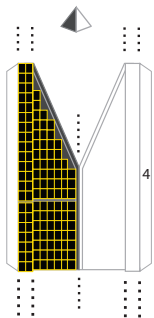
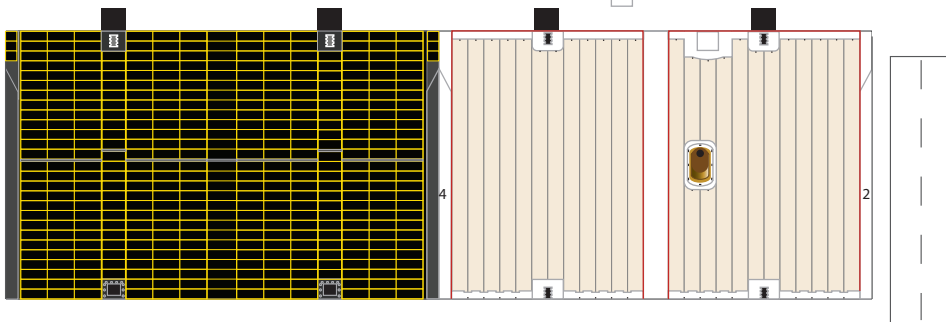
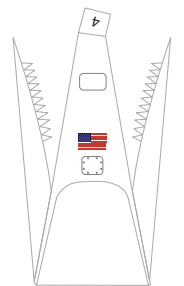
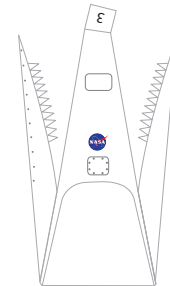
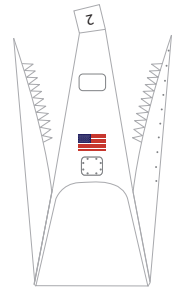
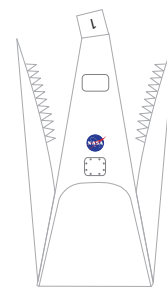
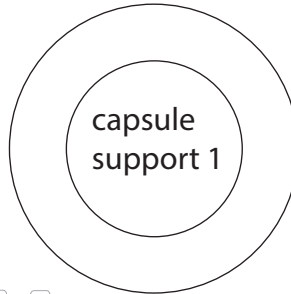
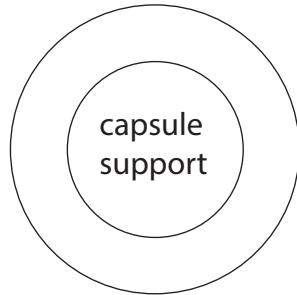
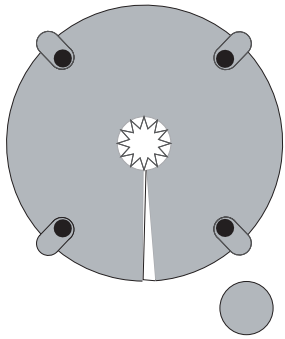



# SPACE-X "Falcon 9 Block 5"

Print on Cardstock (110 lbs)

1 cm

1 inch

## Dragon 2 Cargo CRS-21



Crew Dragon 2 connector

### 1:100 Scale



# FALCON 9

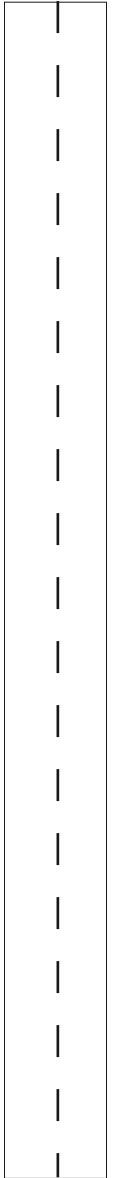
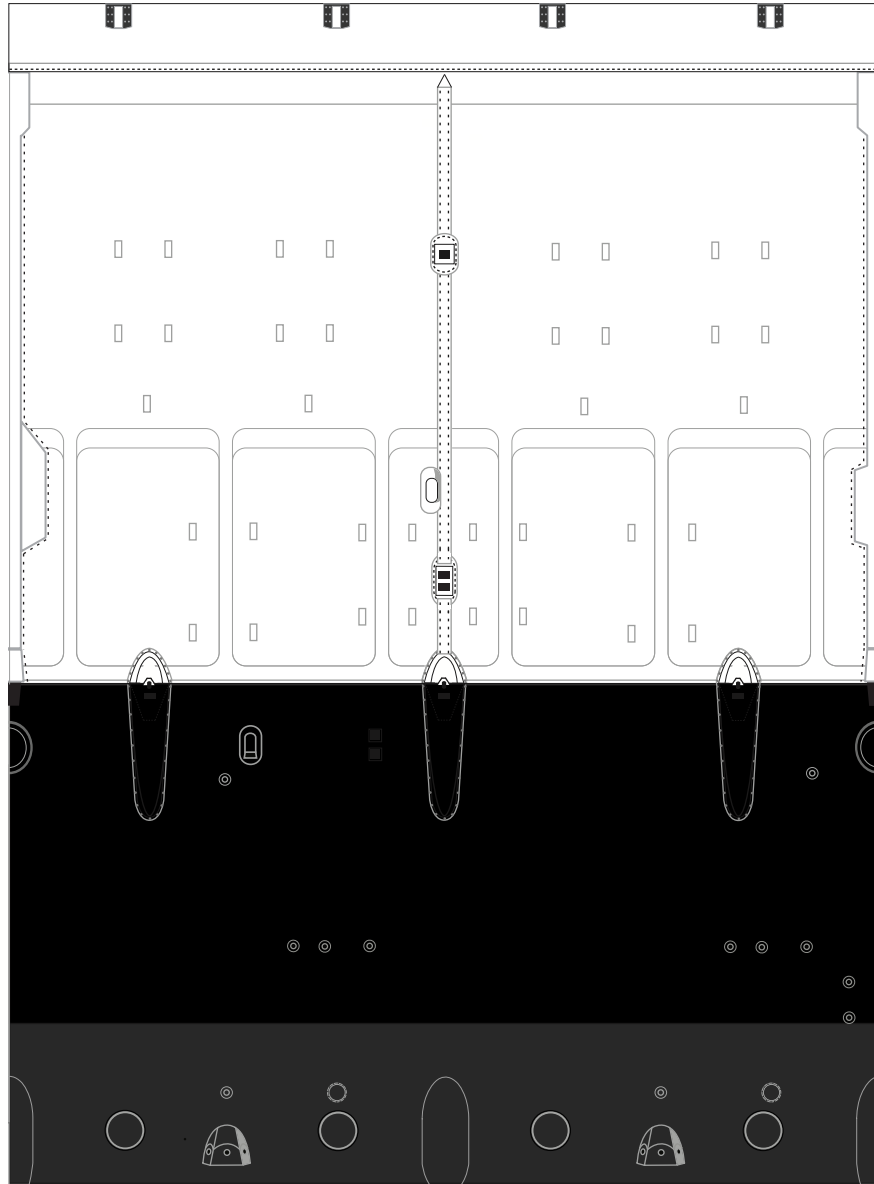
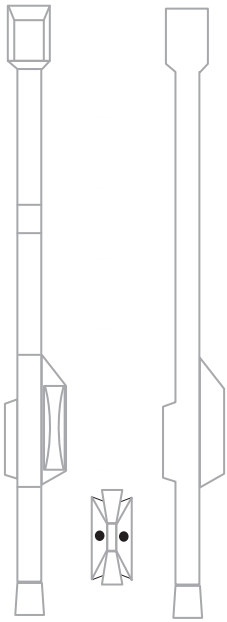

### Titanium Grid Fins

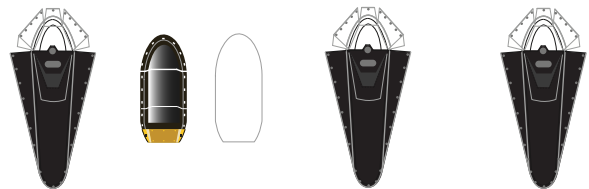
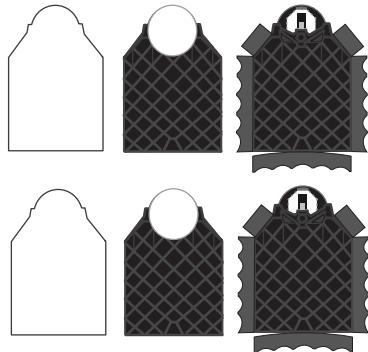
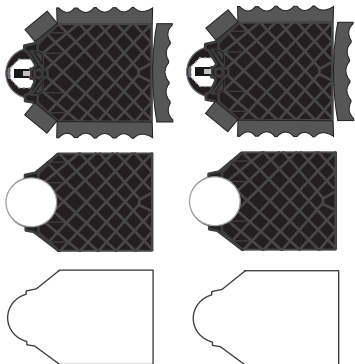



1:100 Scale



# SPACE-X "Falcon 9 Block 5"

Print on Cardstock (110 lbs)  
CRS-21 **Block 5**

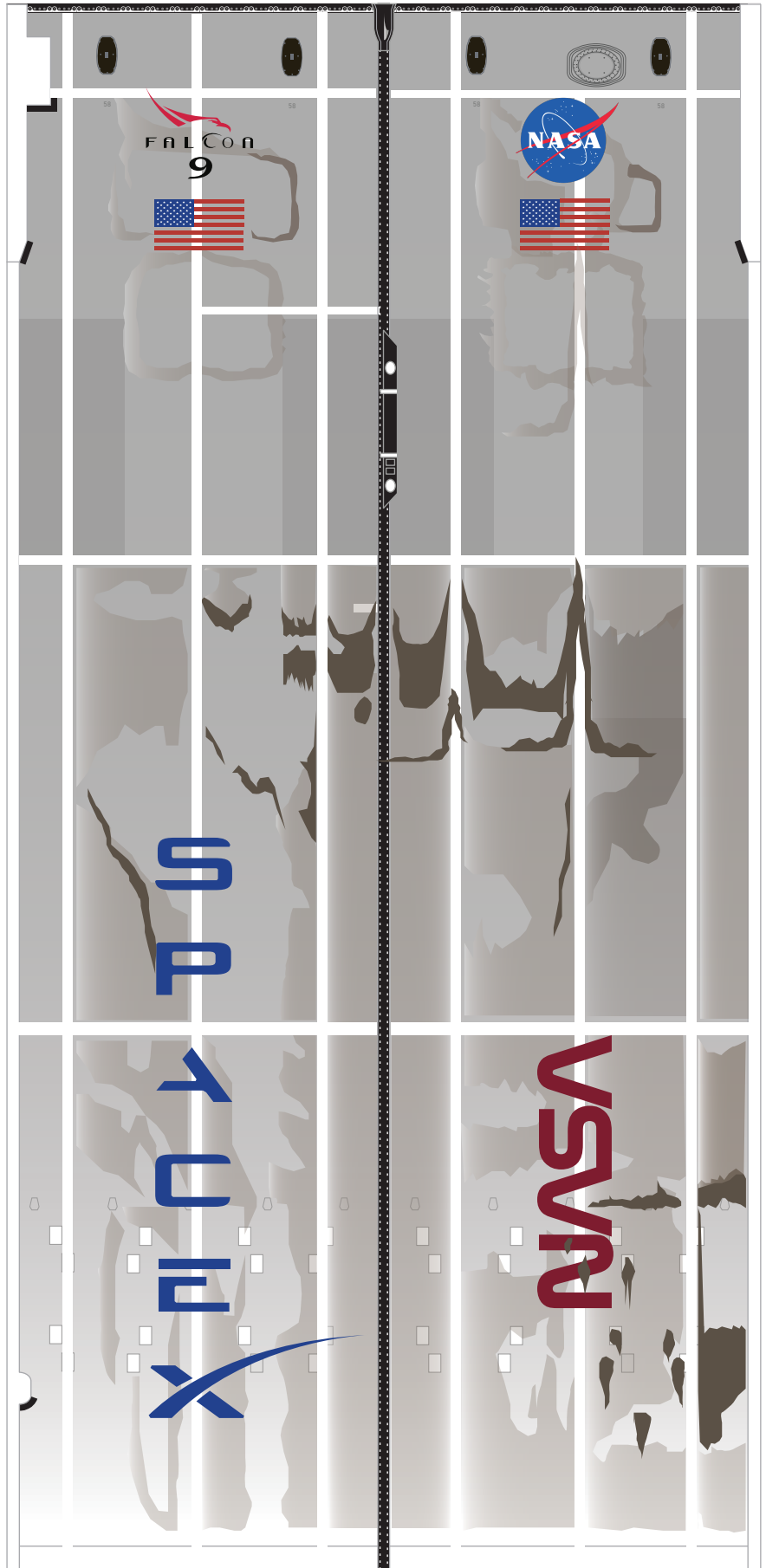



1:100 Scale



# SPACE-X "Falcon 9 Block 5"

Print on Cardstock (110 lbs)

Rev. 1  
Block 5

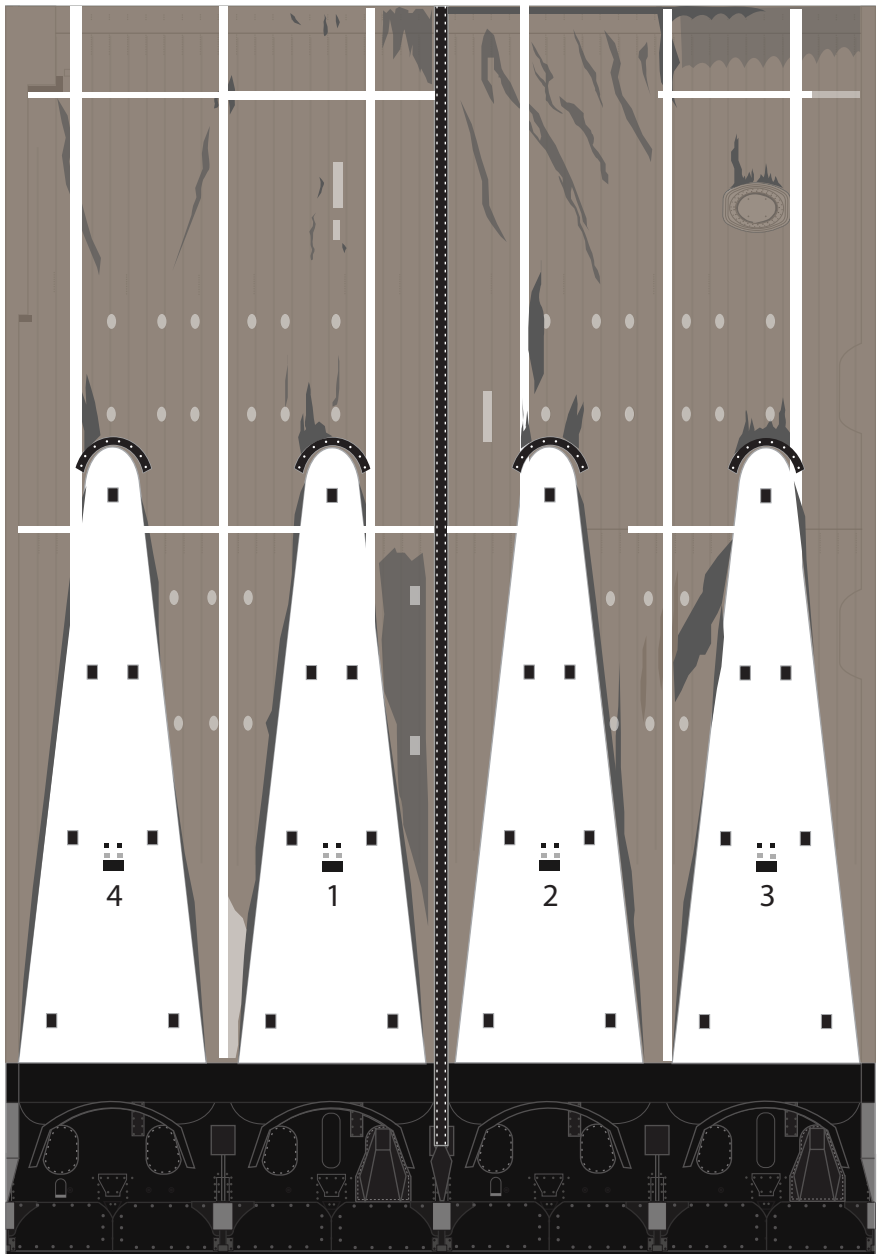
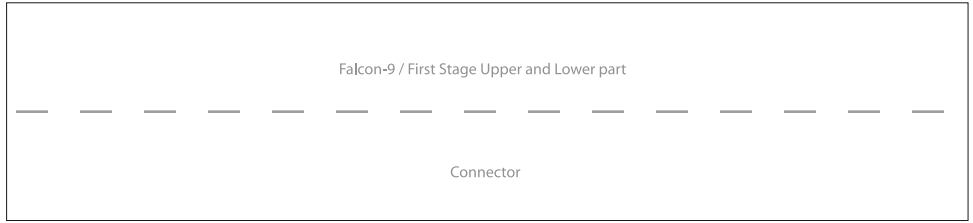



1:100 Scale



# SPACE-X "Falcon 9 Block 5"

Print on Cardstock (110 lbs)

BLOCK 5

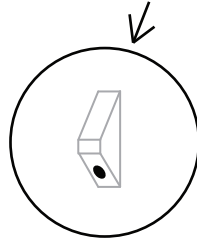

Thicker Raceway





# SPACE-X "Falcon-9 Block 5"

Print on Cardstock (110 lbs)



## LEGS 2.0

1:100 Scale

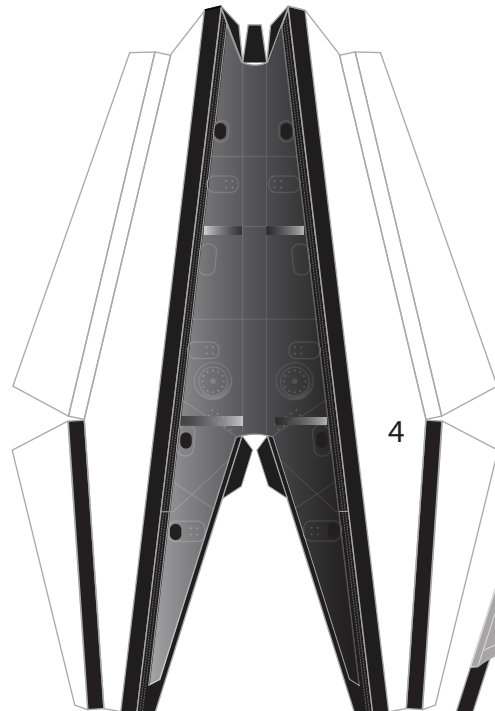
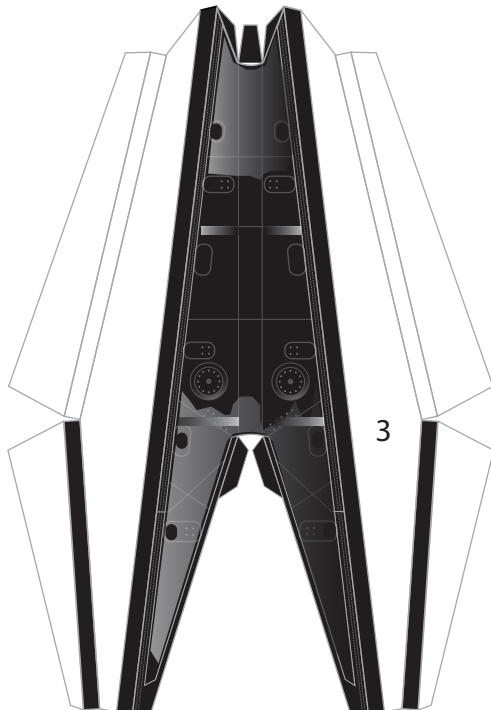
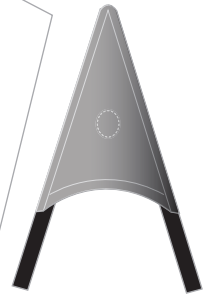
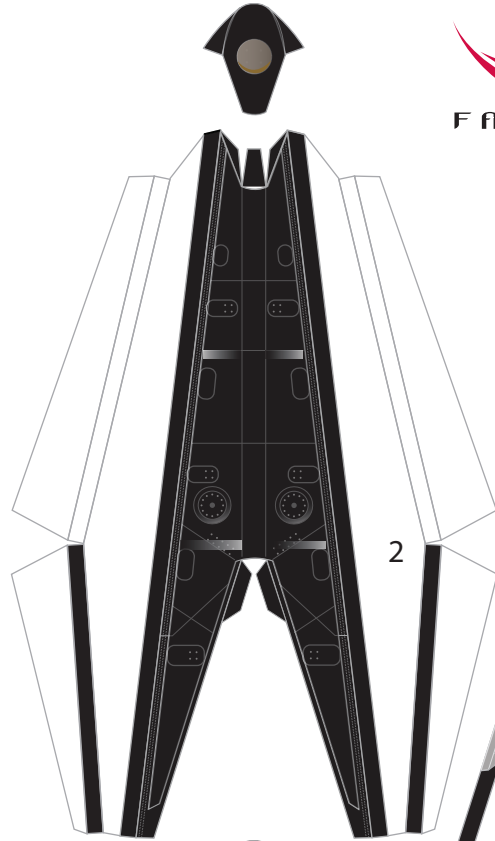
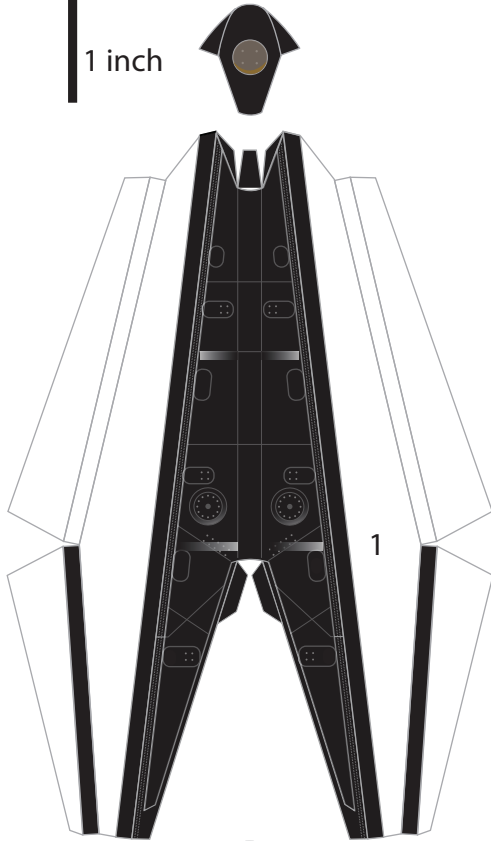
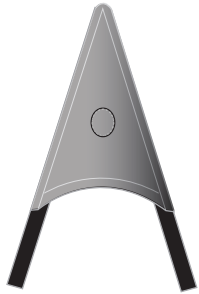



# SPACE-X "Falcon 9 Block 5"

Print on Cardstock (110 lbs)



LEGS 2.0 page 2

Rev. 2



1:100 Scale

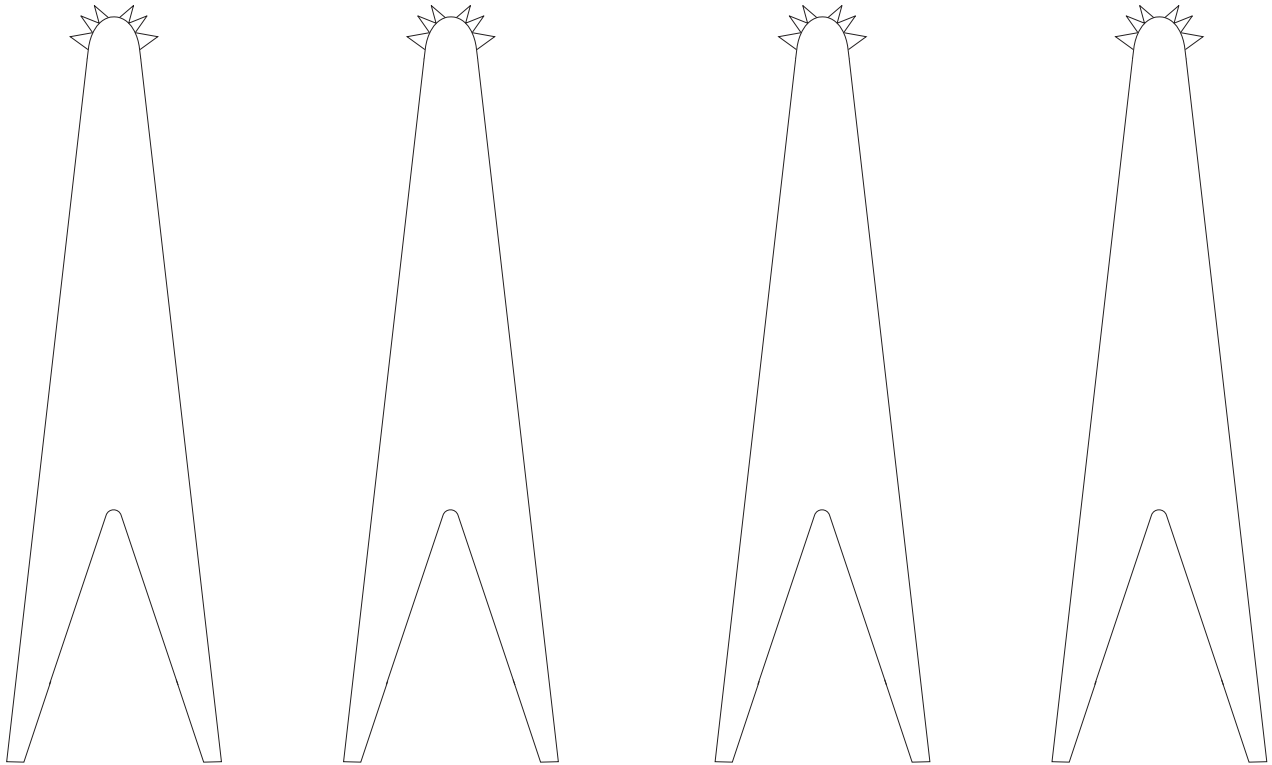

Legs pins

(roll the complete strip and then cut the individual pieces)

## New Leg Hinges

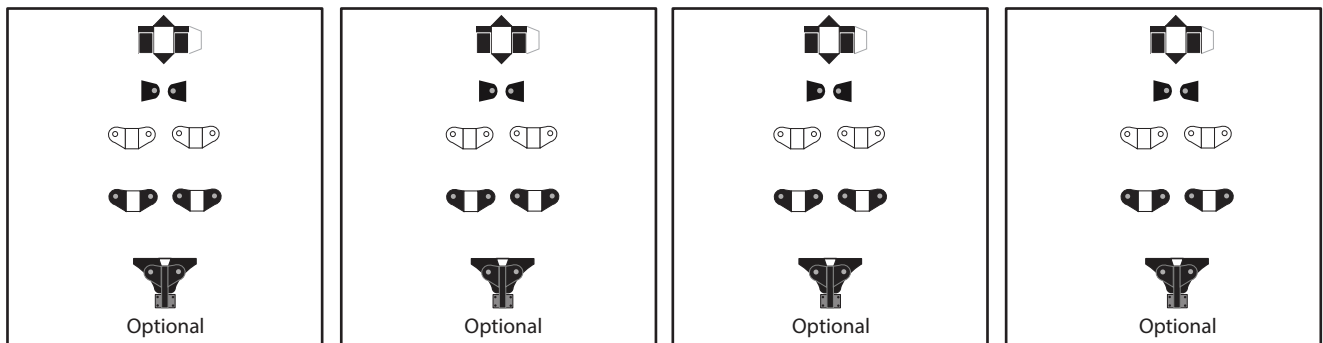



# SPACE-X Falcon 9 Octaweb

Print on Cardstock (110 lbs)

## MERLIN Engines

1:100 Scale

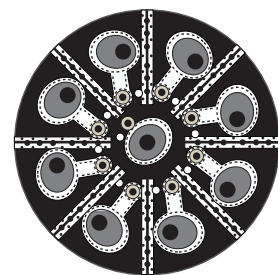
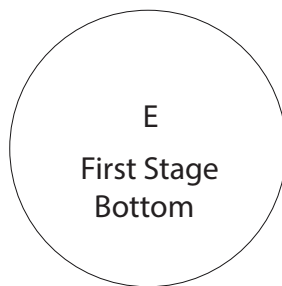
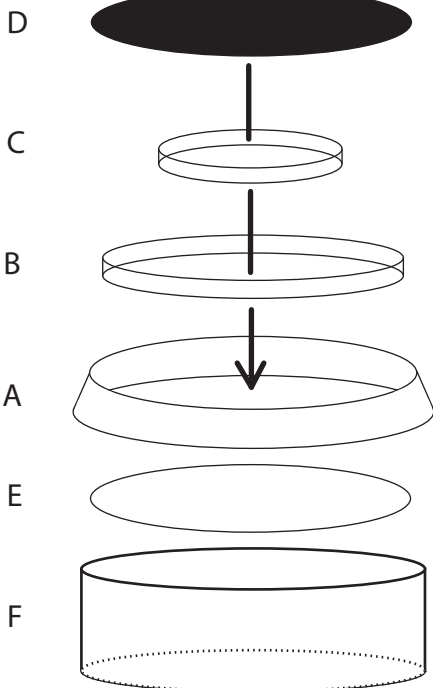
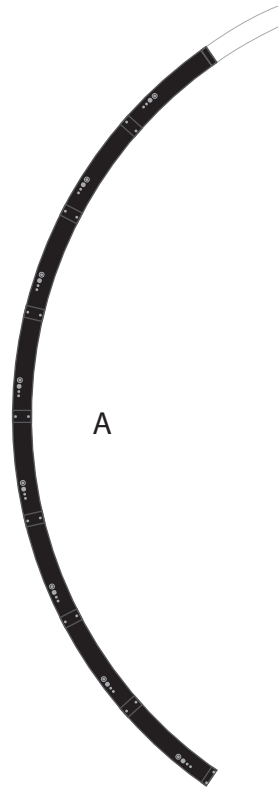
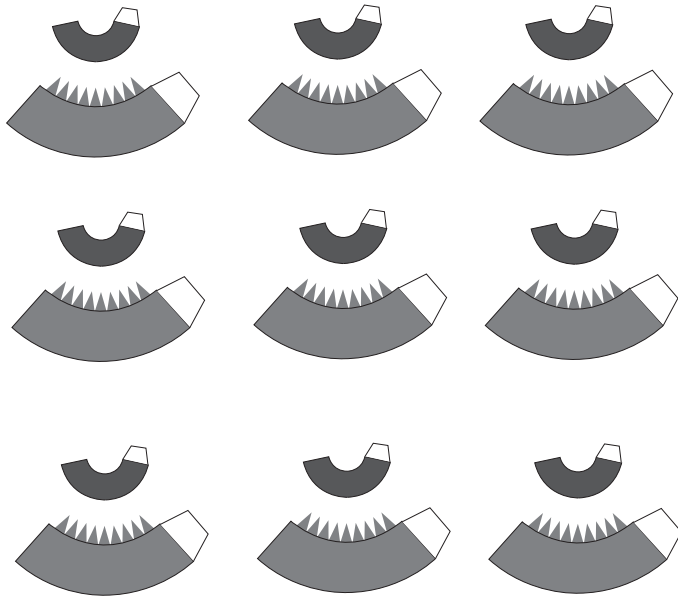

Engine Grid  
OCTAWEB

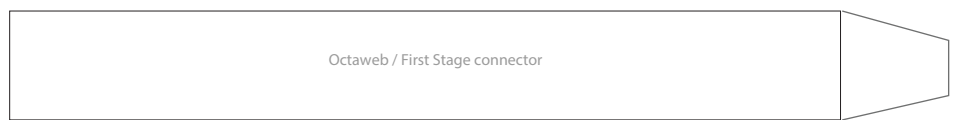





1:100 Scale

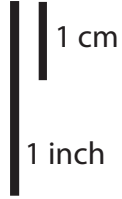

SPACE-X "Falcon 9 Block 5"

Print on Cardstock (110 lbs)

MERLIN Engines

BACK PRINT

