



SPACE-X "Crew Dragon 2" Crew-2 Capsule Launch Configuration

Print on Cardstock (90 lbs)

Revised

Nosecone

1:100 Scale

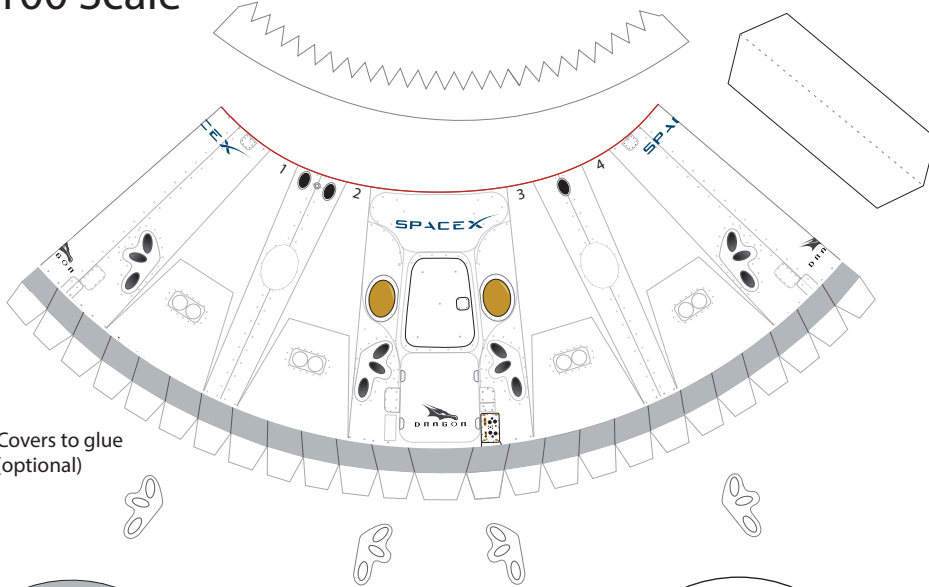
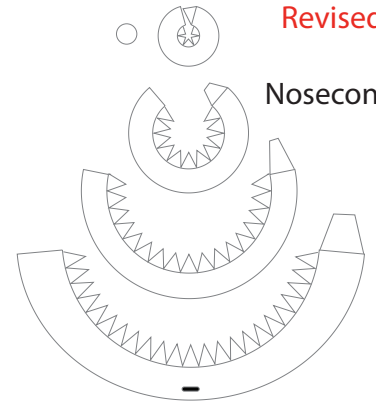

Nozzle Covers to glue on top (optional)

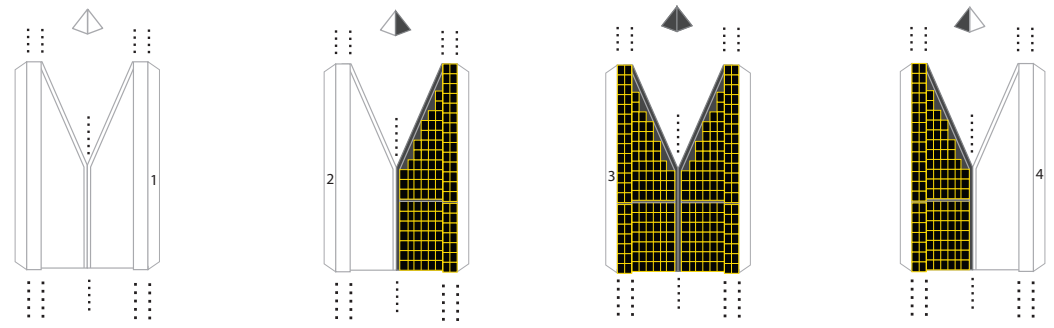
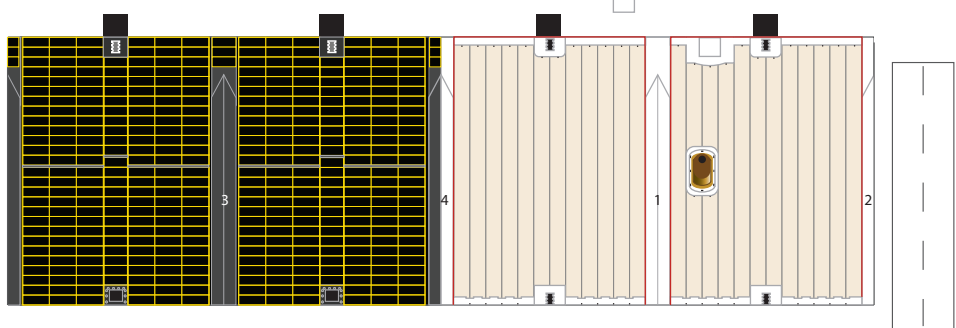
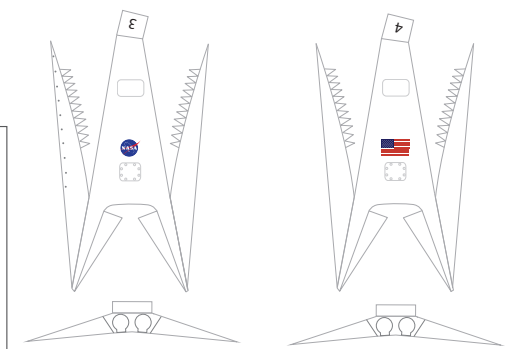
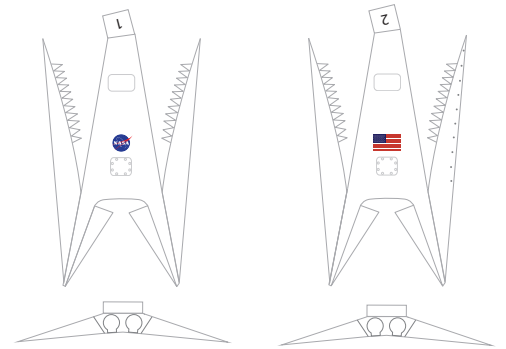
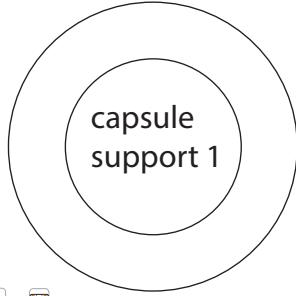
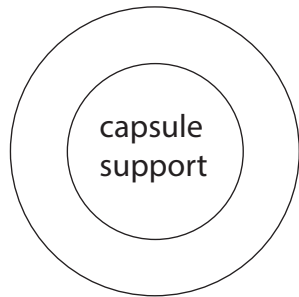
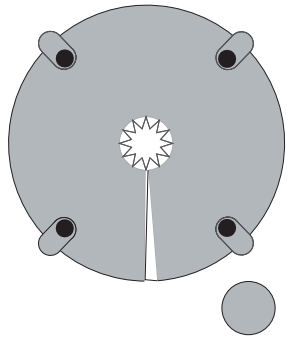



SPACE-X "Falcon 9 Block 5"

Print on Cardstock (110 lbs)

1 cm

1 inch

Use for Crew Dragon 2



1:100 Scale

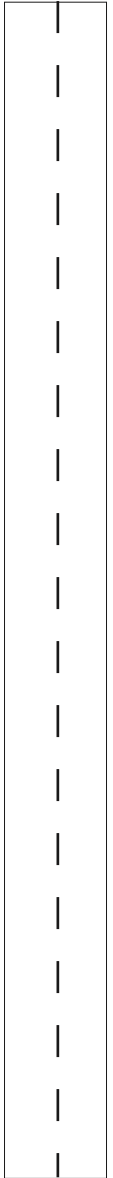
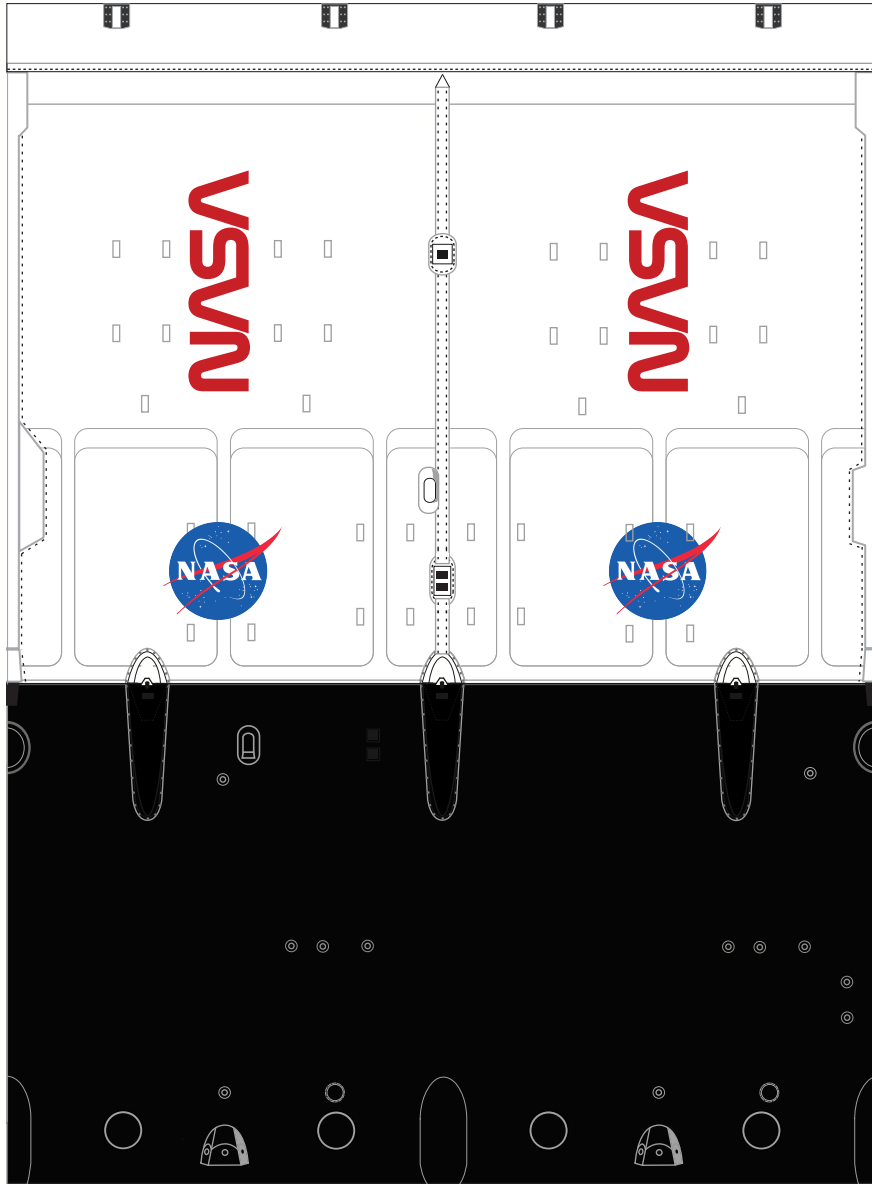
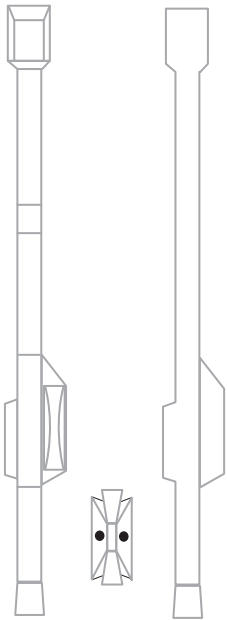

Titanium Grid Fins

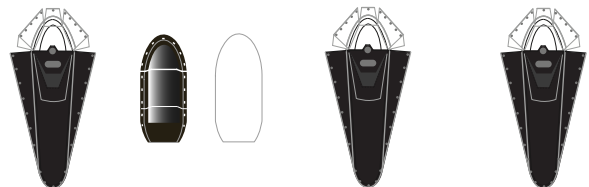
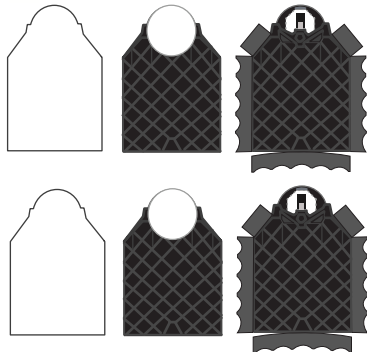
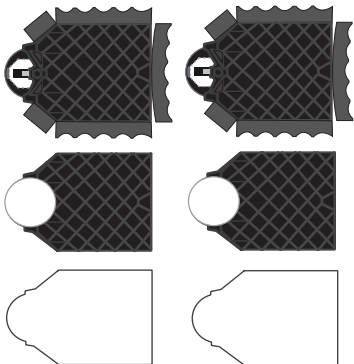



1:100 Scale



Falcon-9/ Interstage - First Stage

Connector

SPACE-X "Falcon 9 Block 5"

Print on Cardstock (110 lbs)

Block 5

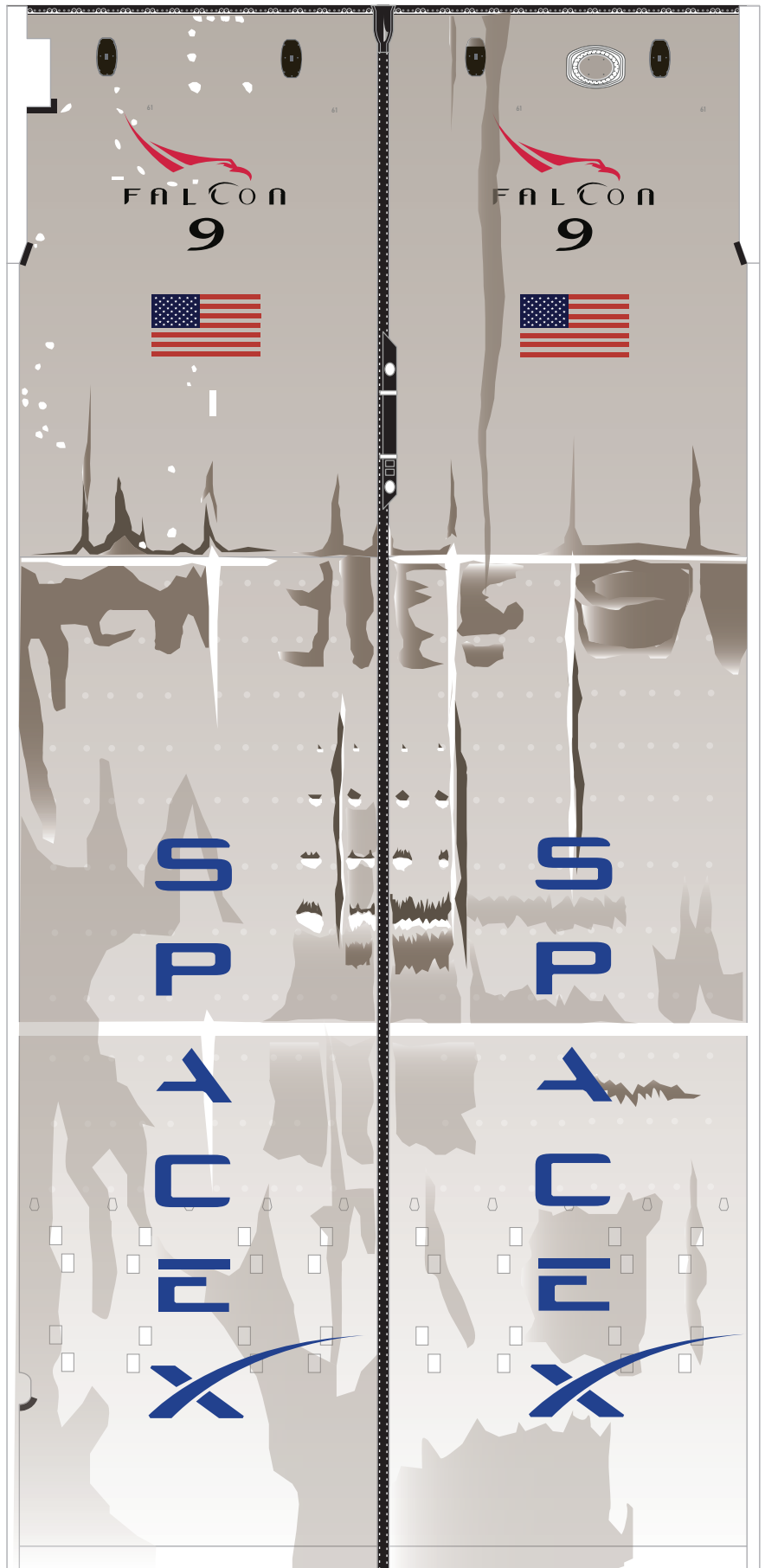
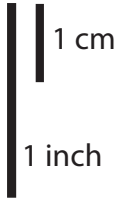



1:100 Scale



SPACE-X "Falcon 9 Block 5"

Print on Cardstock (110 lbs)

Rev. 1
Block 5

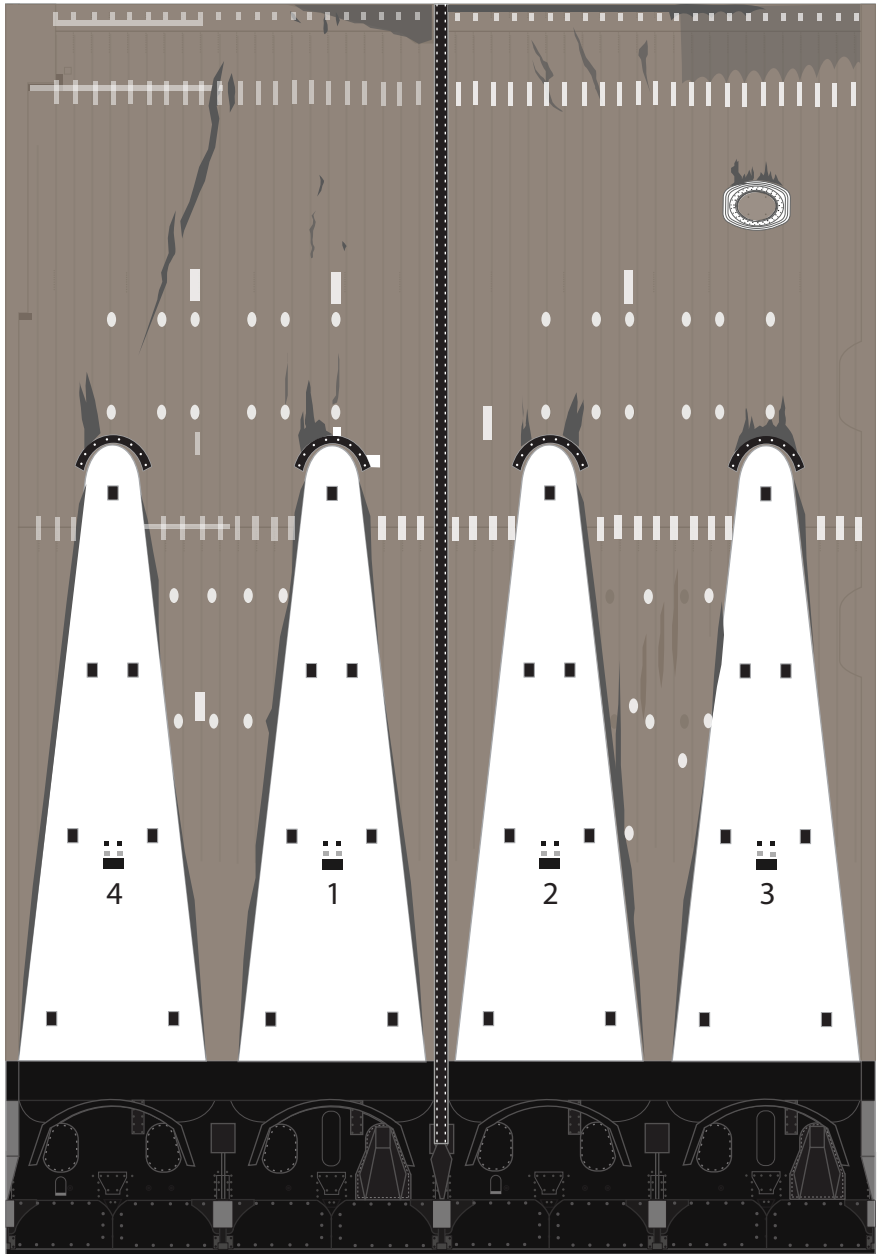
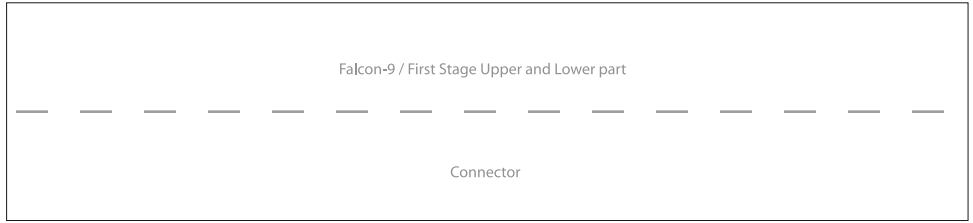



1:100 Scale



SPACE-X "Falcon 9 Block 5"

Print on Cardstock (110 lbs)

BLOCK 5

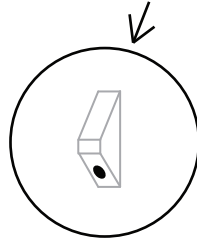

Thicker Raceway



bottom



SPACE-X "Falcon-9 Block 5"

Print on Cardstock (110 lbs)



LEGS 2.0

1:100 Scale

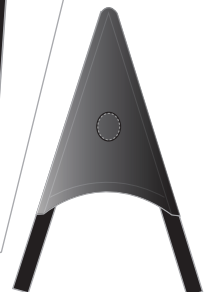
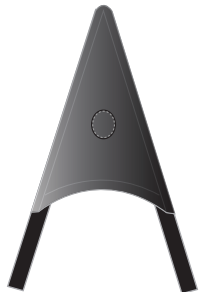
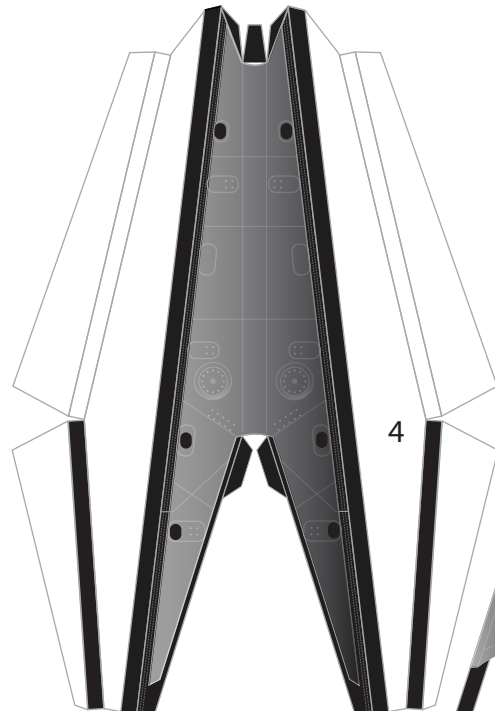
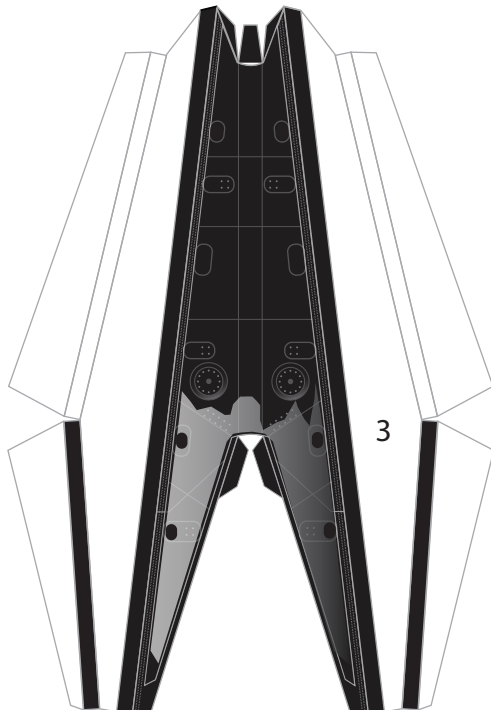
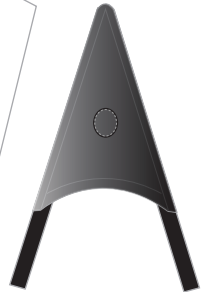
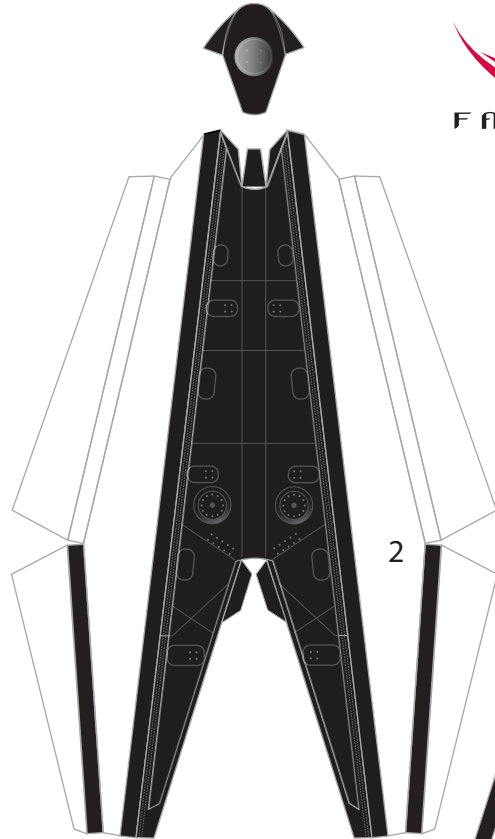
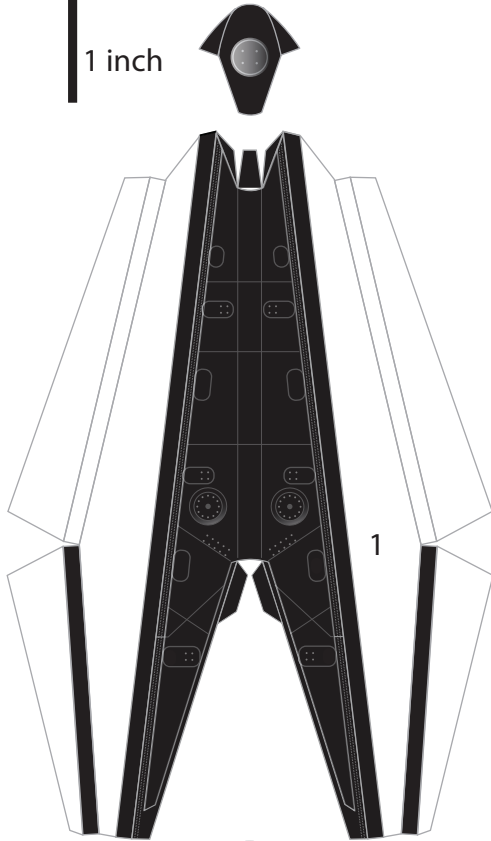



SPACE-X "Falcon 9 Block 5"

Print on Cardstock (110 lbs)

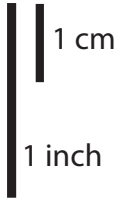

LEGS 2.0 page 2

Rev. 2



1:100 Scale

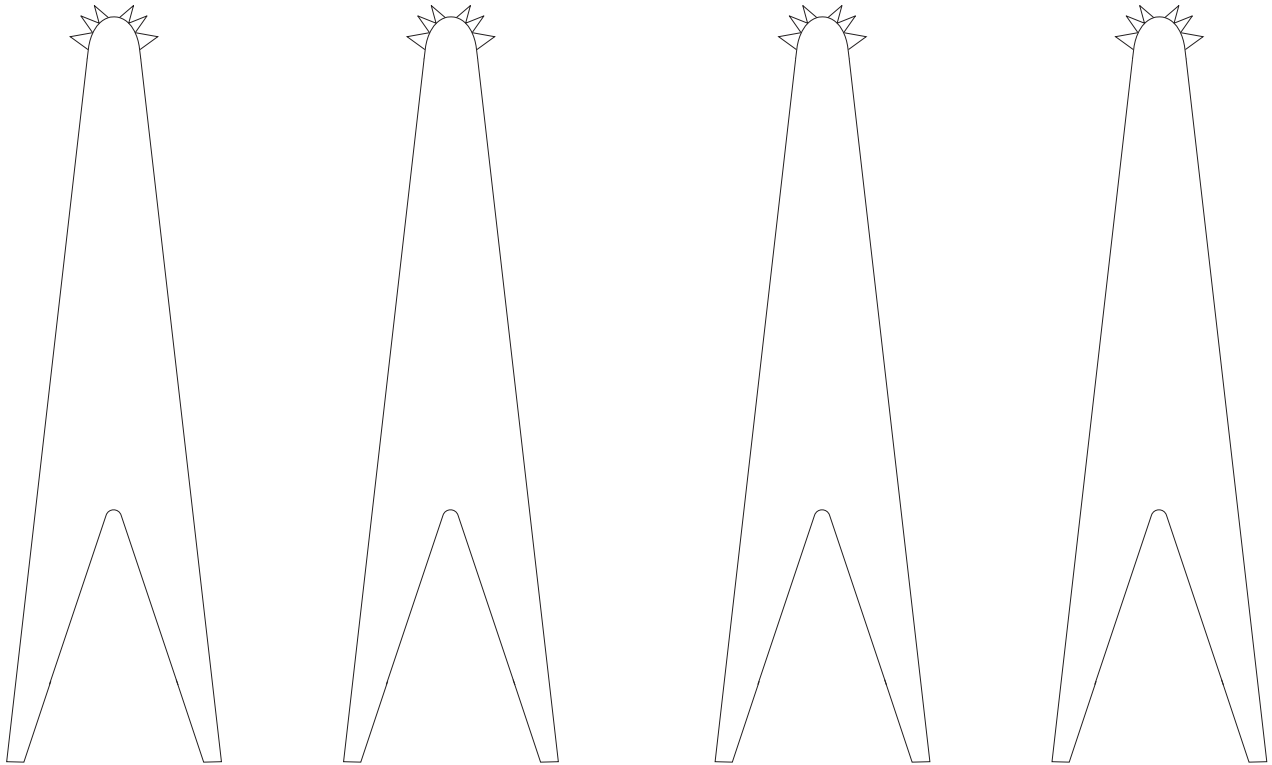

Legs pins

(roll the complete strip and then cut the individual pieces)

New Leg Hinges

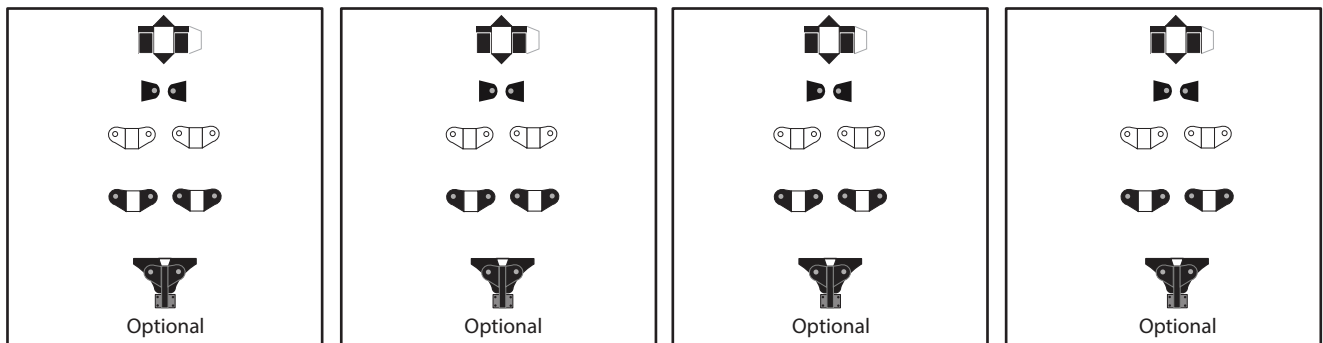



SPACE-X Falcon 9 Octaweb

Print on Cardstock (110 lbs)

MERLIN Engines

1:100 Scale

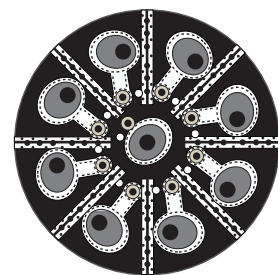
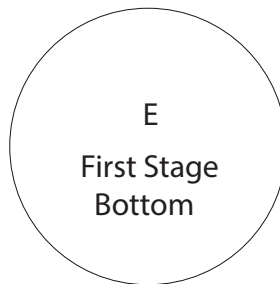
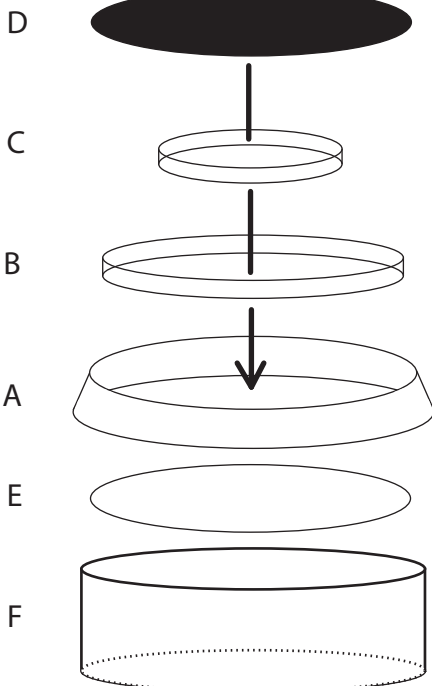
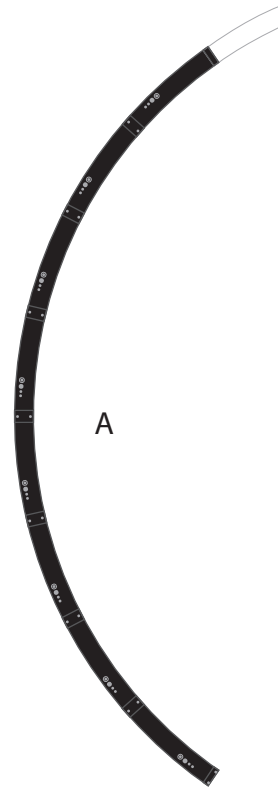
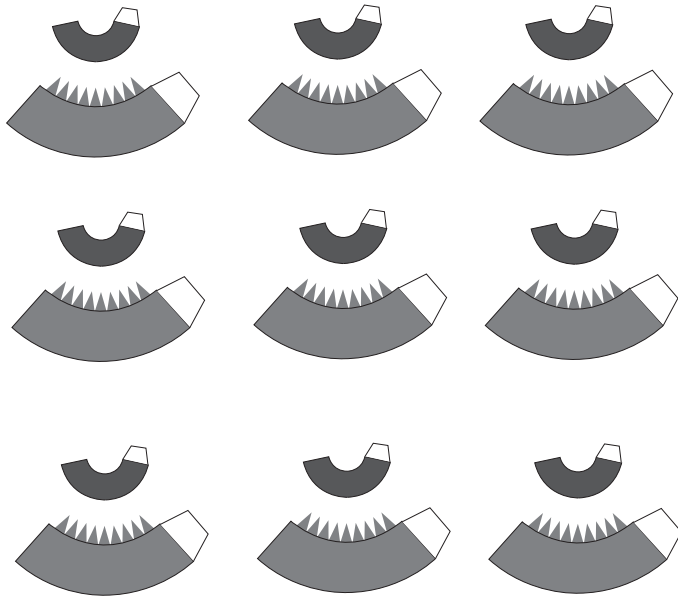

Engine Grid
OCTAWEB

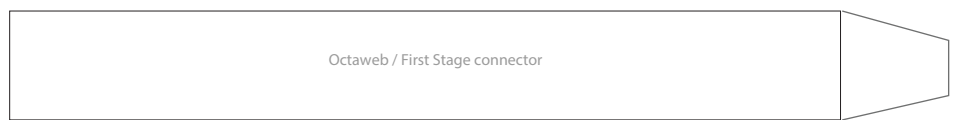



1:100 Scale

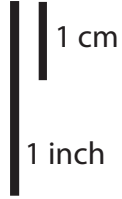

SPACE-X "Falcon 9 Block 5"

Print on Cardstock (110 lbs)

MERLIN Engines

BACK PRINT

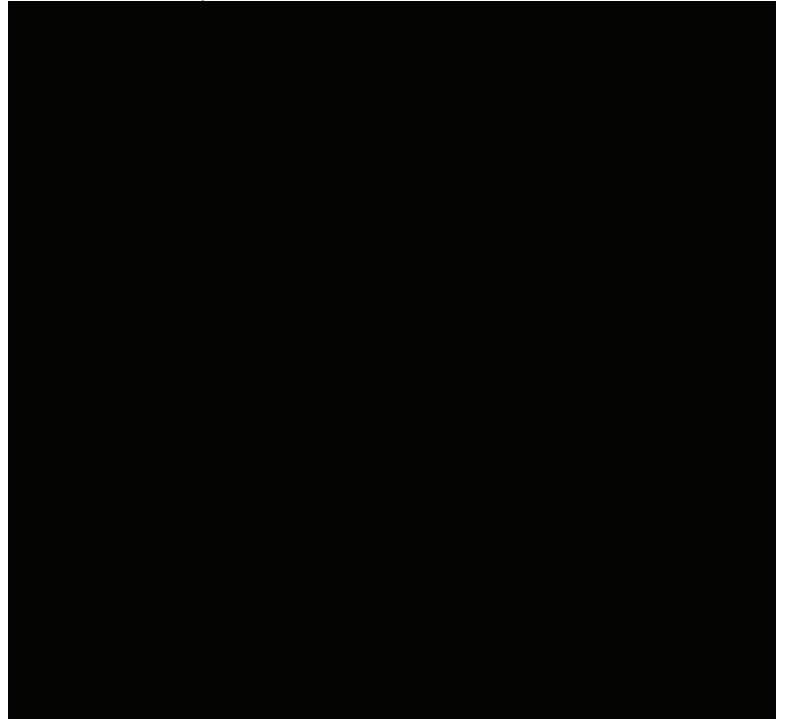



1:100 Scale

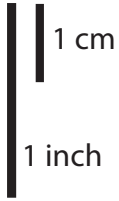

SPACE-X "Crew Dragon 2" Crew-2 Capsule Docking Configuration

Print on Cardstock (90 lbs)

Revised

Nosecone

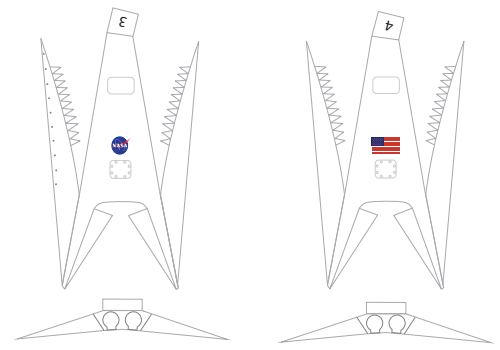
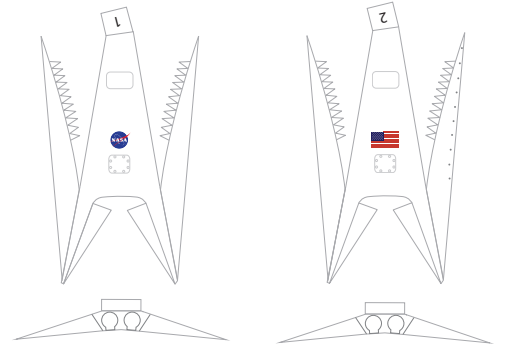
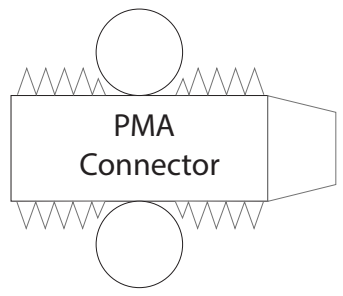
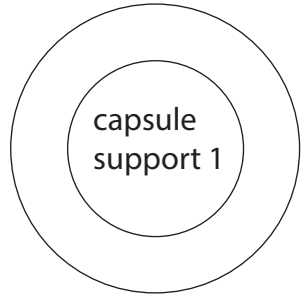
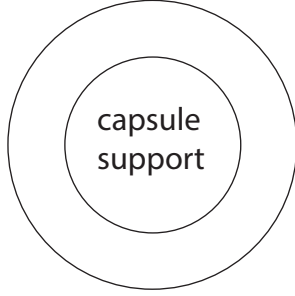
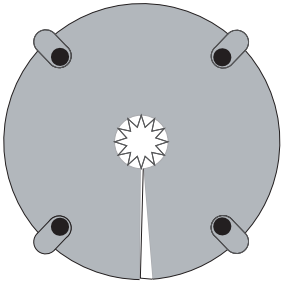
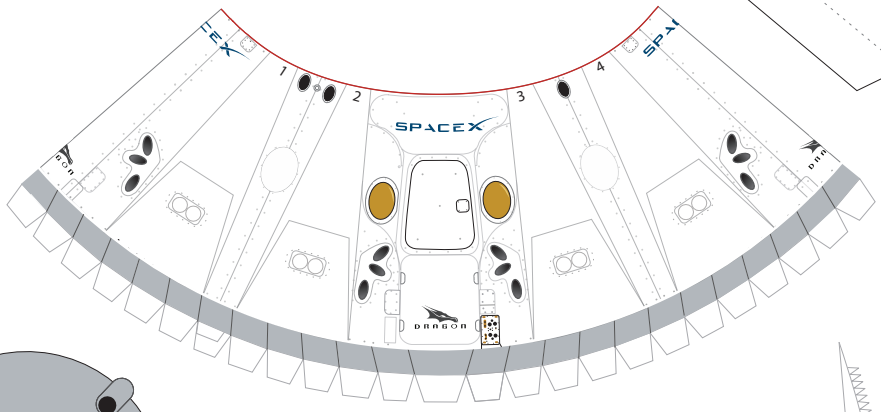
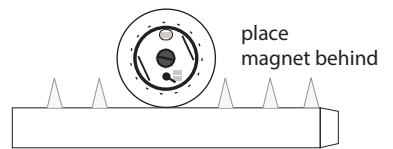
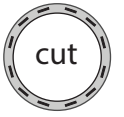
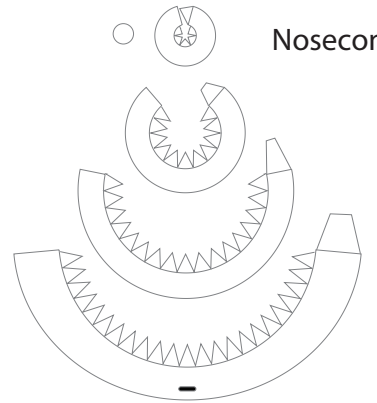
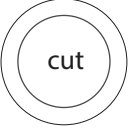
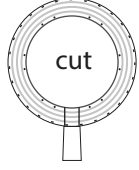
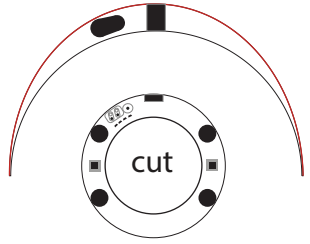



SPACE-X "Crew Dragon 2" Crew-2 Capsule

Print on Cardstock (90 lbs)



1:100 Scale

Detailed trunk

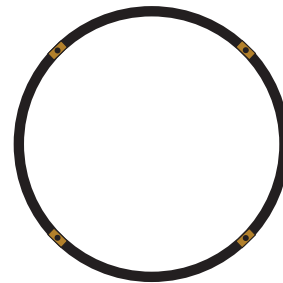
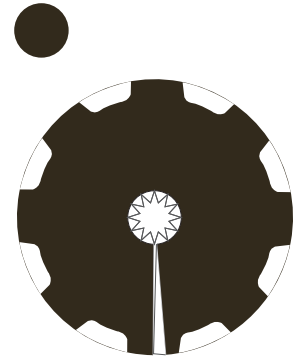
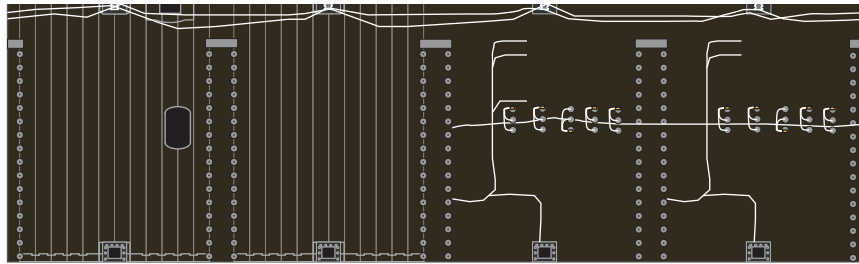
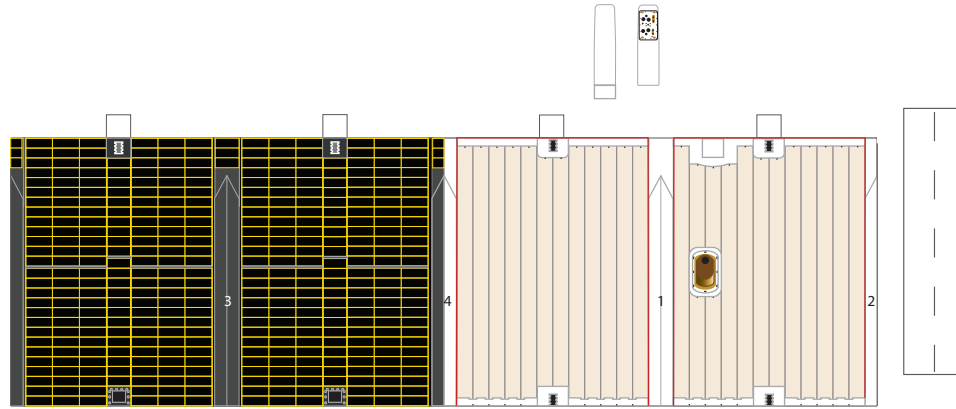

Do not include this ring if using second stage diorama

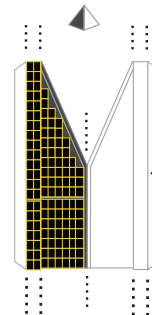
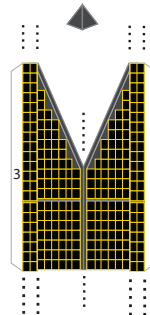
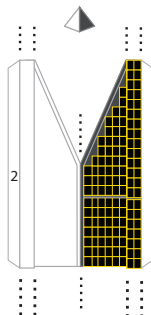
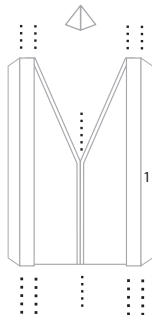



SPACE-X "Falcon 9 Block 5"

Print on Cardstock (110 lbs)

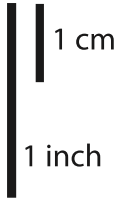

Use Crew Dragon 2 capsule



1:100 Scale

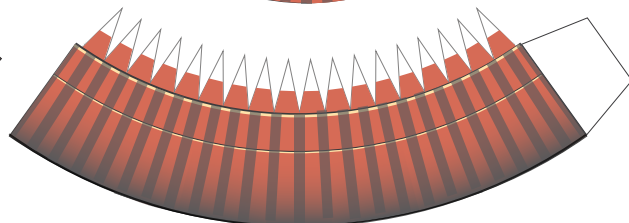
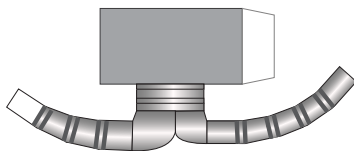
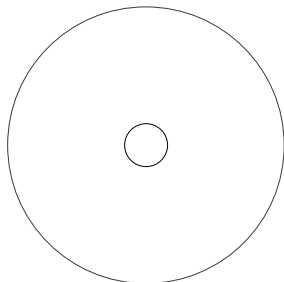
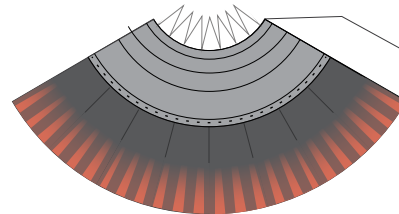
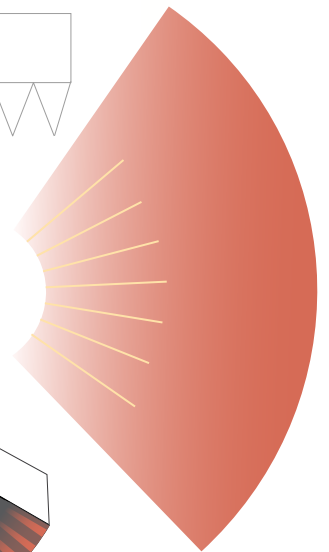
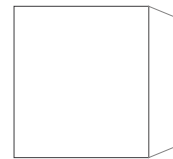
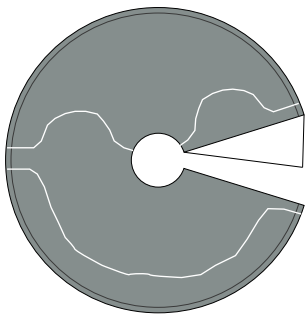
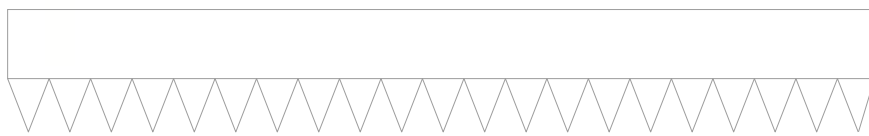
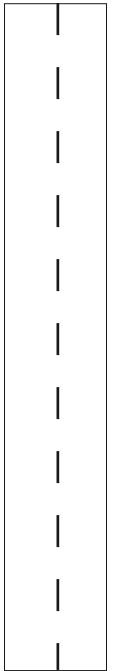
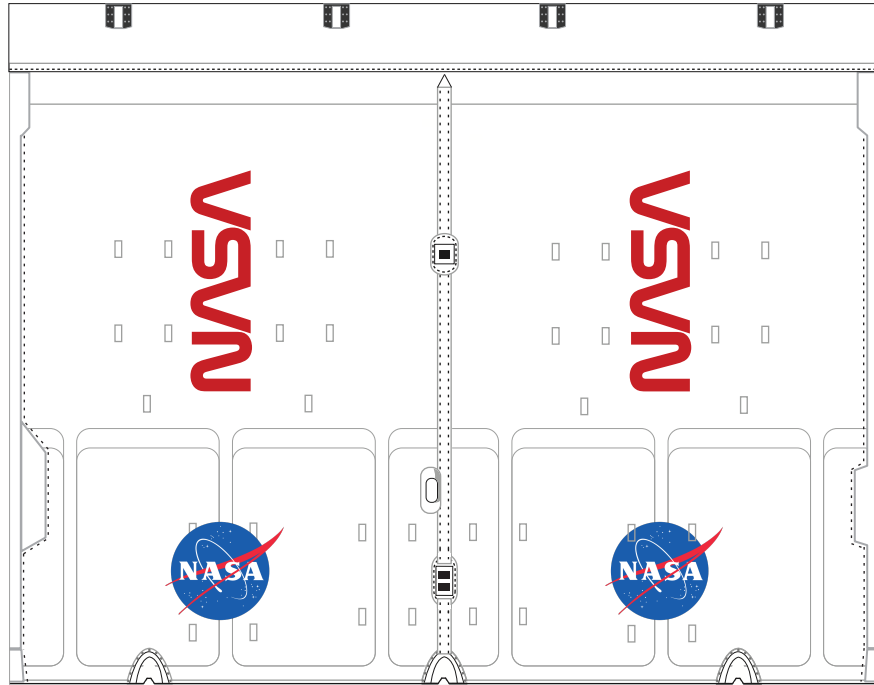
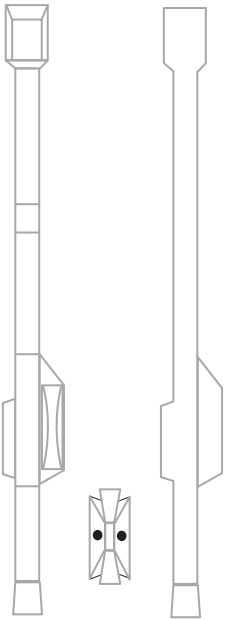



Crew Dragon DM-2 with second stage

Print on Cardstock (110 lbs)



Crew-2 Display stand

Revised

