

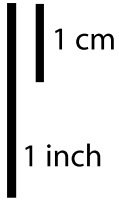

SPACE-X "Falcon 9 Fairing 2.0"

Print on Cardstock (110 lbs)

NROL-108



1:100 Scale

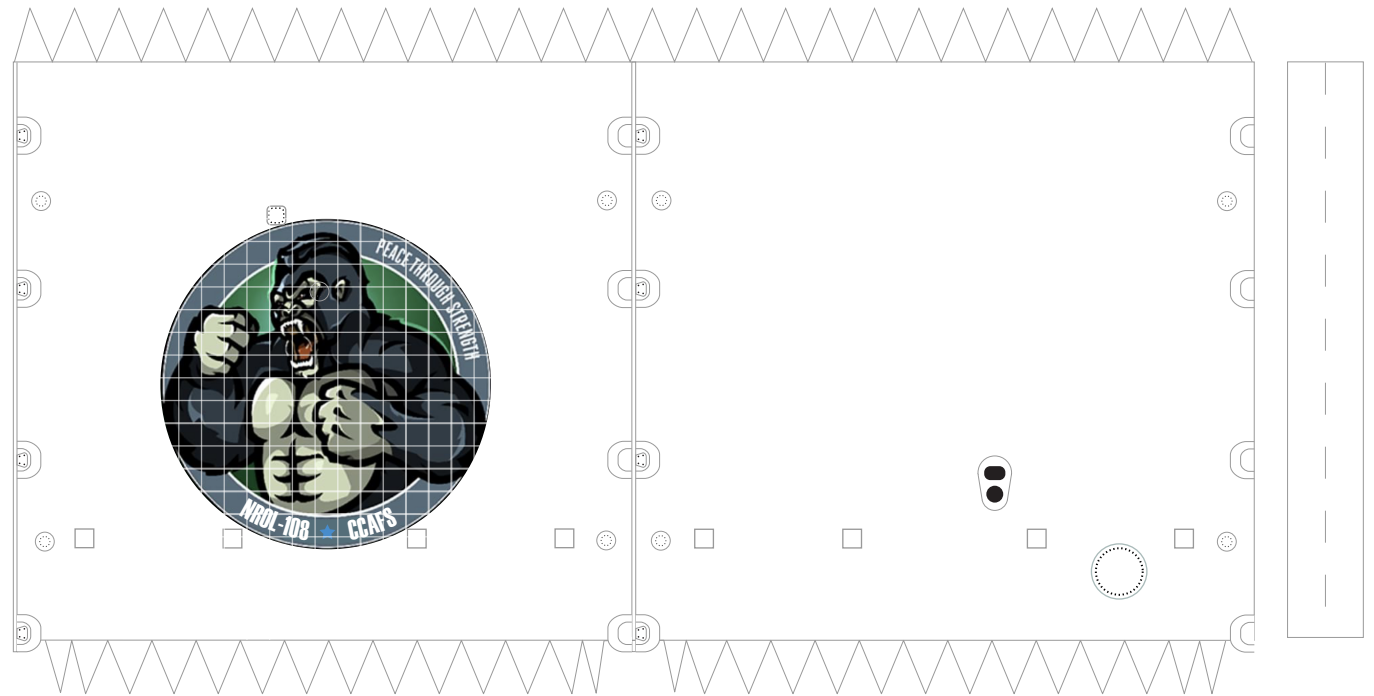
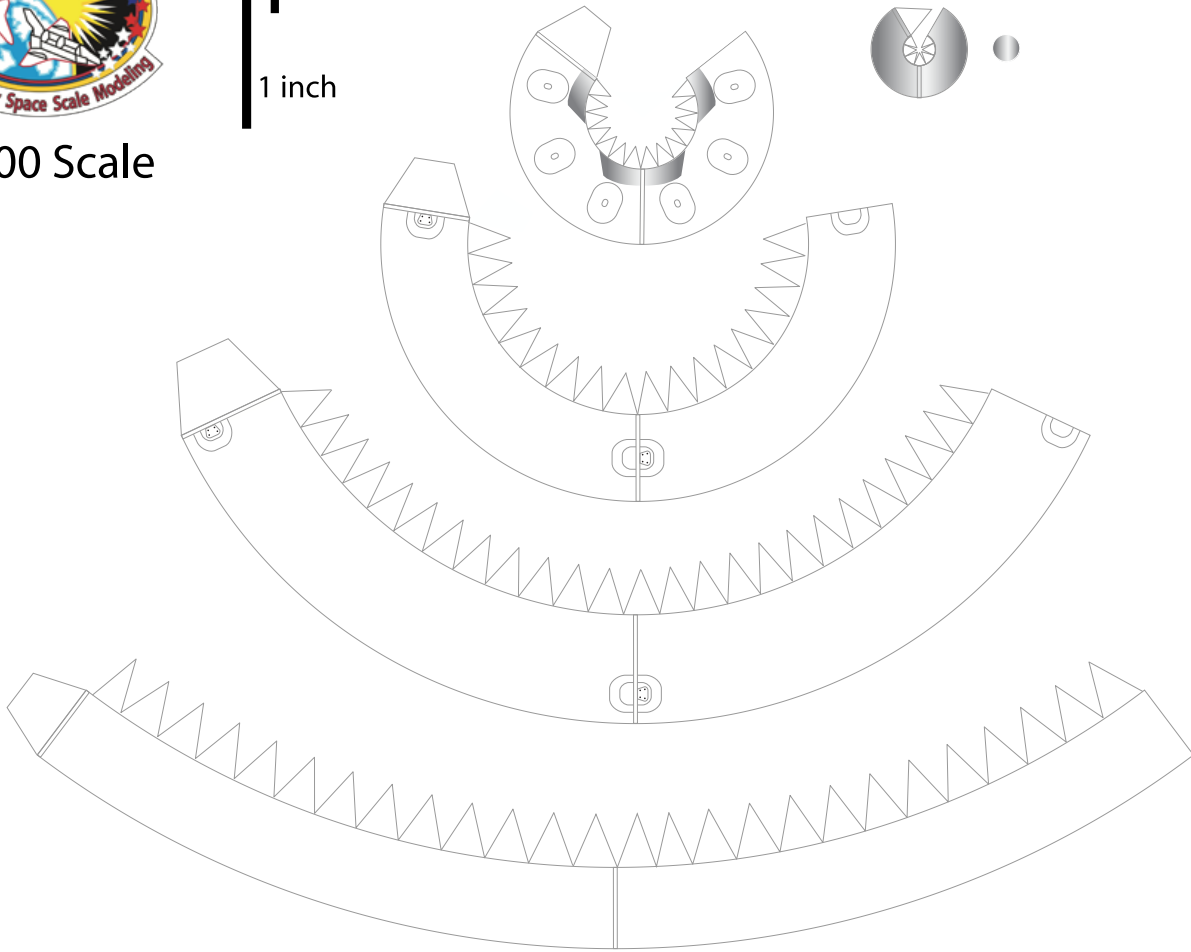



SPACE-X "Falcon 9 Block 5"

Print on Cardstock (110 lbs)

Rev. 3

Enlarged Second Stage / Interstage
Use for Fairing 2.0

Block 5 Second Stage
Titanium Grid Fins

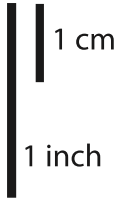

1:100 Scale

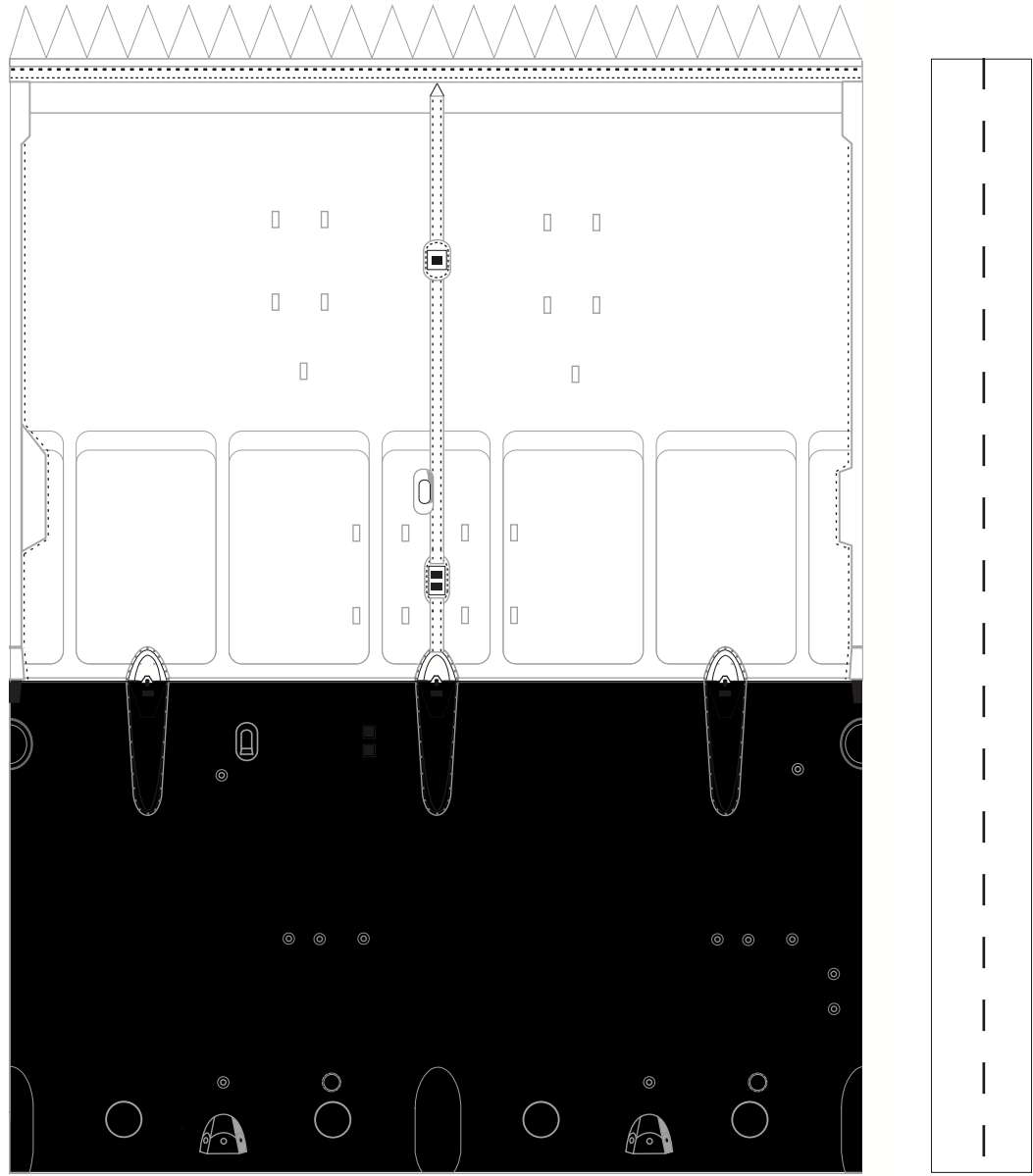
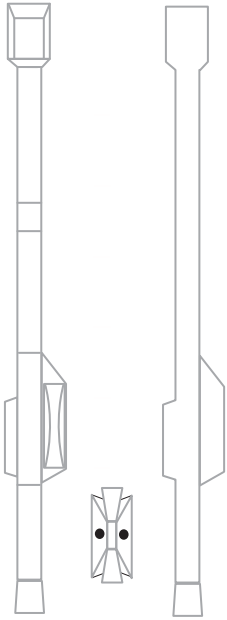

Titanium Grid Fins

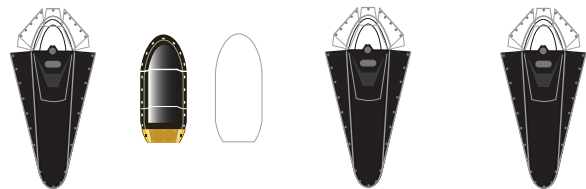
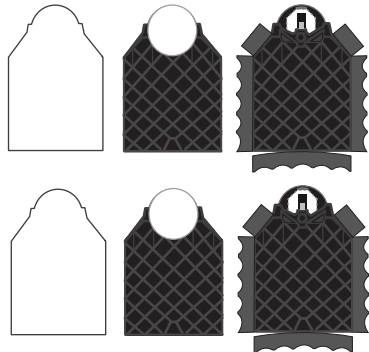
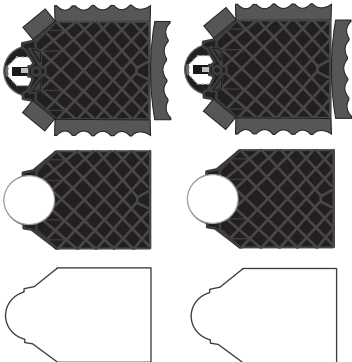



1:100 Scale

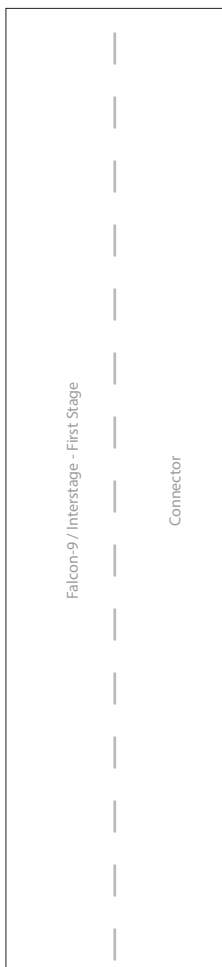

SPACE-X "Falcon 9 Block 5"

Print on Cardstock (110 lbs)

NROL-108

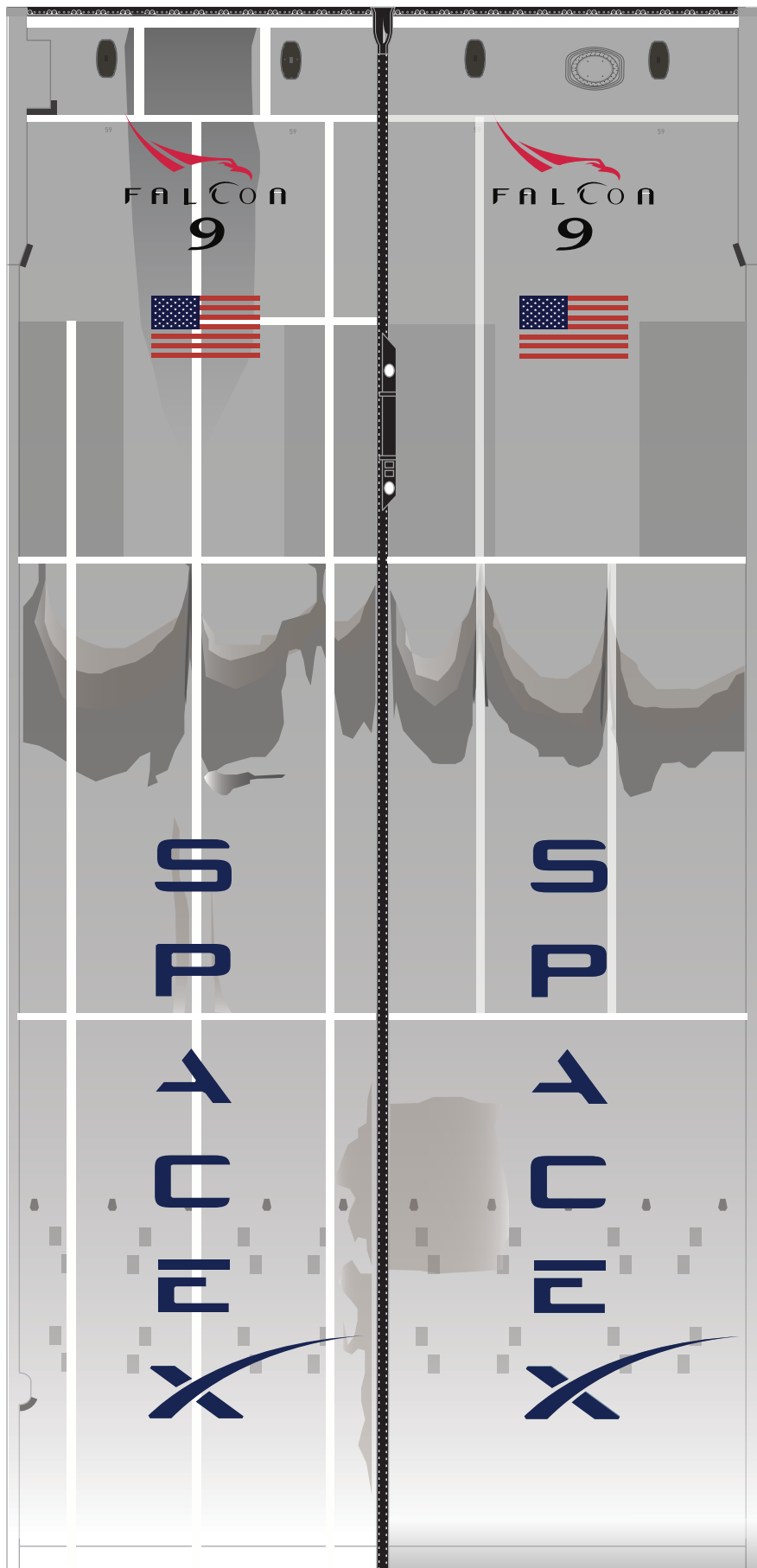



1:100 Scale



FALCON
9

SPACE-X "Falcon 9 Block 5"

Print on Cardstock (110 lbs)

Rev. 1
Block 5

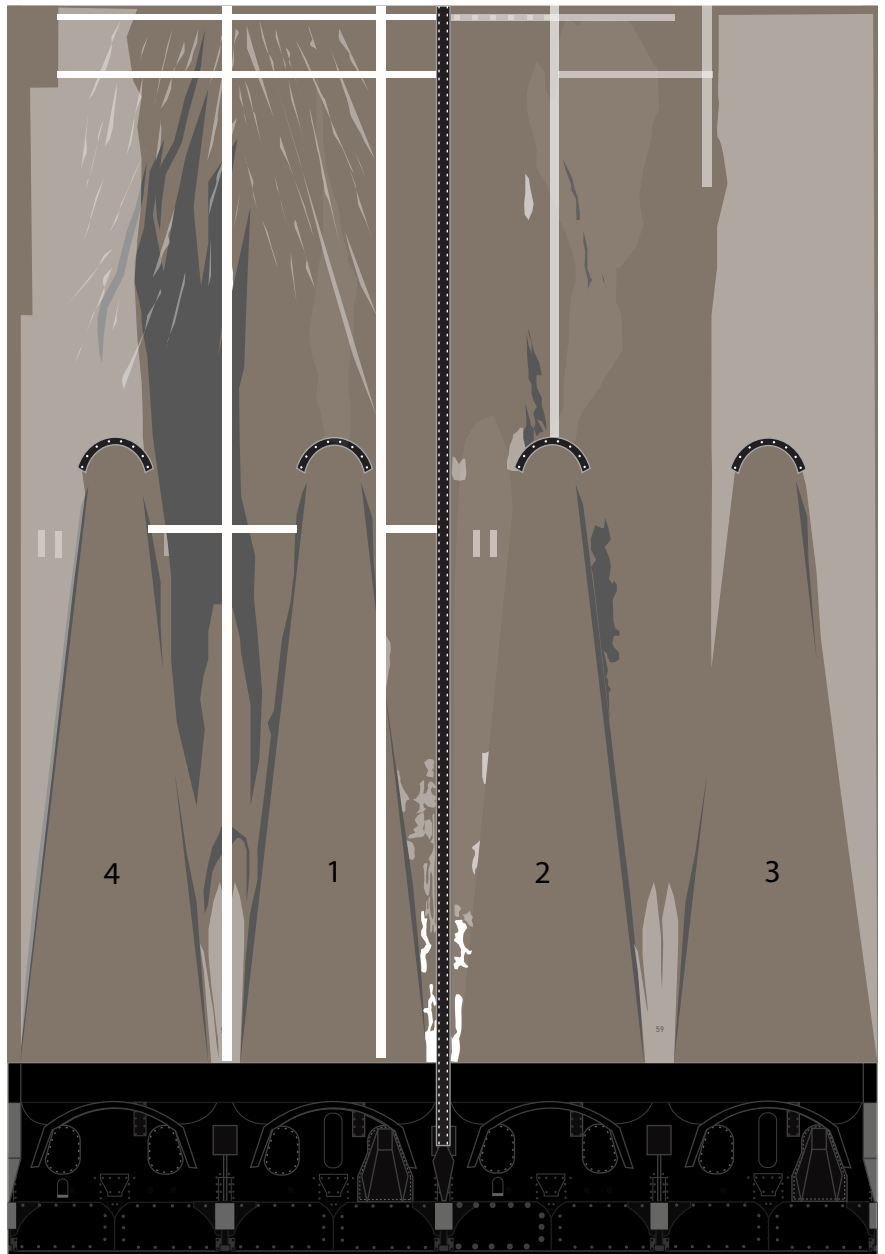
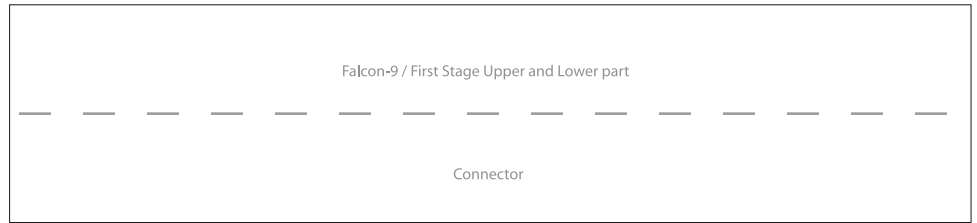



1:100 Scale



SPACE-X "Falcon 9 Block 5"

Print on Cardstock (110 lbs)

BLOCK 5

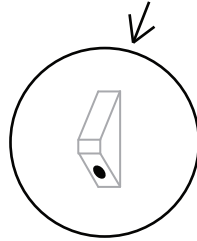
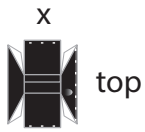

Thicker Raceway



bottom

Fairing Connector 2.0

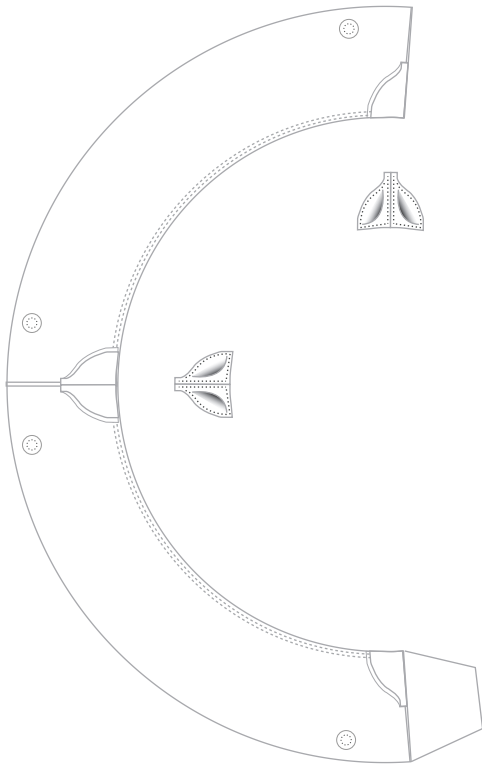



SPACE-X "Falcon-9 Block 5"

Print on Cardstock (110 lbs)



LEGS 2.0

1:100 Scale

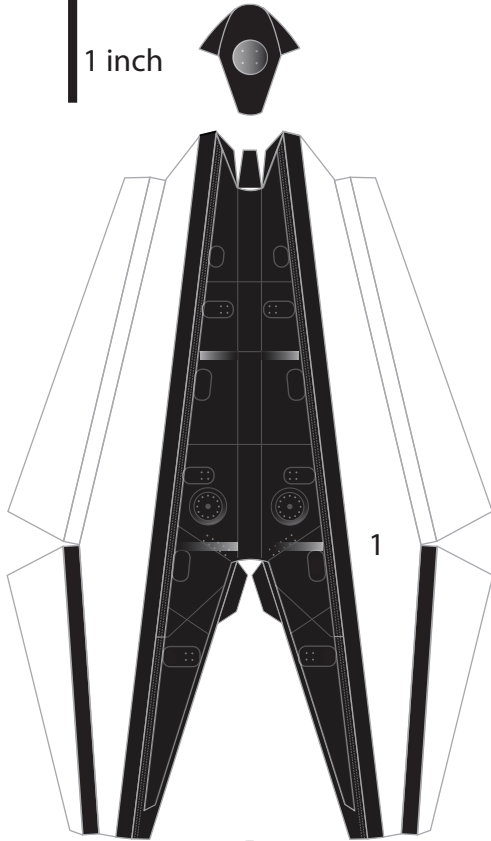
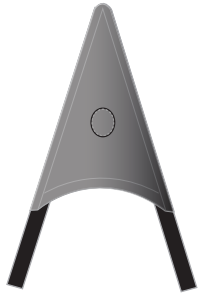

1

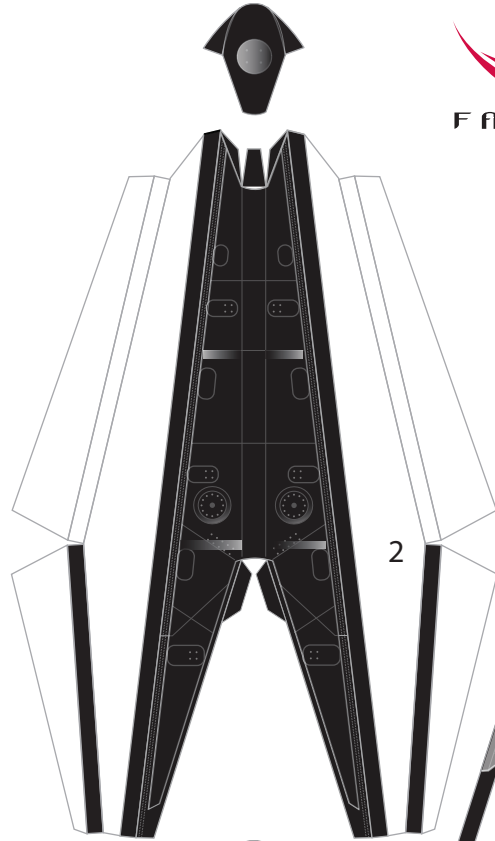

2

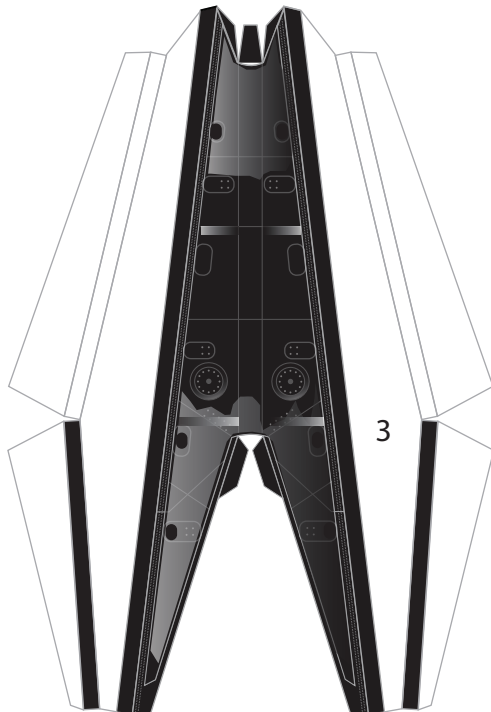
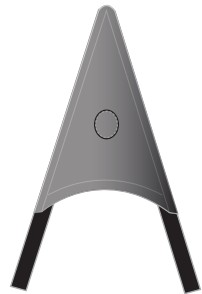
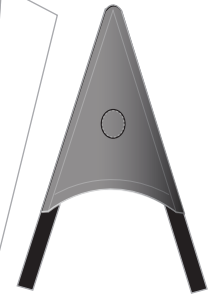

3

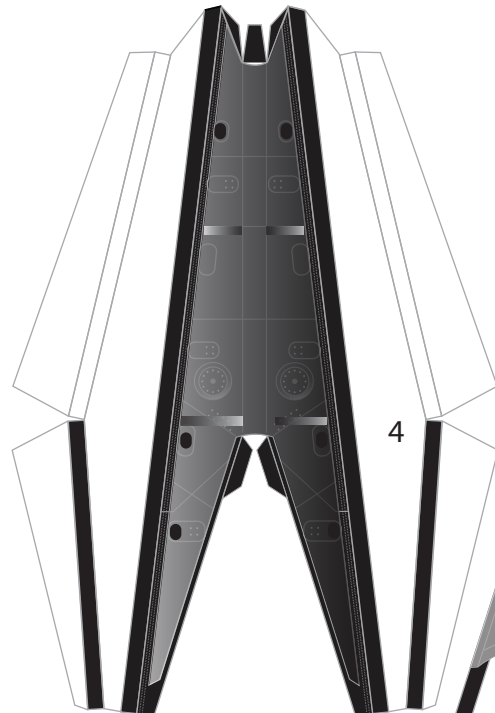

4

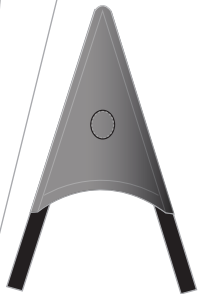



SPACE-X "Falcon 9 Block 5"

Print on Cardstock (110 lbs)



LEGS 2.0 page 2

Rev. 2



1:100 Scale

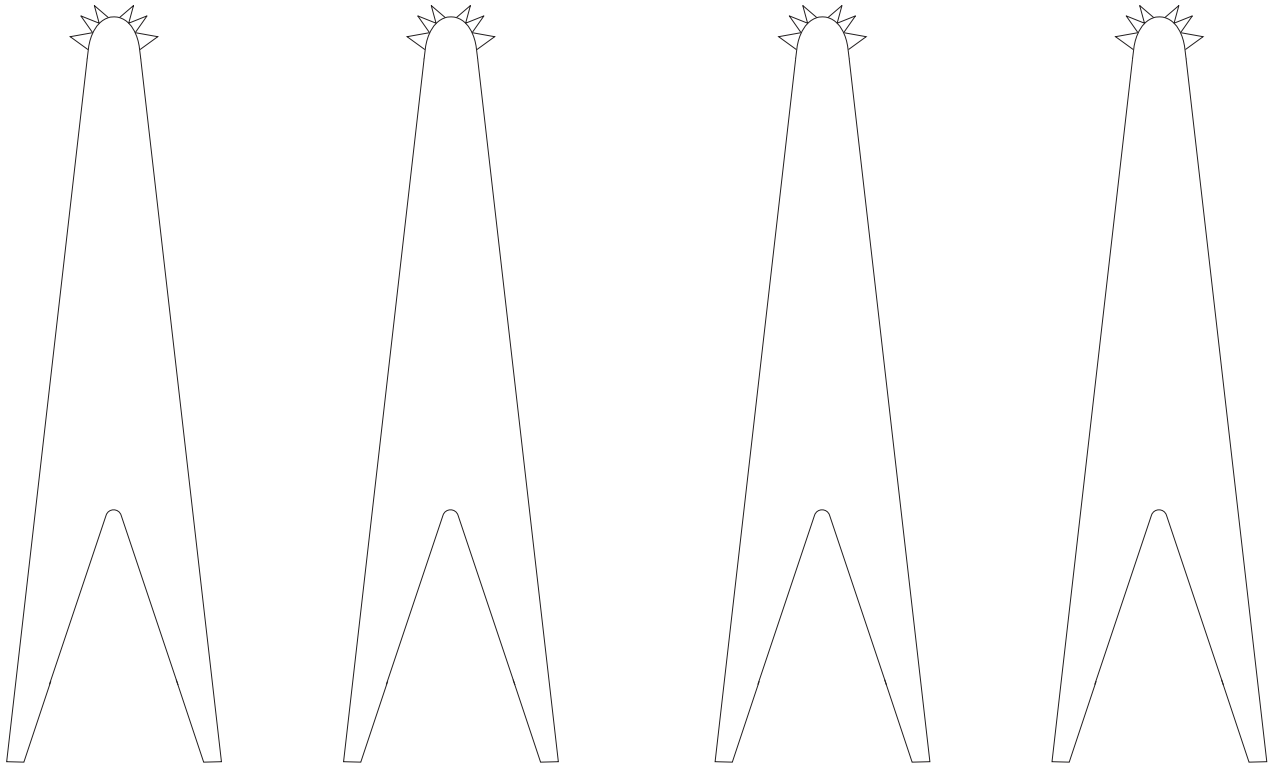

Legs pins

(roll the complete strip and then cut the individual pieces)

New Leg Hinges

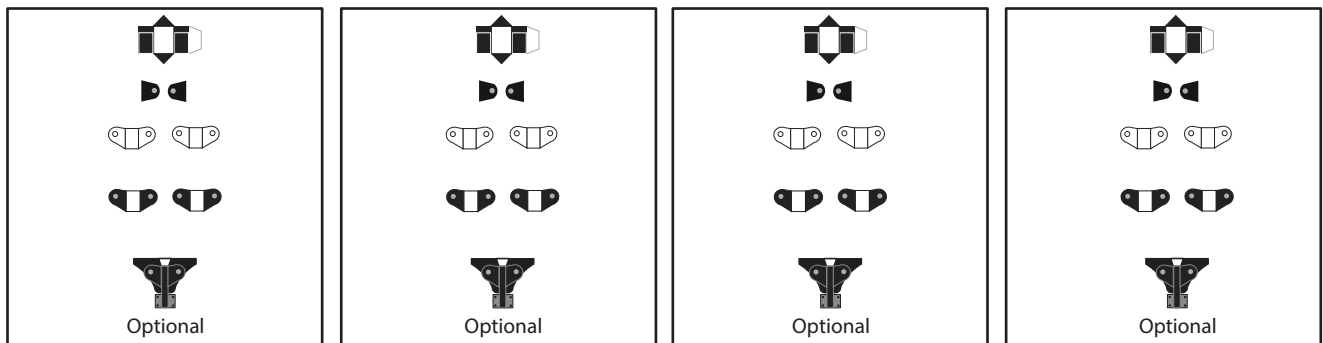



SPACE-X Falcon 9 Octaweb

Print on Cardstock (110 lbs)

MERLIN Engines

1:100 Scale

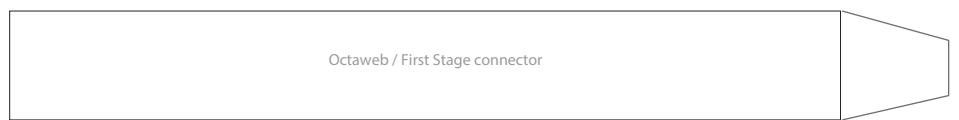
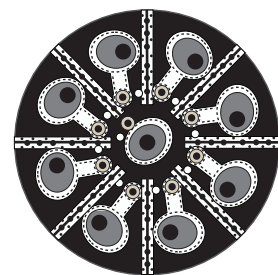
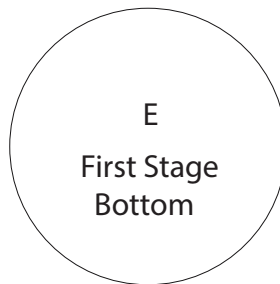
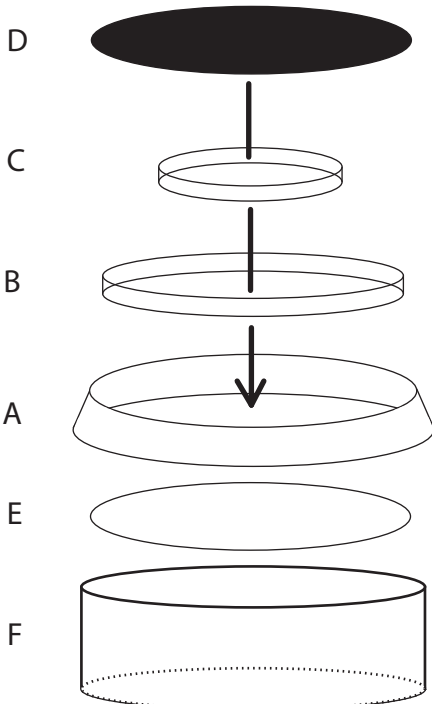
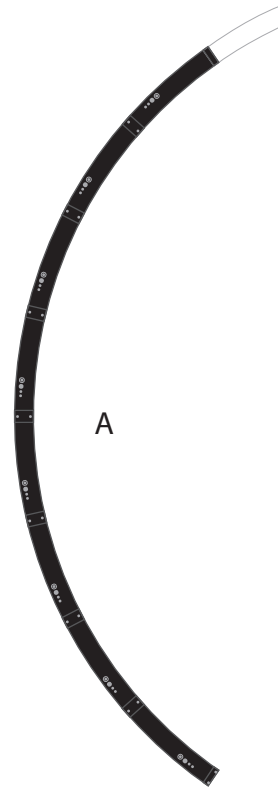
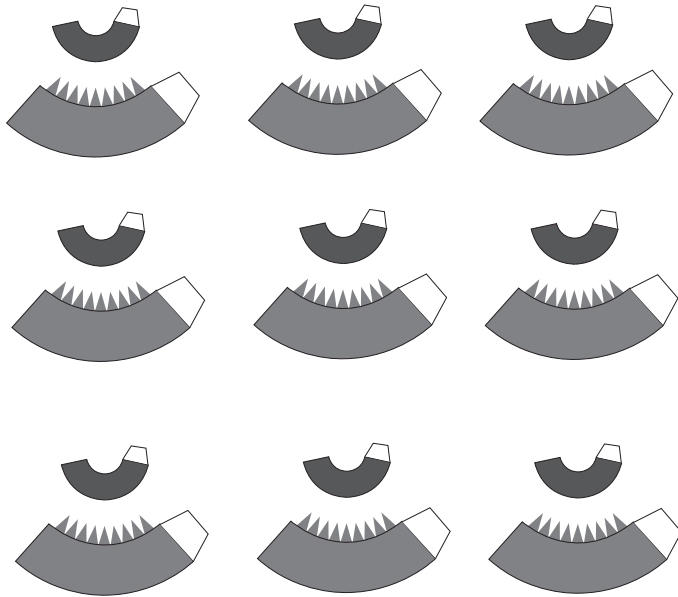



1:100 Scale



SPACE-X "Falcon 9" Octaweb

Print on Cardstock (110 lbs)

MERLIN Engines

BACK PRINT

