

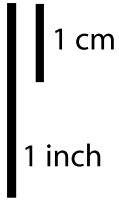

1:100 Scale



# SPACE-X "Falcon 9 Fairing 1.0"

Print on Cardstock (110 lbs)

Fairing 1.0 Revision

## RADARSAT

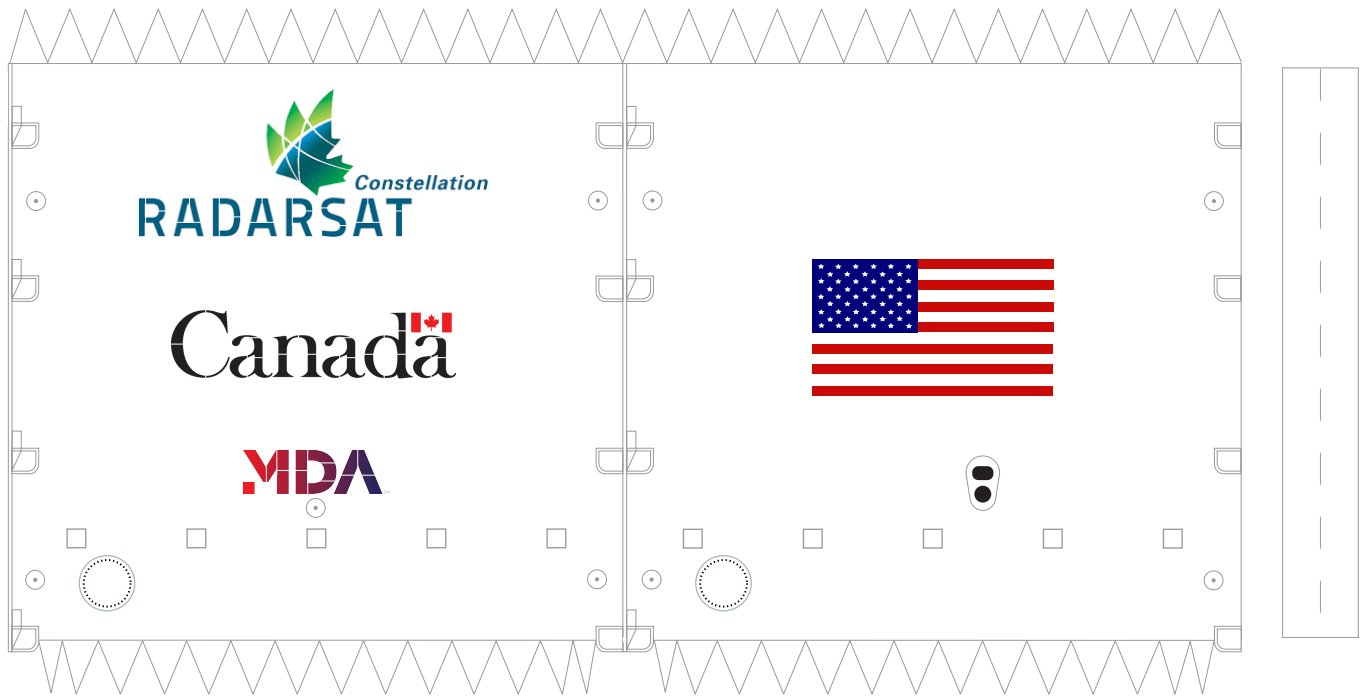
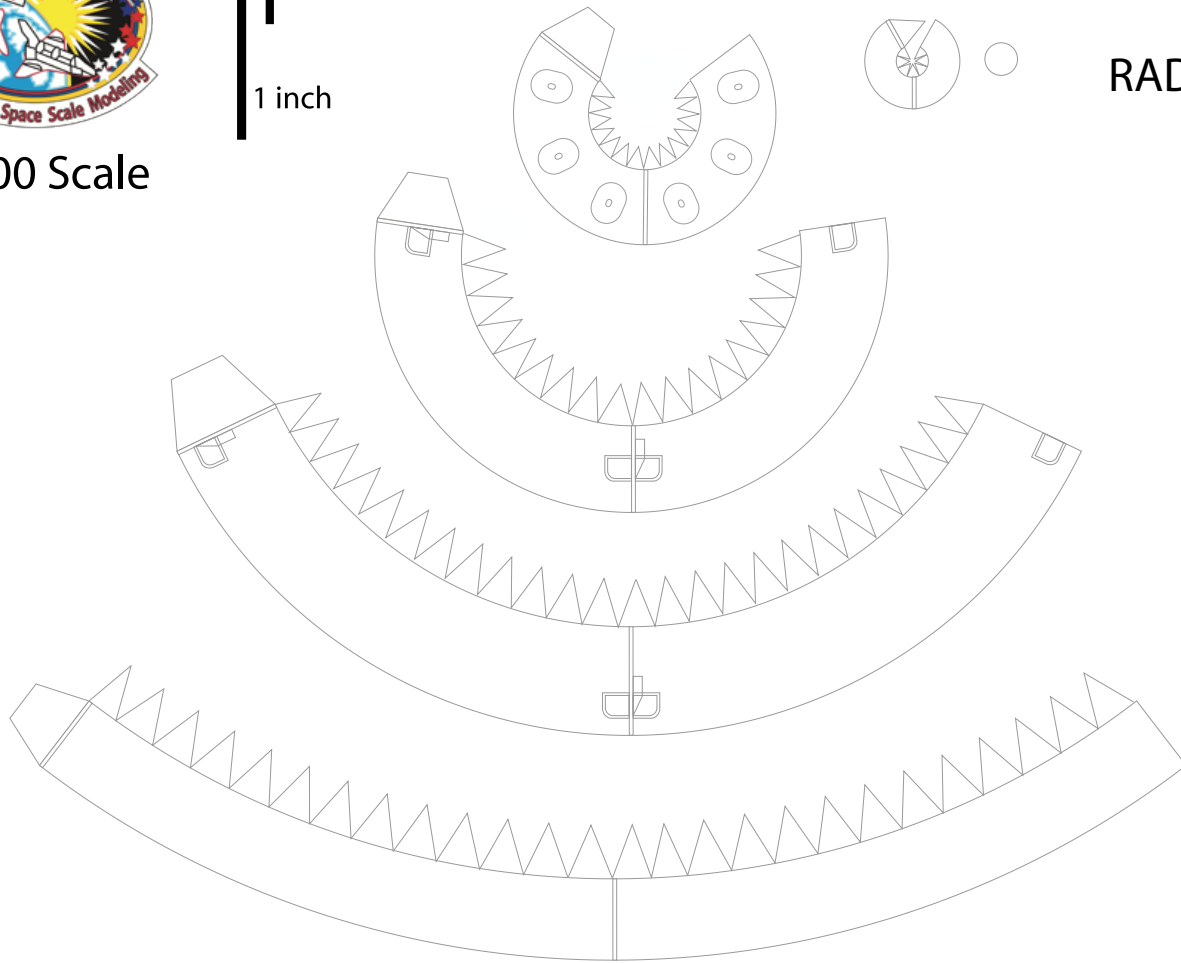



# SPACE-X "Falcon 9 Block 5"

Print on Cardstock (110 lbs)

Rev. 2

Enlarged Second Stage / Interstage

Block 5 Second Stage

Use for fairing 1.0

Titanium Grid Fins



1:100 Scale



# FALCON 9

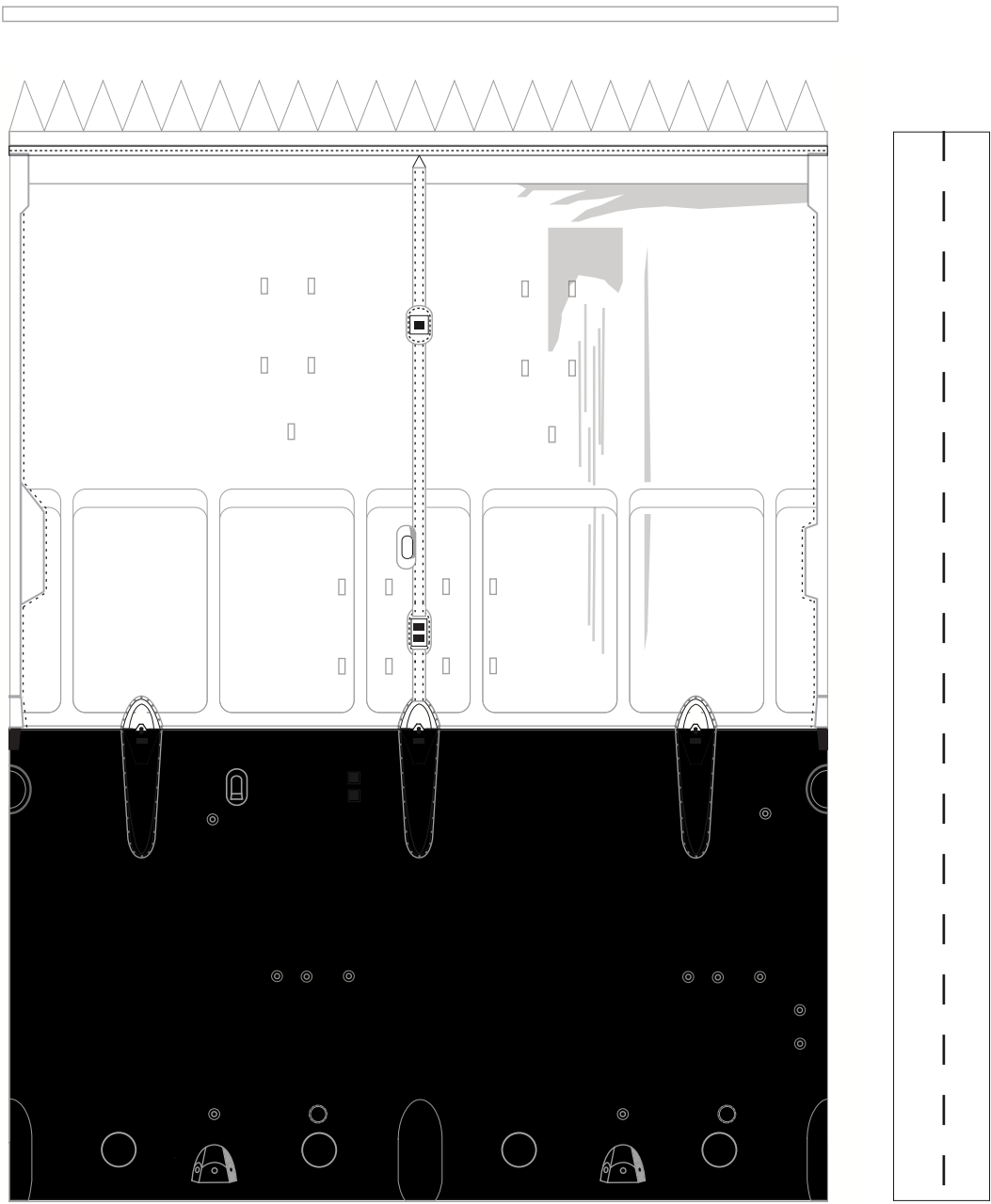
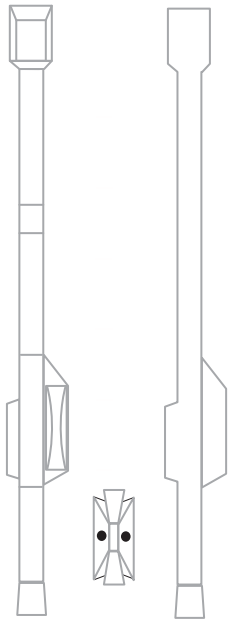

Titanium Grid Fins

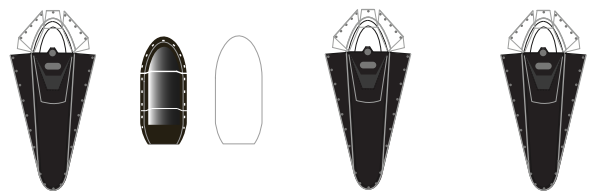
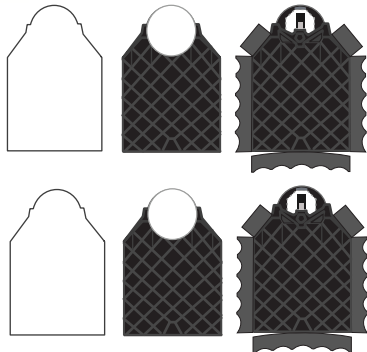
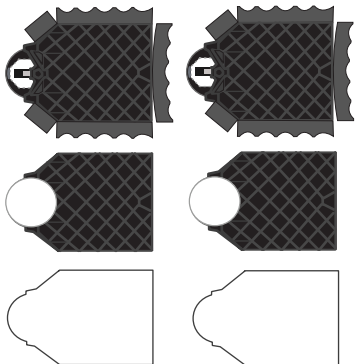



1:100 Scale

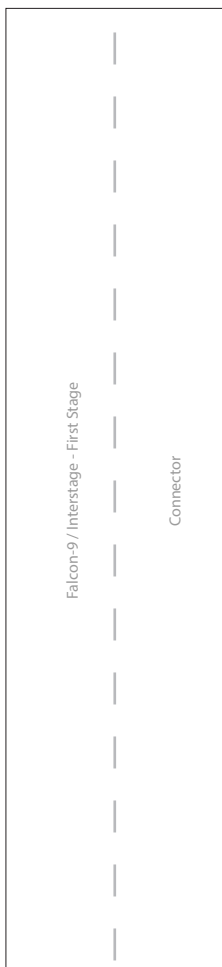

# SPACE-X "Falcon 9 Block 5"

Print on Cardstock (110 lbs)  
RADARSAT

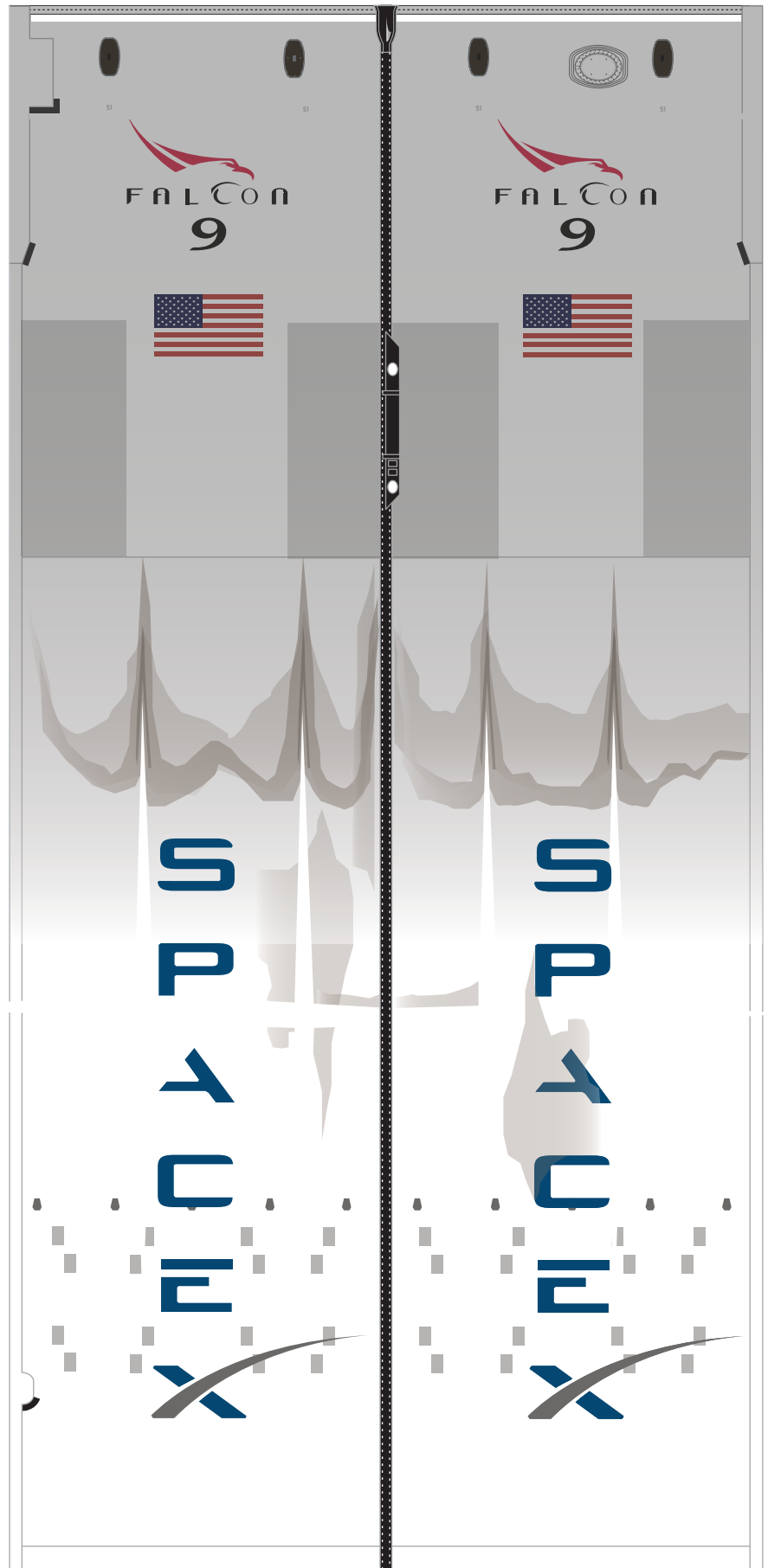



1:100 Scale



FALCON  
9

# SPACE-X "Falcon 9 Block 5"

Print on Cardstock (110 lbs)

Rev. 1  
Block 5

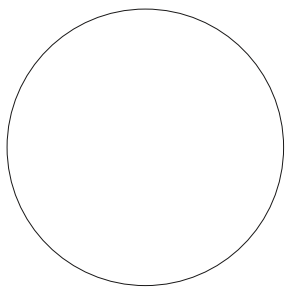
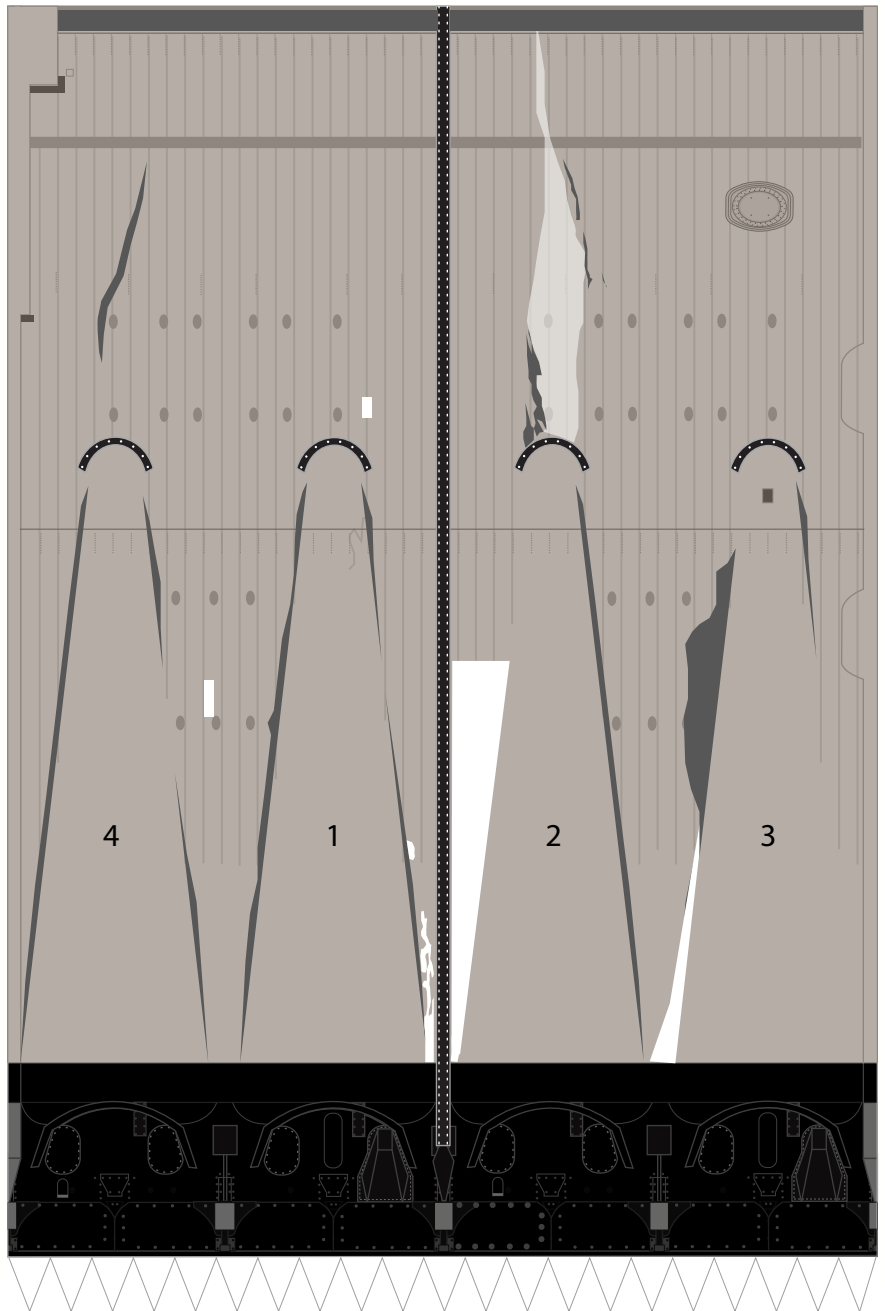
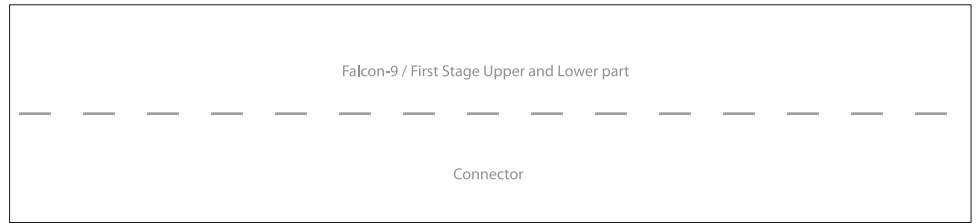



1:100 Scale



# SPACE-X "Falcon 9 Block 5"

Print on Cardstock (110 lbs)

BLOCK 5

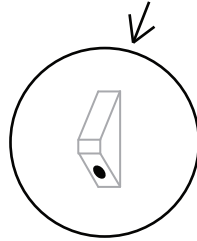

Thicker Raceway



bottom

Fairing Connector 1.0

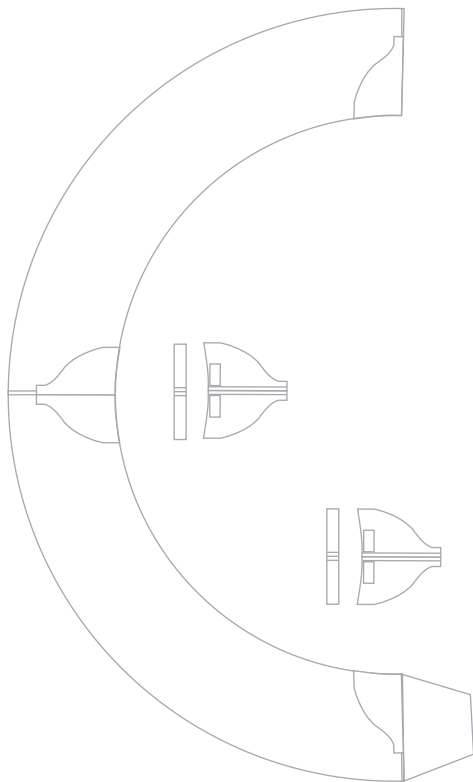



1:100 Scale

# SPACE-X "Falcon-9 Block 5"

Print on Cardstock (110 lbs)

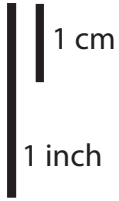

## LEGS 2.0

Starlink

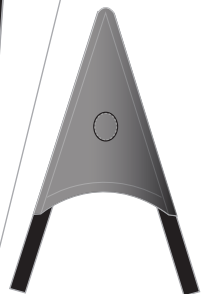
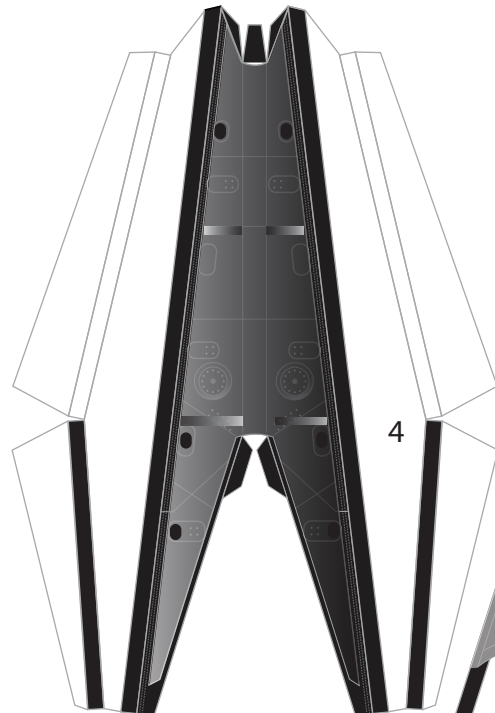
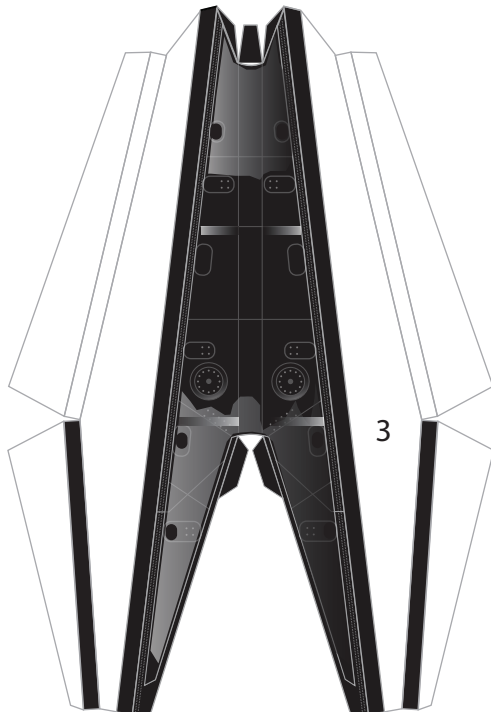
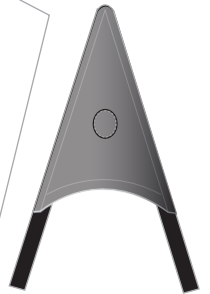
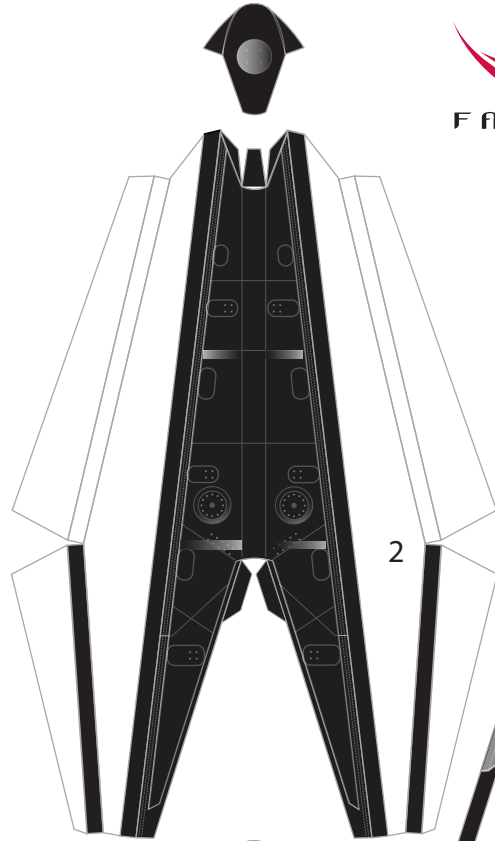
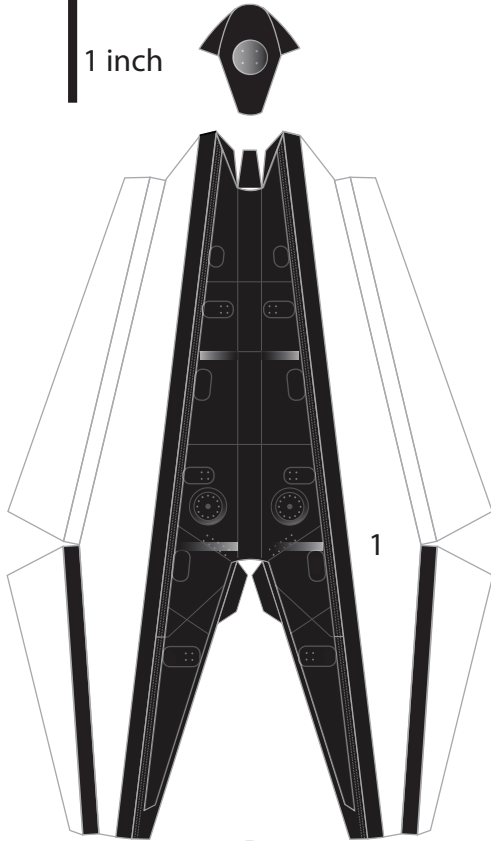
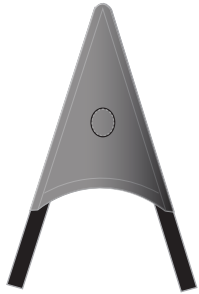



# SPACE-X "Falcon 9 Block 5"

Print on Cardstock (110 lbs)



LEGS 2.0 page 2

Rev. 2



1:100 Scale

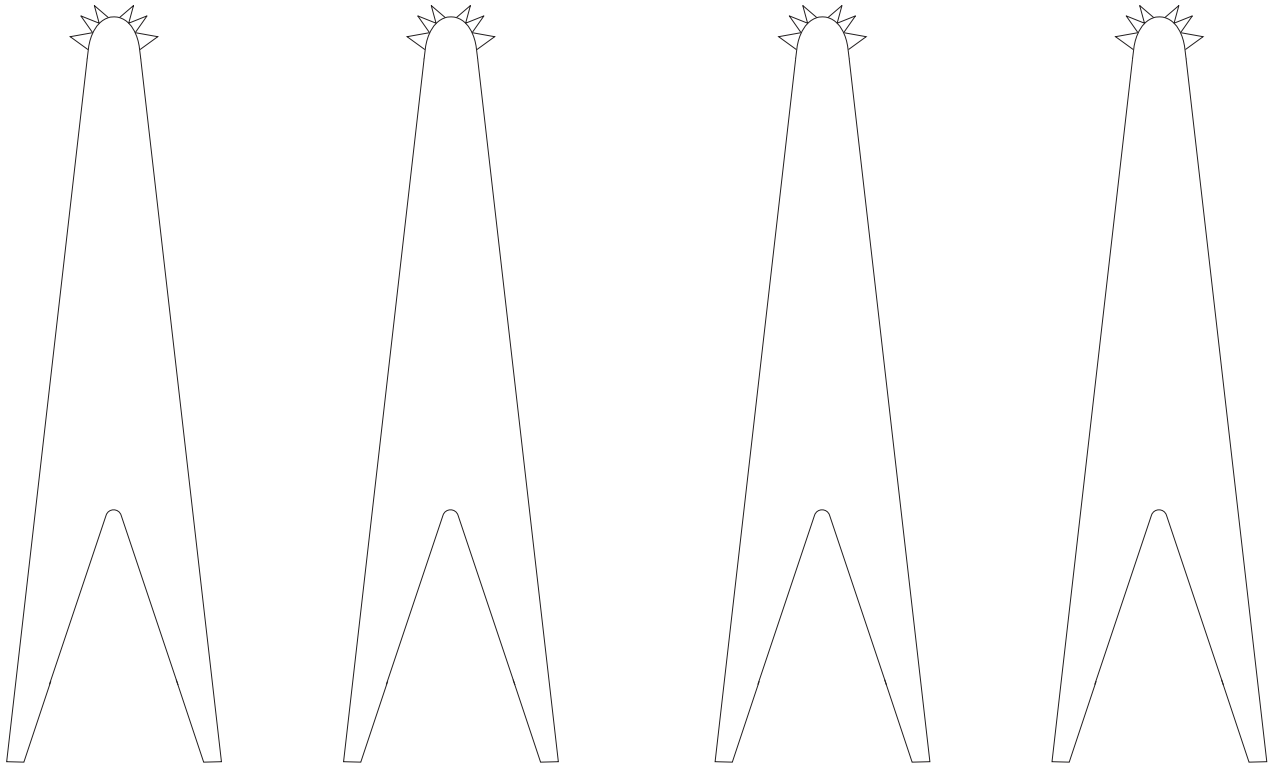

Legs pins

(roll the complete strip and then cut the individual pieces)

## New Leg Hinges

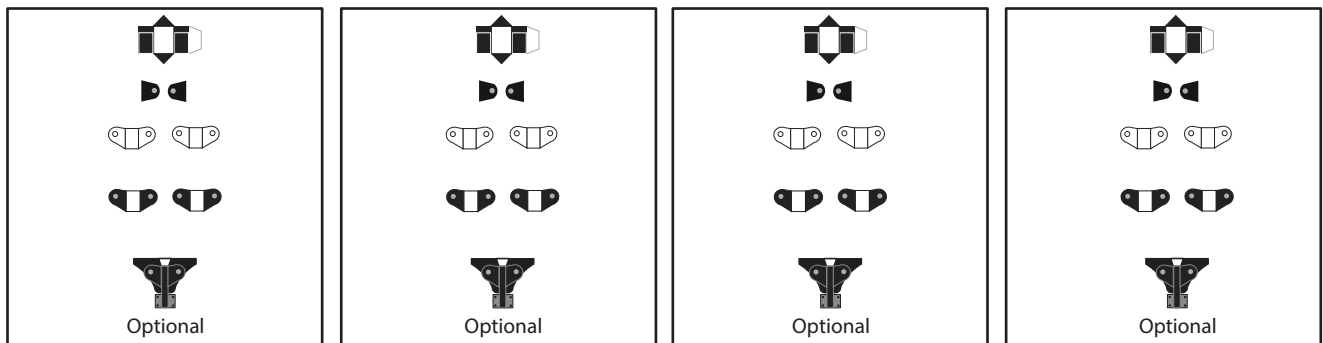



1:100 Scale



# SPACE-X "Falcon 9 Block 5"

## MERLIN Engines

Print on Cardstock (110 lbs)

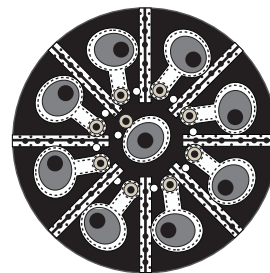
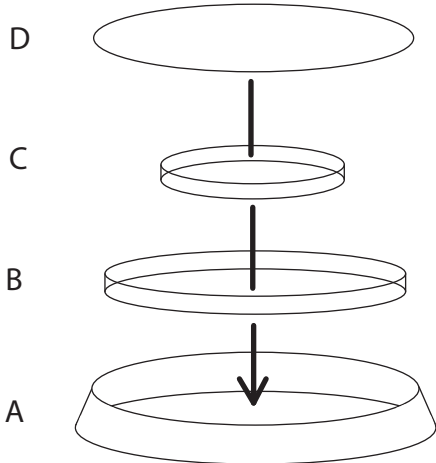
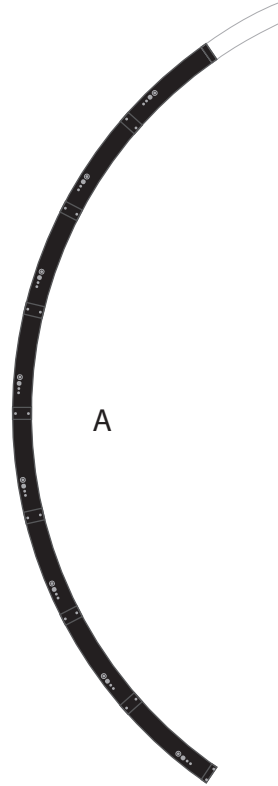
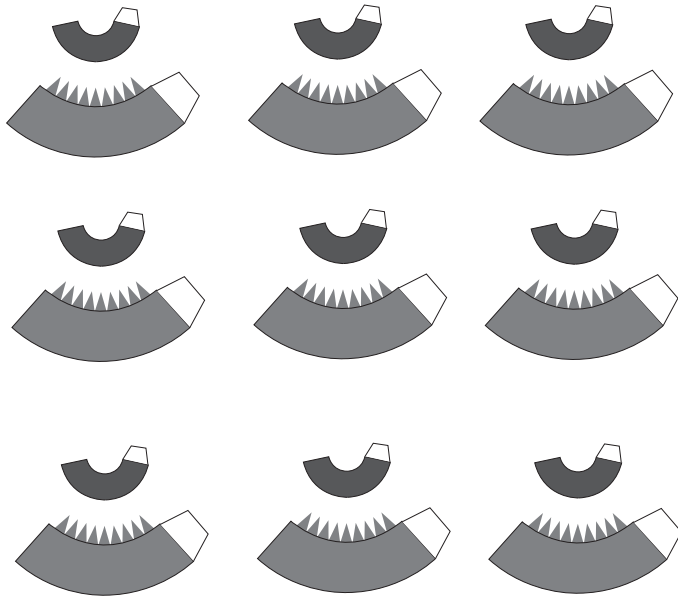

Engine Grid  
OCTAWEB





1:100 Scale



SPACE-X "Falcon 9 Block 5"

Print on Cardstock (110 lbs)

MERLIN Engines

BACK PRINT

