

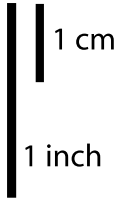

# SPACE-X "Falcon 9 Fairing 2.0"

Print on Cardstock (110 lbs)



1:100 Scale

# SSO-A

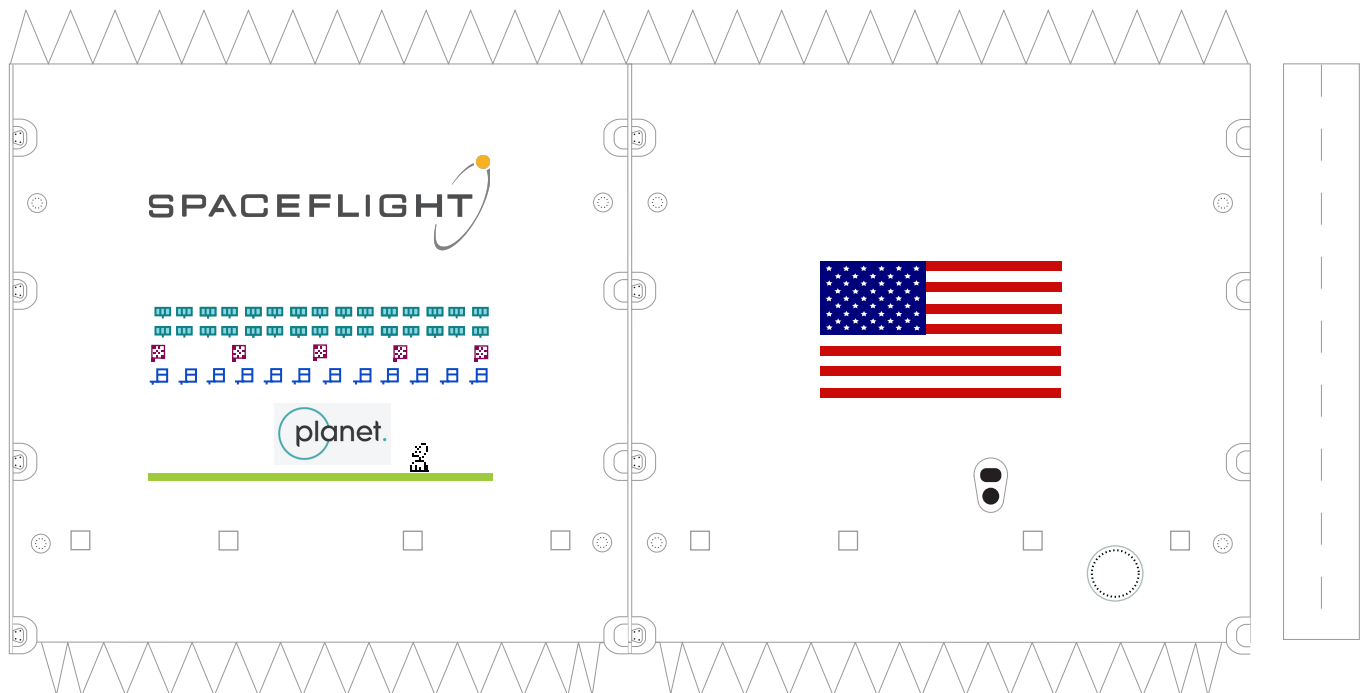
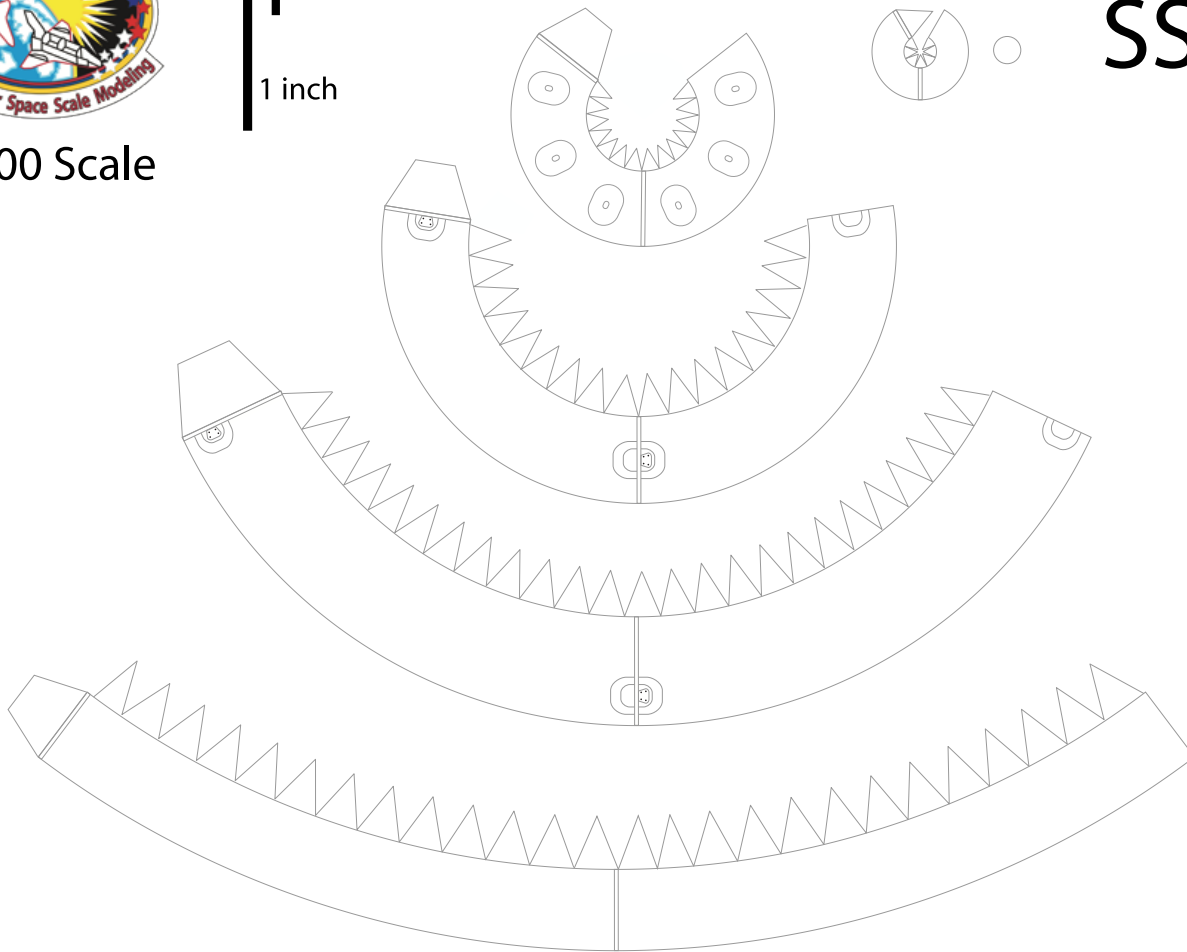



# SPACE-X "Falcon 9 Block 5"

Print on Cardstock (110 lbs)

Rev. 2

Enlarged Second Stage / Interstage  
Use for Fairing 2.0

Block 5 Second Stage  
Titanium Grid Fins

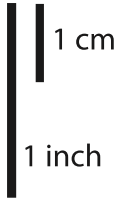

1:100 Scale

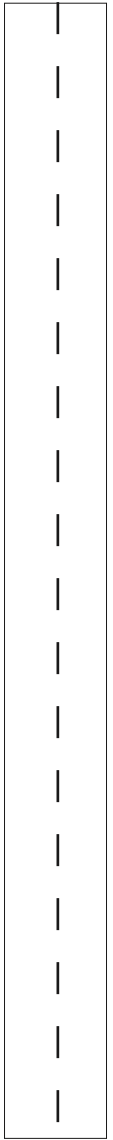
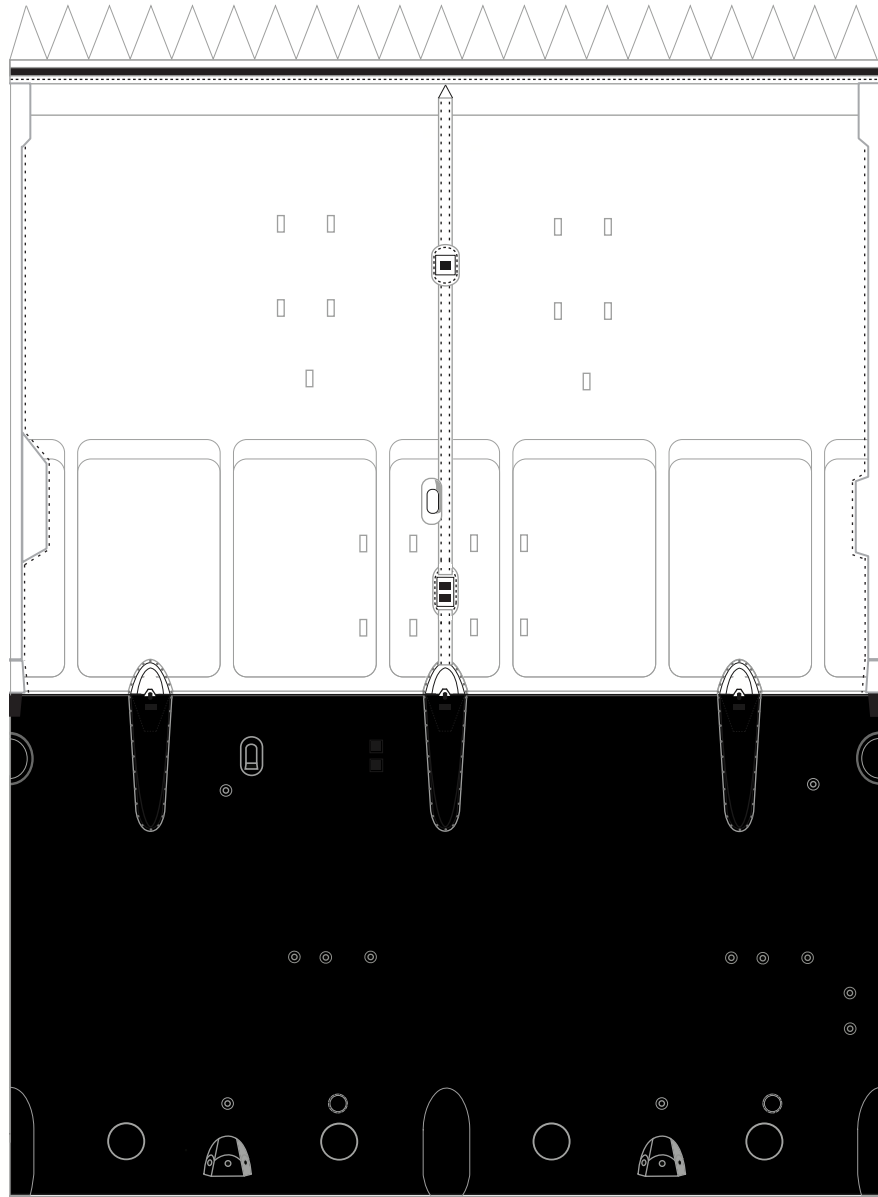
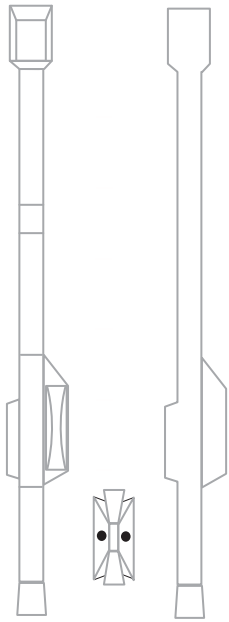

Titanium Grid Fins

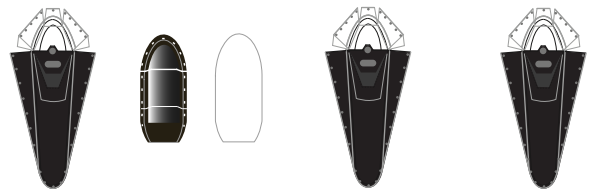
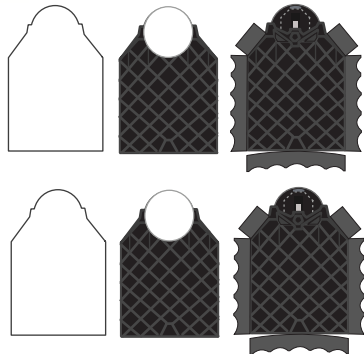
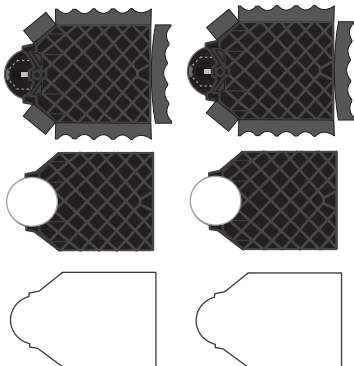



1:100 Scale

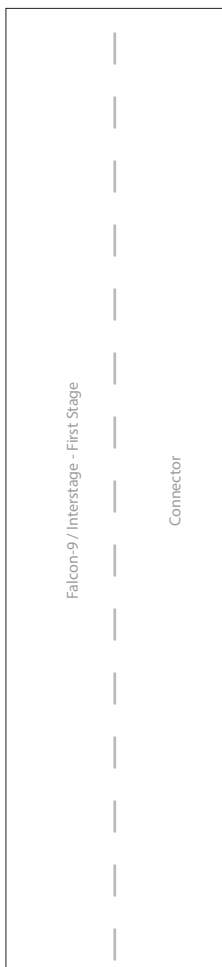

# SPACE-X "Falcon 9 Block 5"

Print on Cardstock (110 lbs)  
SSO-A

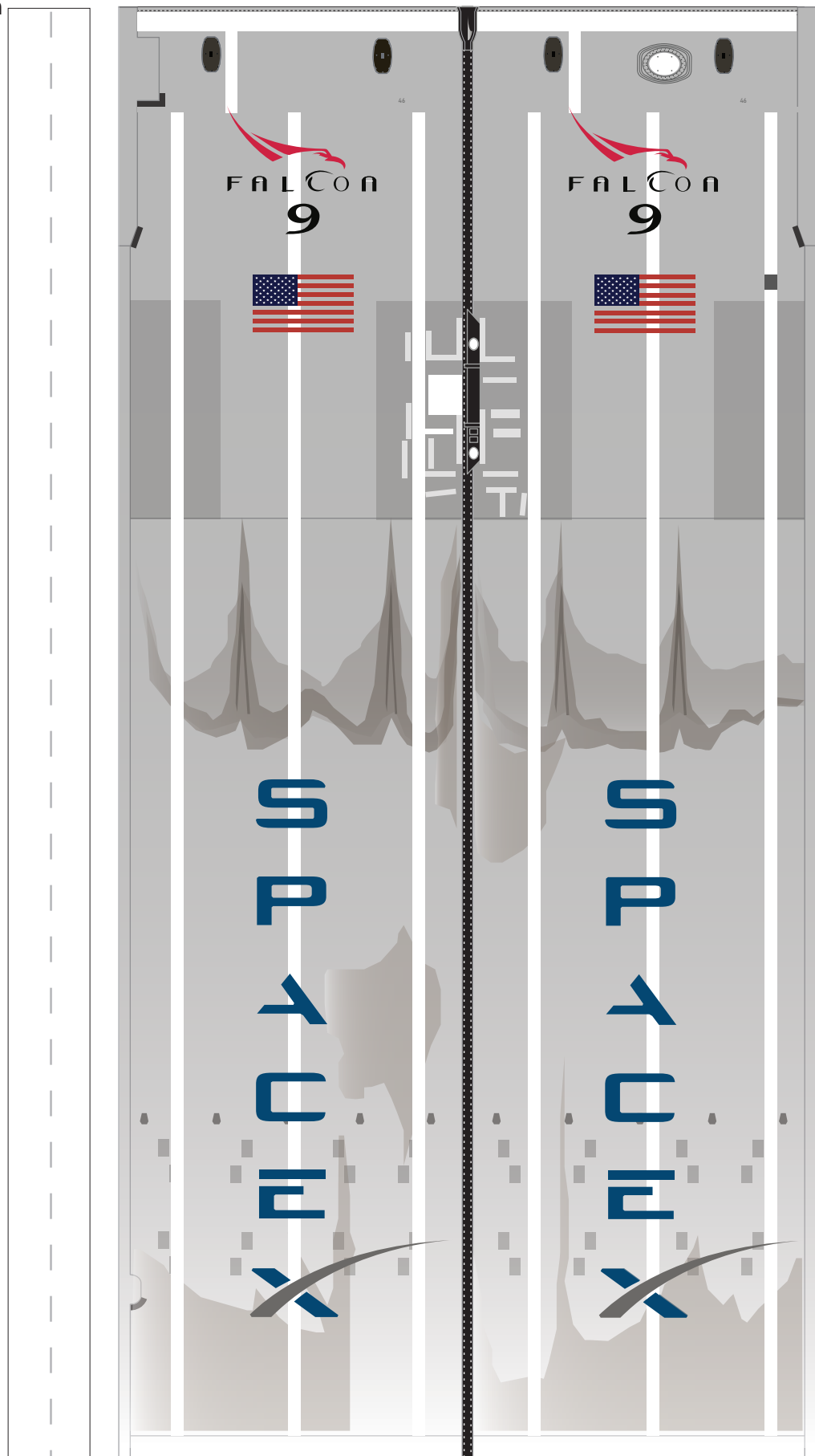



1:100 Scale



FALCON  
9

# SPACE-X "Falcon 9 Block 5"

Print on Cardstock (110 lbs)

SSO-A

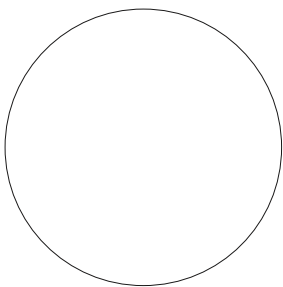
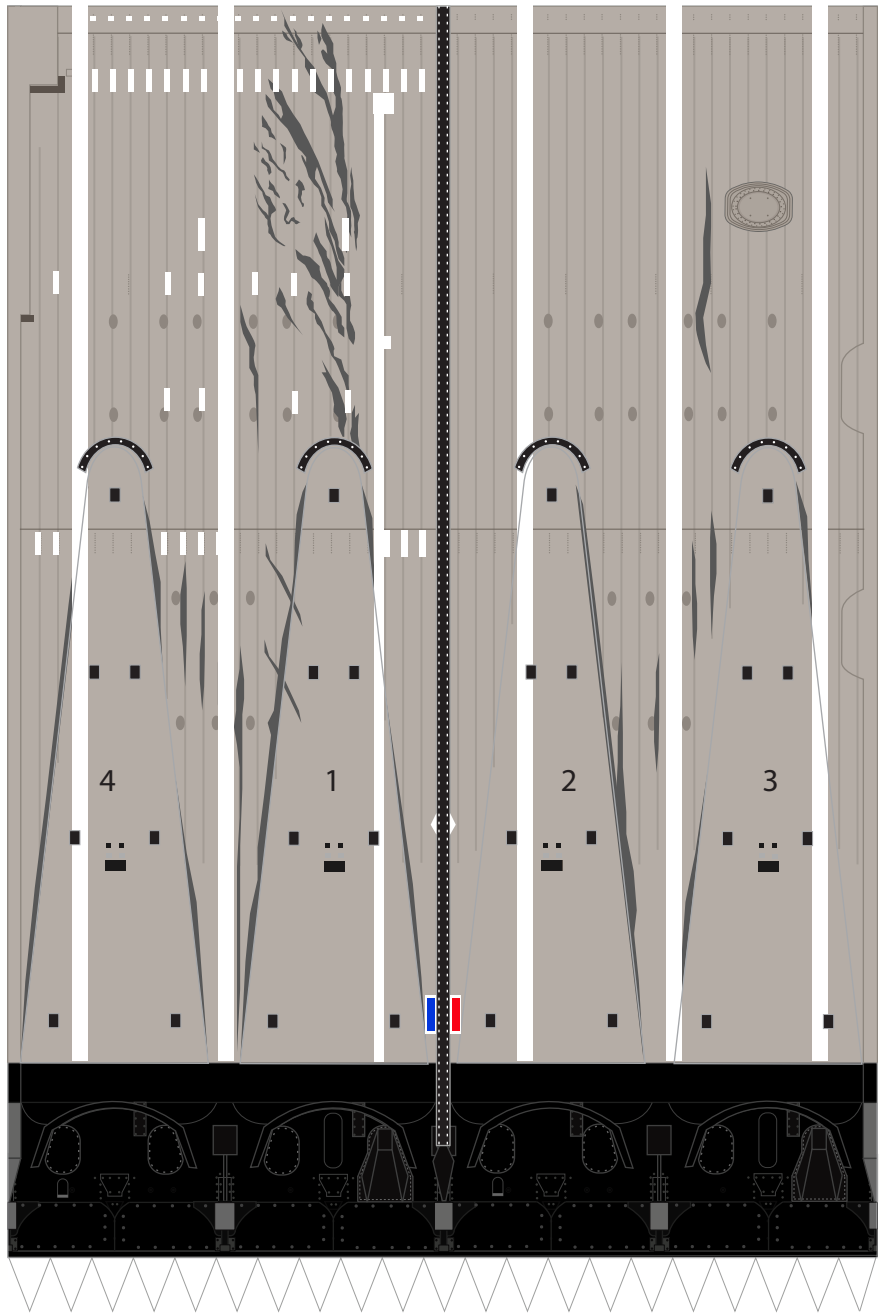
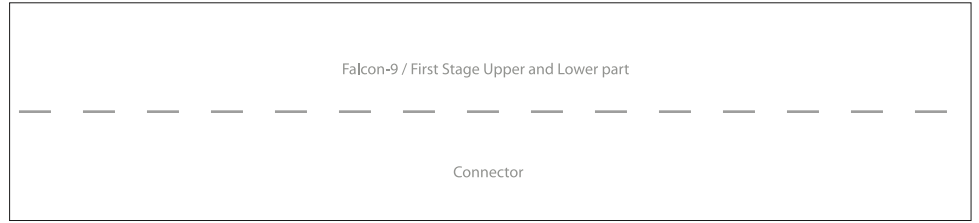



1:100 Scale



# SPACE-X "Falcon 9 Block 5"

Print on Cardstock (110 lbs)

BLOCK 5

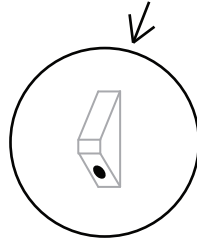

Thicker Raceway



bottom

Fairing Connector 2.0

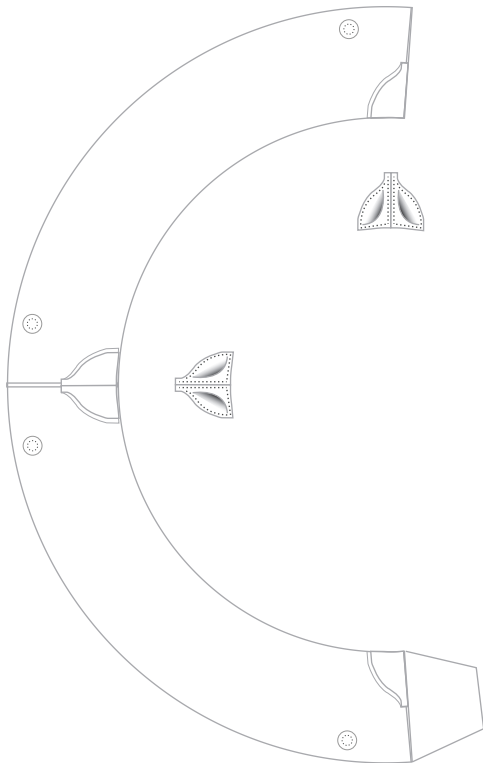



1:100 Scale



# SPACE-X "Falcon 9 Block 5"

Print on Cardstock (110 lbs)

## MERLIN Engines

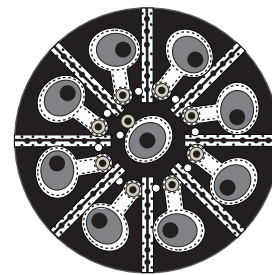
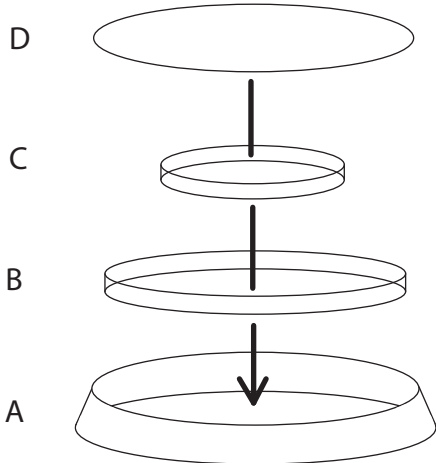
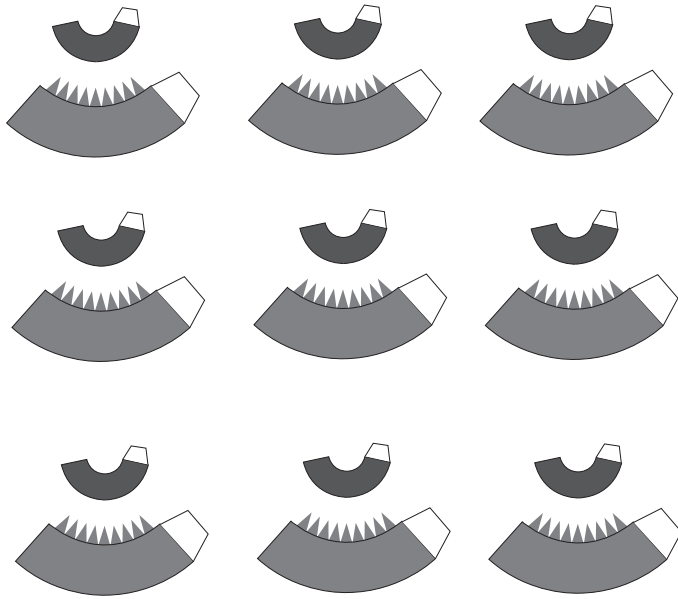

Engine Grid  
OCTAWEB



1:100 Scale

# SPACE-X "Falcon-9 Block 5"

Print on Cardstock (110 lbs)

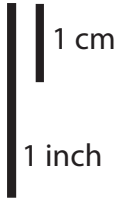

## LEGS 2.0

SSO-A

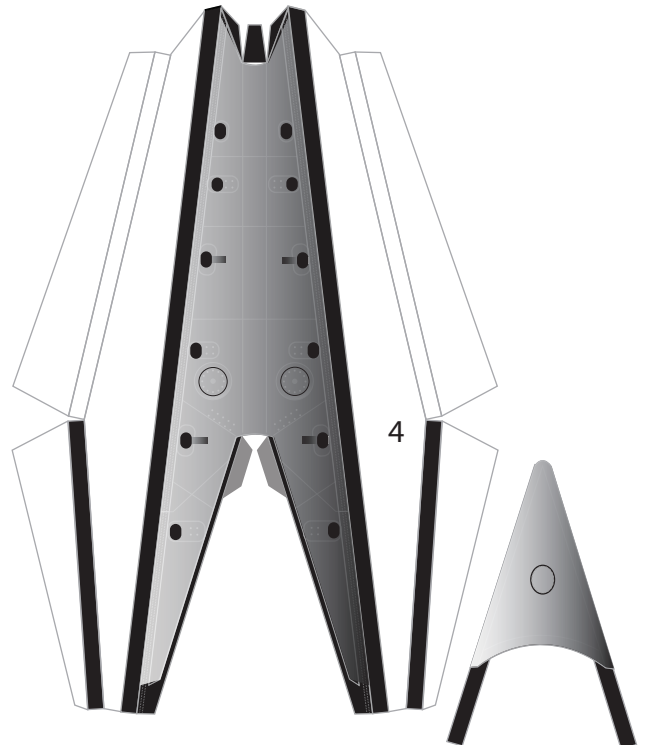
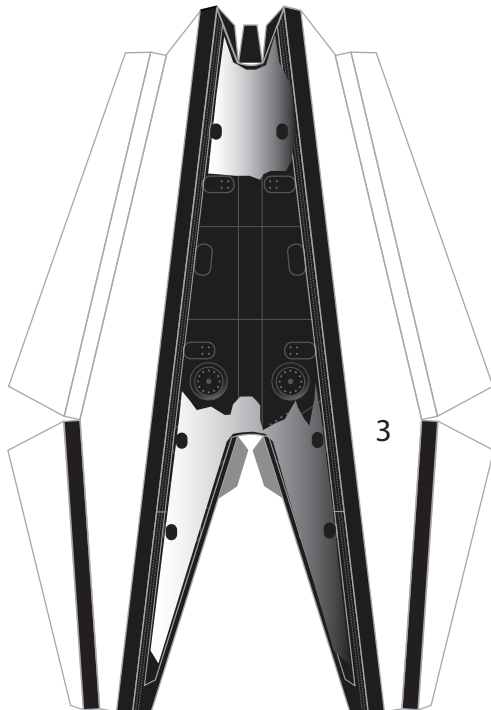
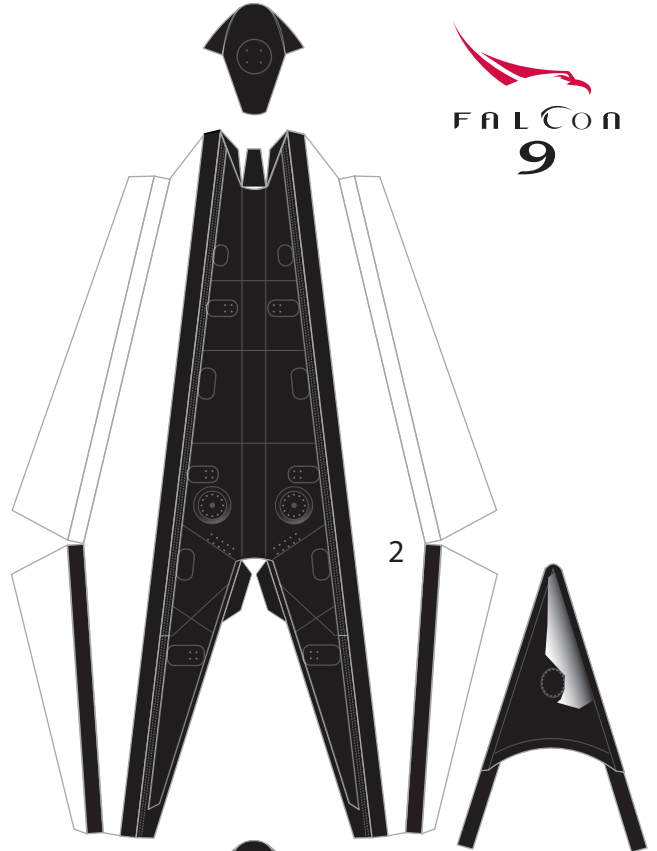
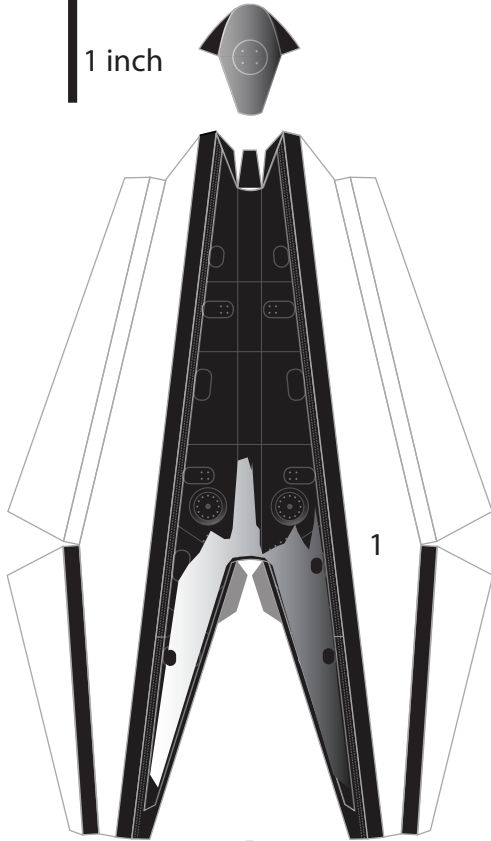



# SPACE-X "Falcon 9 Block 5"

Print on Cardstock (110 lbs)

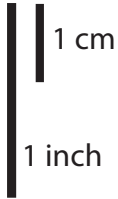

LEGS 2.0 page 2

Rev. 2



1:100 Scale

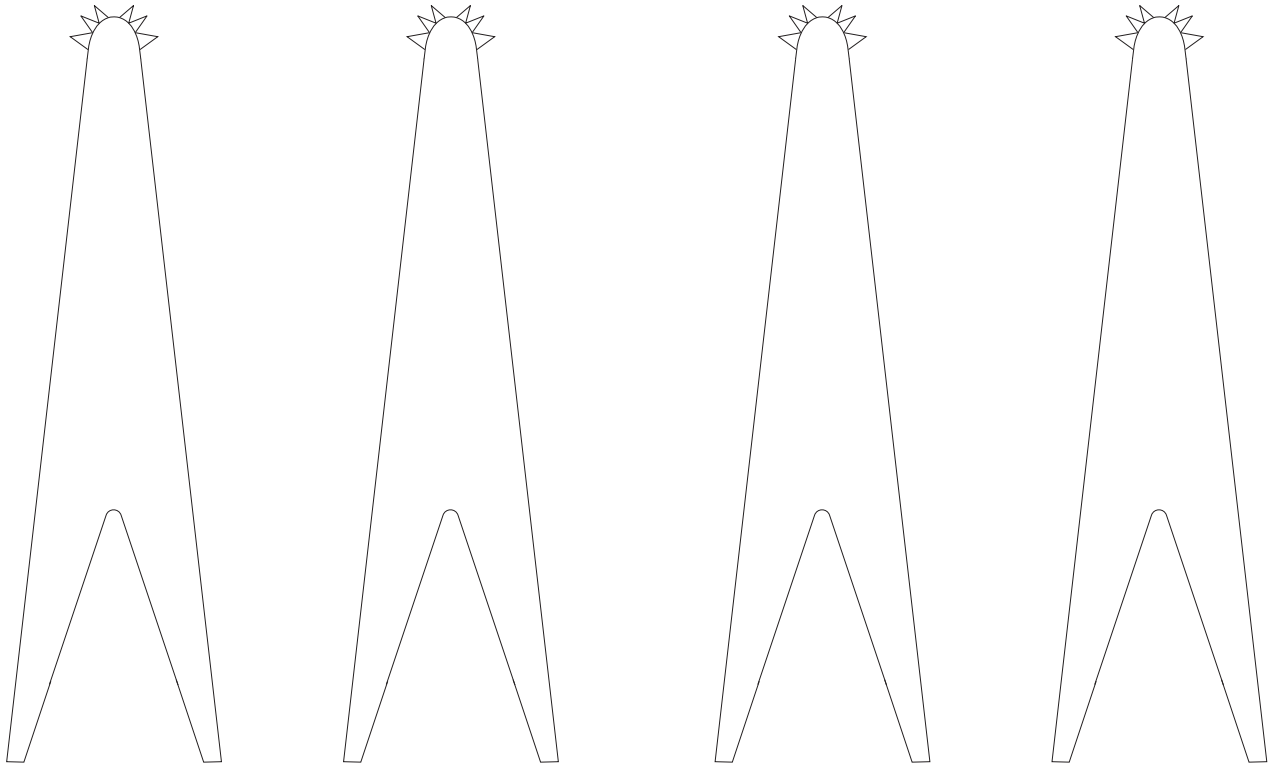

Legs pins

(roll the complete strip and then cut the individual pieces)

## New Leg Hinges

