

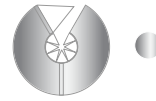

# SPACE-X "Falcon 9 Fairing 2.0"

Print on Cardstock (110 lbs)

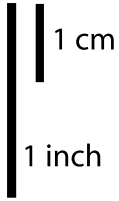

## STARLINK-10

### 1:100 Scale

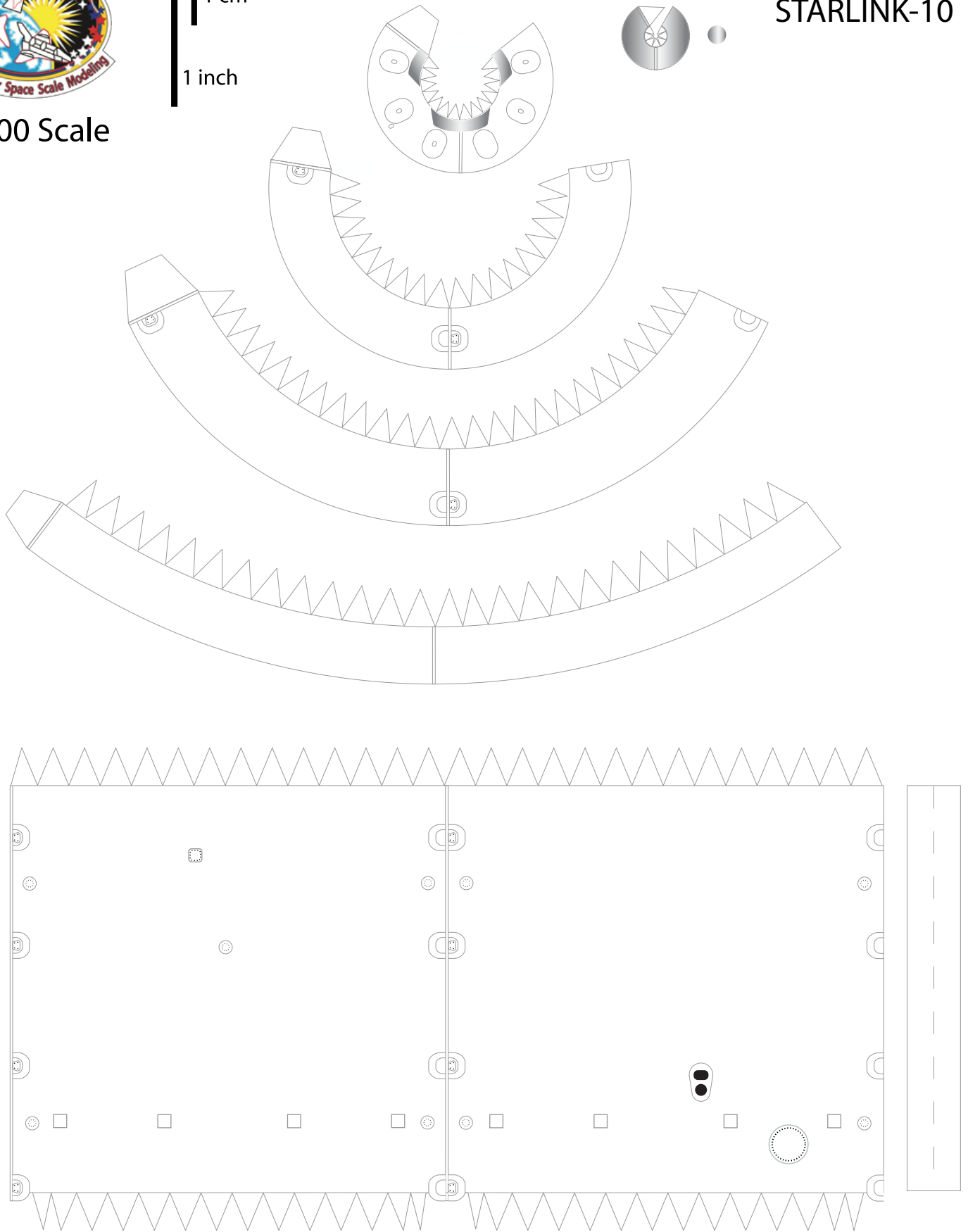



# SPACE-X "Falcon 9 Block 5"

Print on Cardstock (110 lbs)

Rev. 3

Enlarged Second Stage / Interstage  
Use for Fairing 2.0

Block 5 Second Stage  
Titanium Grid Fins



1:100 Scale

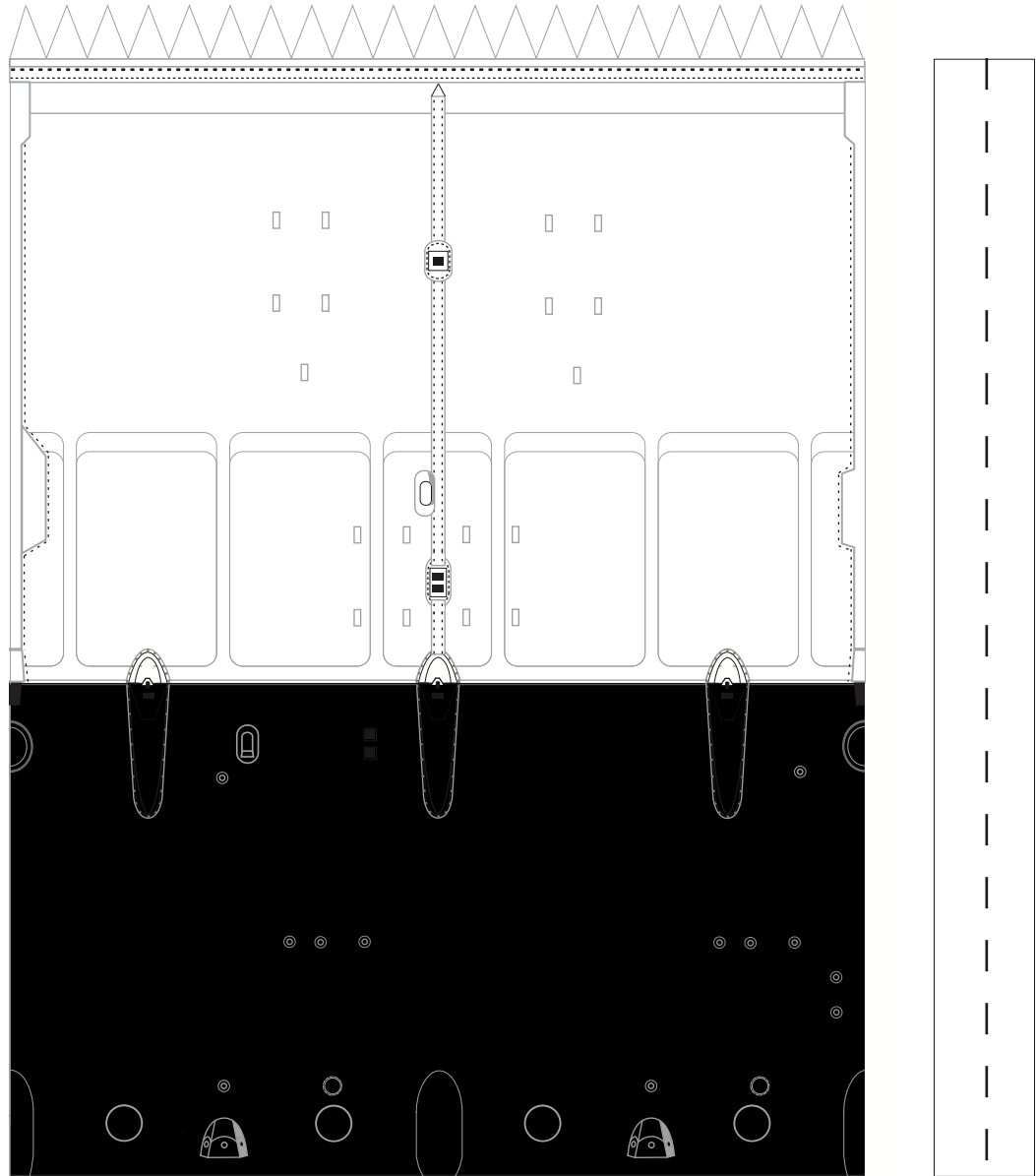
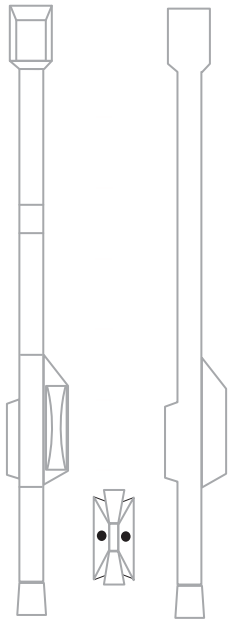

Titanium Grid Fins

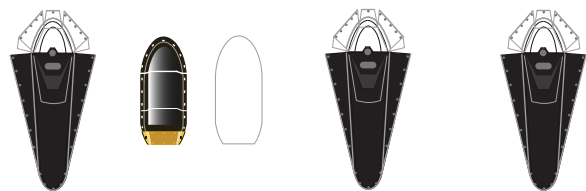
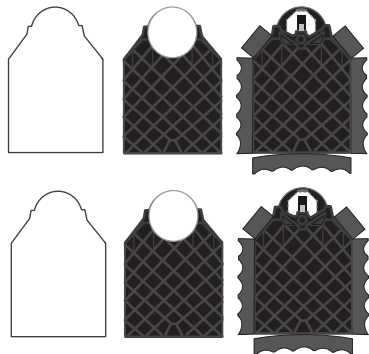
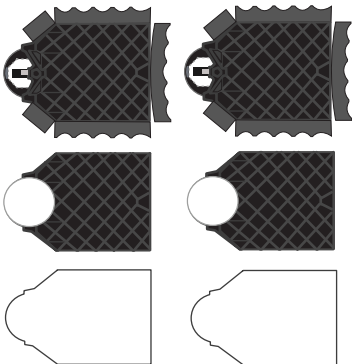



1:100 Scale

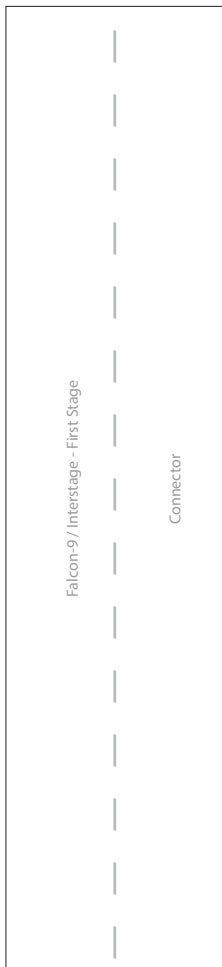

# SPACE-X "Falcon 9 Block 5" Starlink-15

Print on Cardstock (110 lbs)

Block 5

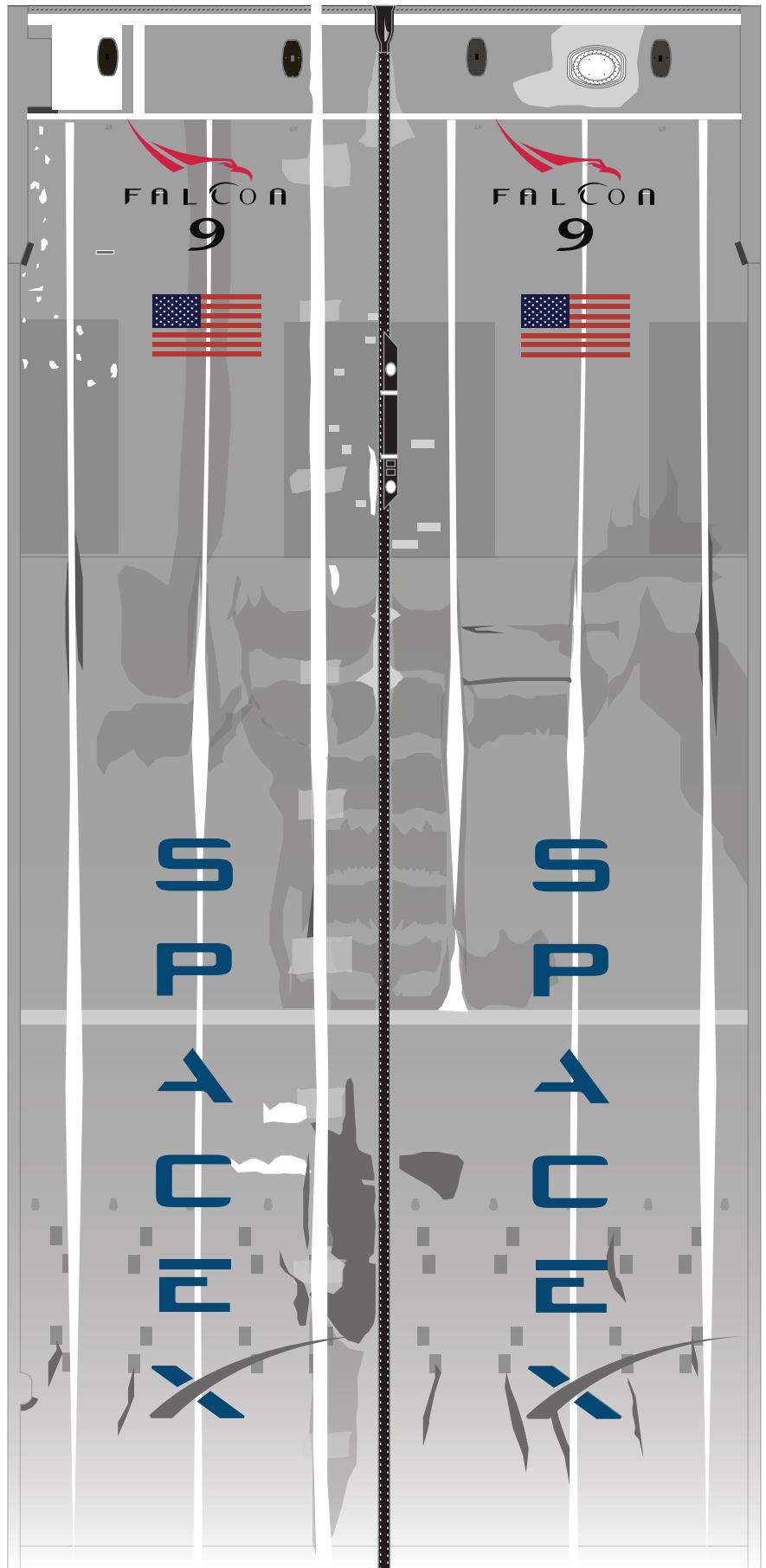
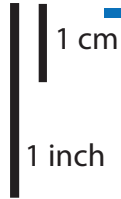



1:100 Scale



# SPACE-X "Falcon 9 Block 5"

Print on Cardstock (110 lbs)

Starlink-15

Block 5

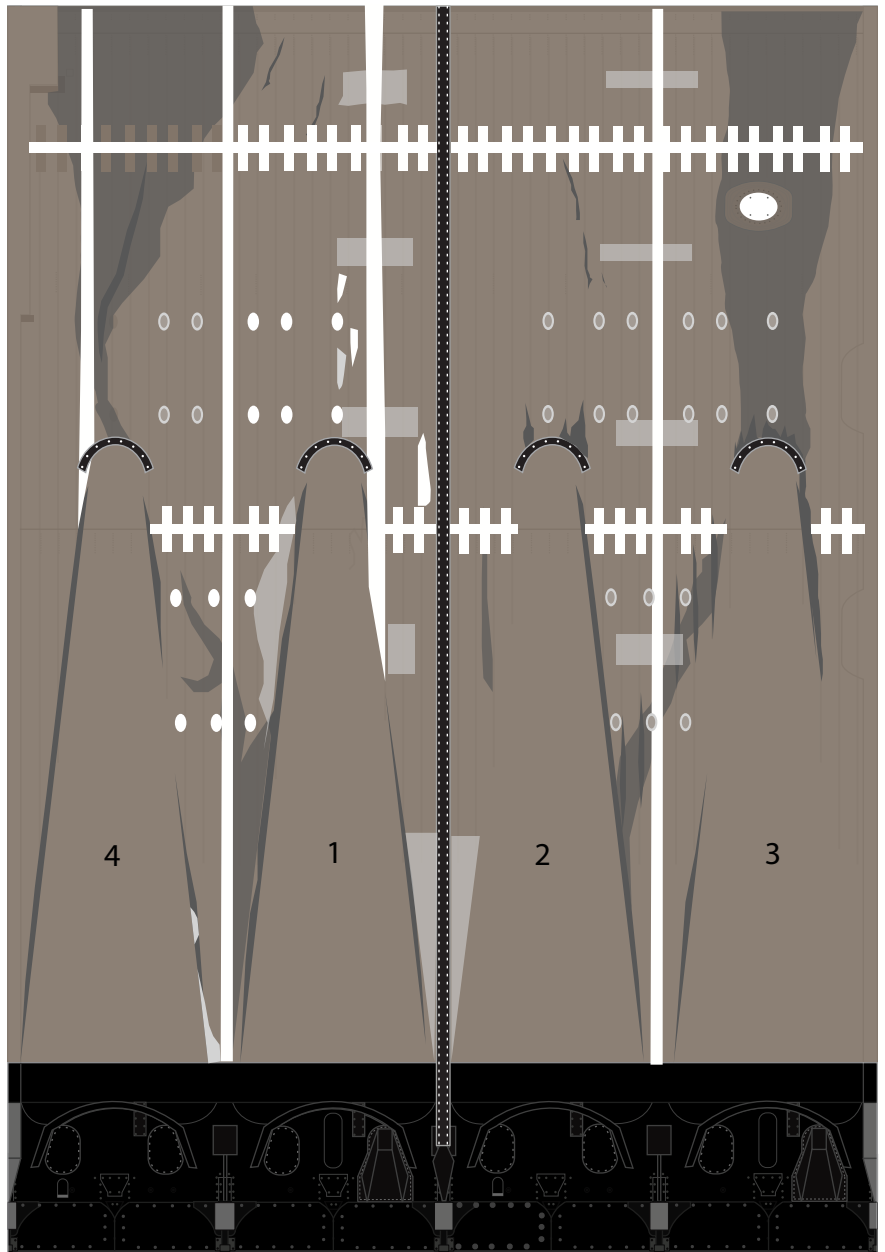
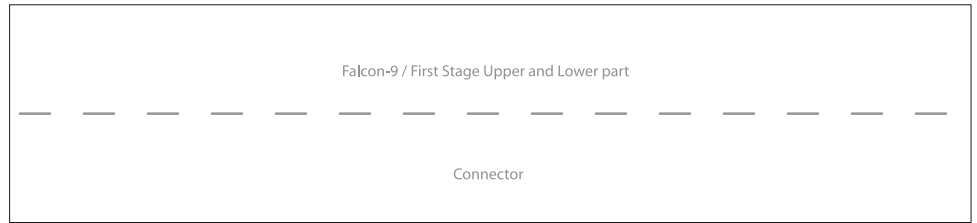
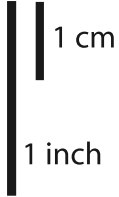



1:100 Scale



# SPACE-X "Falcon 9 Block 5"

Print on Cardstock (110 lbs)

BLOCK 5

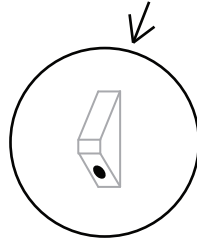

Thicker Raceway



bottom

Fairing Connector 2.0

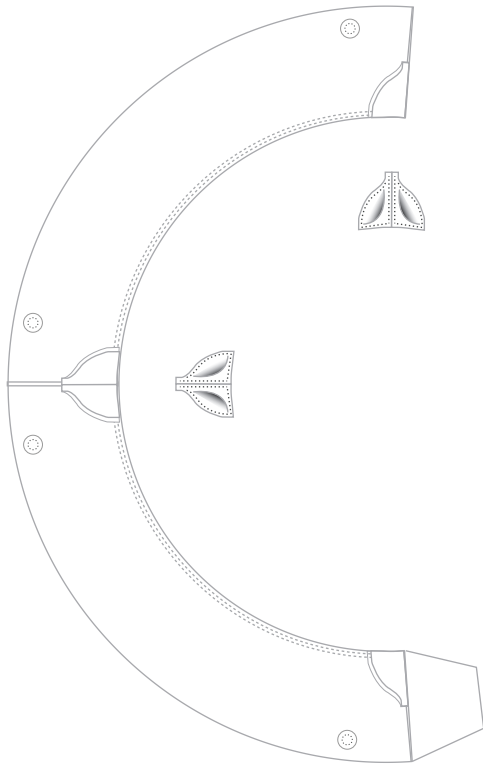



# SPACE-X "Falcon-9 Block 5"

Print on Cardstock (110 lbs)

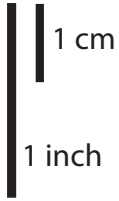

## LEGS 2.0

Starlink



1:100 Scale

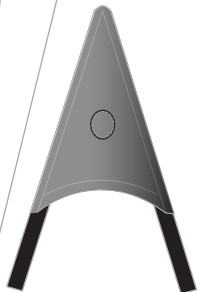
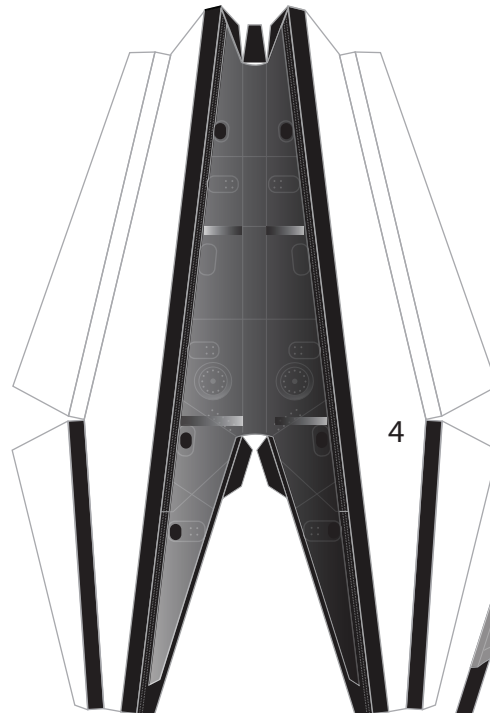
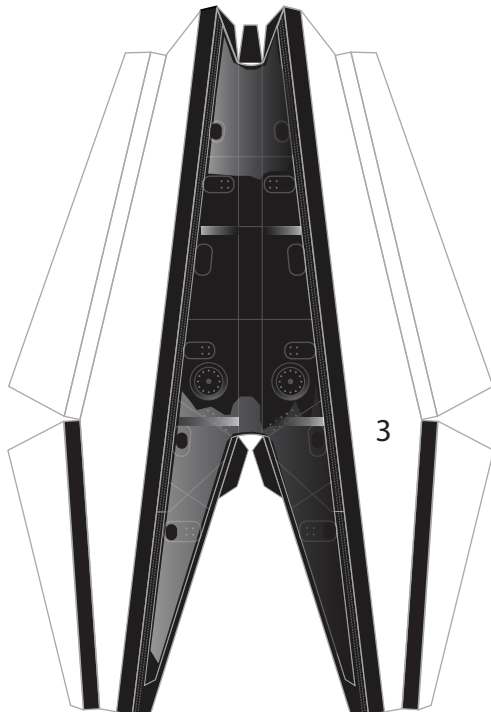
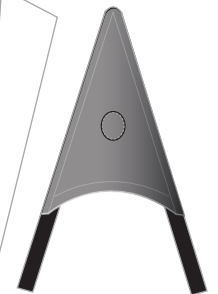
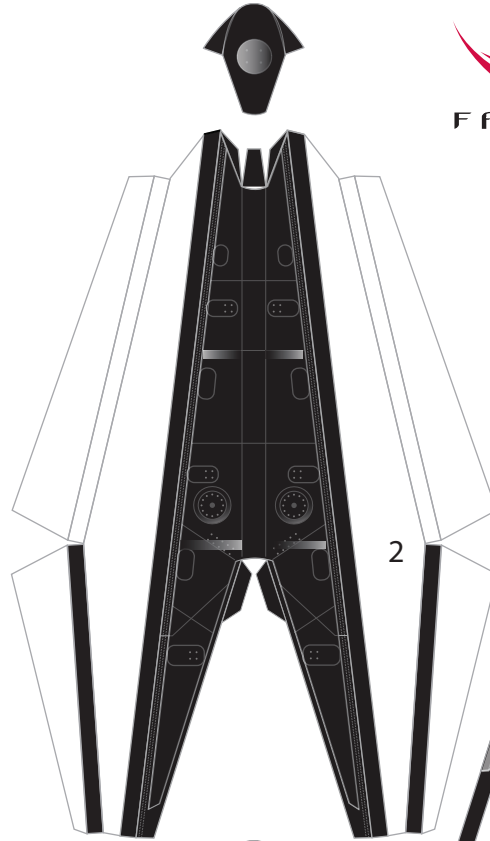
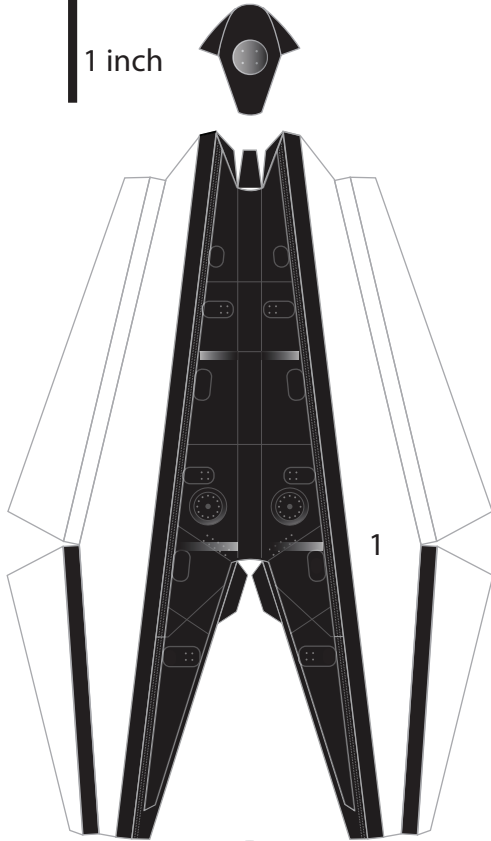
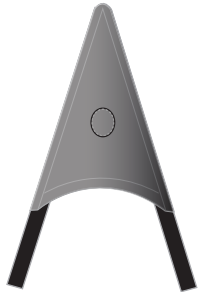



# SPACE-X "Falcon 9 Block 5"

Print on Cardstock (110 lbs)

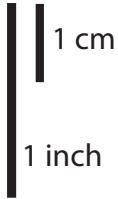

LEGS 2.0 page 2

Rev. 2



1:100 Scale

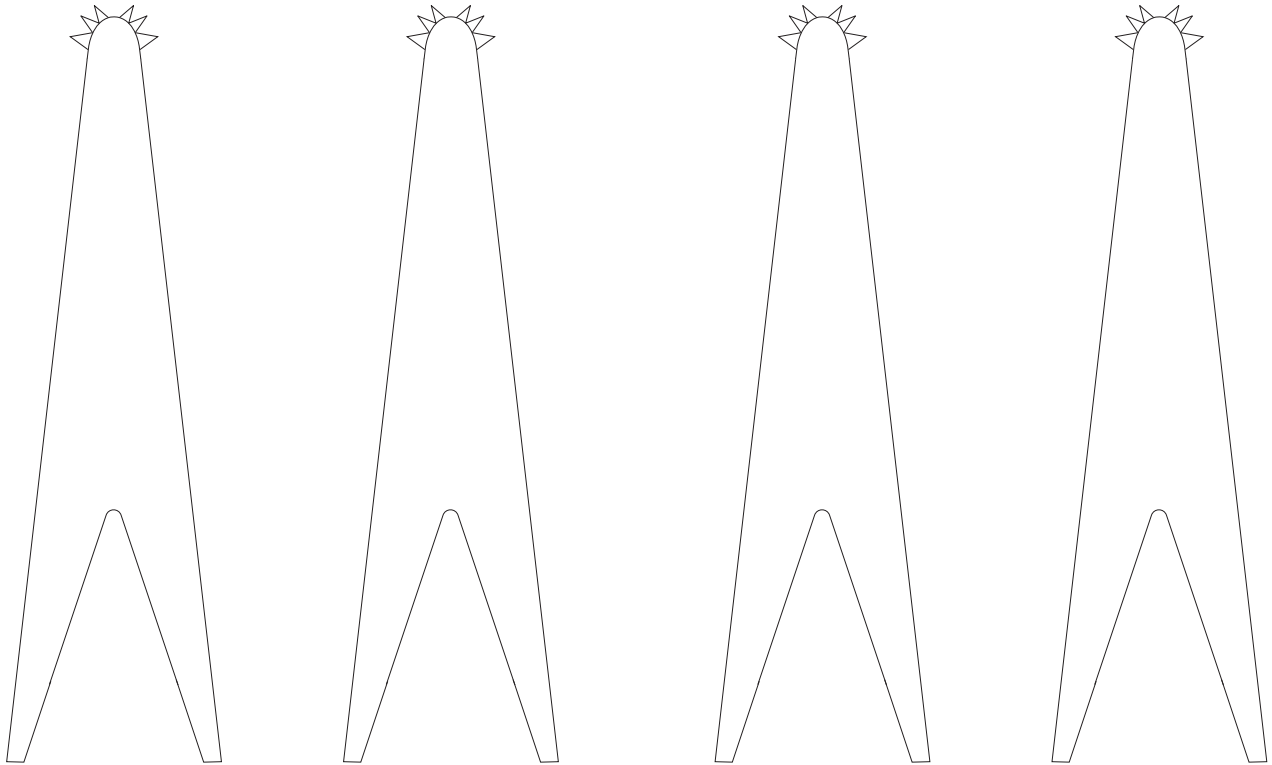

Legs pins

(roll the complete strip and then cut the individual pieces)

## New Leg Hinges

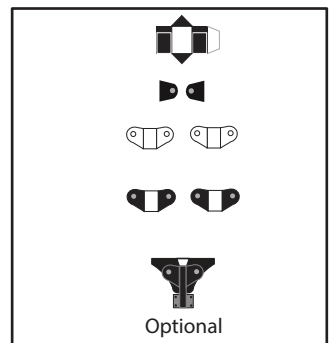
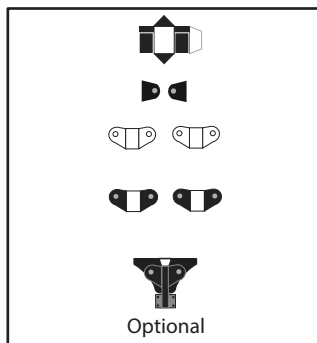
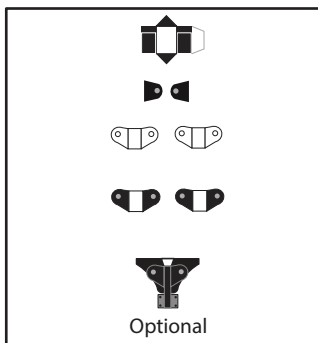
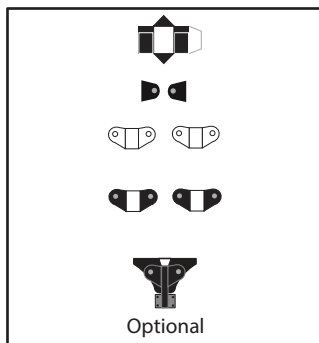



# SPACE-X Falcon 9 Octaweb

Print on Cardstock (110 lbs)

## MERLIN Engines

1:100 Scale

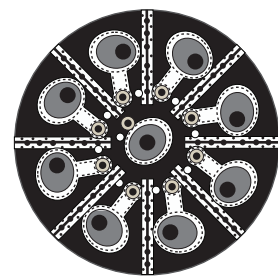
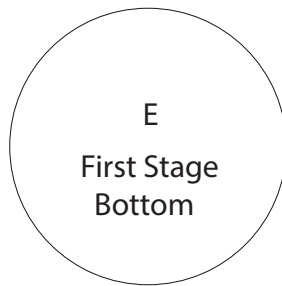
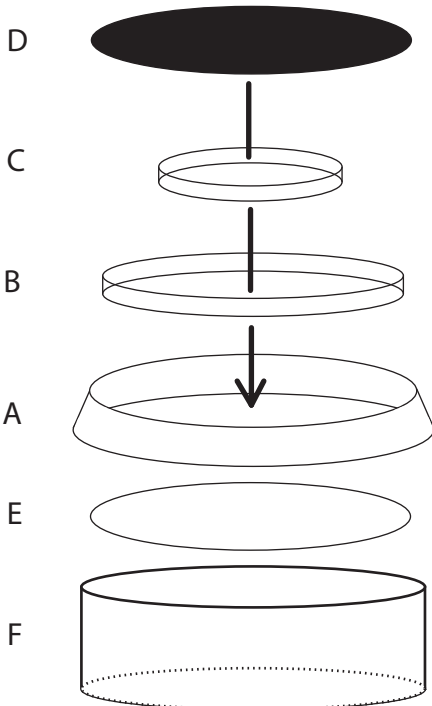
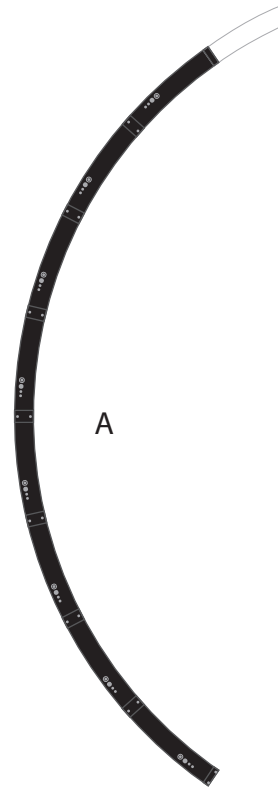
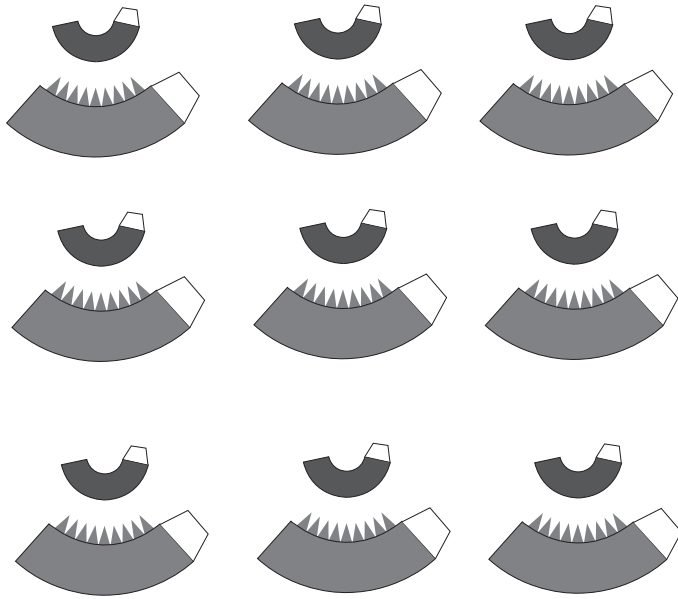

Engine Grid  
OCTAWEB

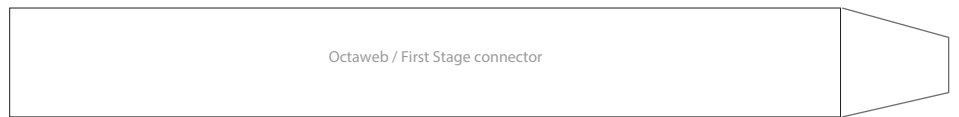





1:100 Scale



SPACE-X "Falcon 9" Octaweb

Print on Cardstock (110 lbs)

MERLIN Engines

BACK PRINT

