



1:100 Scale

SPACE-X "Falcon 9 Fairing 2.0"

Print on Cardstock (110 lbs)



STARLINK-1 Mission 2

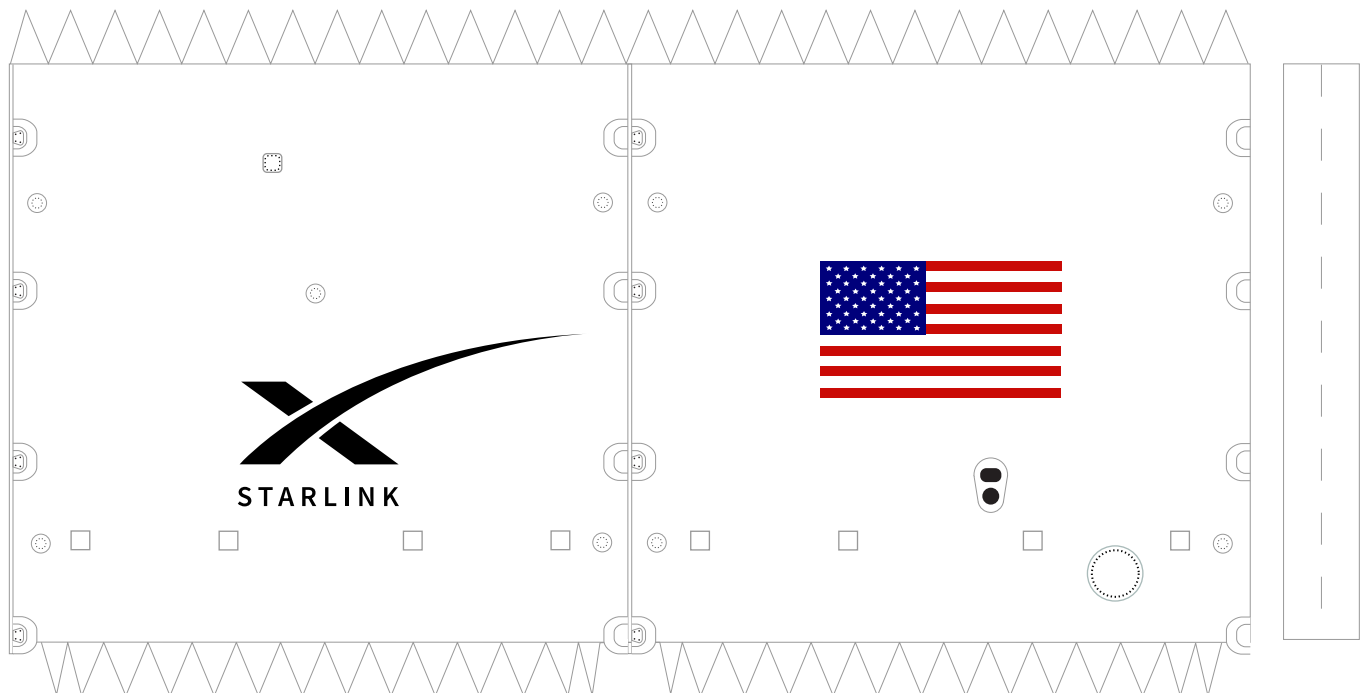
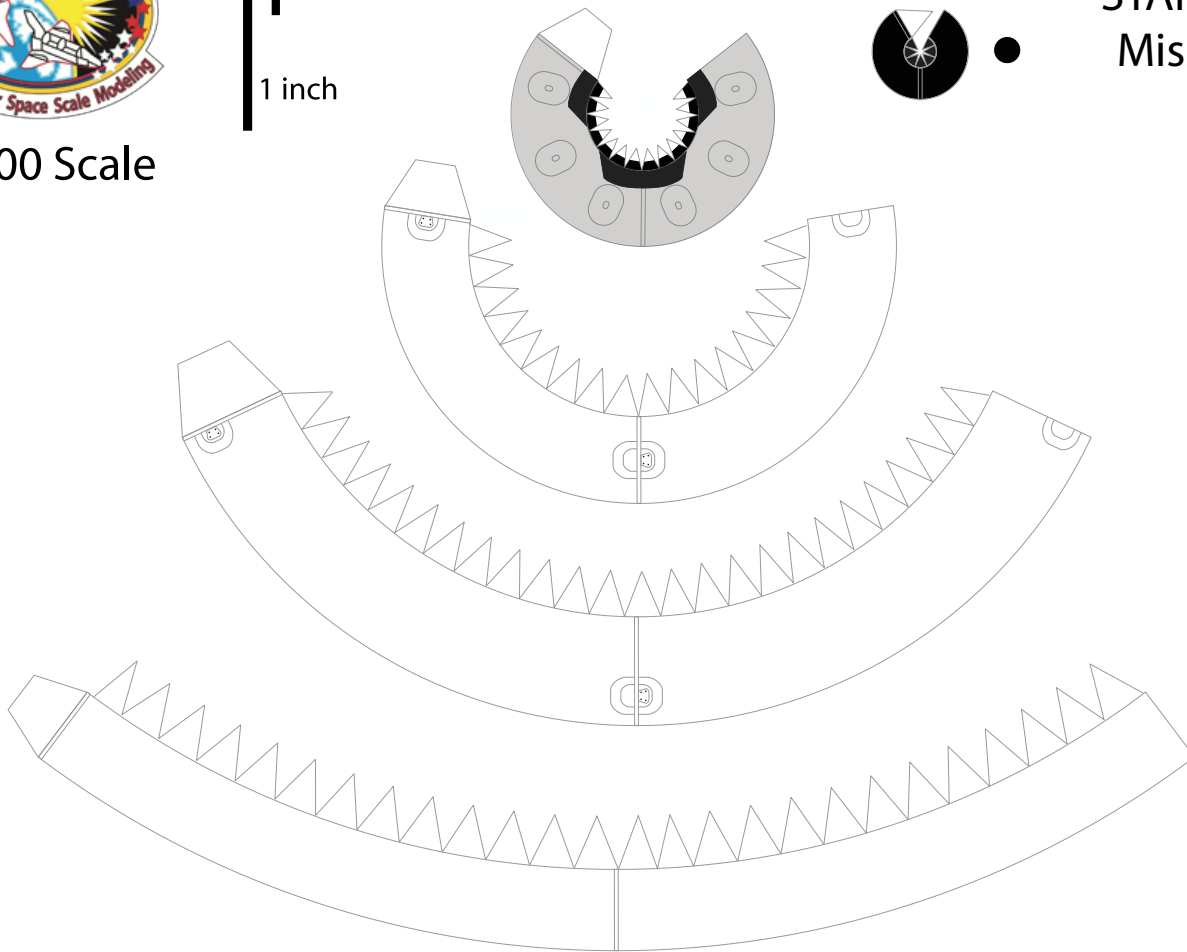



SPACE-X "Falcon 9 Block 5"

Print on Cardstock (110 lbs)

Rev. 2

Enlarged Second Stage / Interstage
Use for Fairing 2.0

Block 5 Second Stage
Titanium Grid Fins

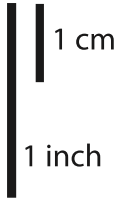

1:100 Scale

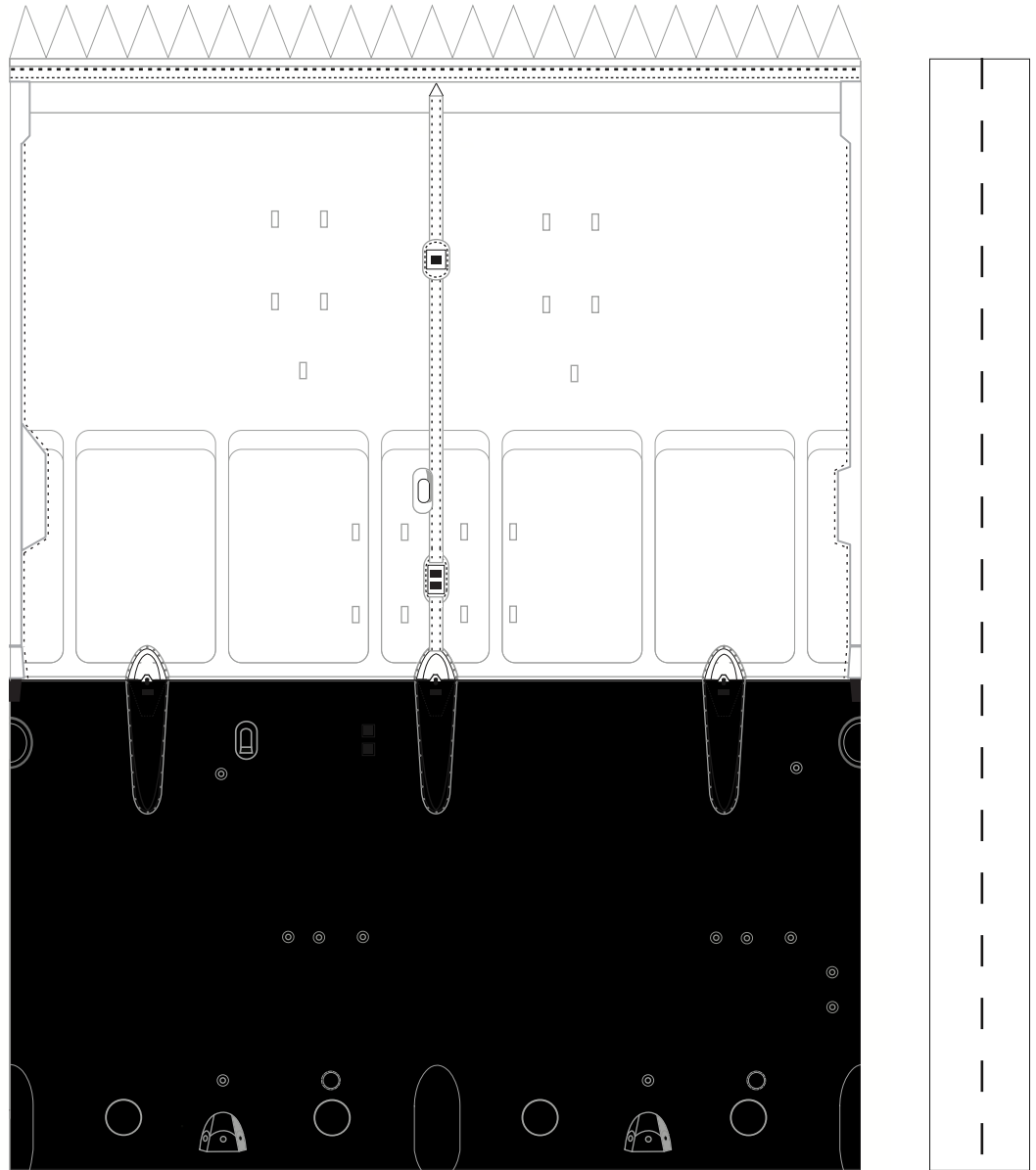
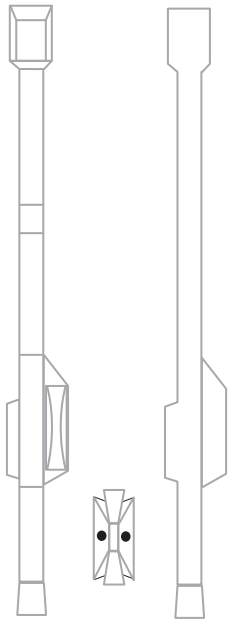

Titanium Grid Fins

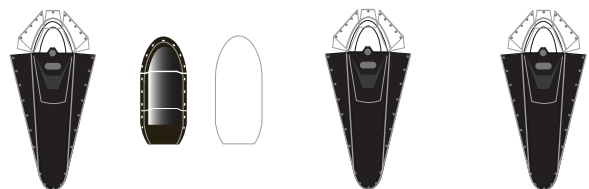
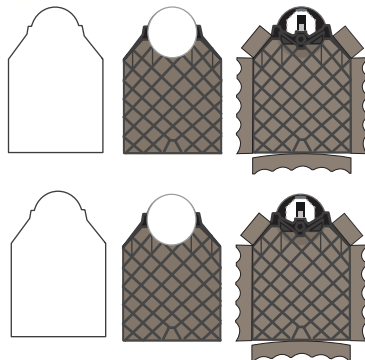
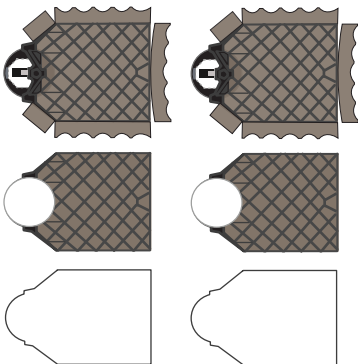



1:100 Scale

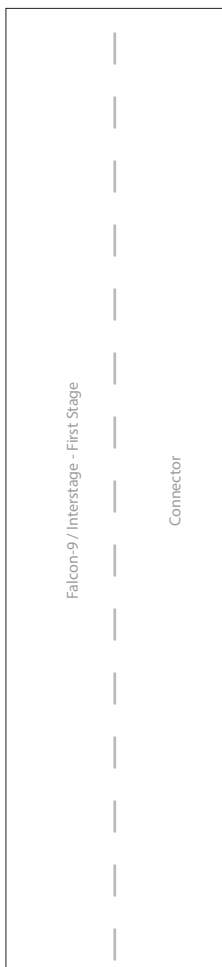

Falcon-9/ Interstage - First Stage

Connector

SPACE-X "Falcon 9 Block 5" Starlink-1 Mission 2

Print on Cardstock (110 lbs)

Block 5

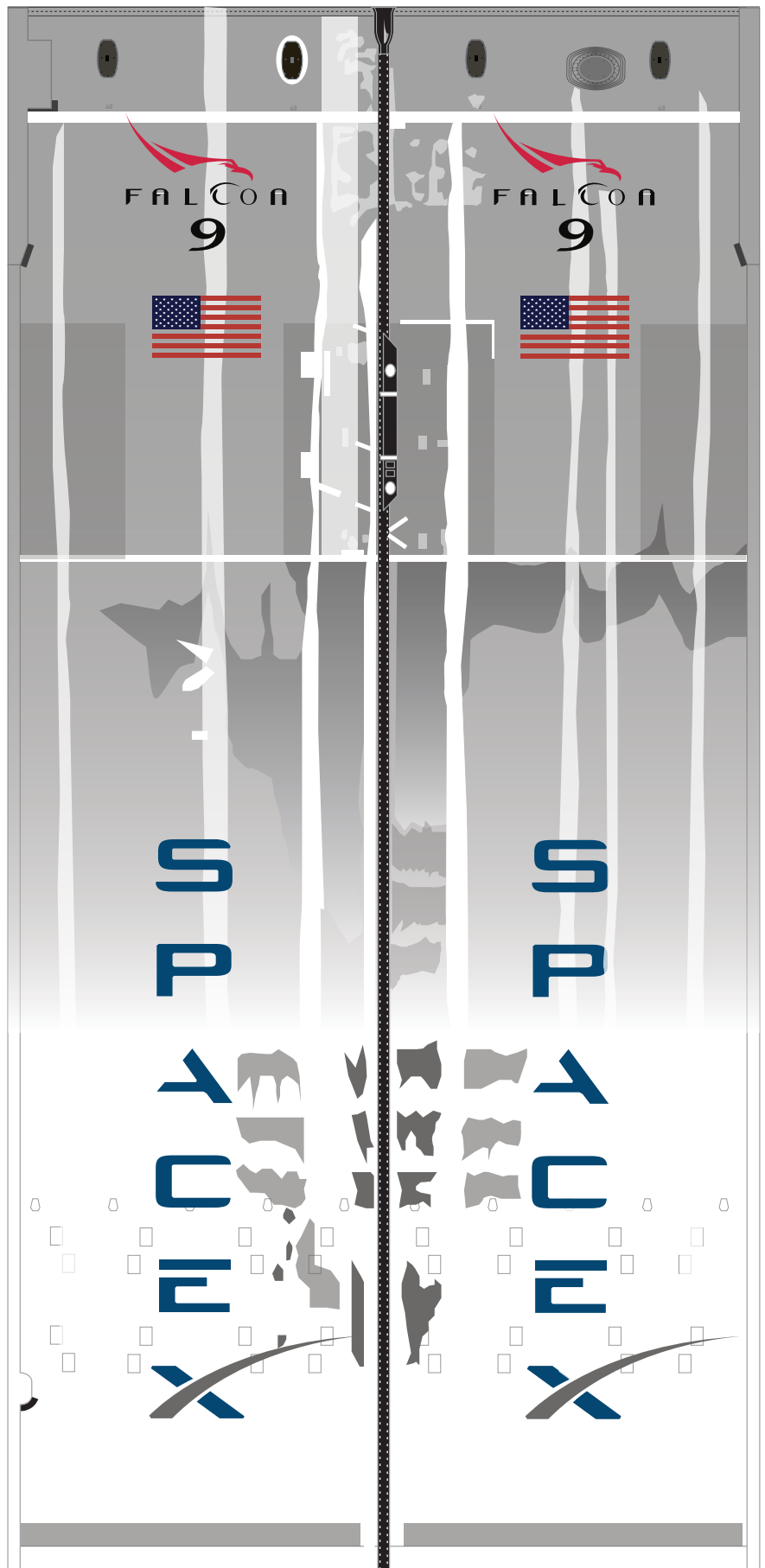



1:100 Scale



FALCON
9

SPACE-X "Falcon 9 Block 5"

Print on Cardstock (110 lbs)

Rev. 1
Block 5

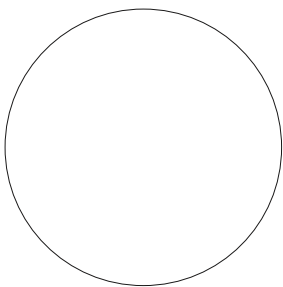
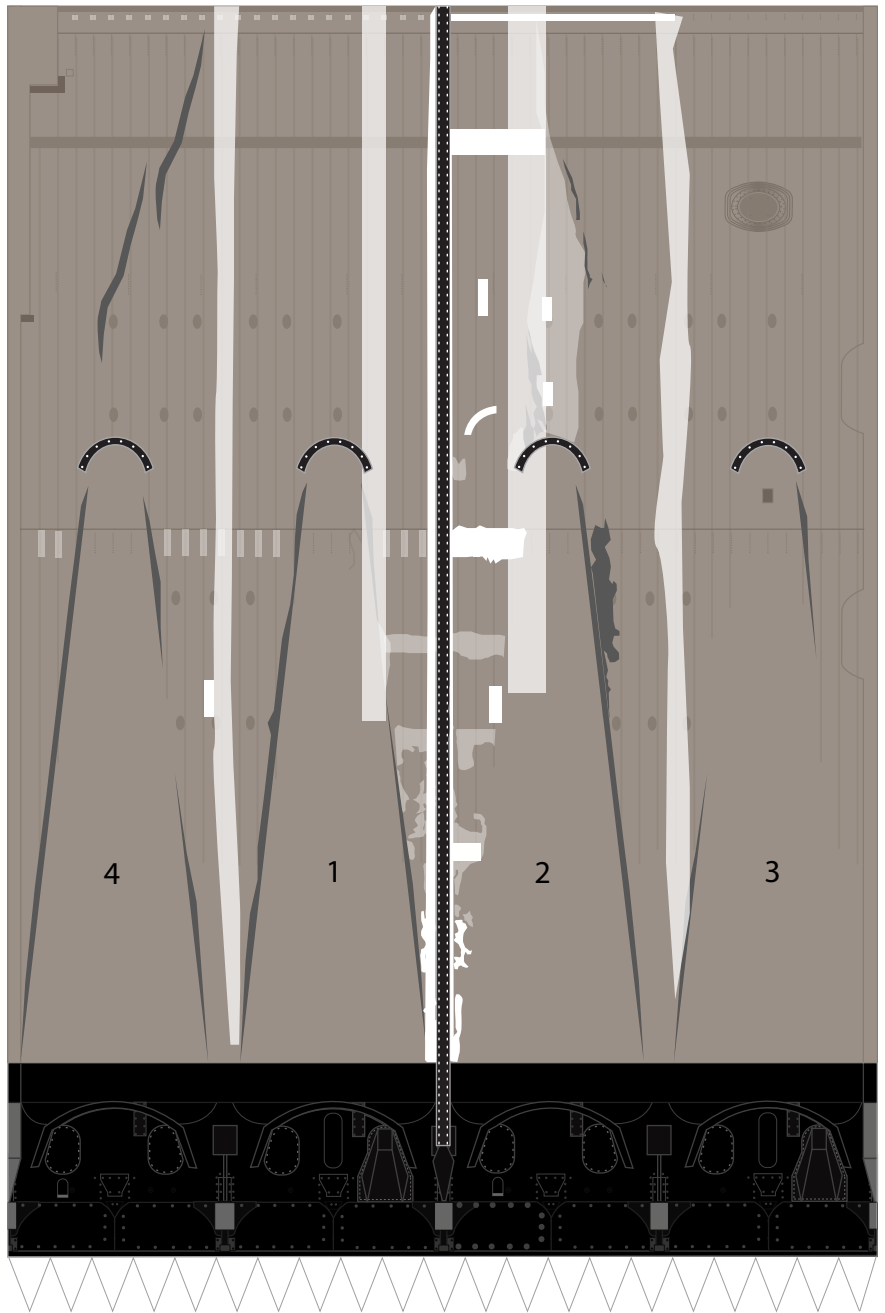
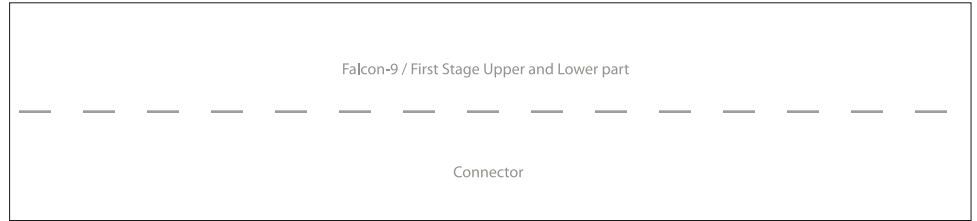
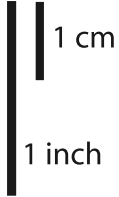



1:100 Scale



SPACE-X "Falcon 9 Block 5"

Print on Cardstock (110 lbs)

BLOCK 5

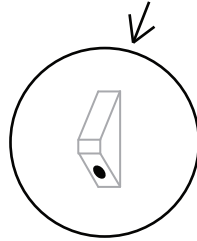

Thicker Raceway



bottom

Fairing Connector 2.0

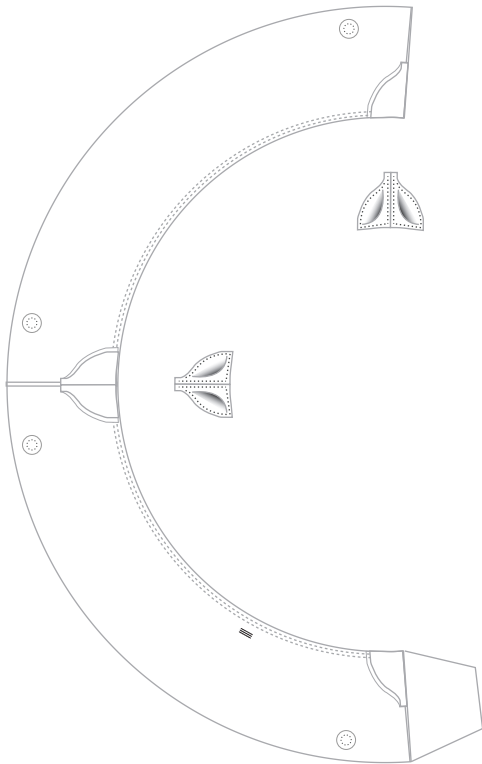



SPACE-X "Falcon-9 Block 5"

Print on Cardstock (110 lbs)

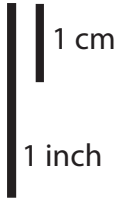

LEGS 2.0

Starlink



1:100 Scale

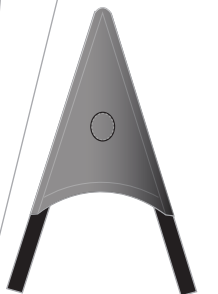
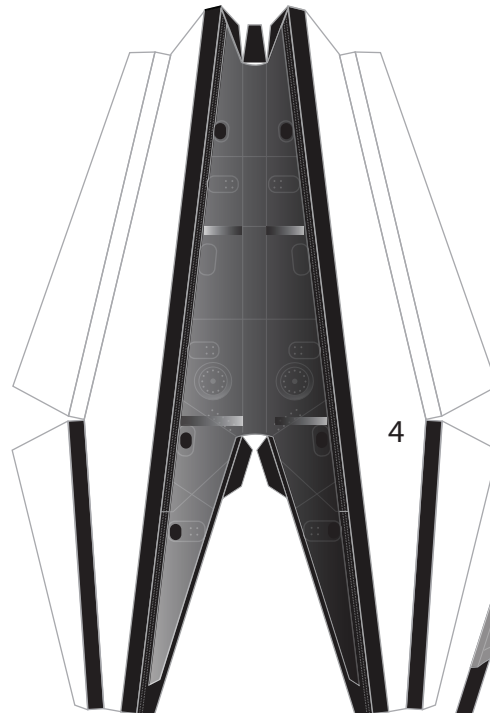
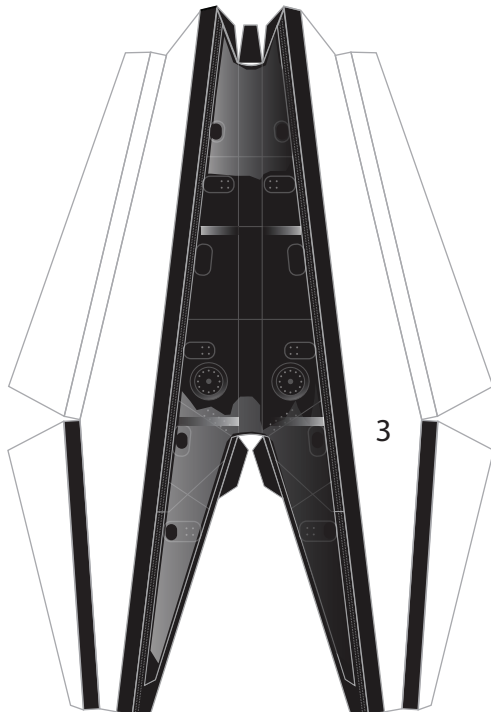
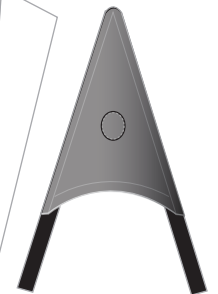
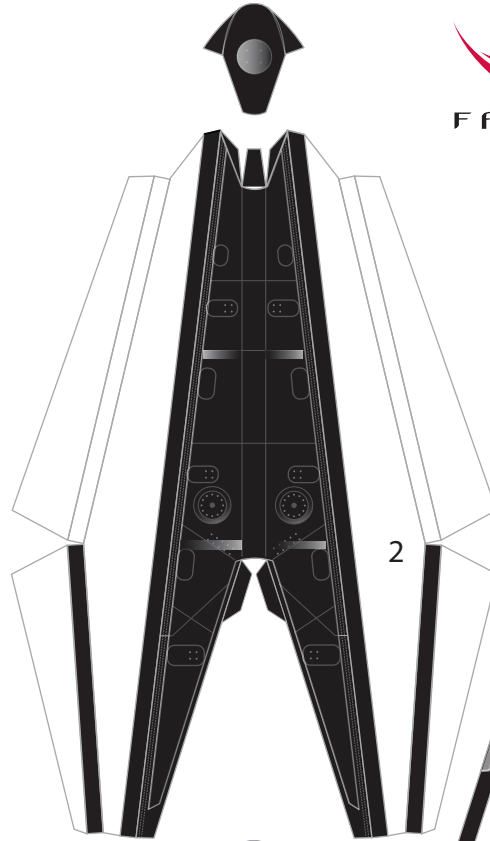
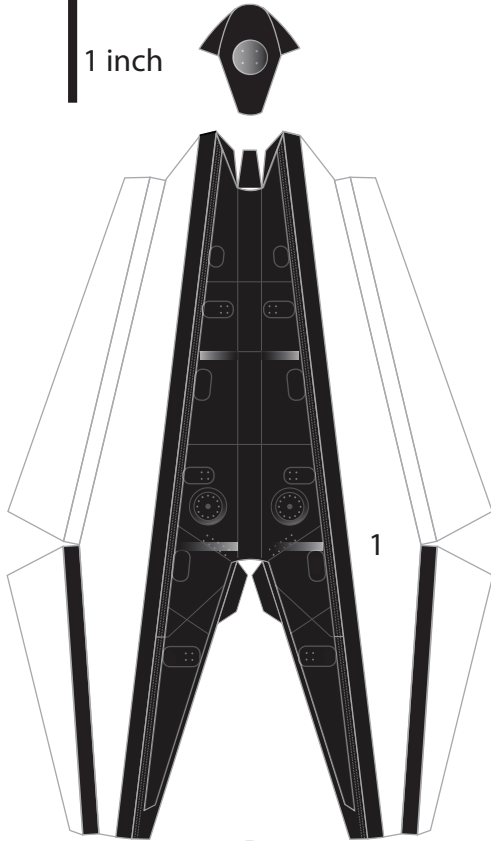
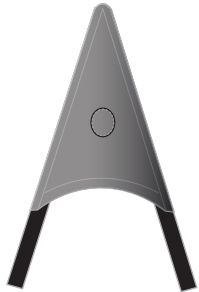



SPACE-X "Falcon 9 Block 5"

Print on Cardstock (110 lbs)



LEGS 2.0 page 2

Rev. 2



1:100 Scale

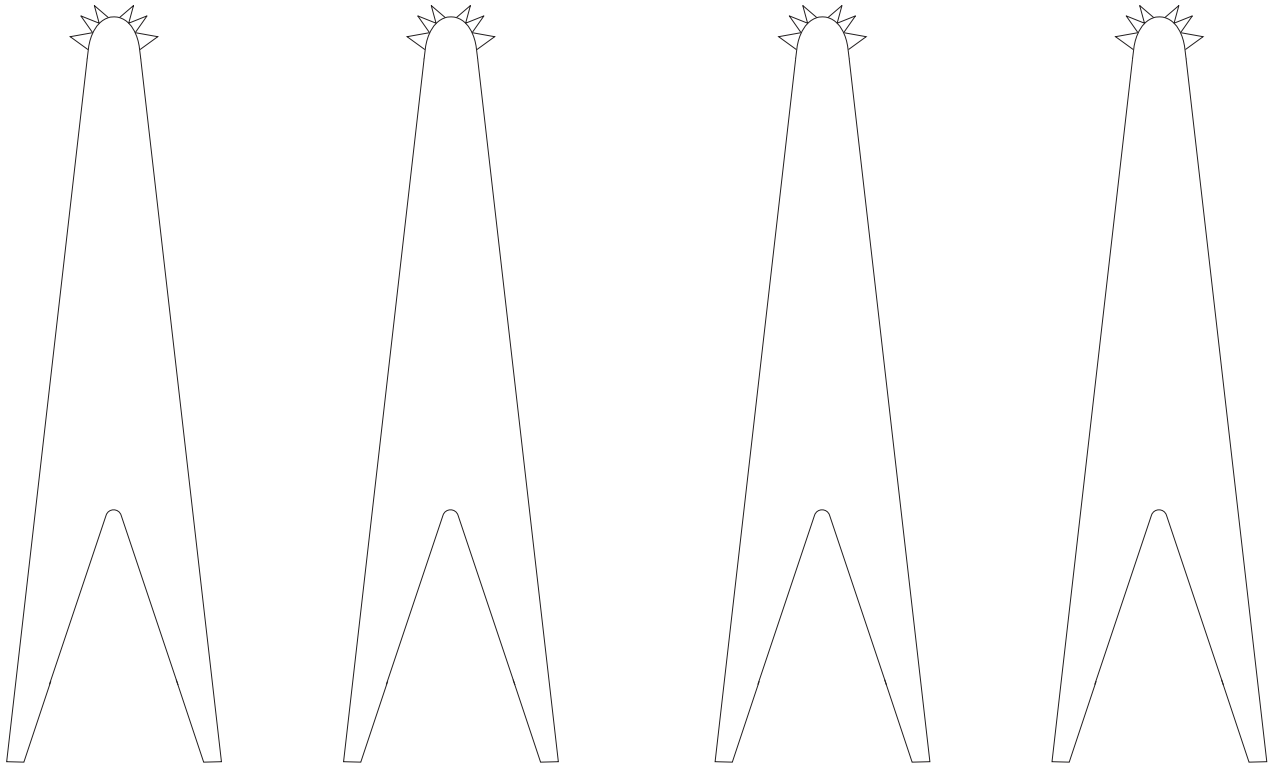

Legs pins

(roll the complete strip and then cut the individual pieces)

New Leg Hinges

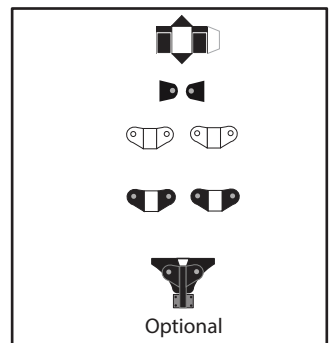
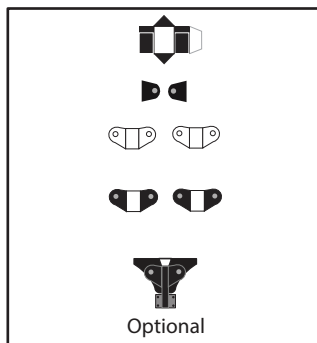
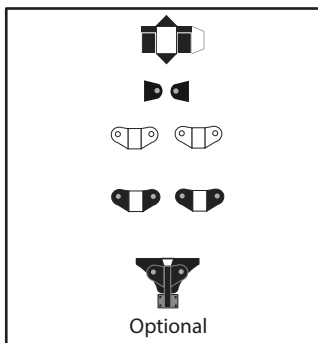
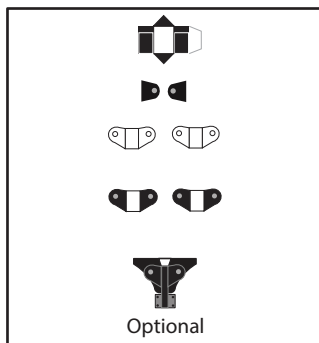



1:100 Scale



SPACE-X "Falcon 9 Block 5"

MERLIN Engines

Print on Cardstock (110 lbs)

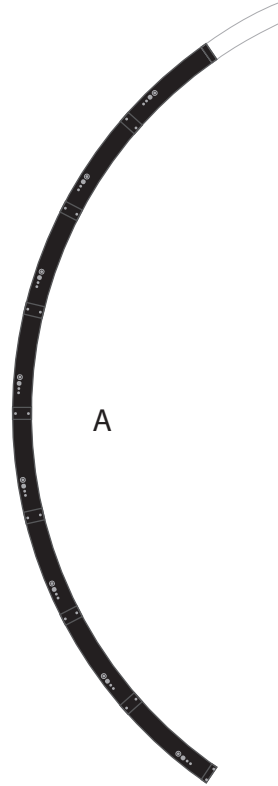
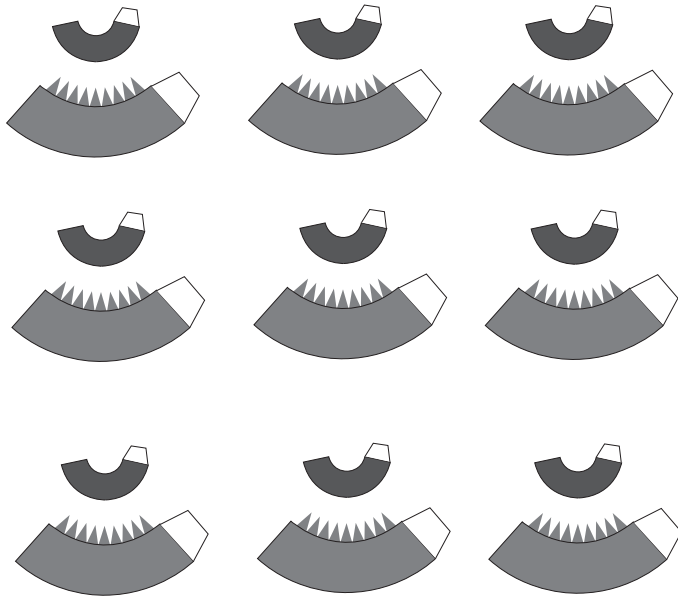

C

B

A

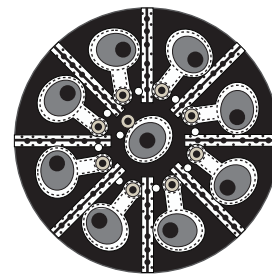
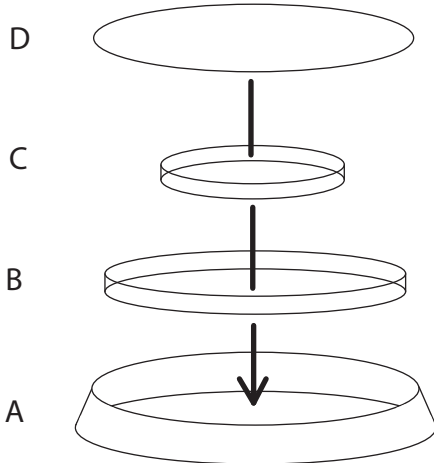

D

Engine Grid
OCTAWEB



1:100 Scale



SPACE-X "Falcon 9 Block 5"

Print on Cardstock (110 lbs)

MERLIN Engines

BACK PRINT

