

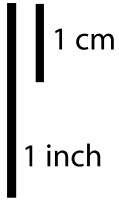

SPACE-X "Falcon 9 Fairing 2.0"

Print on Cardstock (110 lbs)



STARLINK-2

1:100 Scale

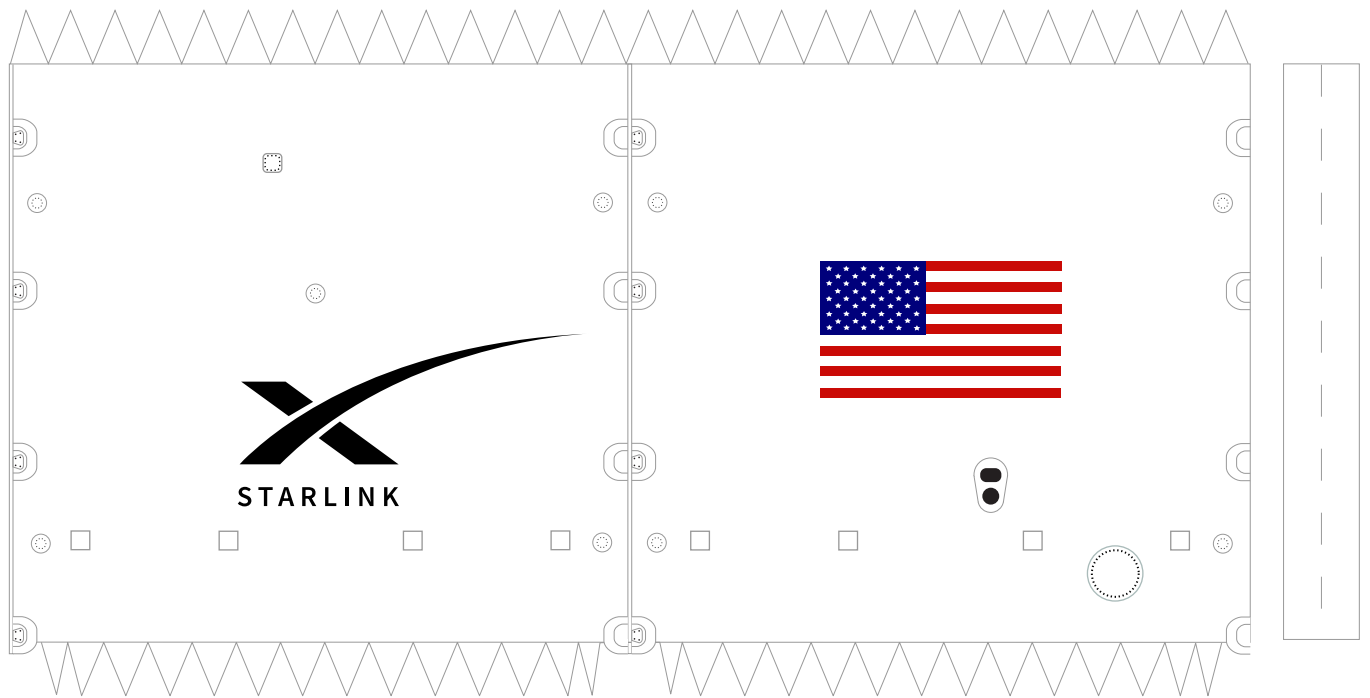
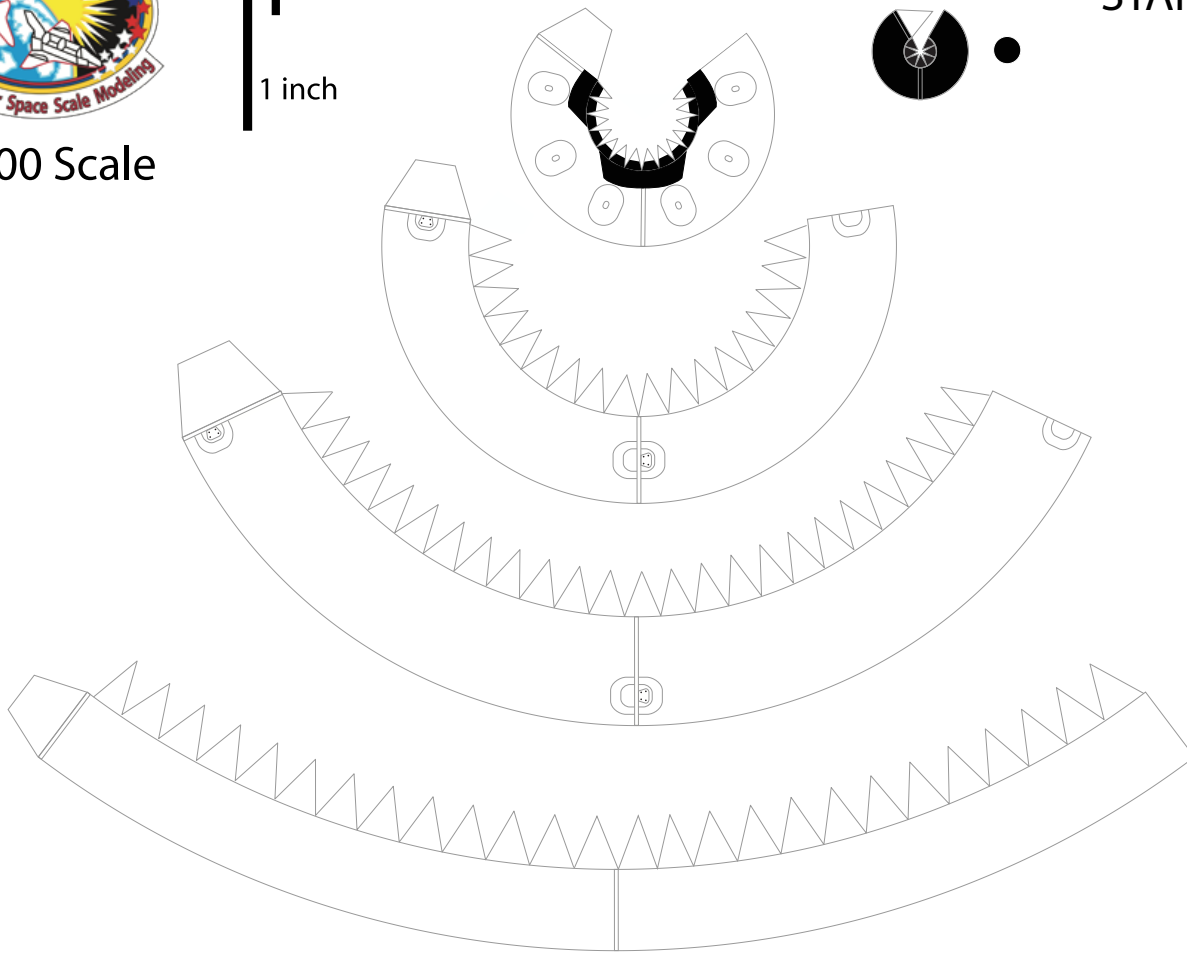



SPACE-X "Falcon 9 Block 5"

Print on Cardstock (110 lbs)

Rev. 2

Enlarged Second Stage / Interstage
Use for Fairing 2.0

Block 5 Second Stage
Titanium Grid Fins

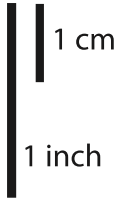

1:100 Scale

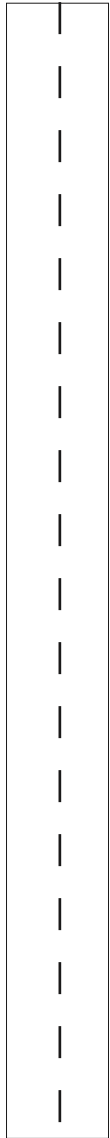
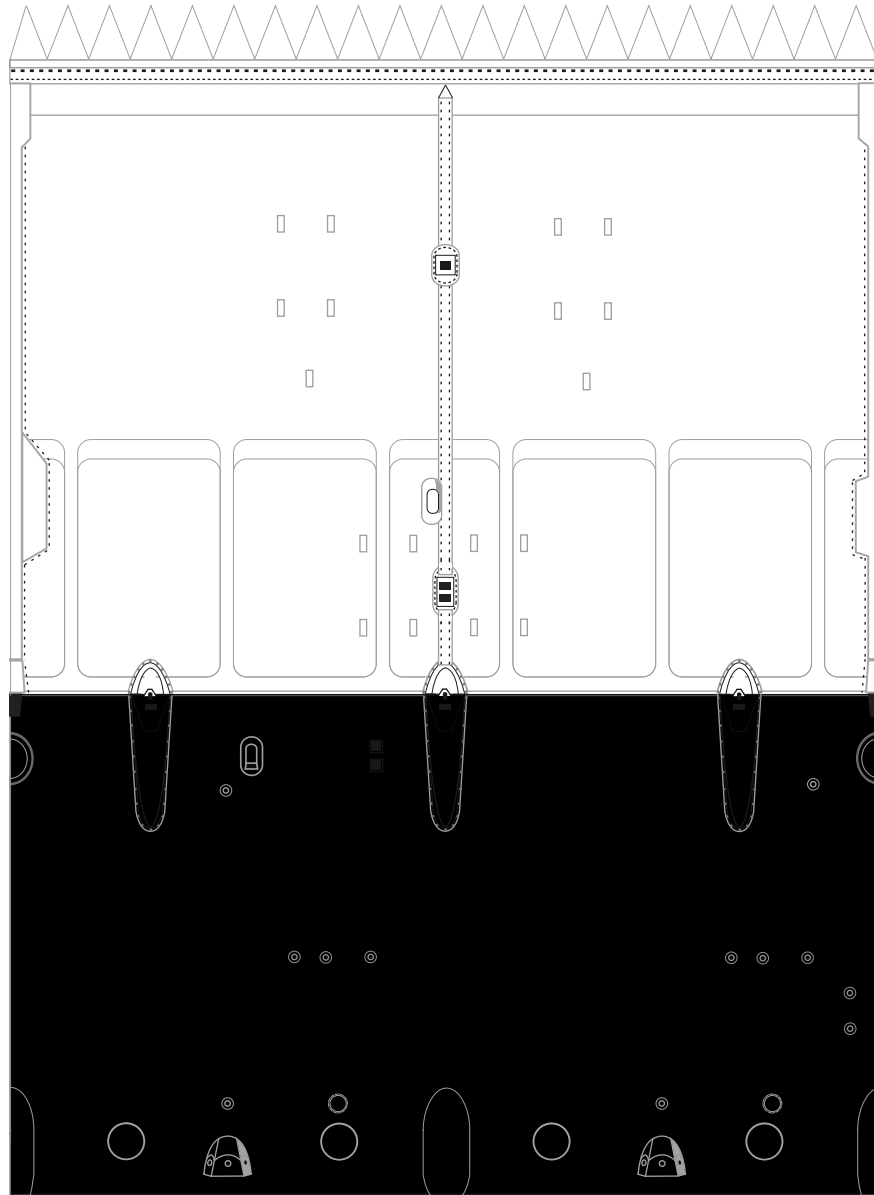
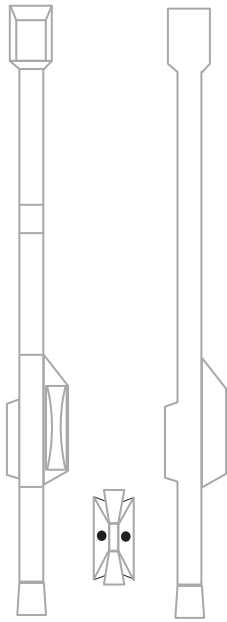

Titanium Grid Fins

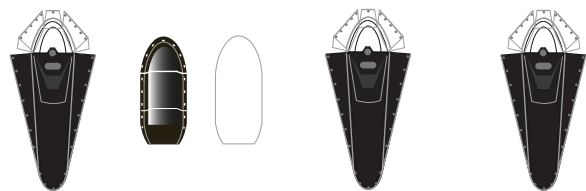
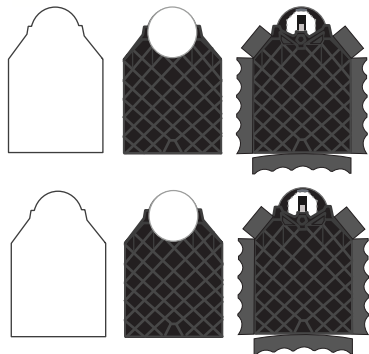
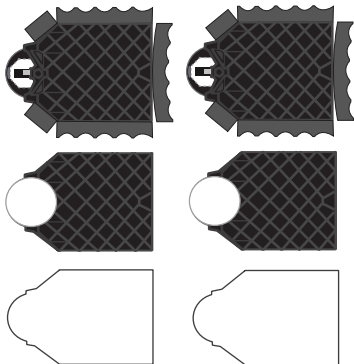



1:100 Scale

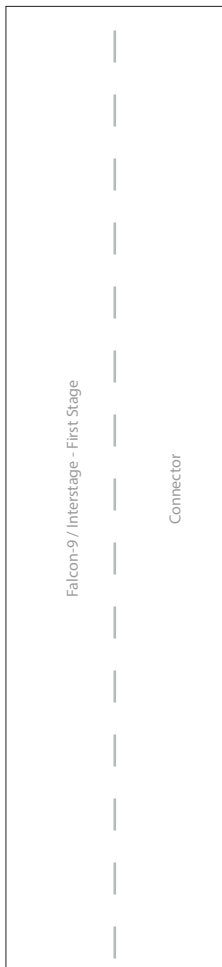

SPACE-X "Falcon 9 Block 5" Starlink-2

Print on Cardstock (110 lbs)

Block 5

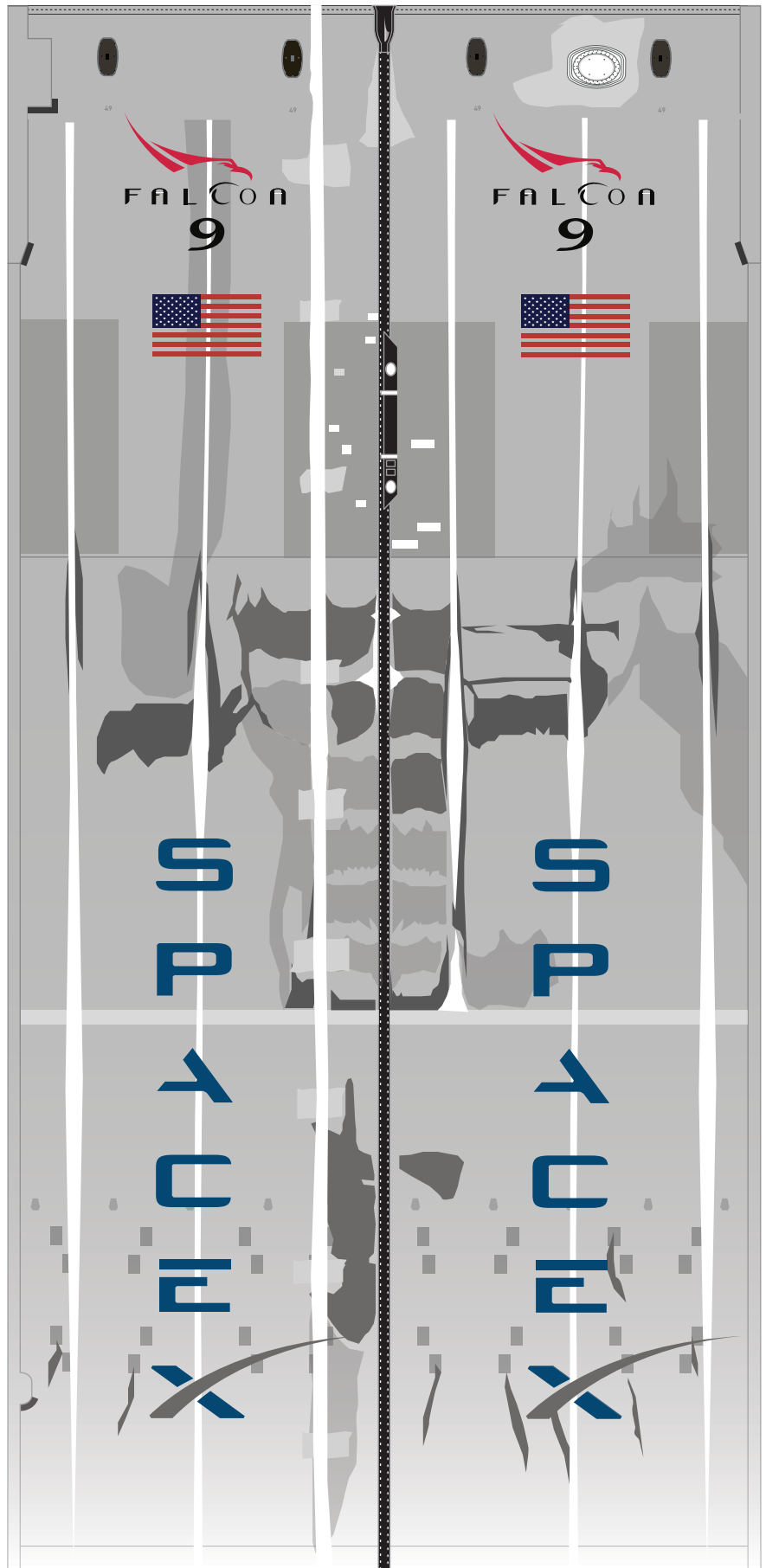



1:100 Scale



FALCON
9

SPACE-X "Falcon 9 Block 5"

Print on Cardstock (110 lbs)

Starlink-2

Rev. 1
Block 5

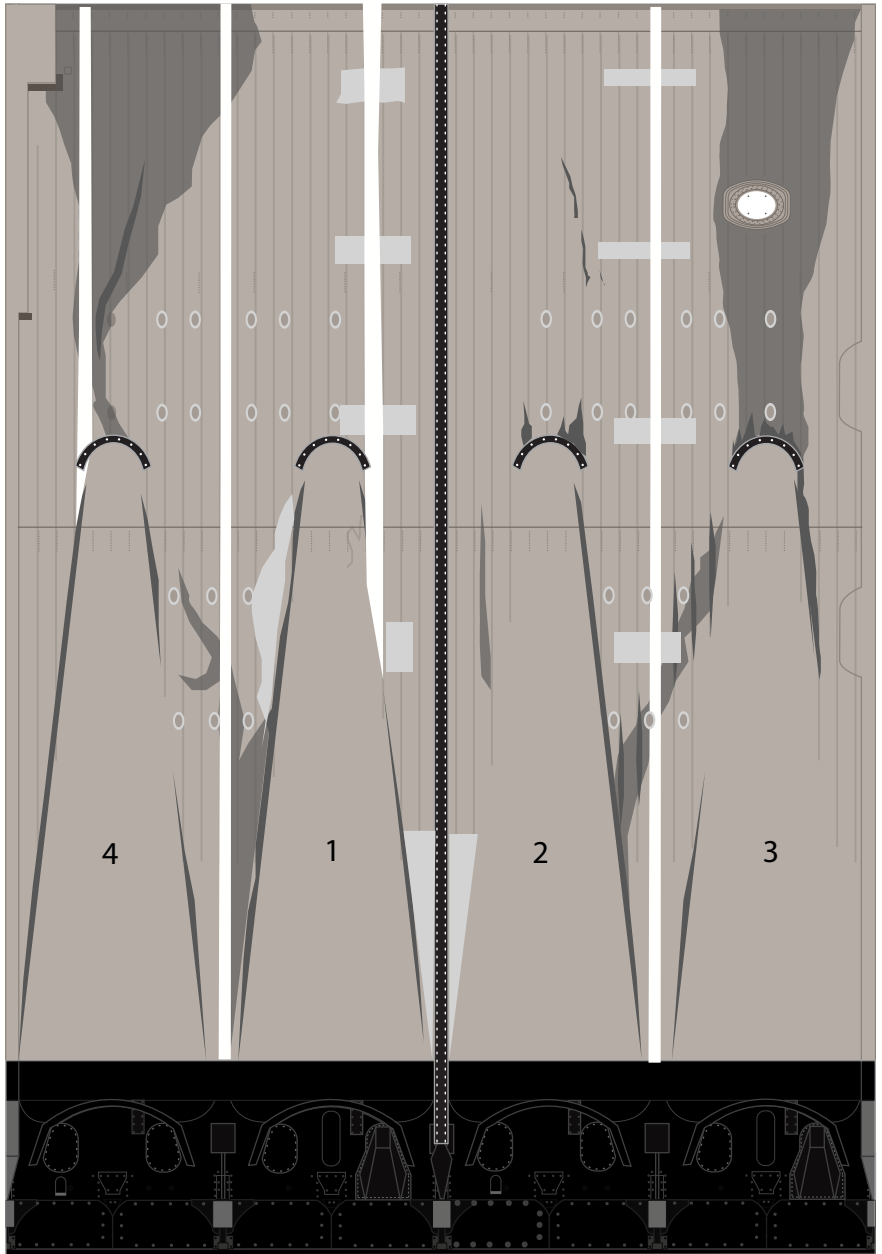
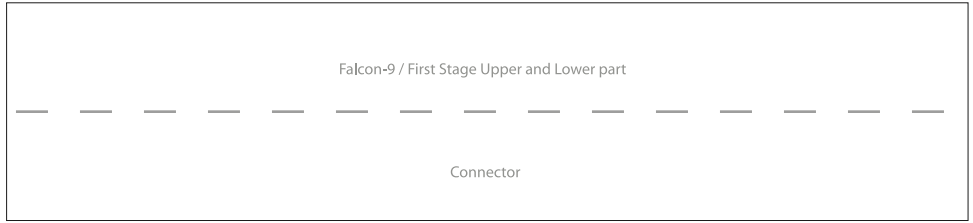
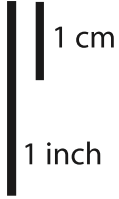



1:100 Scale



SPACE-X "Falcon 9 Block 5"

Print on Cardstock (110 lbs)

BLOCK 5

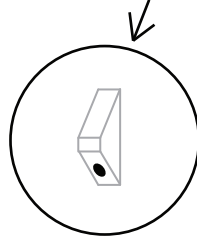

Thicker Raceway



bottom

Fairing Connector 2.0

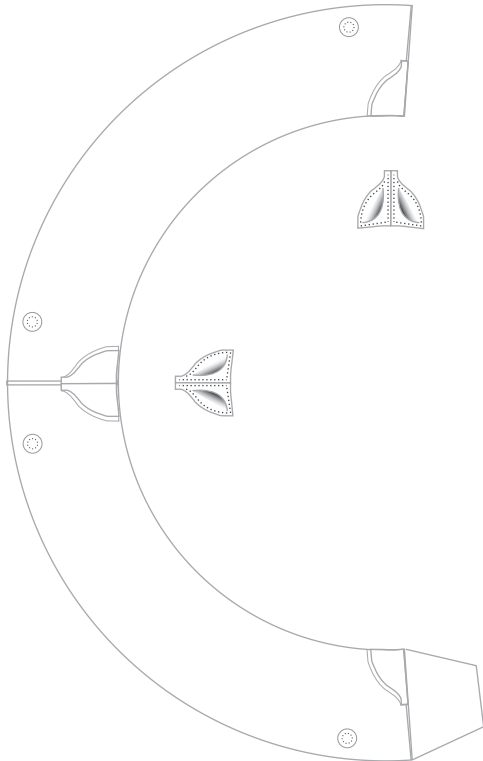



1:100 Scale

SPACE-X "Falcon-9 Block 5"

Print on Cardstock (110 lbs)

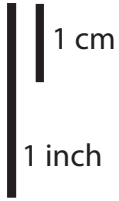

LEGS 2.0

Starlink

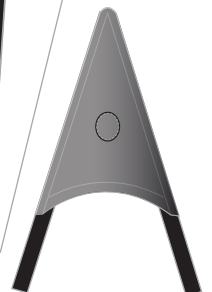
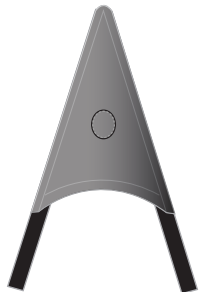
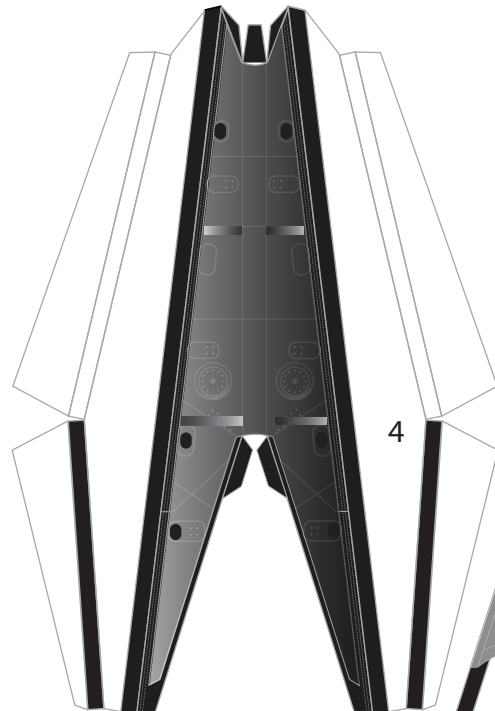
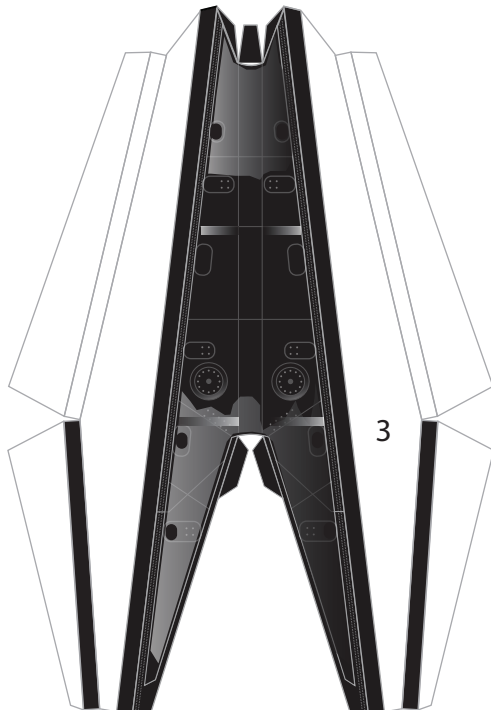
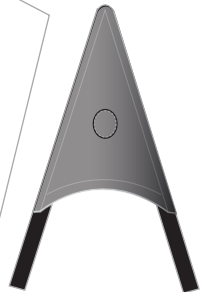
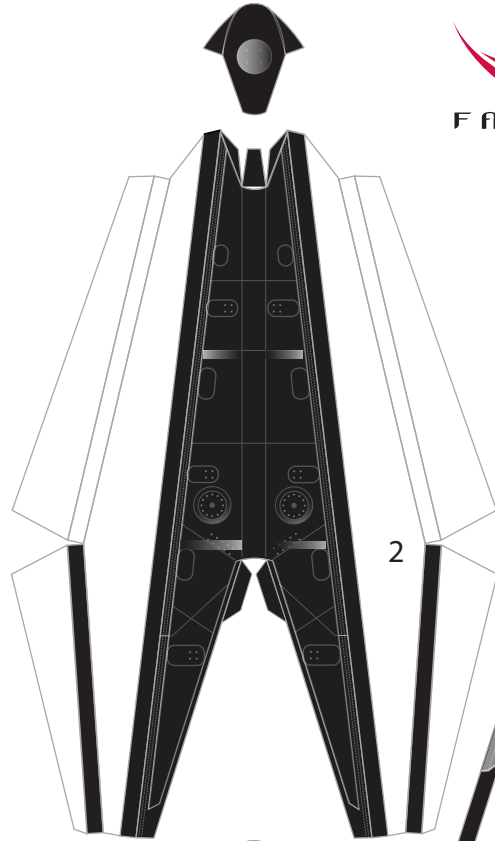
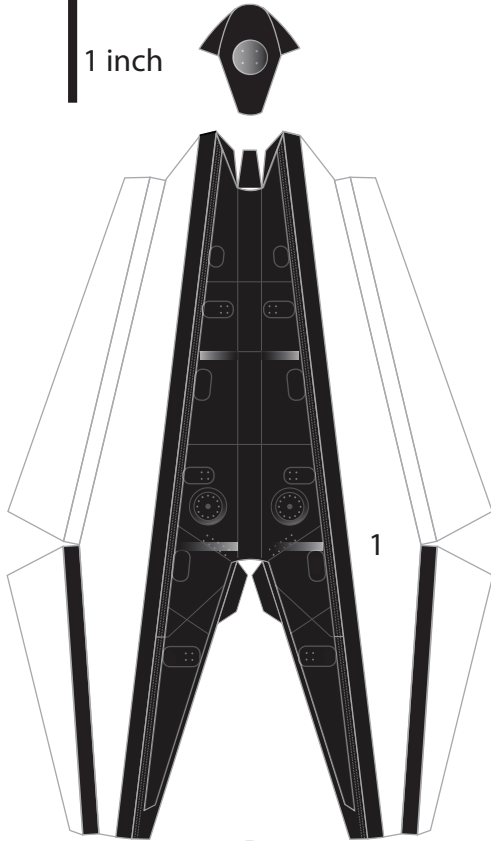
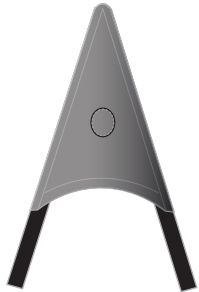



SPACE-X "Falcon 9 Block 5"

Print on Cardstock (110 lbs)

Rev. 2

LEGS 2.0 page 2



1:100 Scale

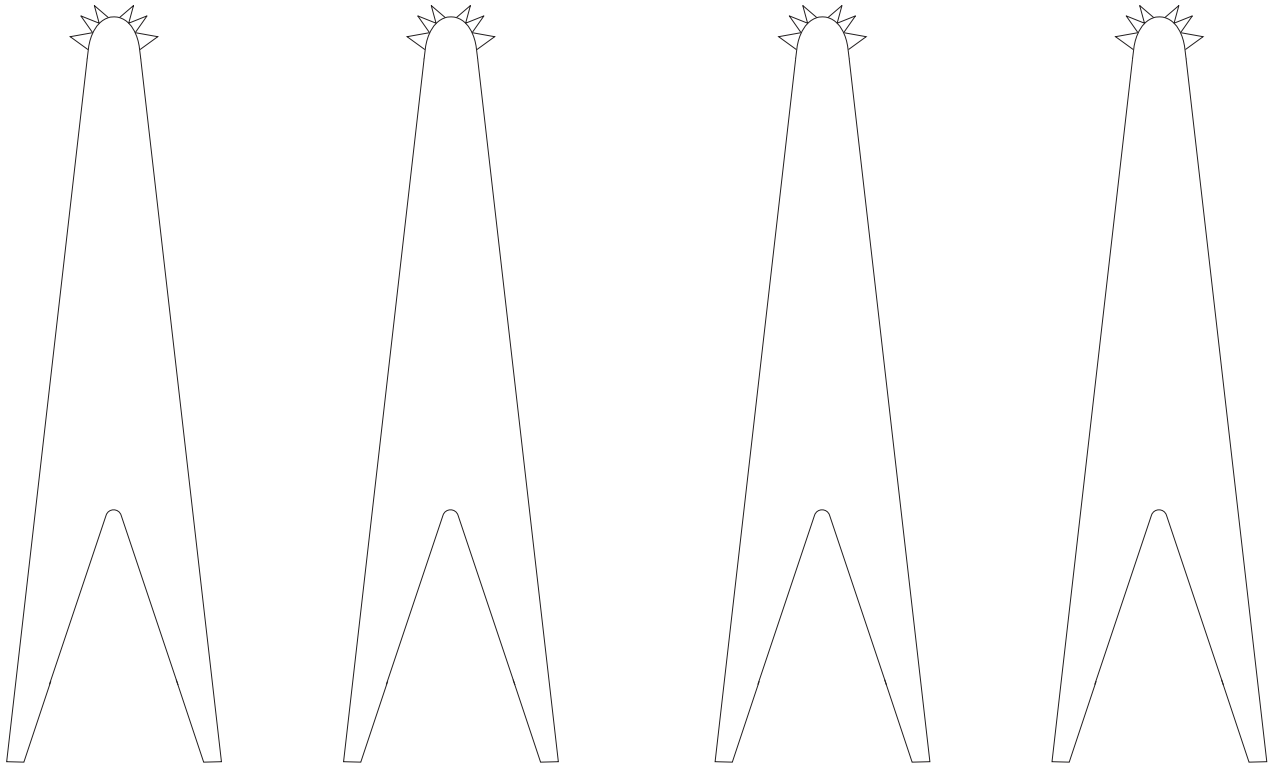

Legs pins

(roll the complete strip and then cut the individual pieces)

New Leg Hinges

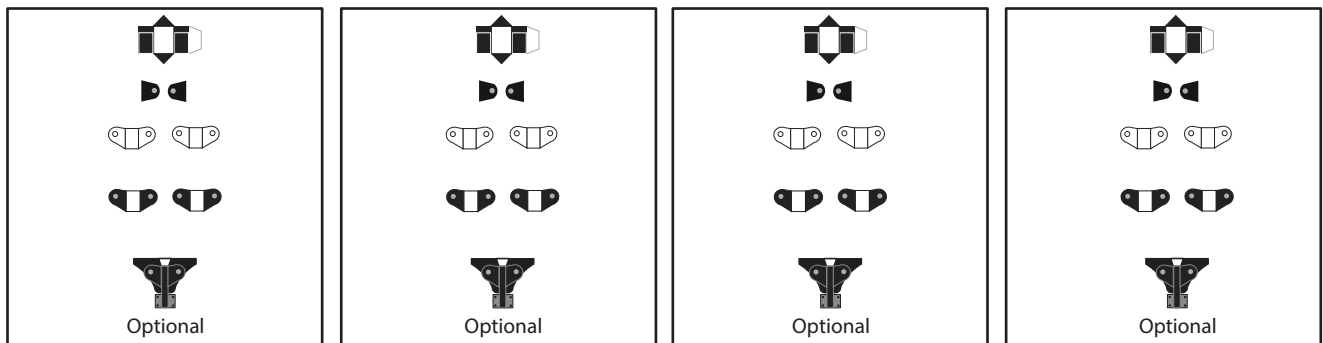



SPACE-X Falcon 9 Octaweb

Print on Cardstock (110 lbs)

MERLIN Engines

1:100 Scale

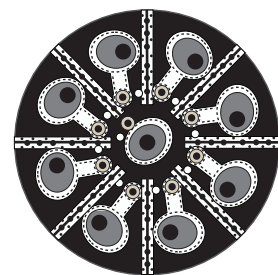
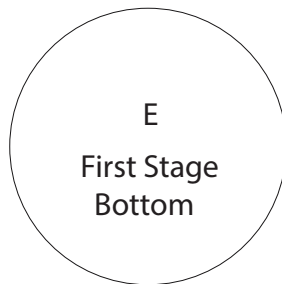
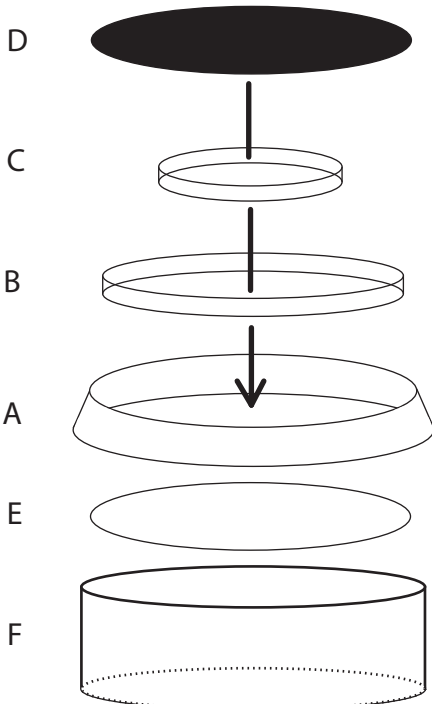
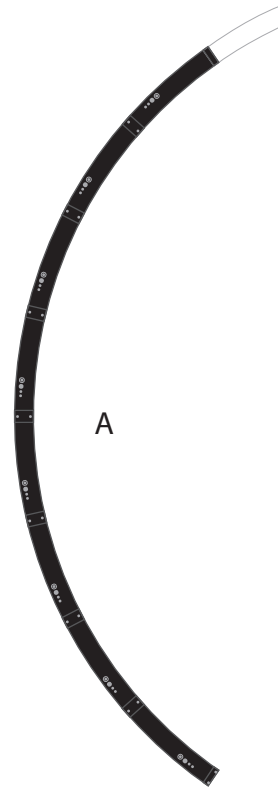
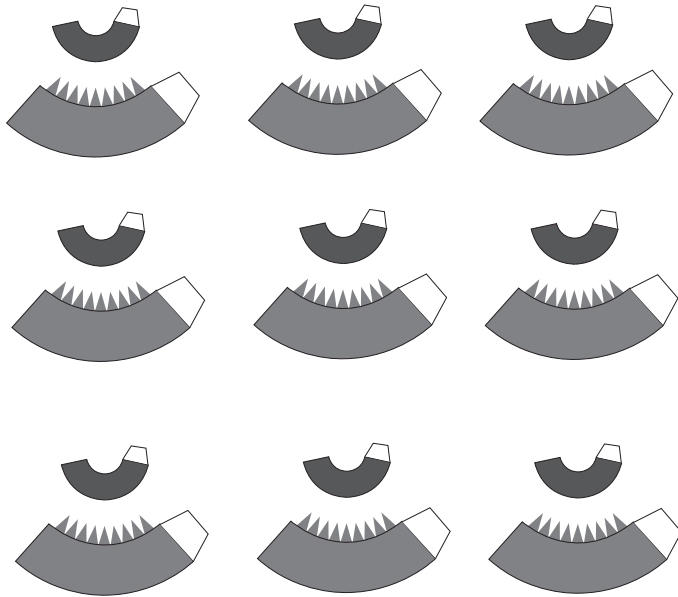

Engine Grid
OCTAWEB

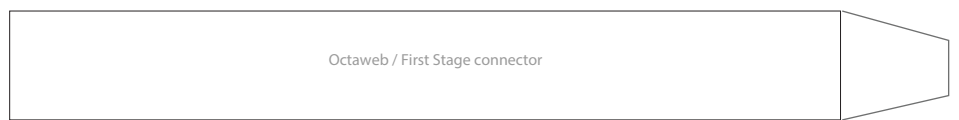



1:100 Scale

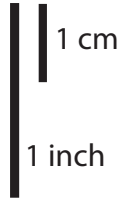

SPACE-X "Falcon 9" Octaweb

Print on Cardstock (110 lbs)

MERLIN Engines

BACK PRINT

