

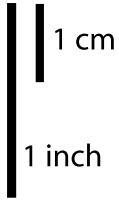

# SPACE-X "Falcon 9 Fairing 2.0"

Print on Cardstock (110 lbs)

## STP-2



1:100 Scale

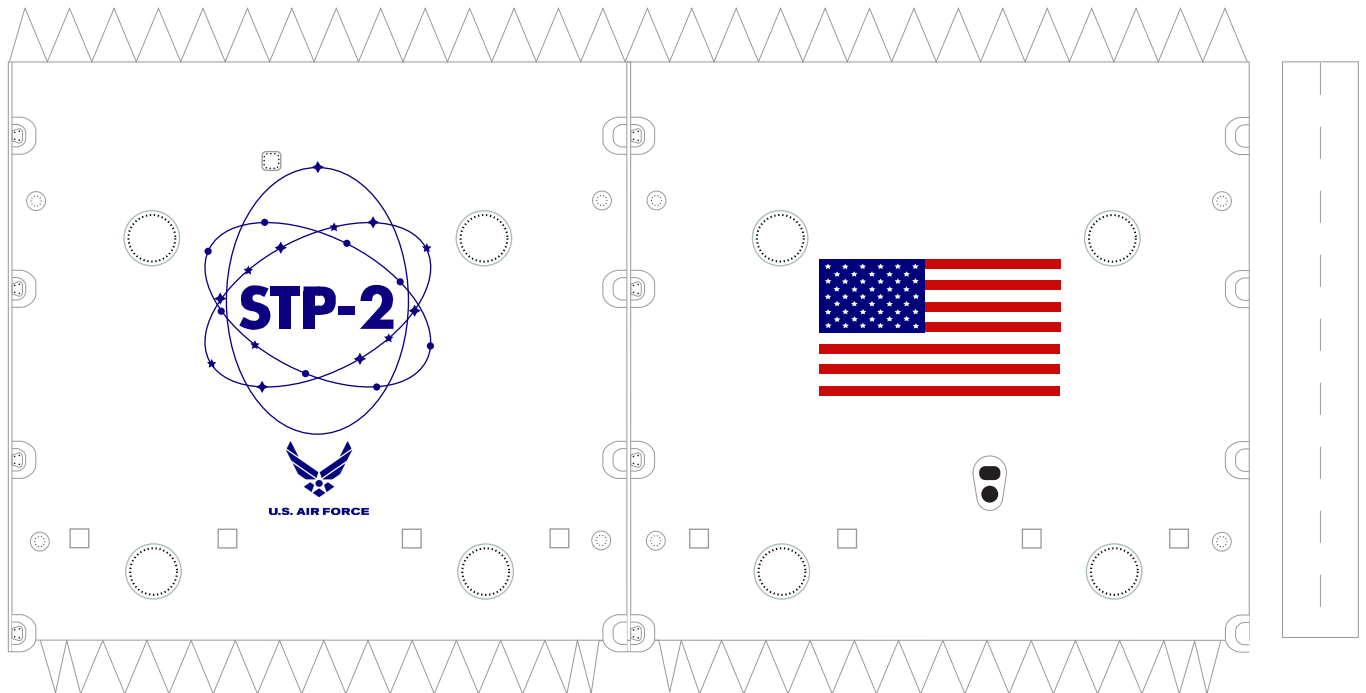
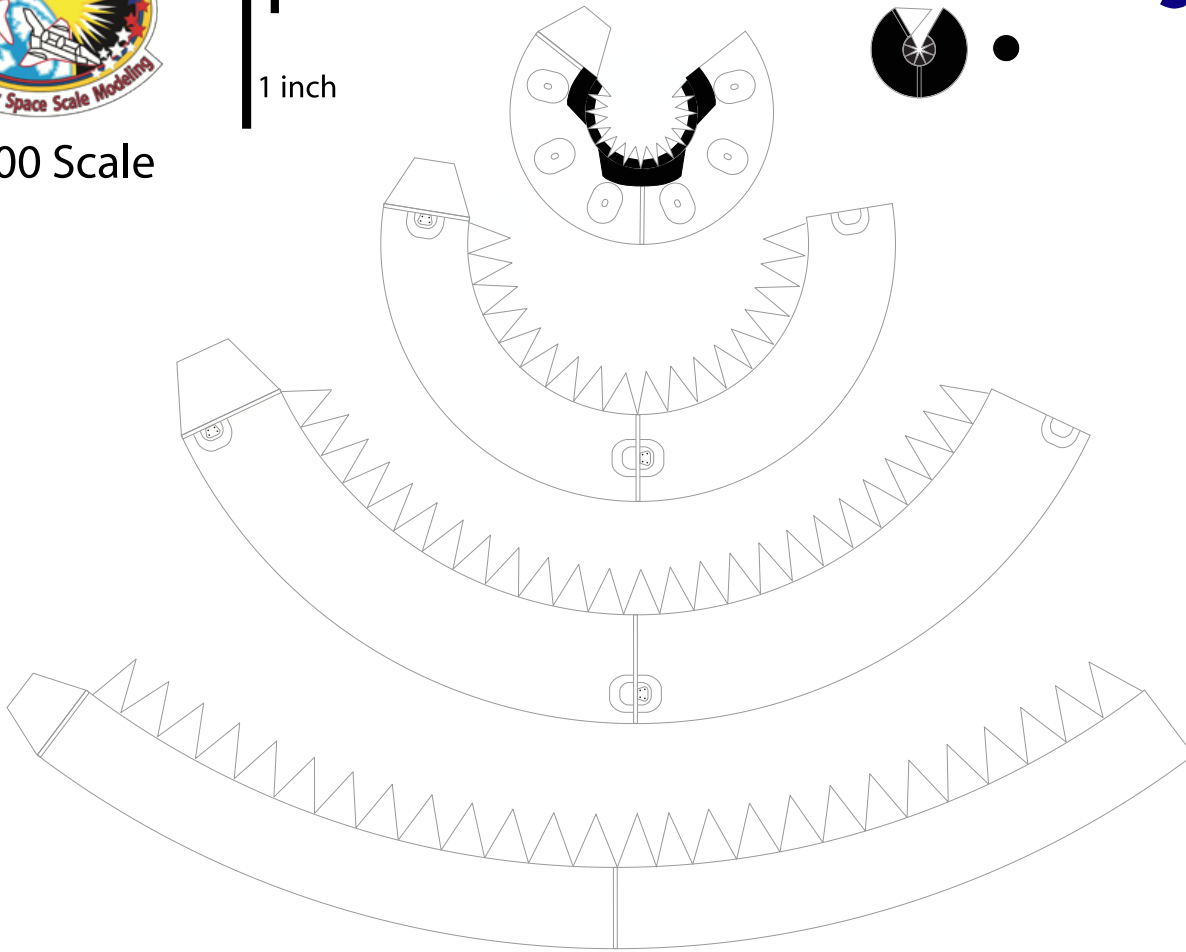

AXM Artwork



# SPACE-X "Falcon Heavy"

Print on Cardstock (110 lbs)

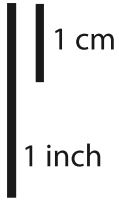

## Separate Block 5 Second Stage and MVac Engine



### 1:100 Scale

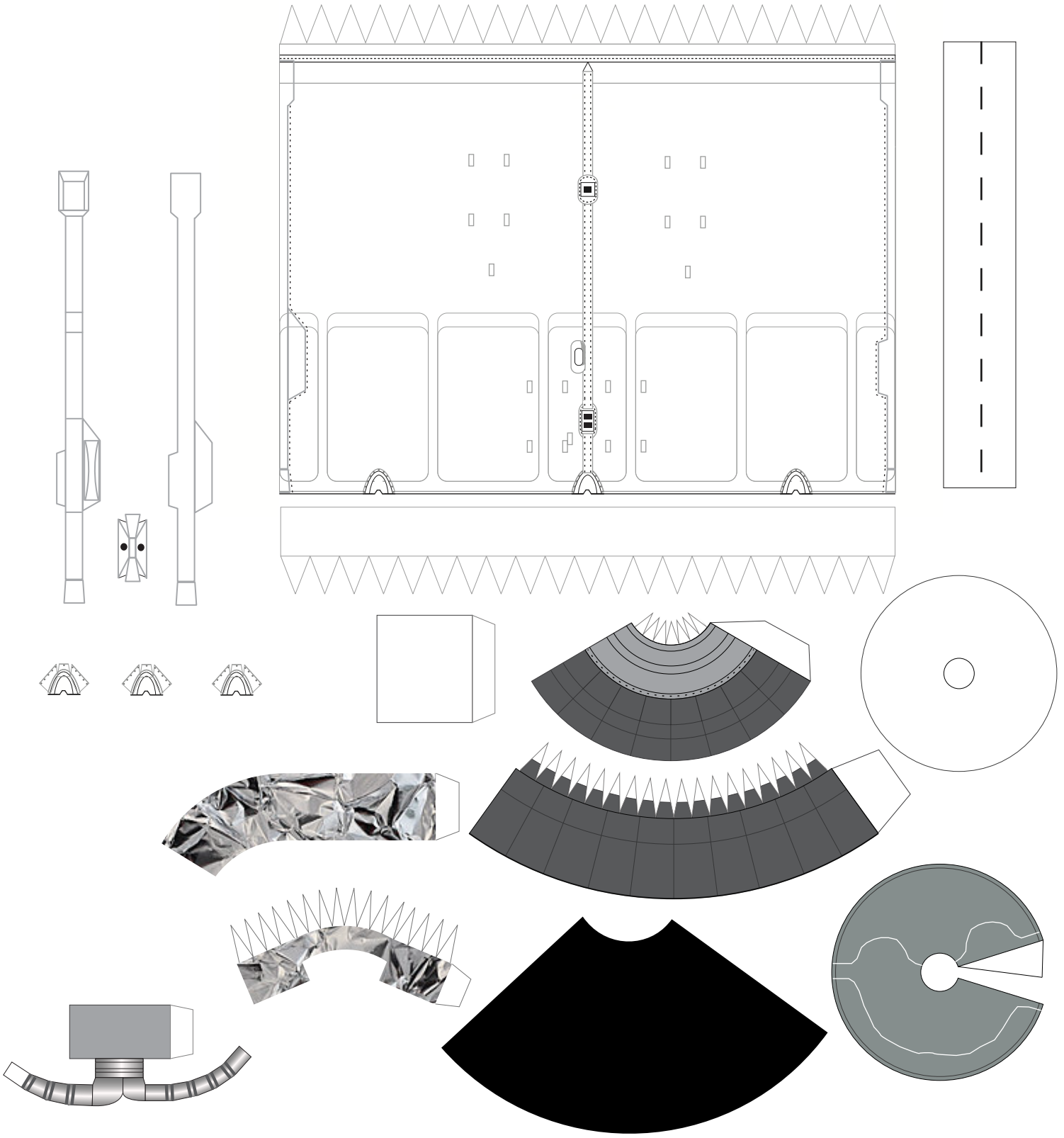



# SPACE-X "Falcon Heavy"

Print on Cardstock (110 lbs)

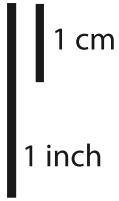

Separate Interstage

1:100 Scale

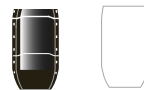
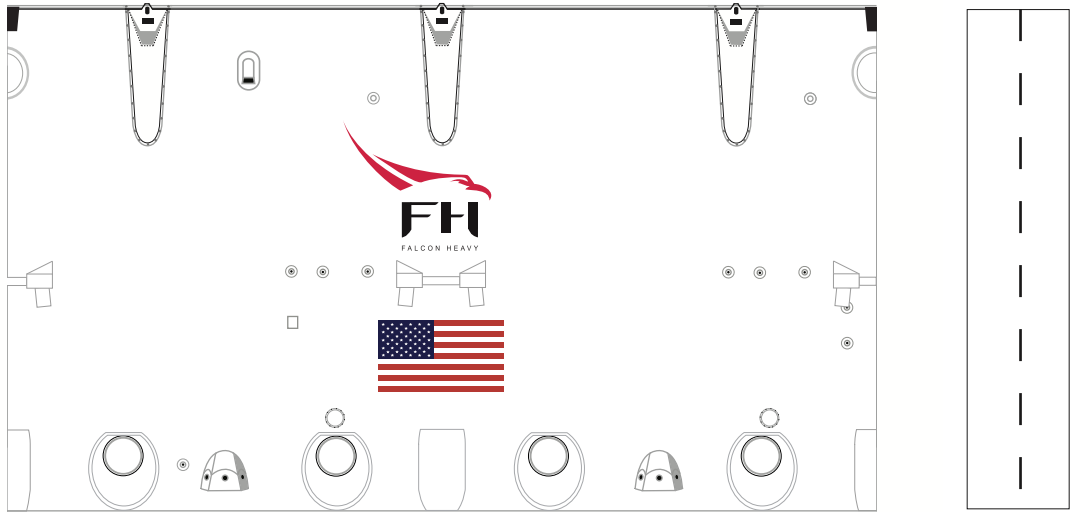
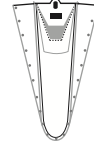
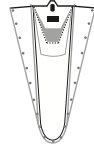
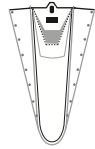

Titanium Grid Fins

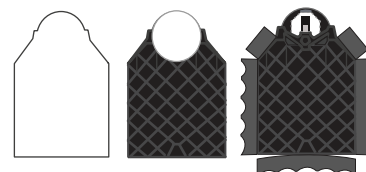
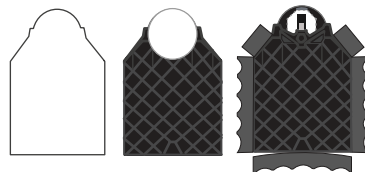
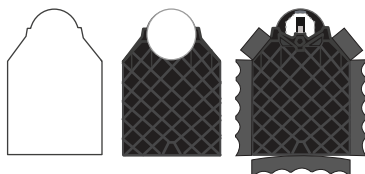



# SPACE-X "Falcon Heavy"

Print on Cardstock (110 lbs)

1 cm

Enlarged Second Stage / Interstage

Block 5 Second Stage  
Titanium Grid Fins

1 inch

1:100 Scale

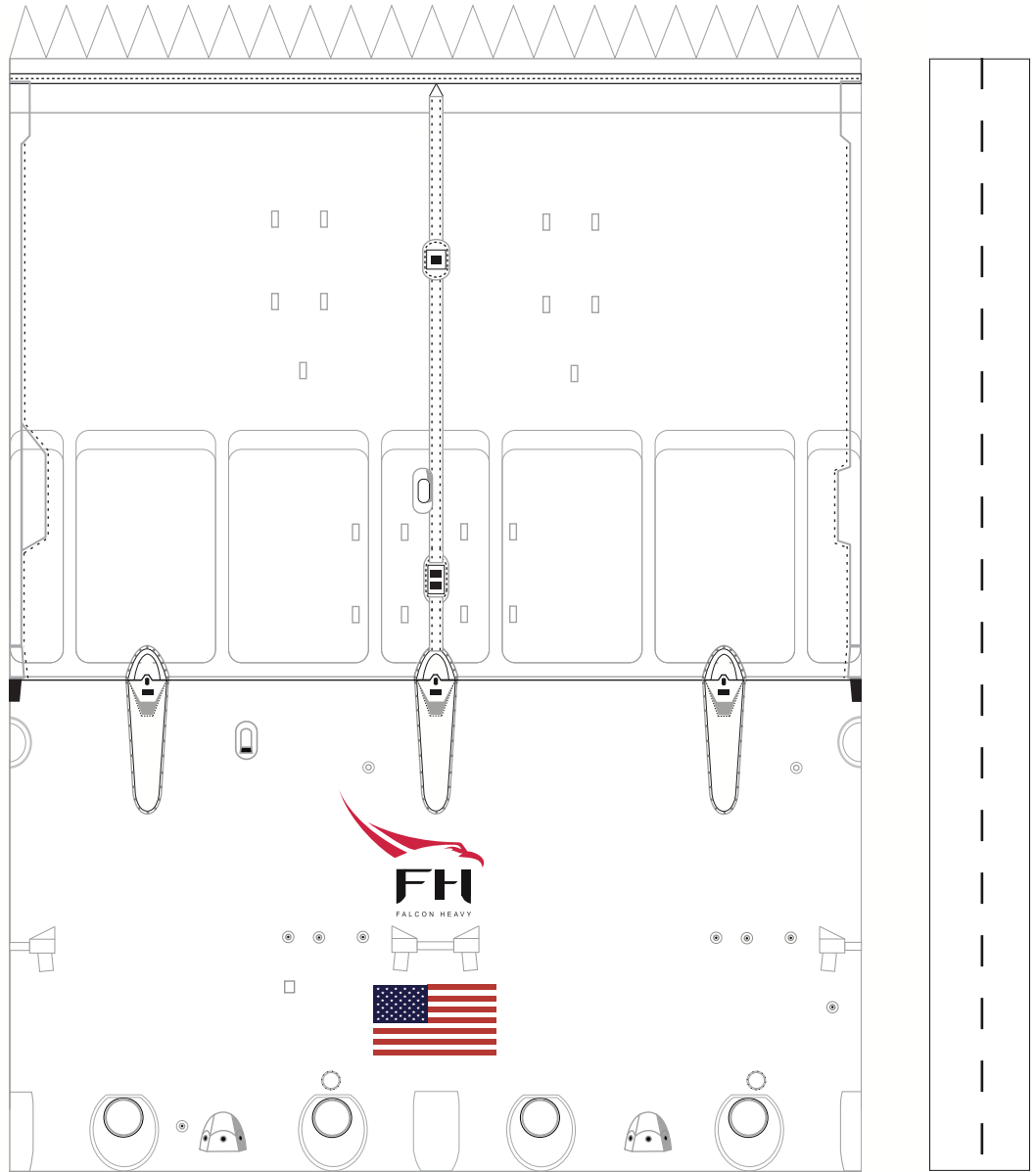
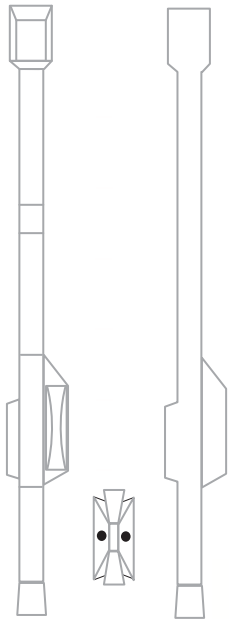

Titanium Grid Fins

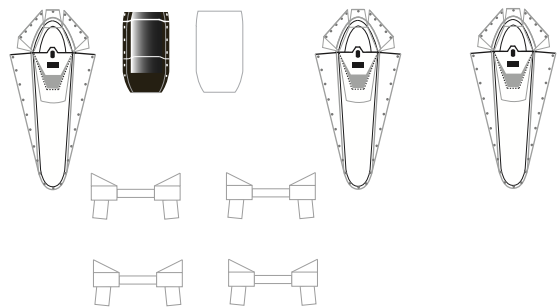
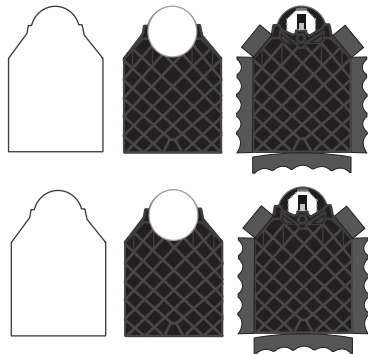
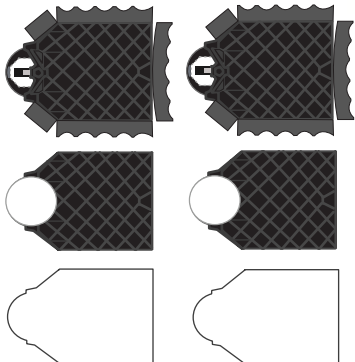



1:100 Scale



# SPACE-X "Falcon 9 Block 5" Center Core

Print on Cardstock (110 lbs)

Block 5

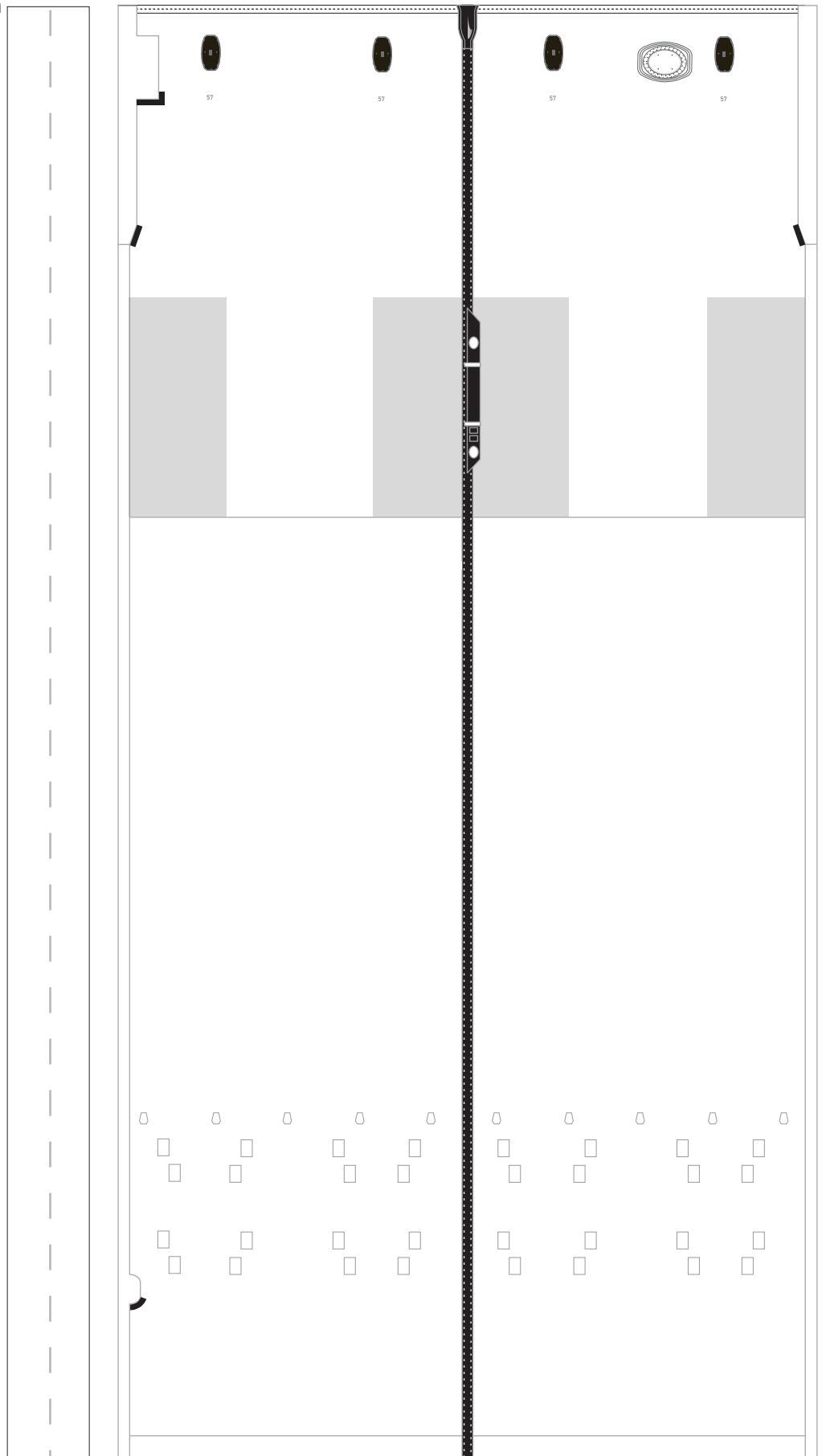
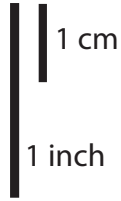



1:100 Scale



# SPACE-X "Falcon 9 Block 5"

Print on Cardstock (110 lbs)

Rev. 1  
Block 5



## Center Core

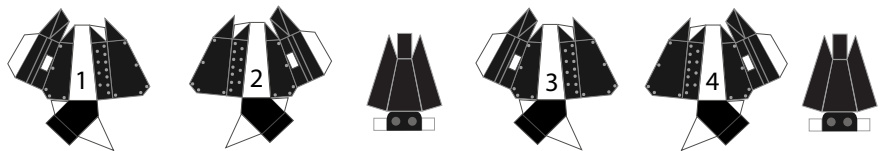
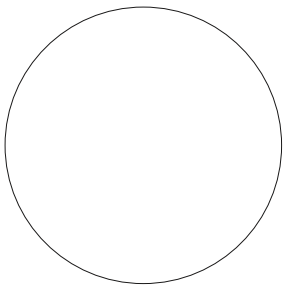
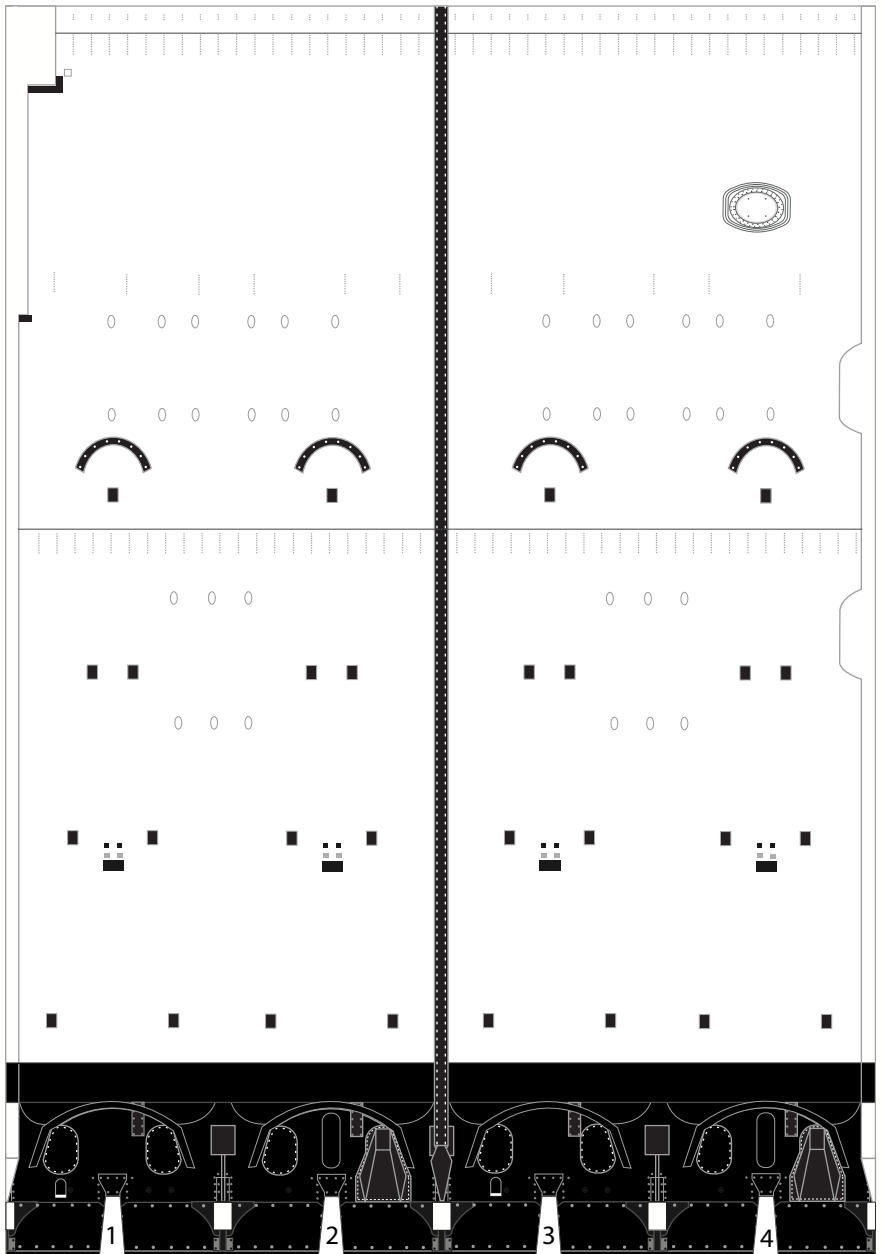
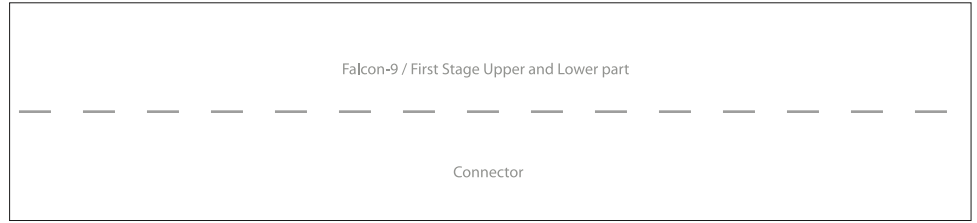



# SPACE-X "Falcon Heavy"

Print on Cardstock (110 lbs)



## Upper Attachments



1:100 Scale

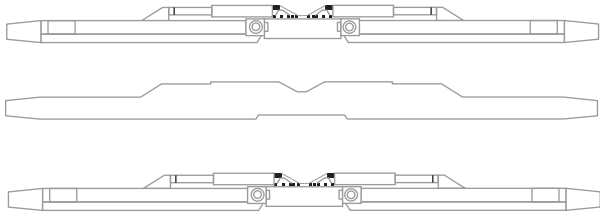
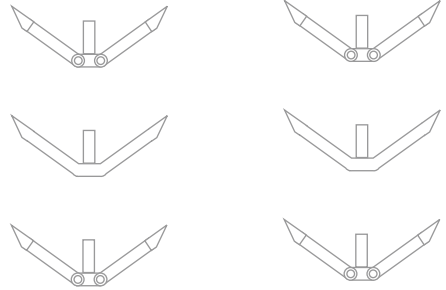
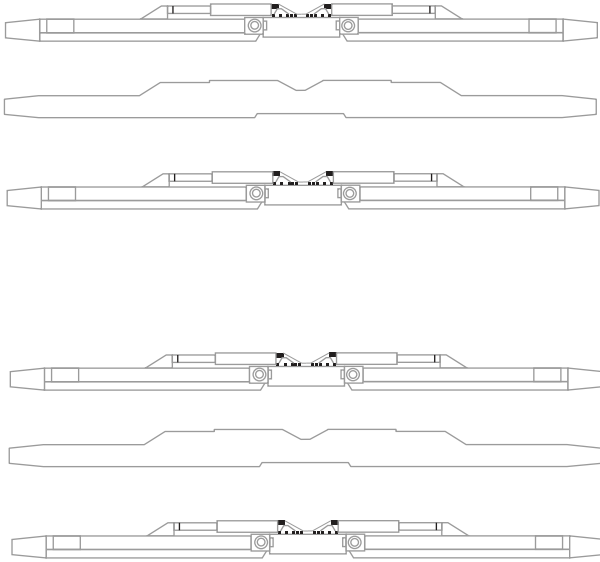

Spare parts

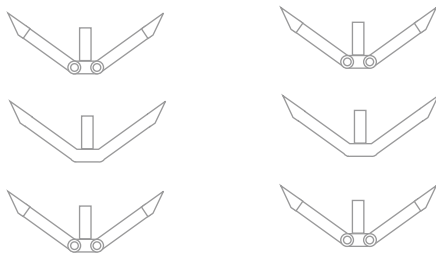
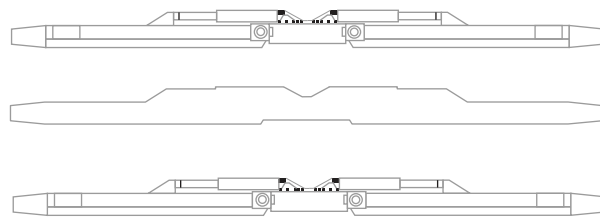

Fairing Connector 2.0

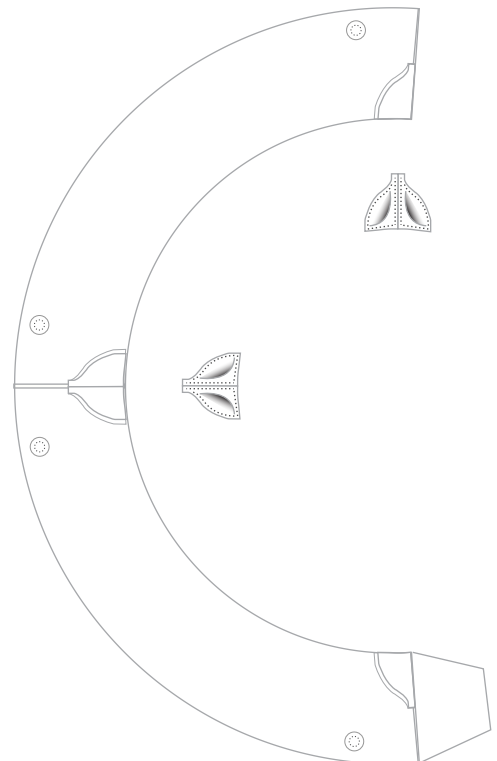



1:100 Scale

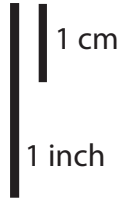

# SPACE-X "Falcon Heavy"

Print on Cardstock (110 lbs)

## Block 5 Side booster Nosecone RIGHT

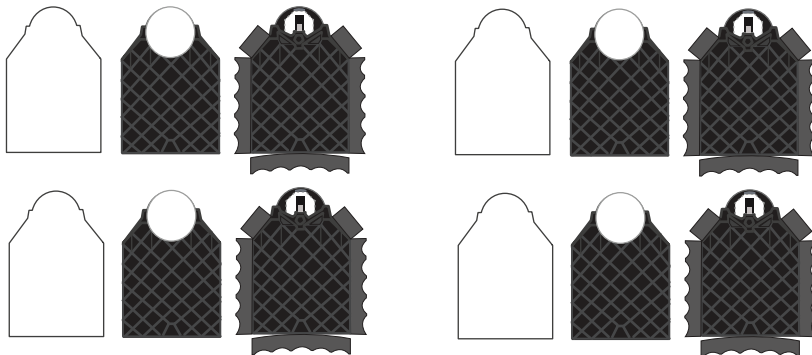
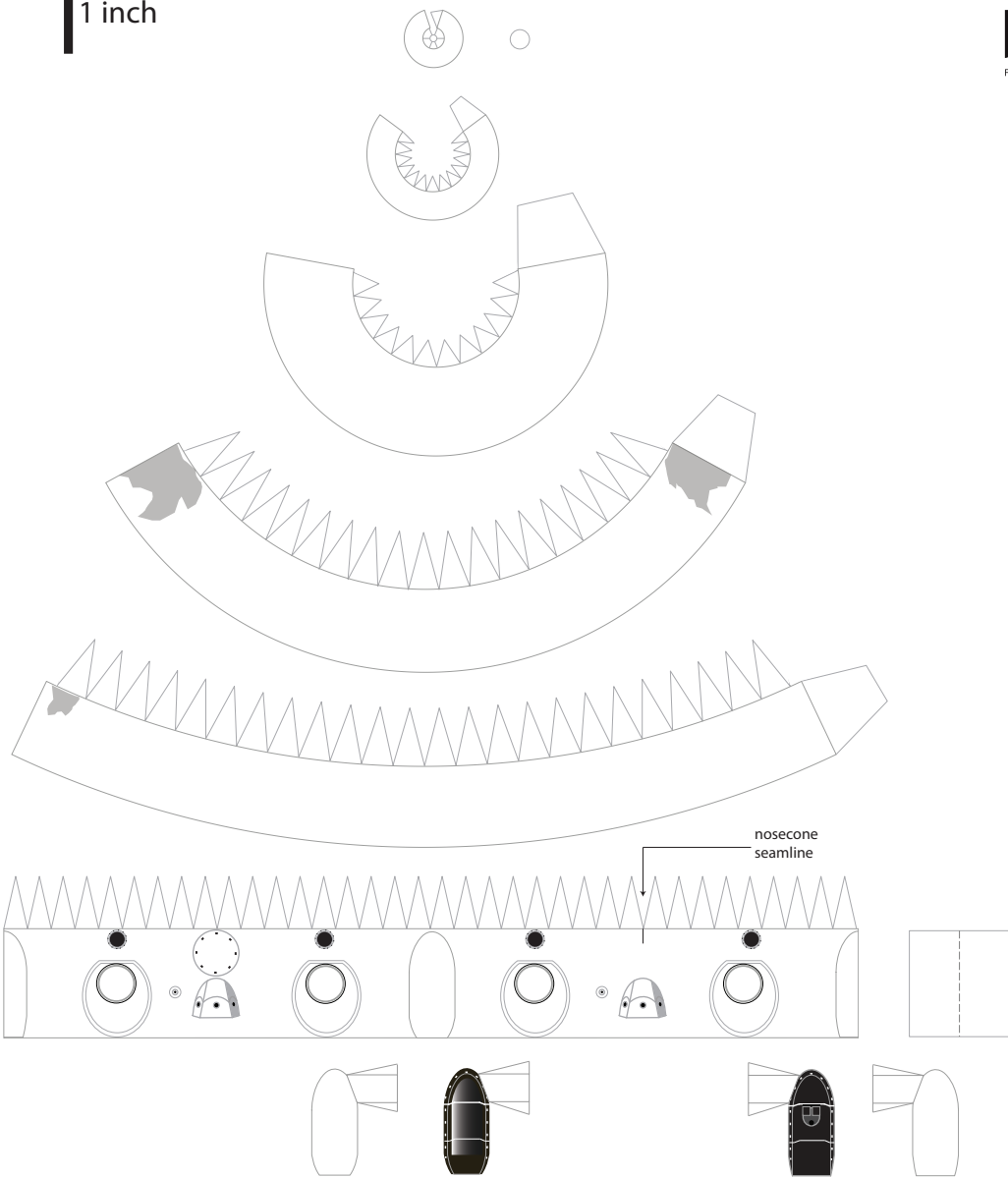





1:100 Scale



# SPACE-X "Falcon Heavy"

Print on Cardstock (110 lbs)

## Block 5 Side booster Nosecone

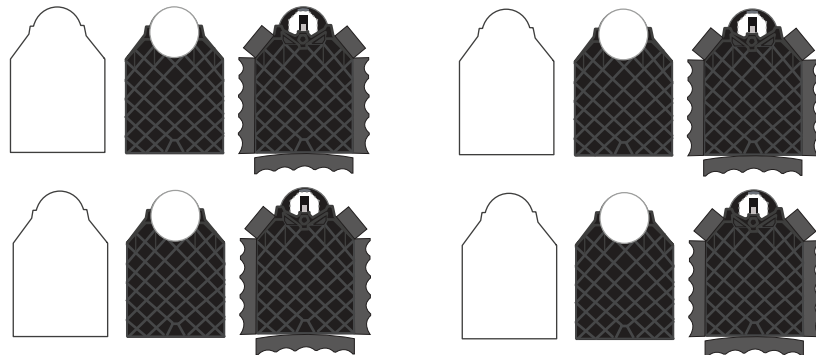
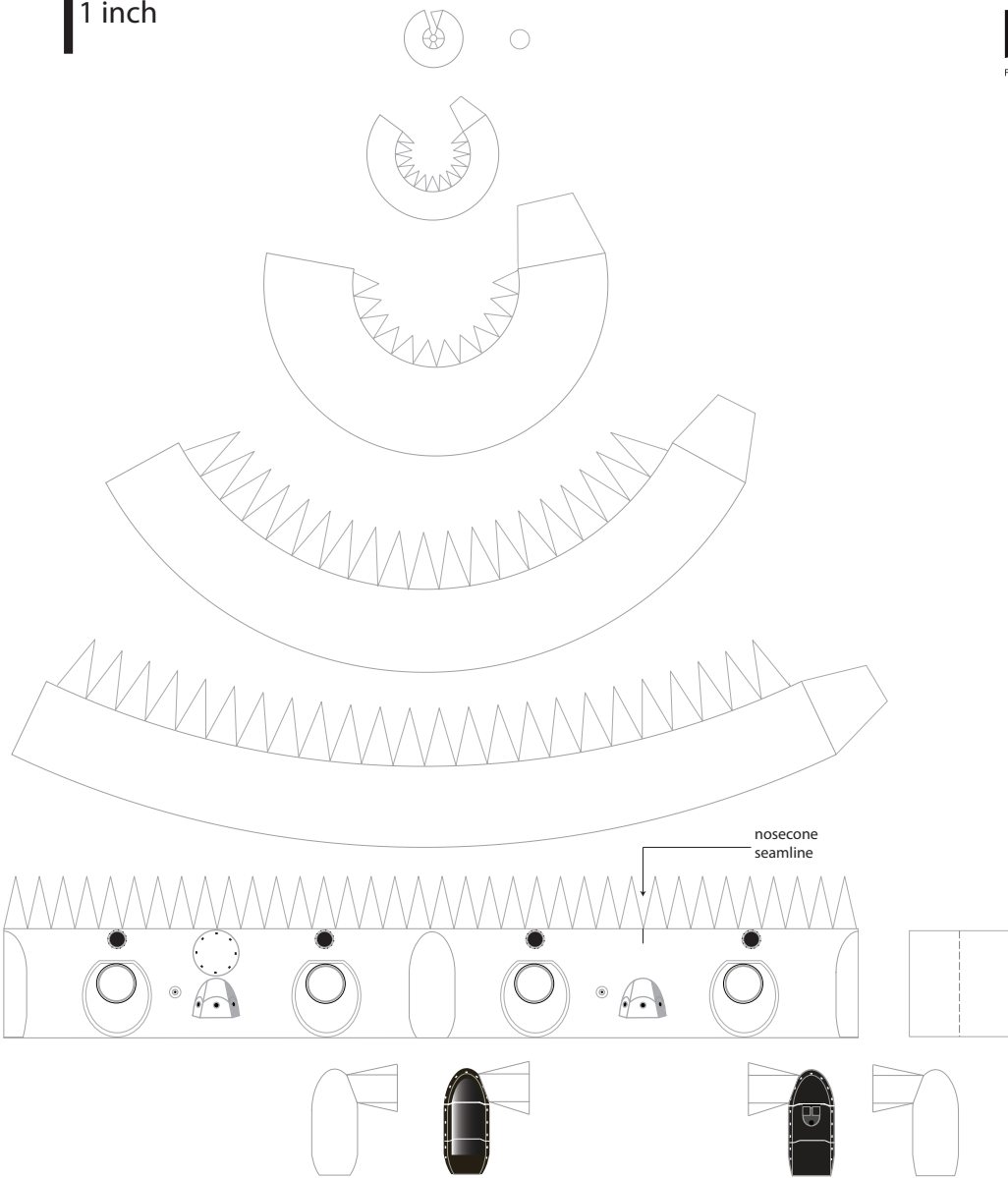



1:100 Scale



# SPACE-X "Falcon 9 Block 5" Left booster

Print on Cardstock (110 lbs)

Block 5





1:100 Scale



FALCON  
9

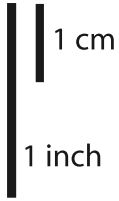
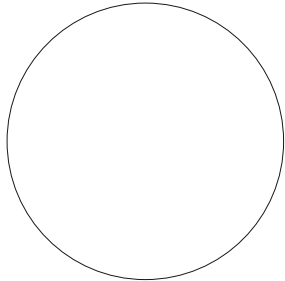
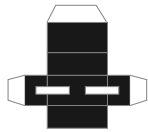
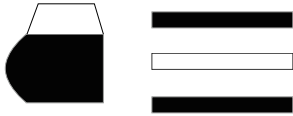
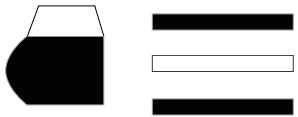

# SPACE-X "Falcon 9 Block 5"

Print on Cardstock (110 lbs)

## Left Side Booster

Rev. 1  
Block 5

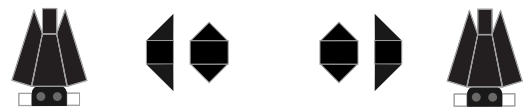
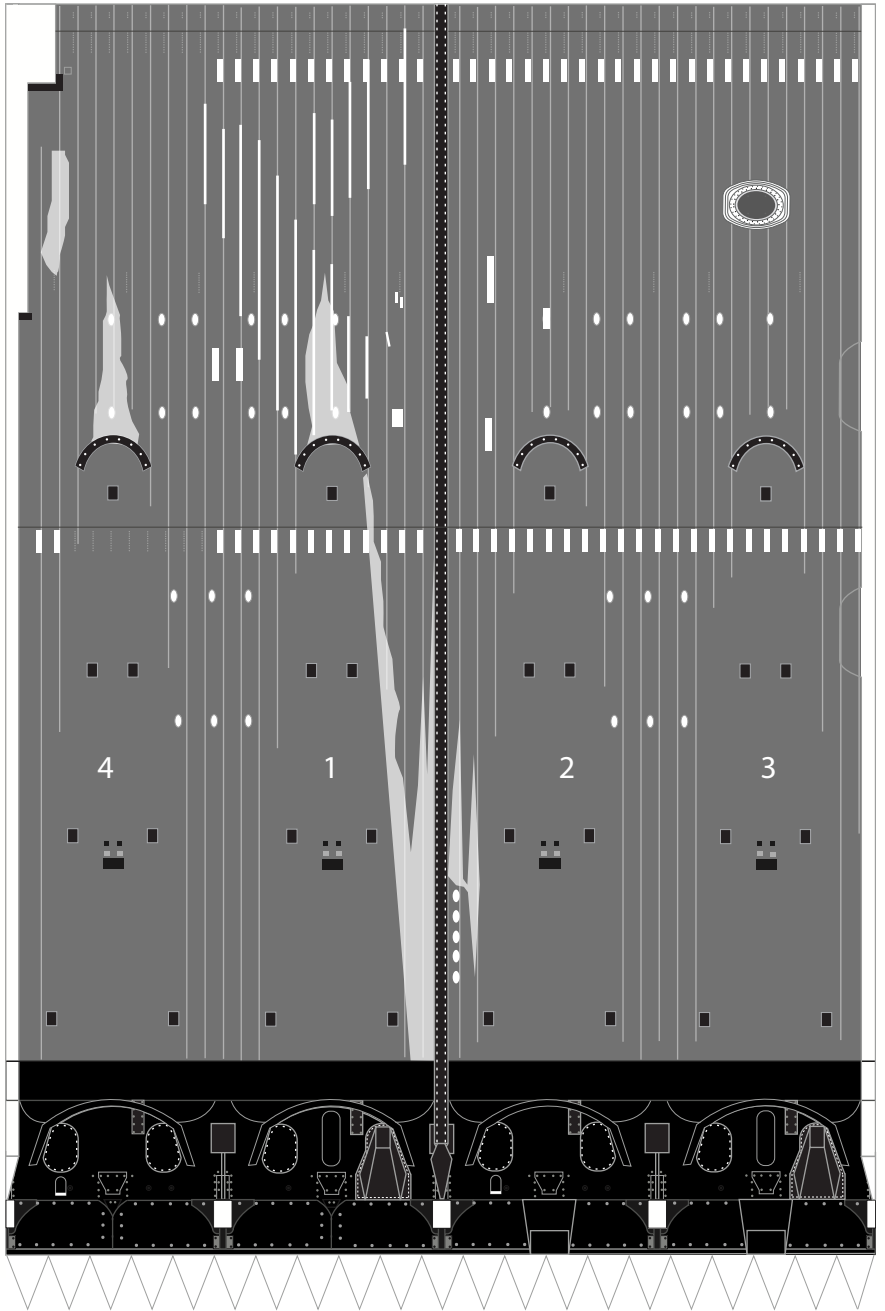
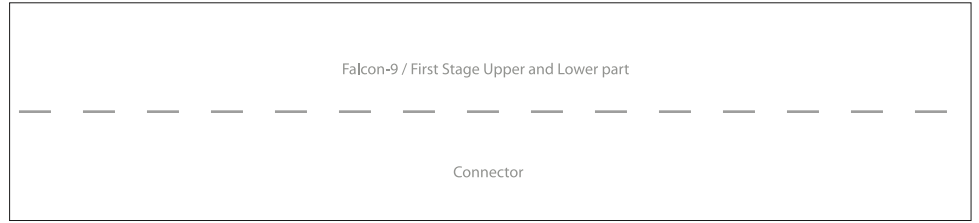



1:100 Scale



# SPACE-X "Falcon 9 Block 5" Right booster

Print on Cardstock (110 lbs)

Block 5

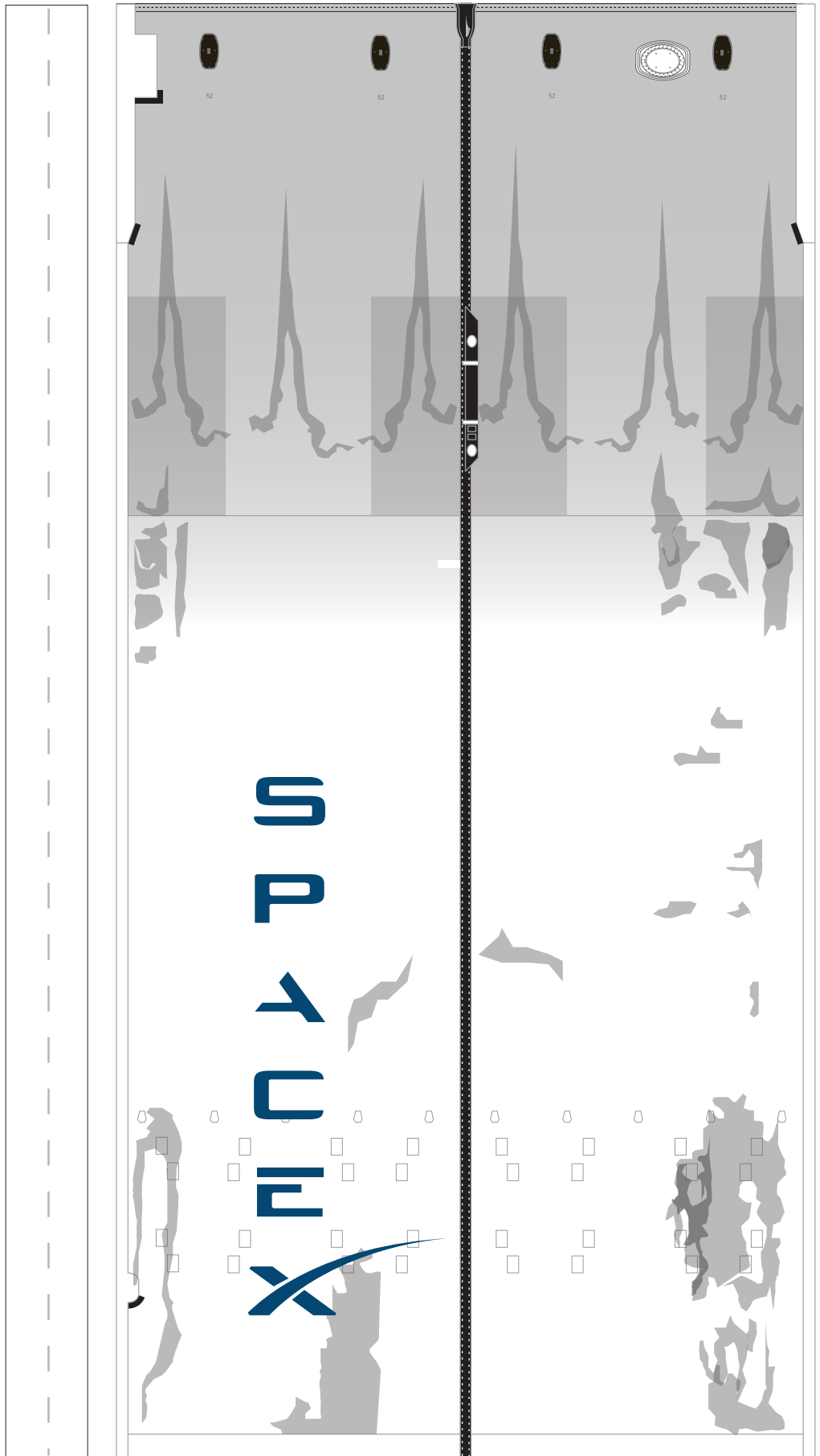



1:100 Scale



FALCON  
9

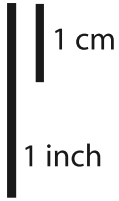
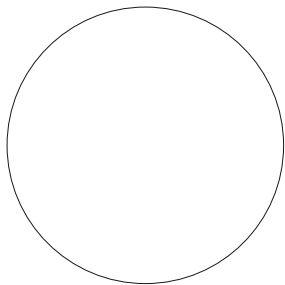
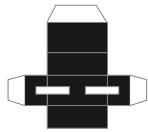
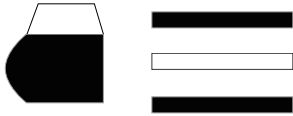
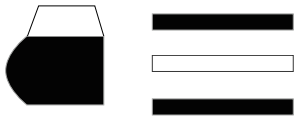

# SPACE-X "Falcon 9 Block 5"

Print on Cardstock (110 lbs)

## Right Side Booster

Rev. 1  
Block 5

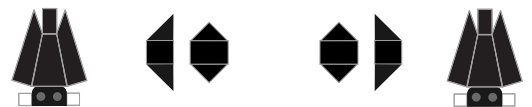
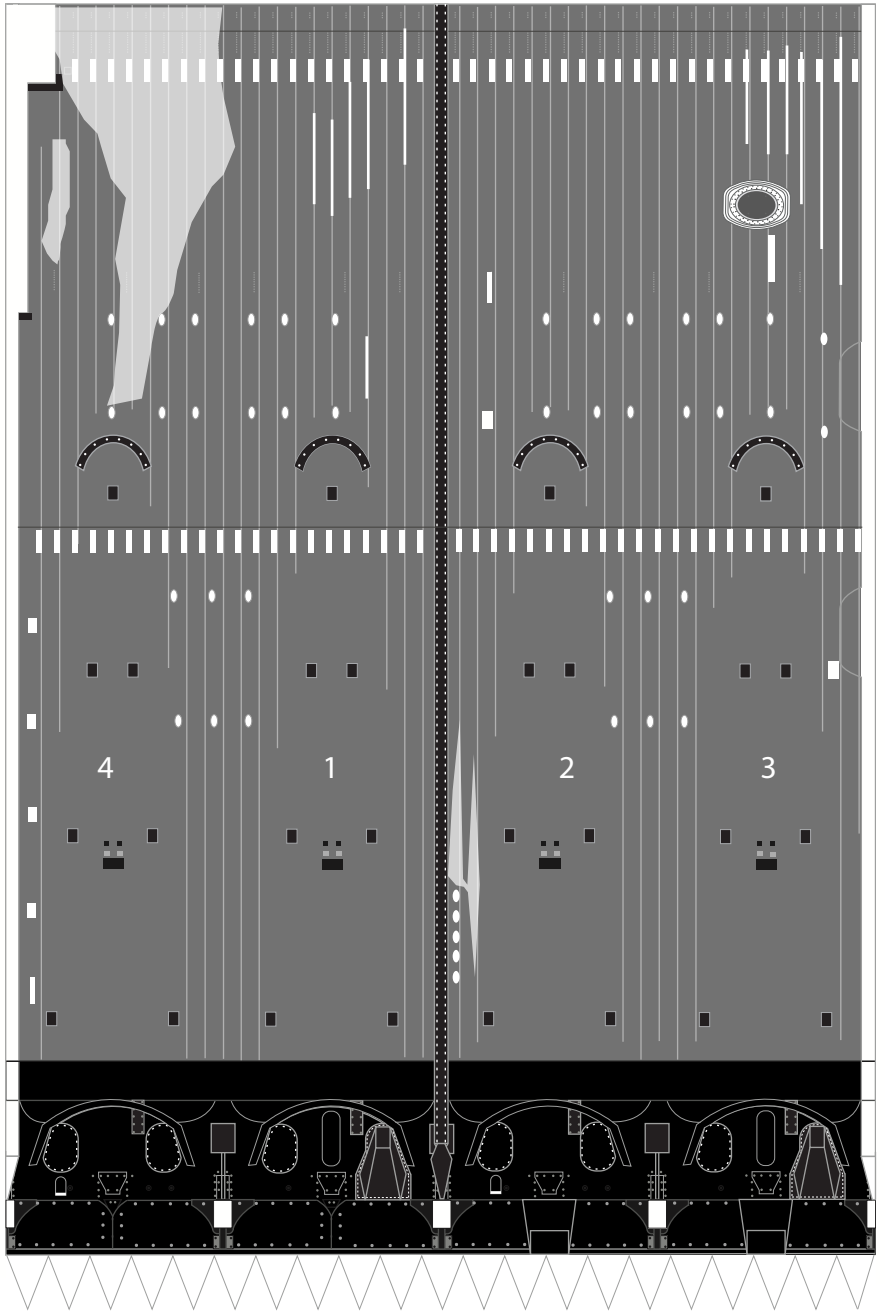
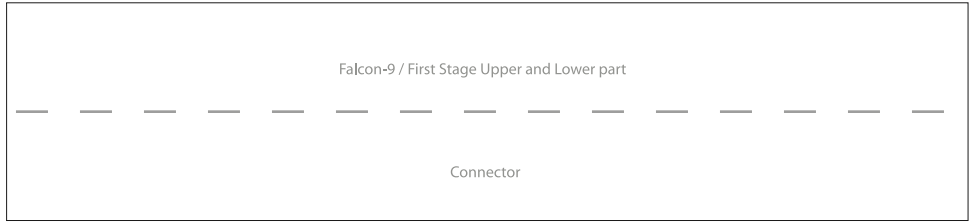



1:100 Scale



# SPACE-X "Falcon 9 Block 5"

Print on Cardstock (110 lbs)

BLOCK 5



PRINT X 3

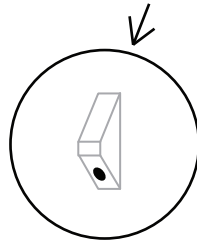

Thicker Raceway





1:100 Scale

# SPACE-X "Falcon 9 Block 5"

Print on Cardstock (110 lbs)

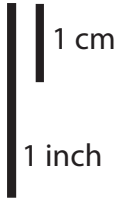

## LEGS 2.0

Center Core Only

Rev. 1

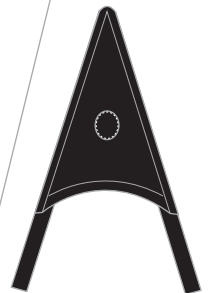
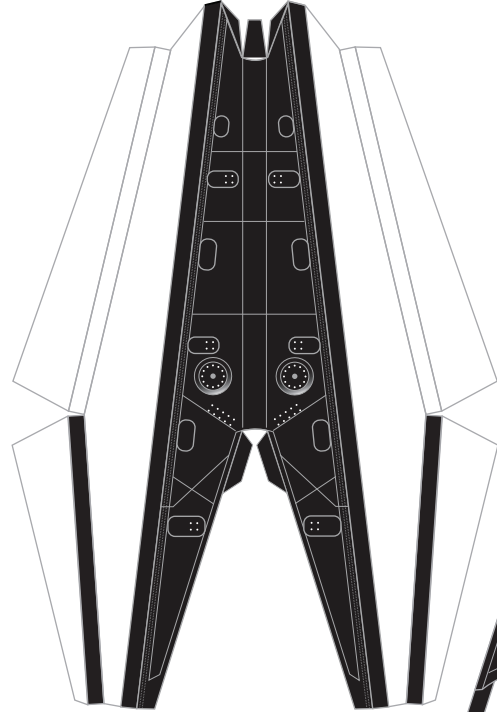
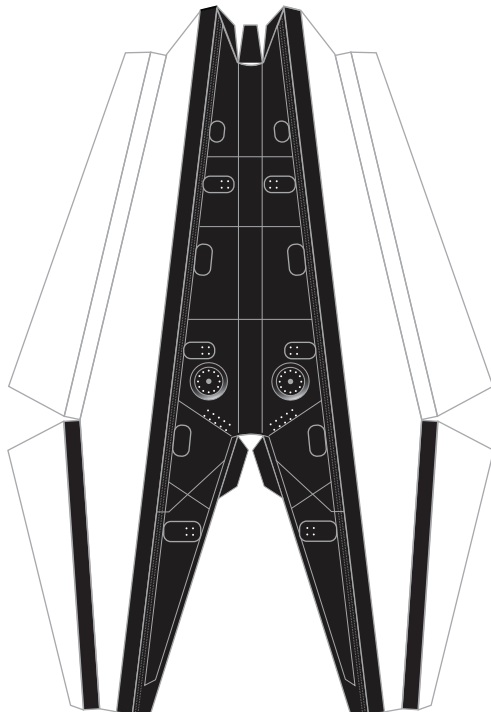
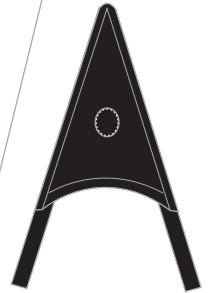
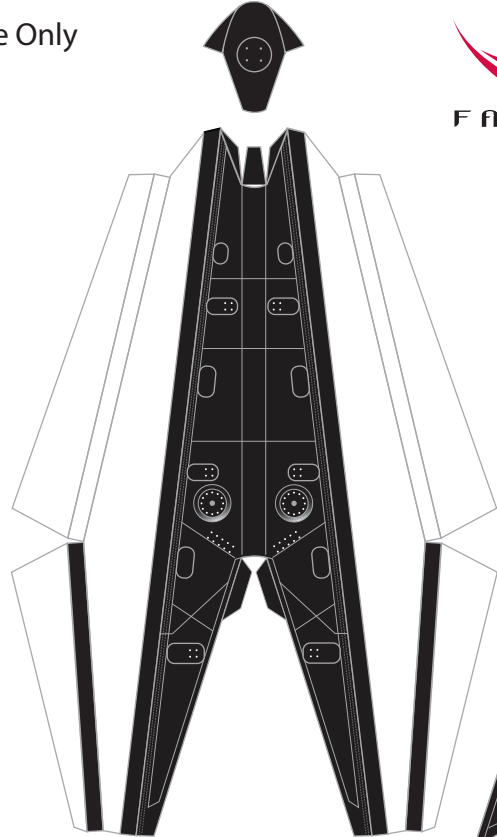
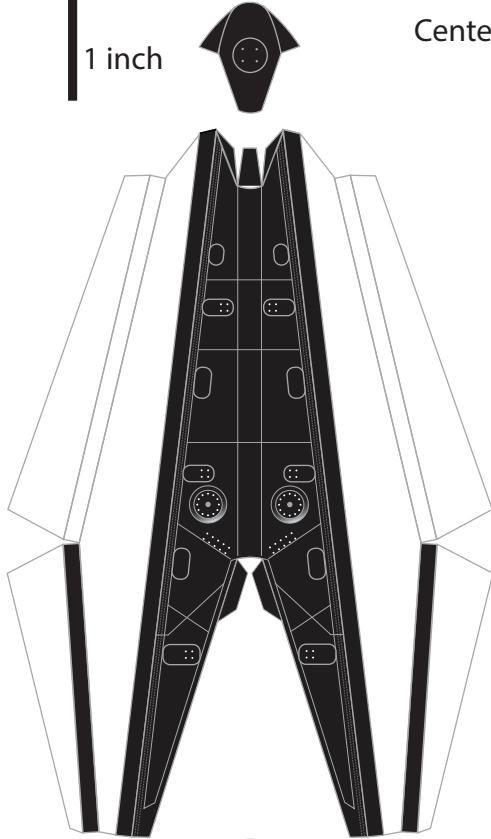
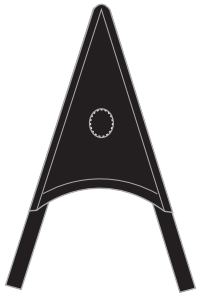



# SPACE-X "Falcon-9 Block 5"

Print on Cardstock (110 lbs)

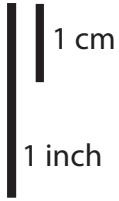

## LEGS 2.0

PRINT X 2

Side Boosters only



1:100 Scale

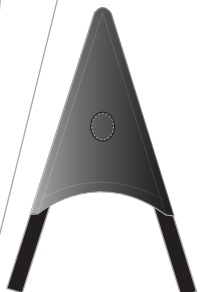
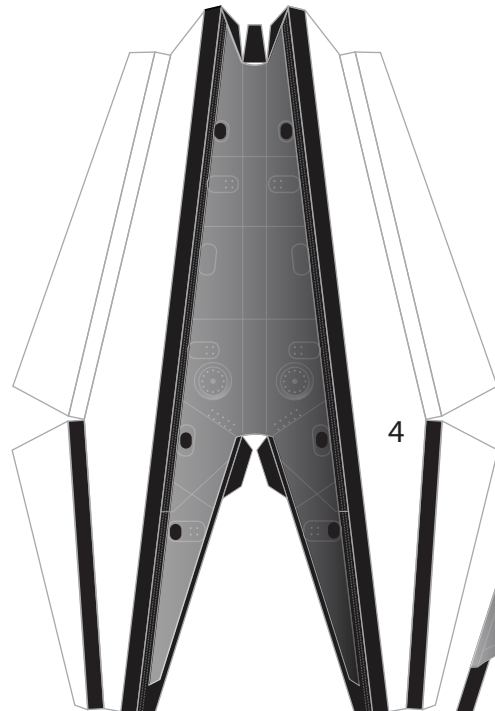
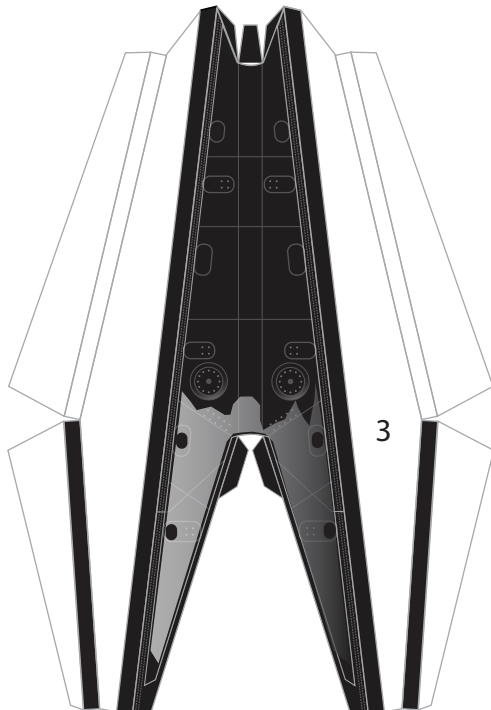
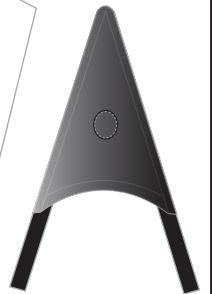
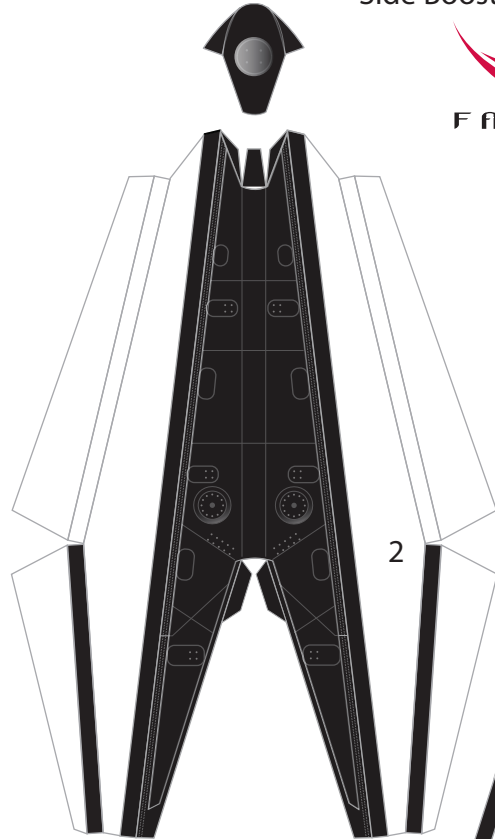
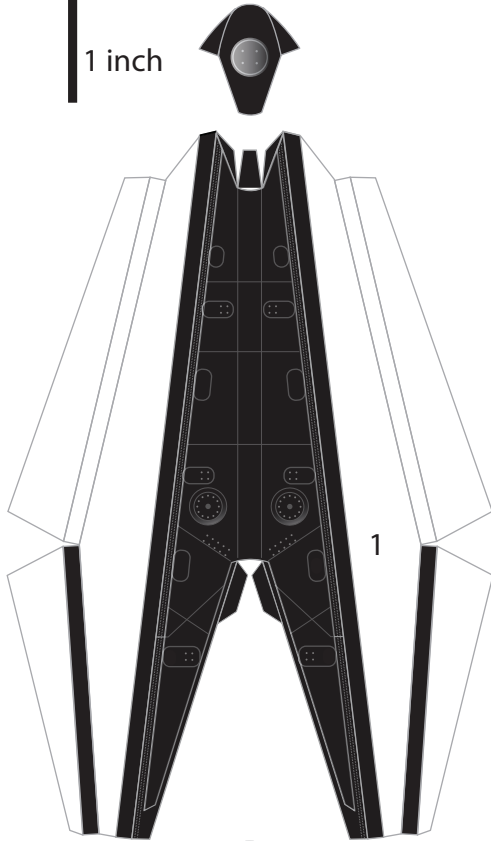





# SPACE-X "Falcon 9 Block 5"

Print on Cardstock (110 lbs)

Rev. 2

LEGS 2.0 page 2

PRINT X 3



1:100 Scale

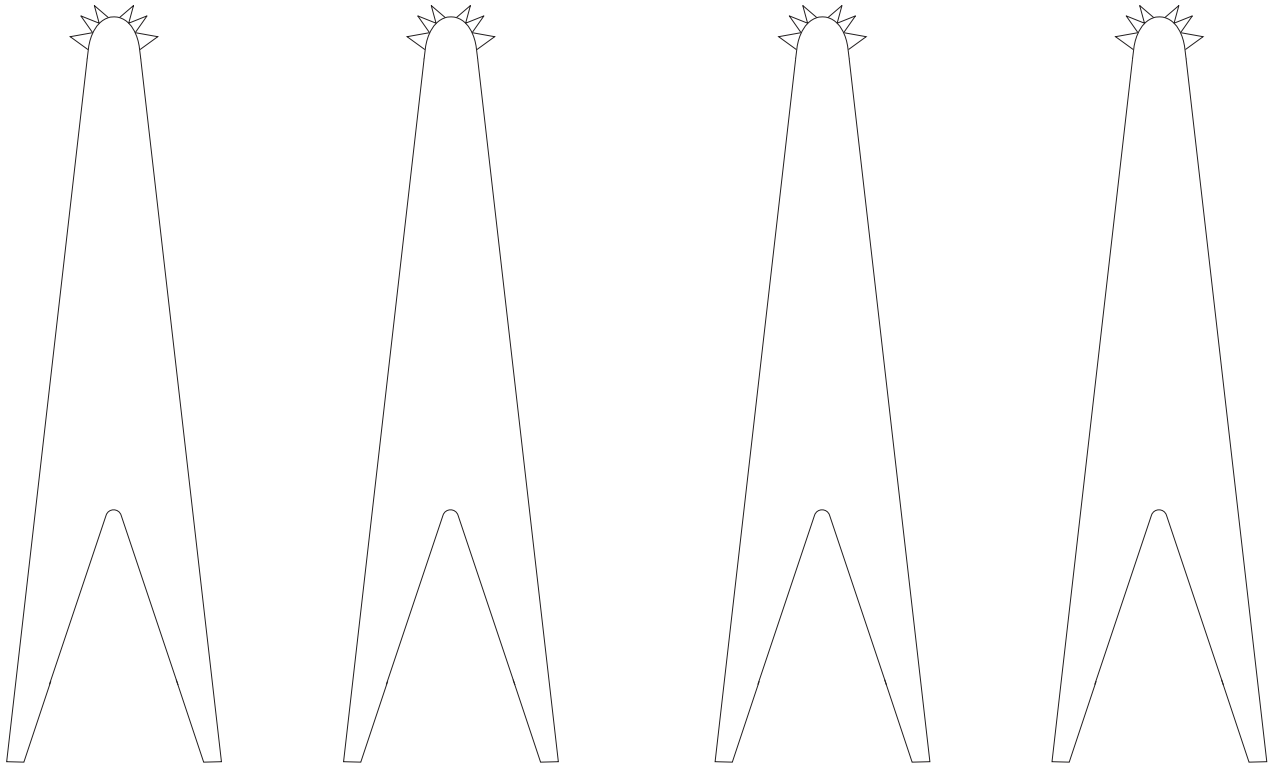

Legs pins

(roll the complete strip and then cut the individual pieces)

## New Leg Hinges

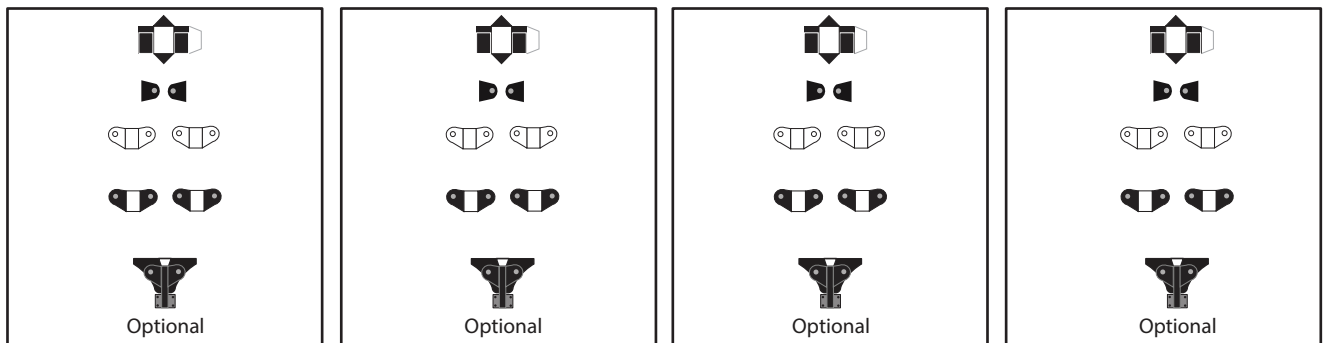



1:100 Scale

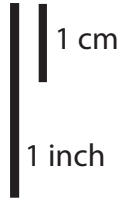

# SPACE-X "Falcon Heavy"

## MERLIN Engines

PRINT X 3

Print on Cardstock (110 lbs)

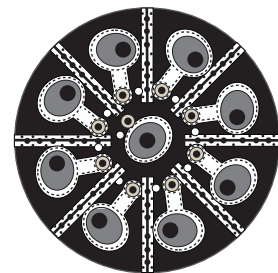
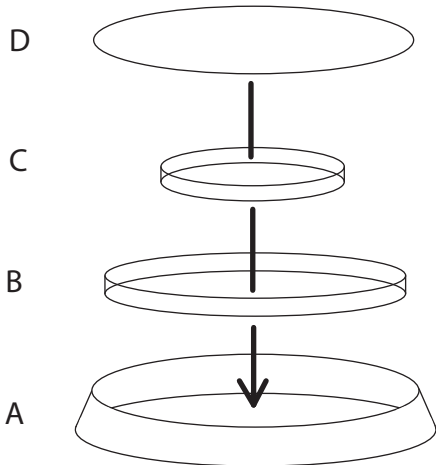
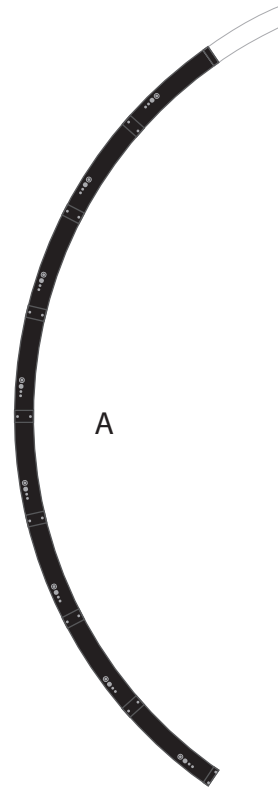
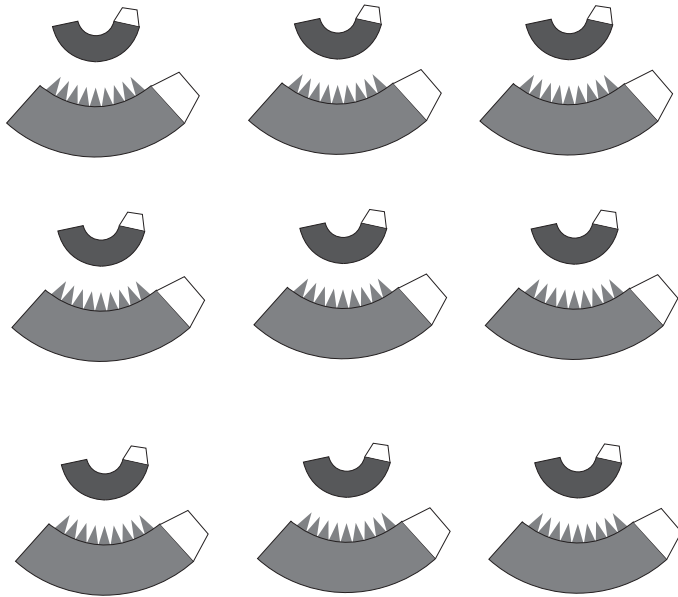

Engine Grid  
OCTAWEB



1:100 Scale



SPACE-X "Falcon 9 Block 5"

Print on Cardstock (110 lbs)

MERLIN Engines

BACK PRINT

