



1 cm  
1 inch

# GSLV MK-III M1

Print on Cardstock ( 110 lb )

## Chandrayaan 2

1:96 Scale

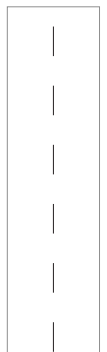
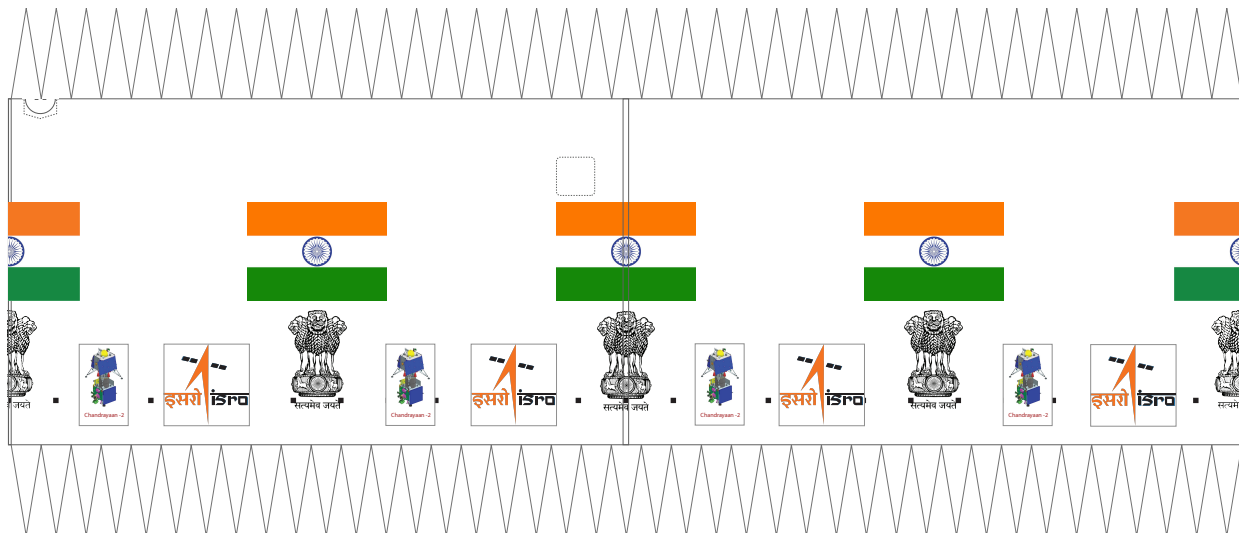
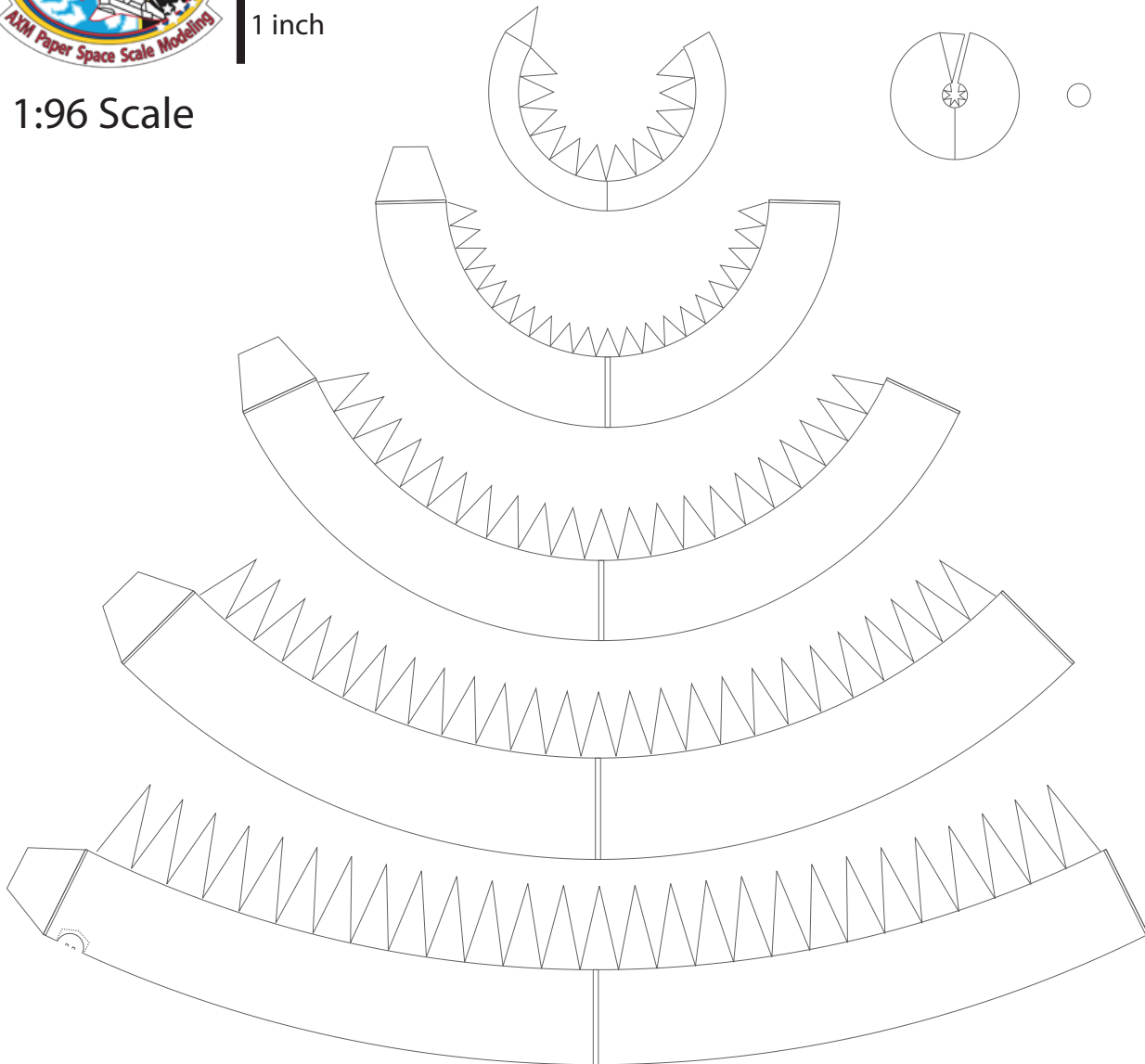



1 cm  
1 inch

# GSLV MK-III

## C 25 Cryogenic Upper Stage

Print on Cardstock ( 110 lb )

1:96 Scale

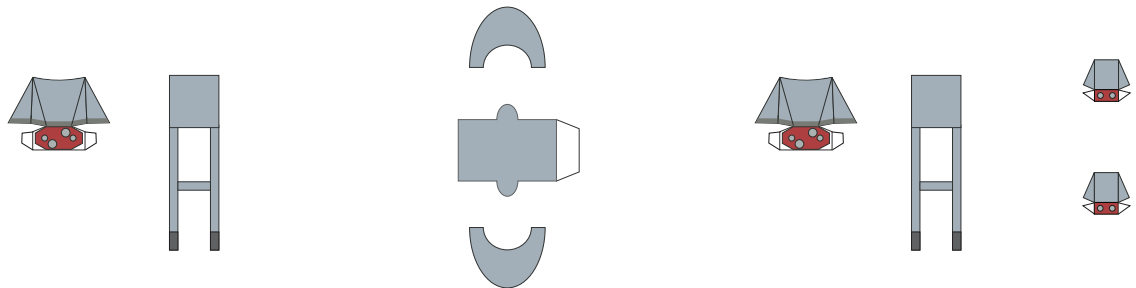
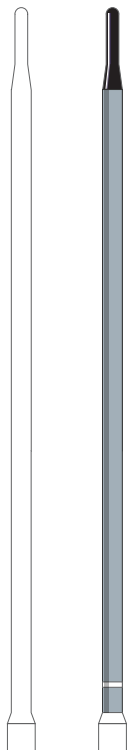
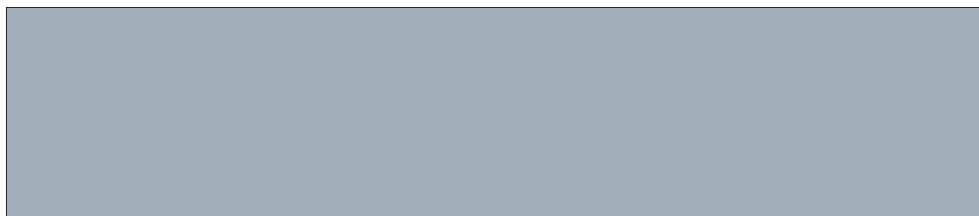
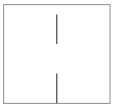
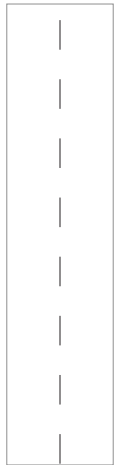
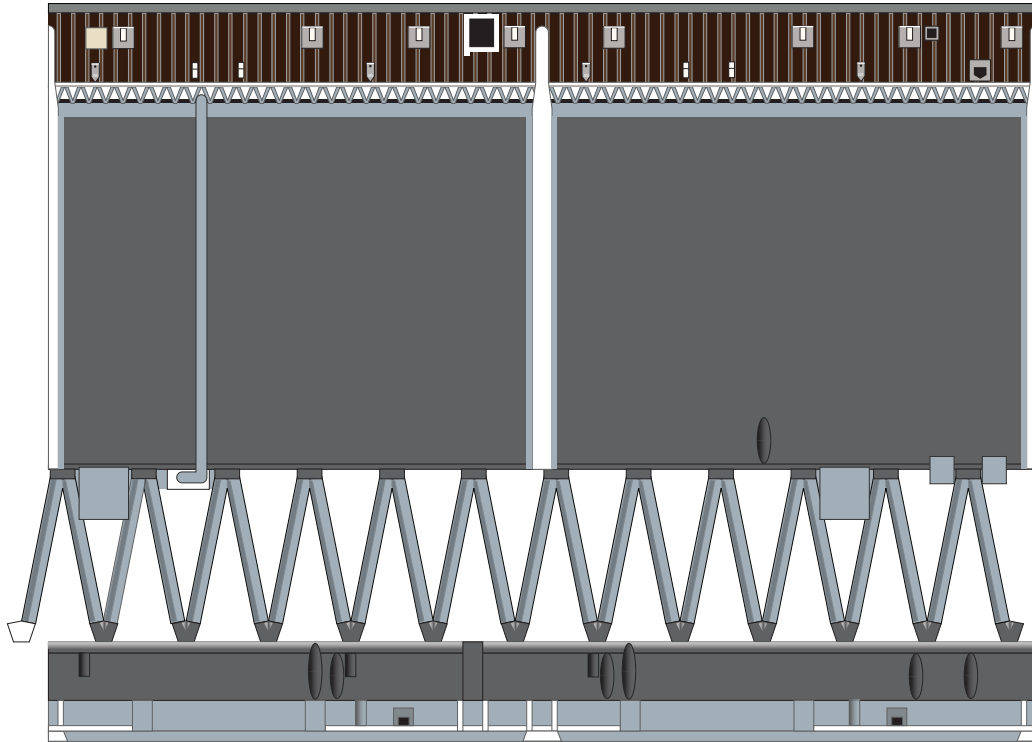
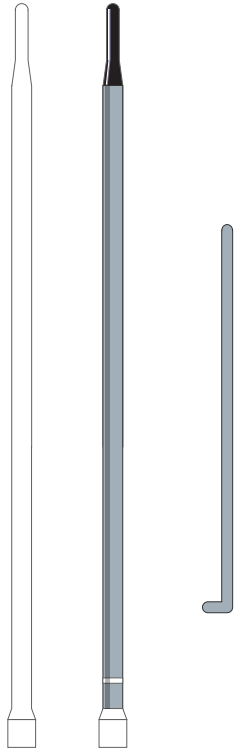



1 cm  
1 inch

# GSLV MK-III M1

Print on Cardstock ( 110 lb )

Launch pad configuration (use protective covers)



1:96 Scale

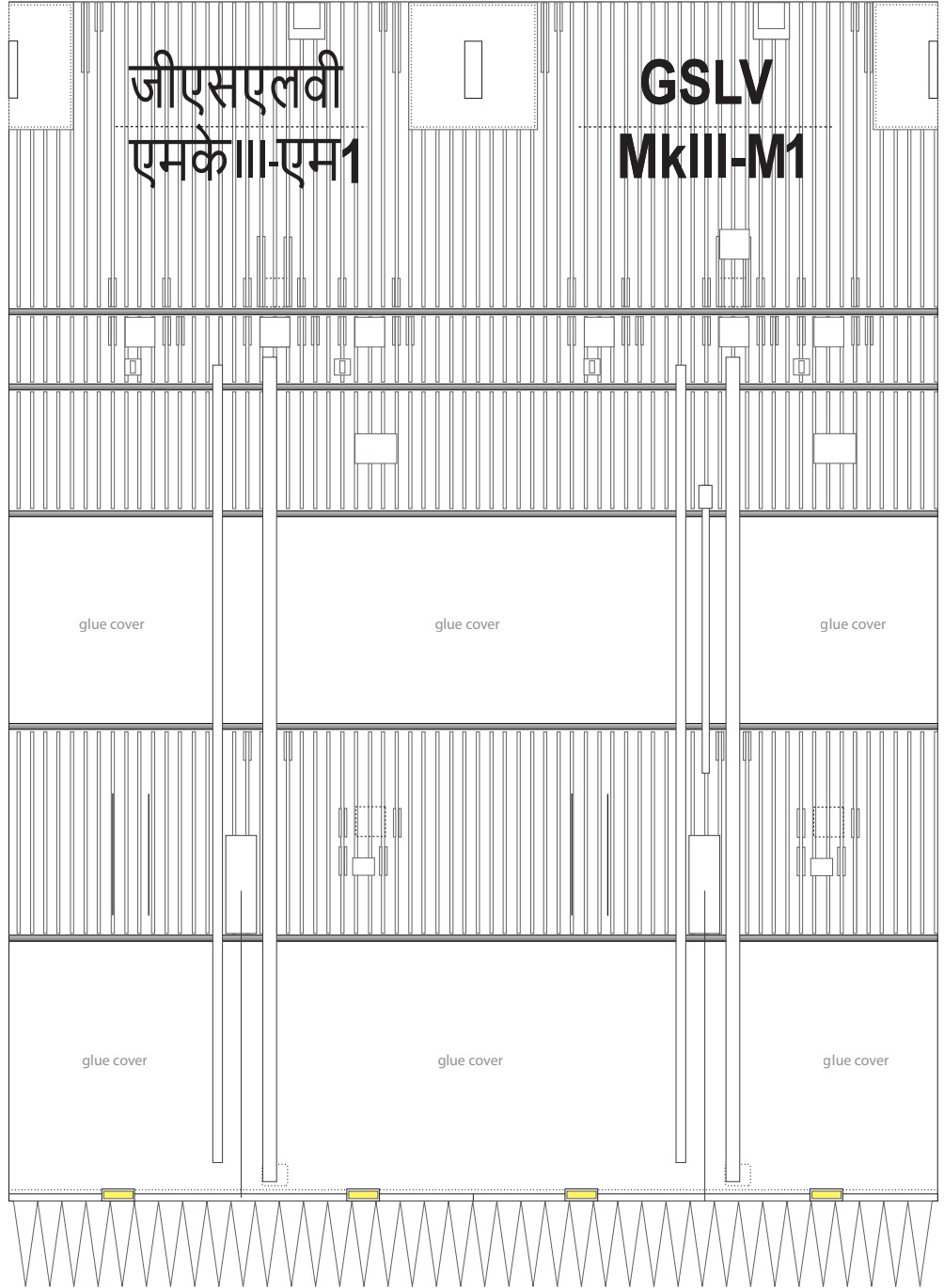
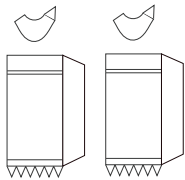
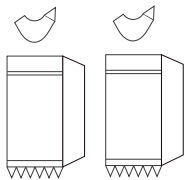
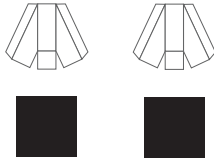
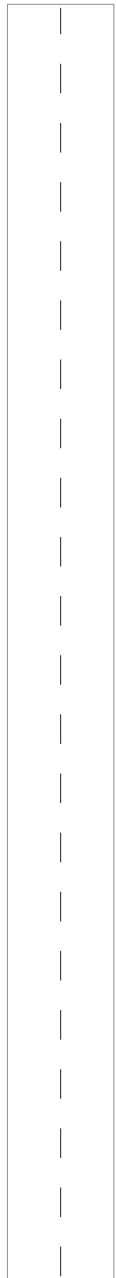

cut out  
yellow rectangles





# Umbilicals and Covers

Print on Cardstock ( 110 lb )

## GSLV MkIII

1:96 Scale

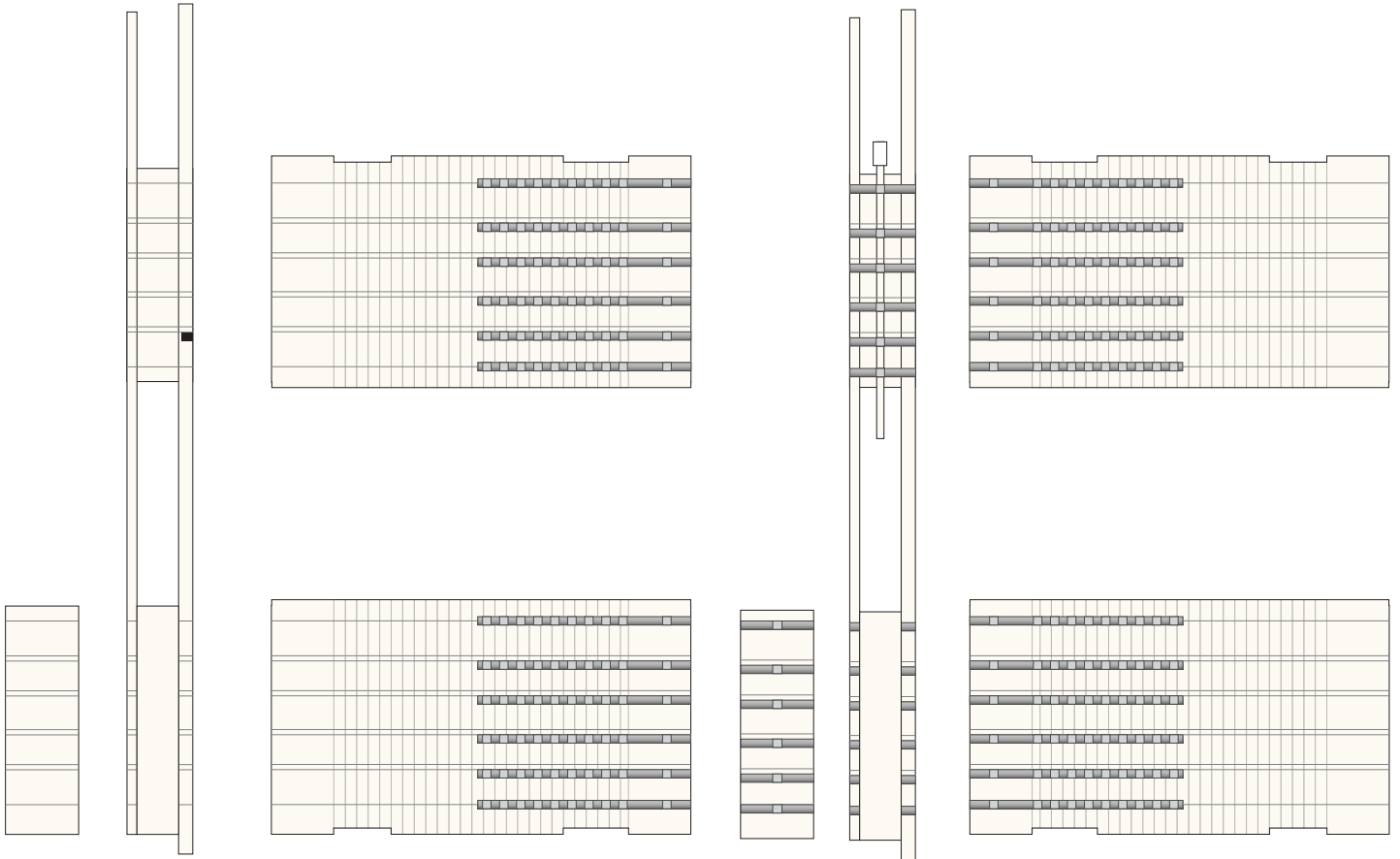



1:96 Scale

# PRINT ON PLAIN PAPER GSLV MkIII

Use cottonswabs 47 mm in length  
with an aprox. 2.5 mm in width

(Use these skins to cover the swabs)

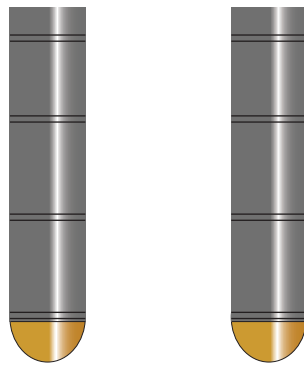



1 cm

1 inch

# Engine section

Print on Cardstock ( 110 lb )

1:96 Scale

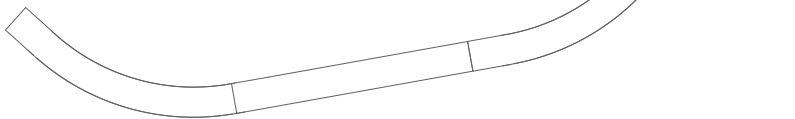
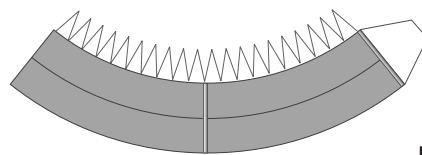
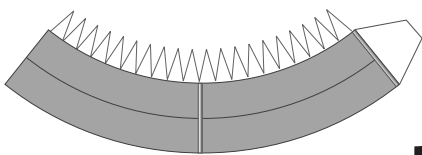
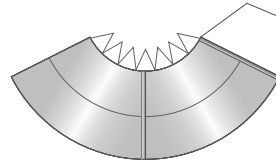
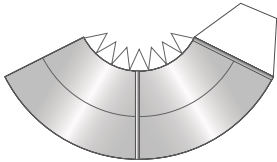
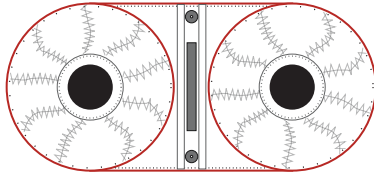
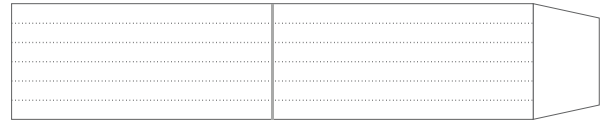
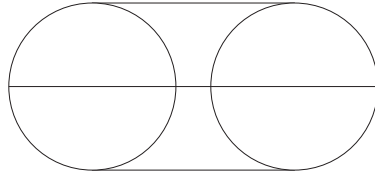
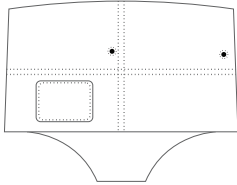
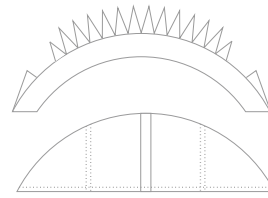
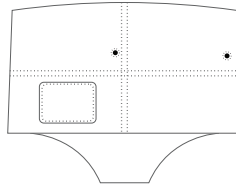
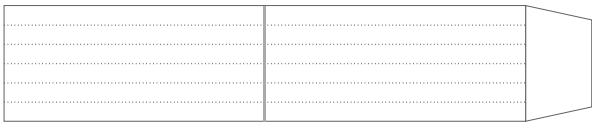
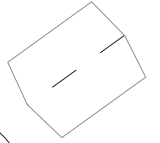
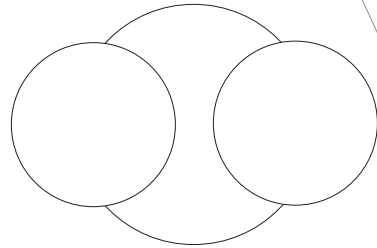
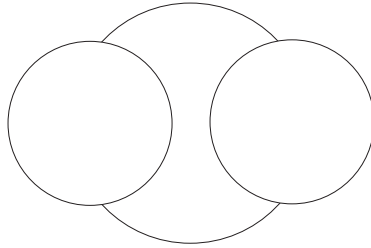
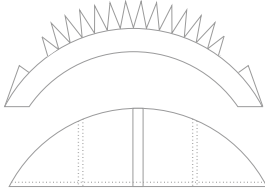
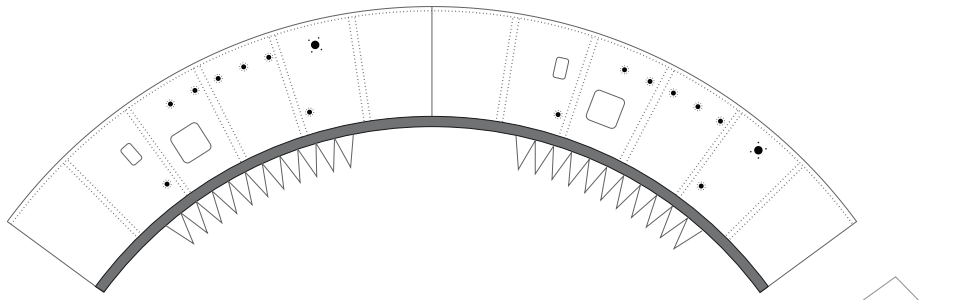



1 cm

1 inch

# GSLV MK-III M1

Print on Cardstock ( 110 lb )

1:96 Scale

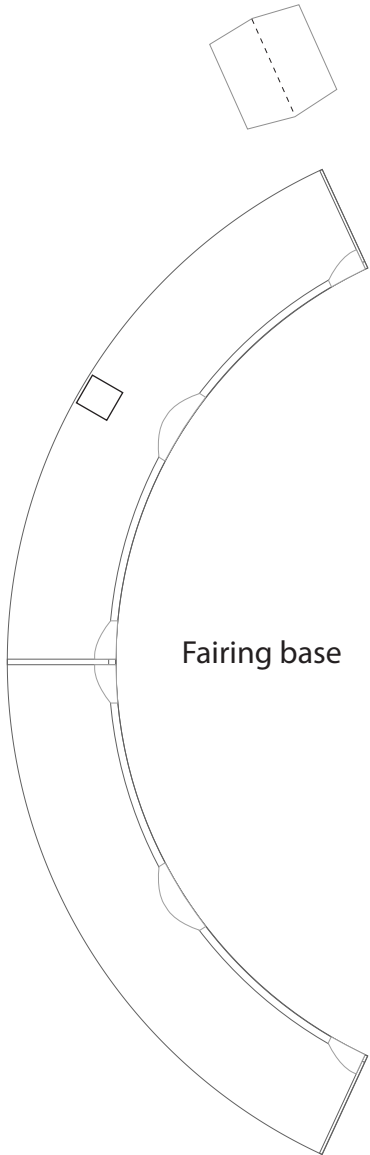

Fairing base

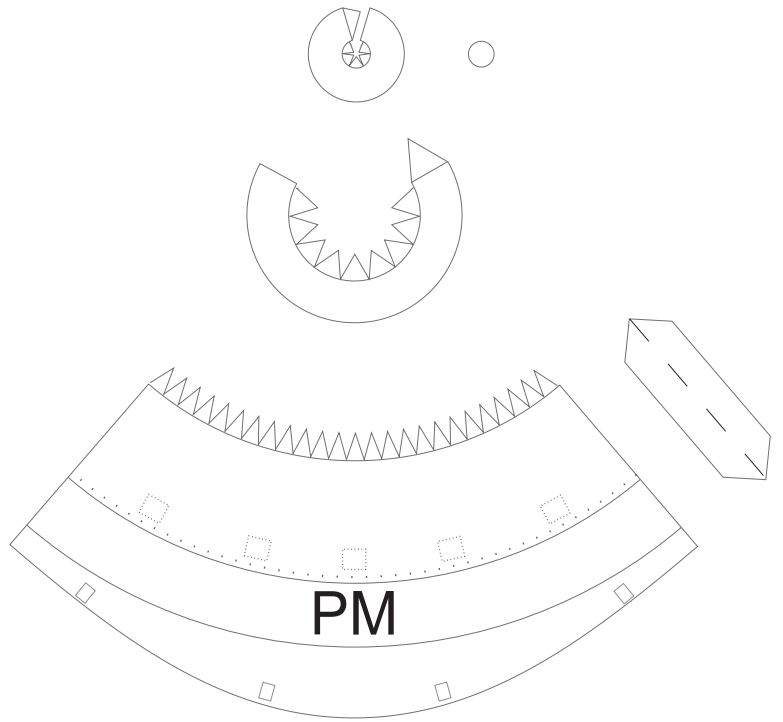

PM

Left

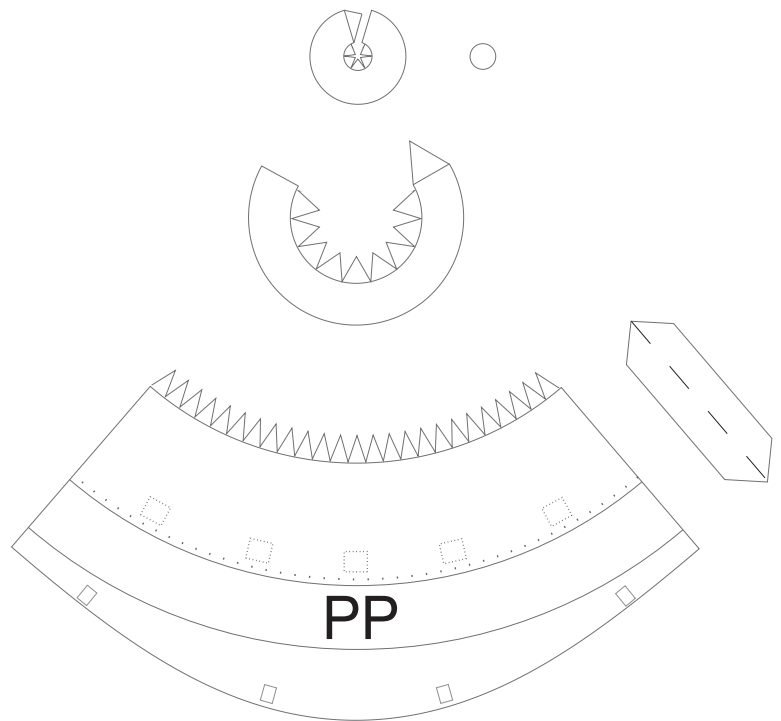

PP

Right



1 cm  
1 inch

1:96 Scale



# GSLV MK-III M1

Print on Cardstock ( 110 lb )

Left SRB

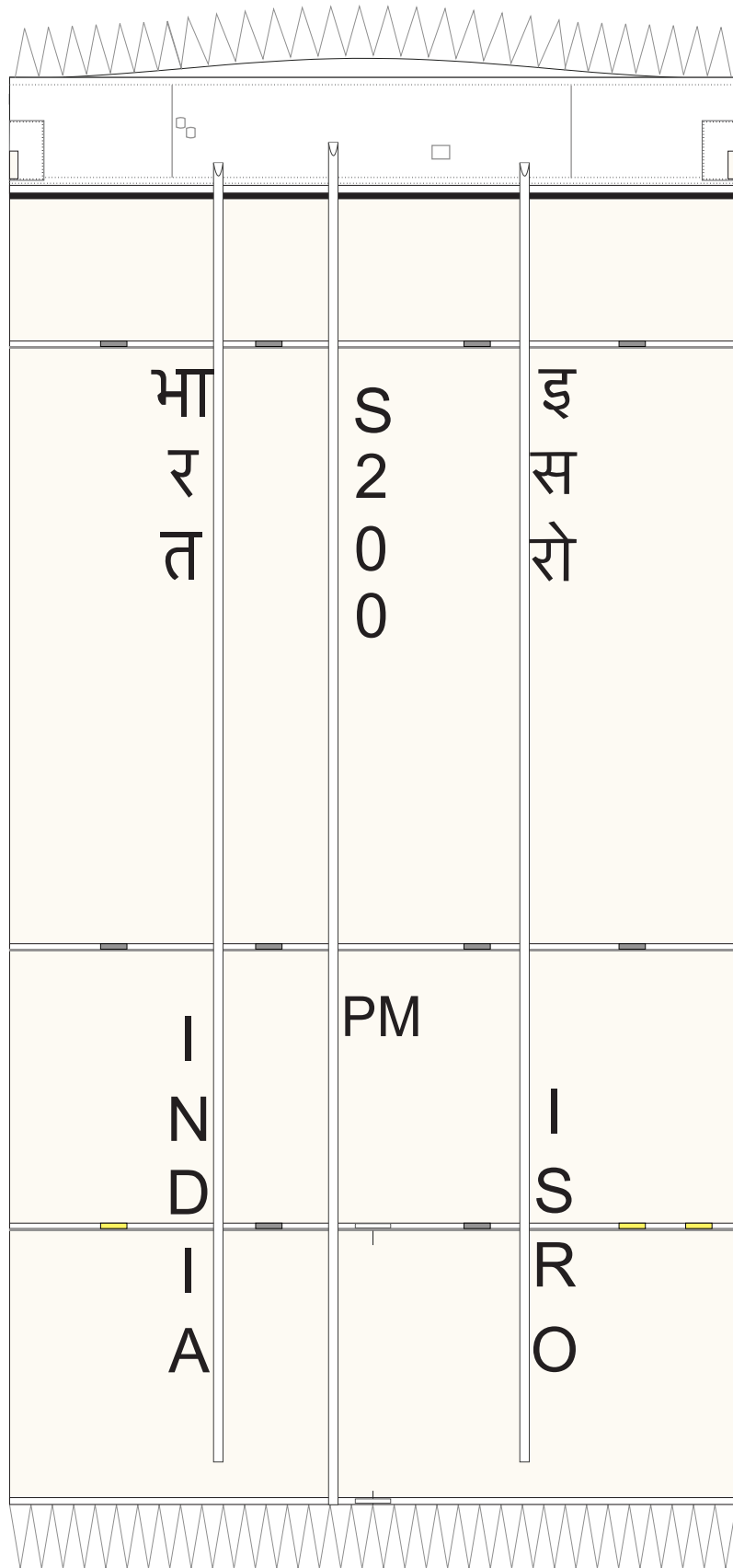

cut out  
yellow  
rectangles

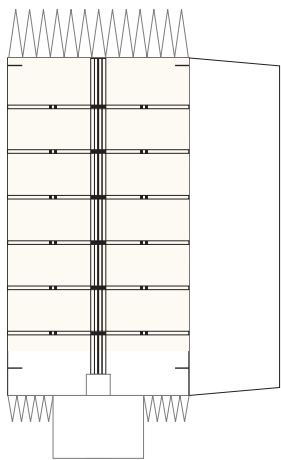
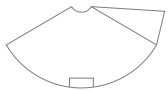





1 cm  
1 inch

1:96 Scale



# GSLV MK-III M1

Print on Cardstock ( 110 lb )

## Right SRB

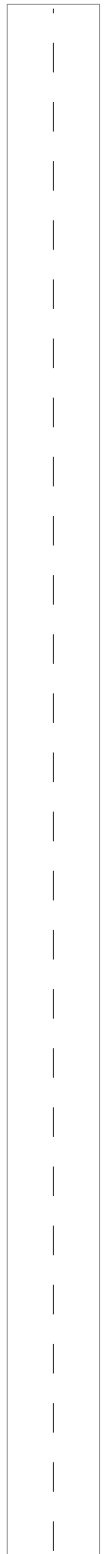
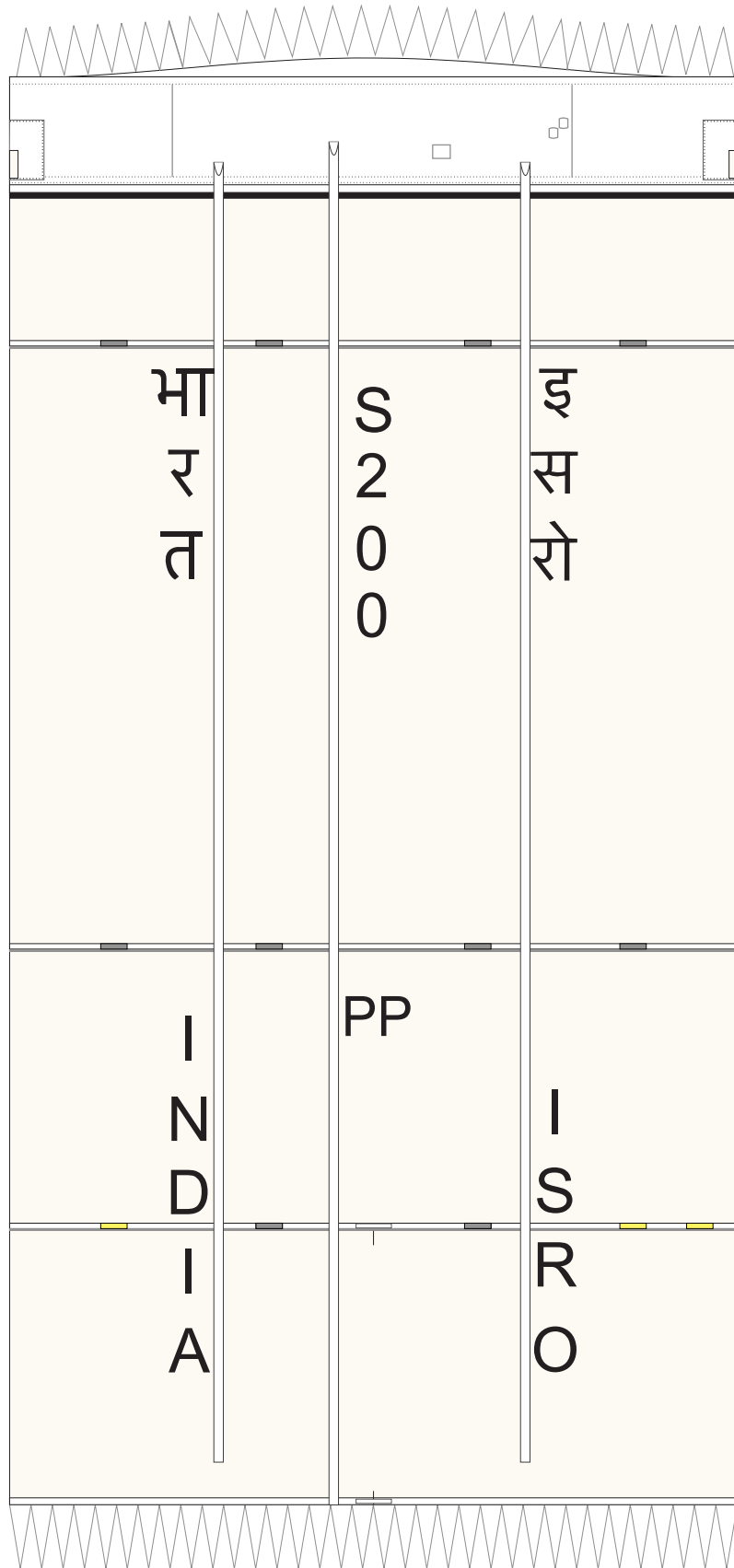

cut out yellow rectangles

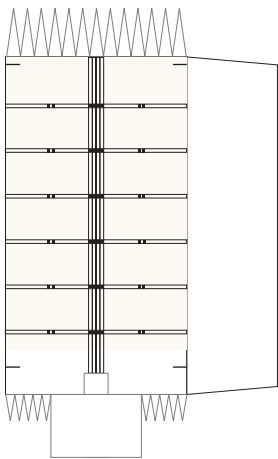
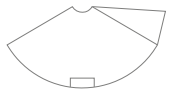



# Booster attachments

Print on Cardstock ( 110 lb )

1:96 Scale

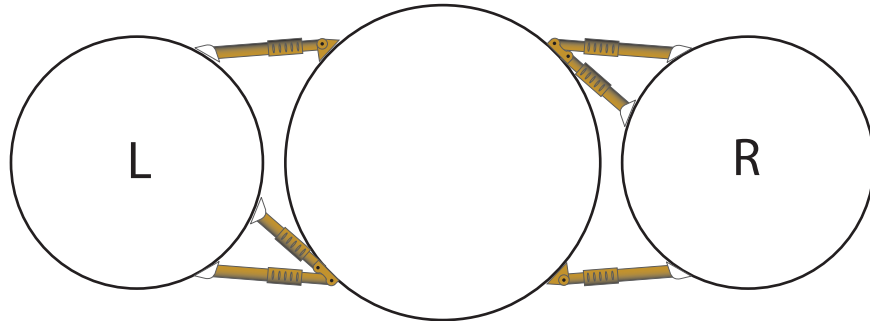

top	Left booster	bottom

bottom	Right booster	top



1 cm  
1 inch

# GSLV MK-III

Print on Cardstock ( 110 lb )

1:96 Scale

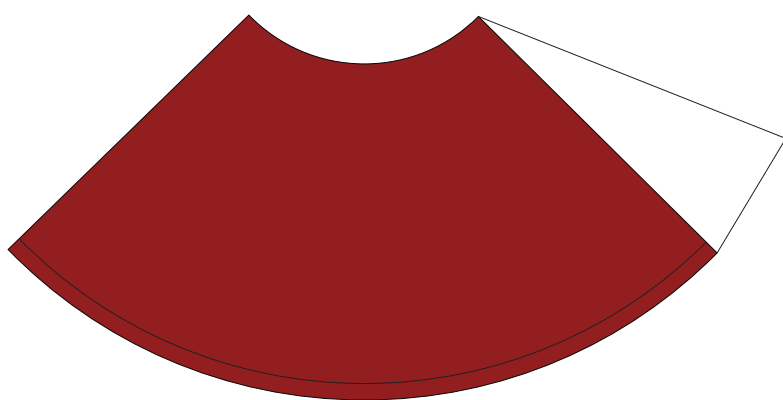
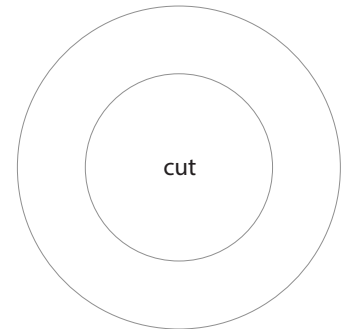
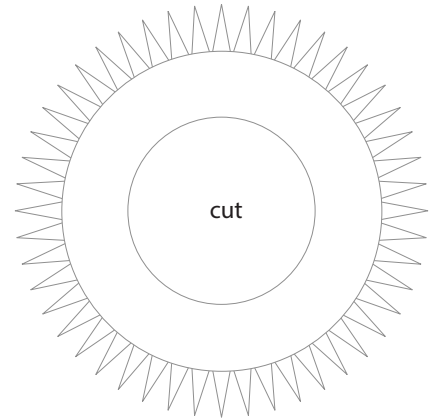
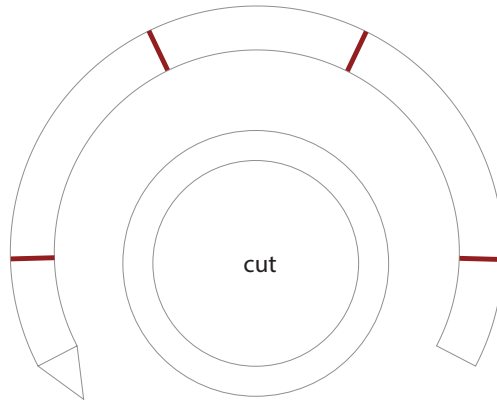
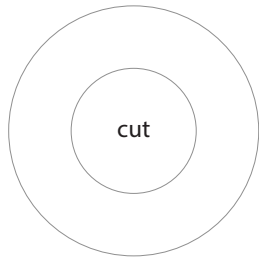
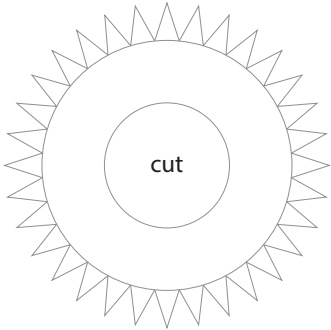
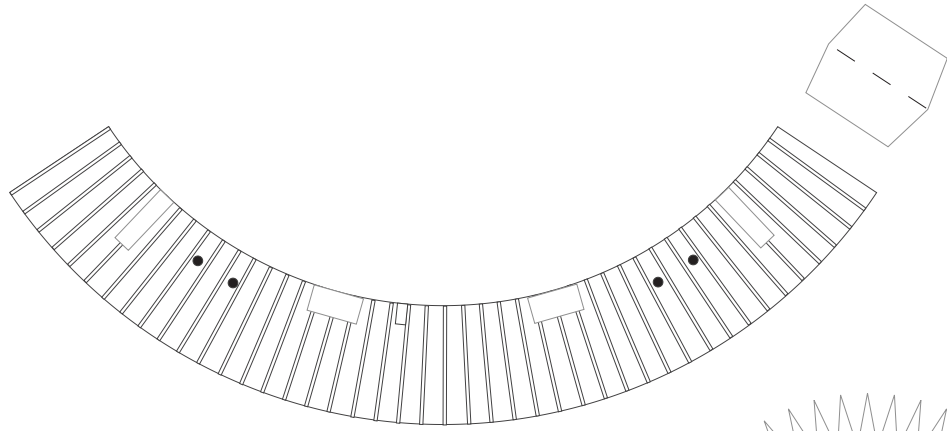



1 cm  
1 inch

# GSLV MK-III

Print on Cardstock ( 110 lb )

1:96 Scale

