



SPACE-X "Falcon-9 v1.1"

Print on Cardstock (110 lbs)

Fairing 1.0 Revision

DSCOVER

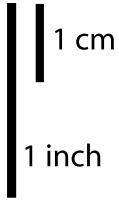

1:100 Scale

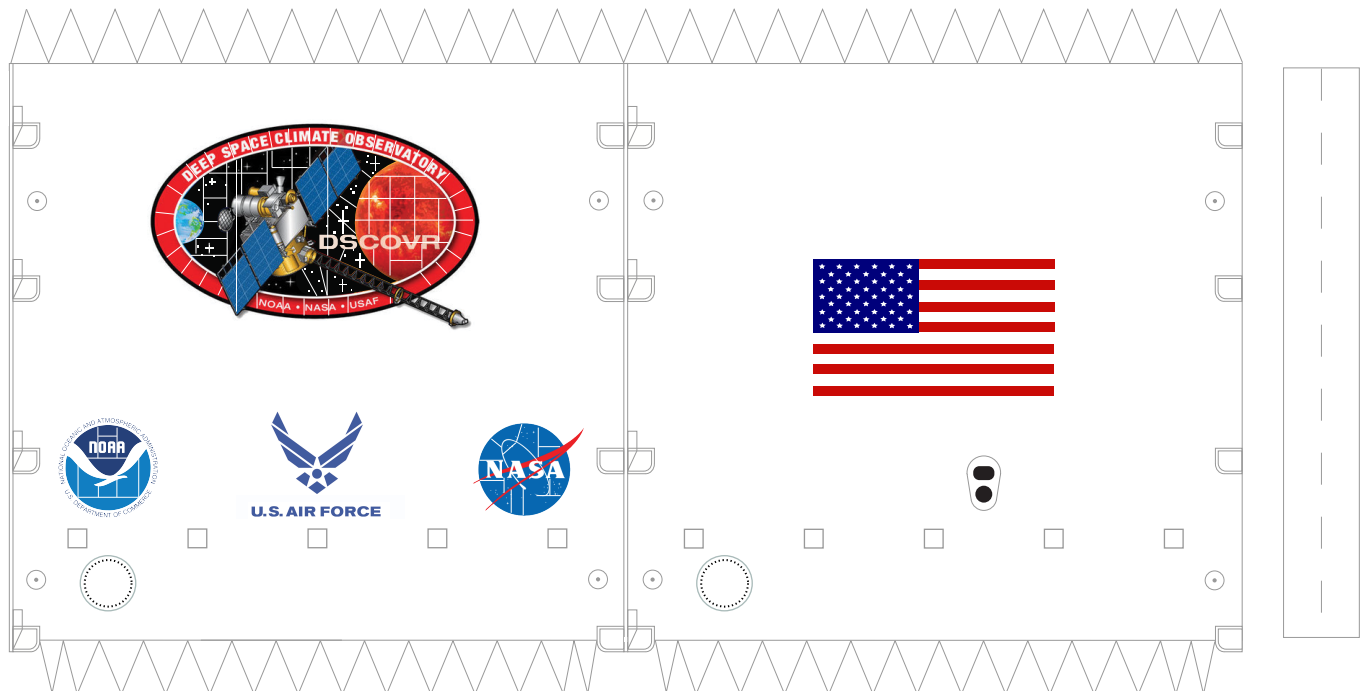
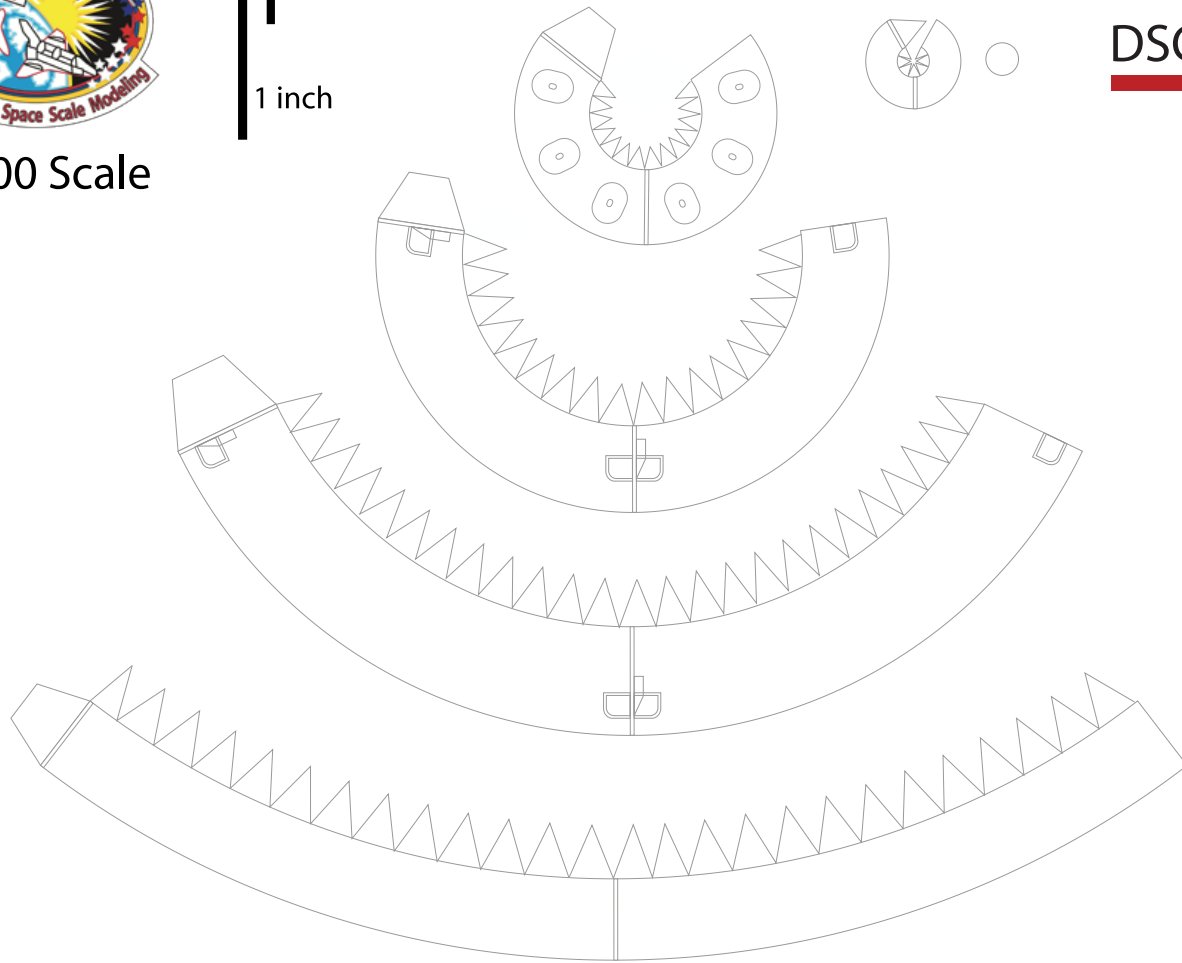



SPACE-X "Falcon-9 v1.1"

Print on Cardstock (110 lbs)

1 cm

1 inch

Grid Fins

1:100 Scale



Second Stage / Interstage

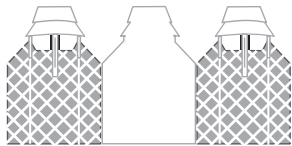
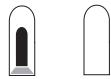
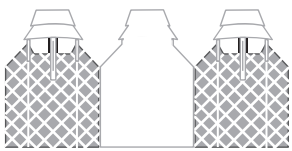
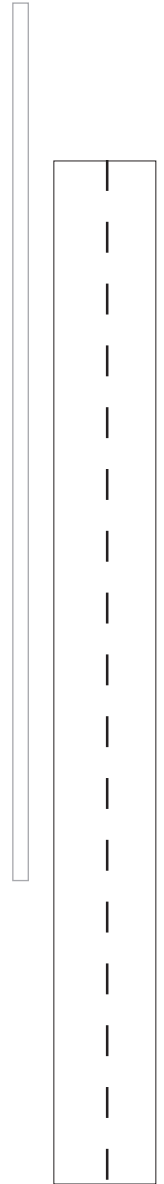
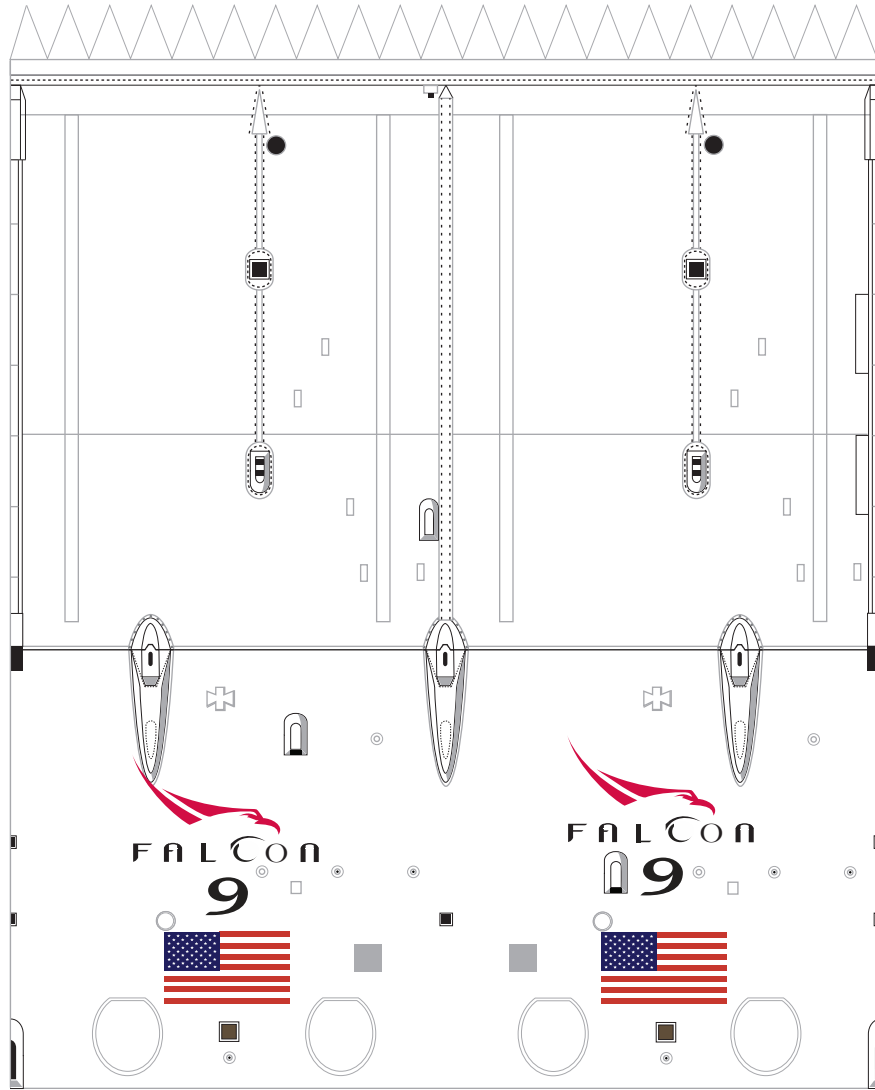
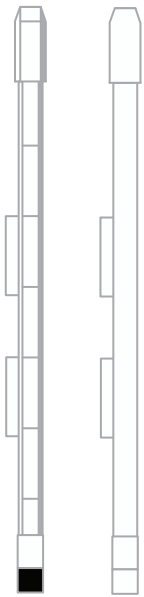

Grid Fins

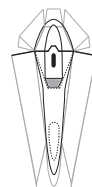
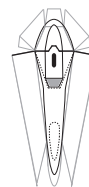
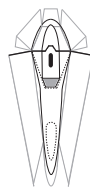
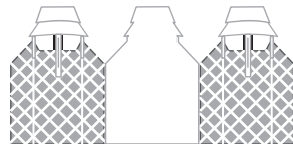
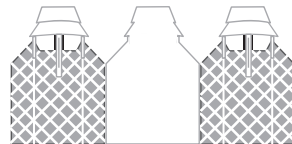



1:100 Scale



FALCON
9

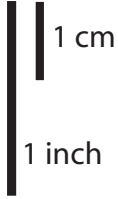

SPACE-X "Falcon-9 v1.1"

Print on Cardstock (110 lbs)

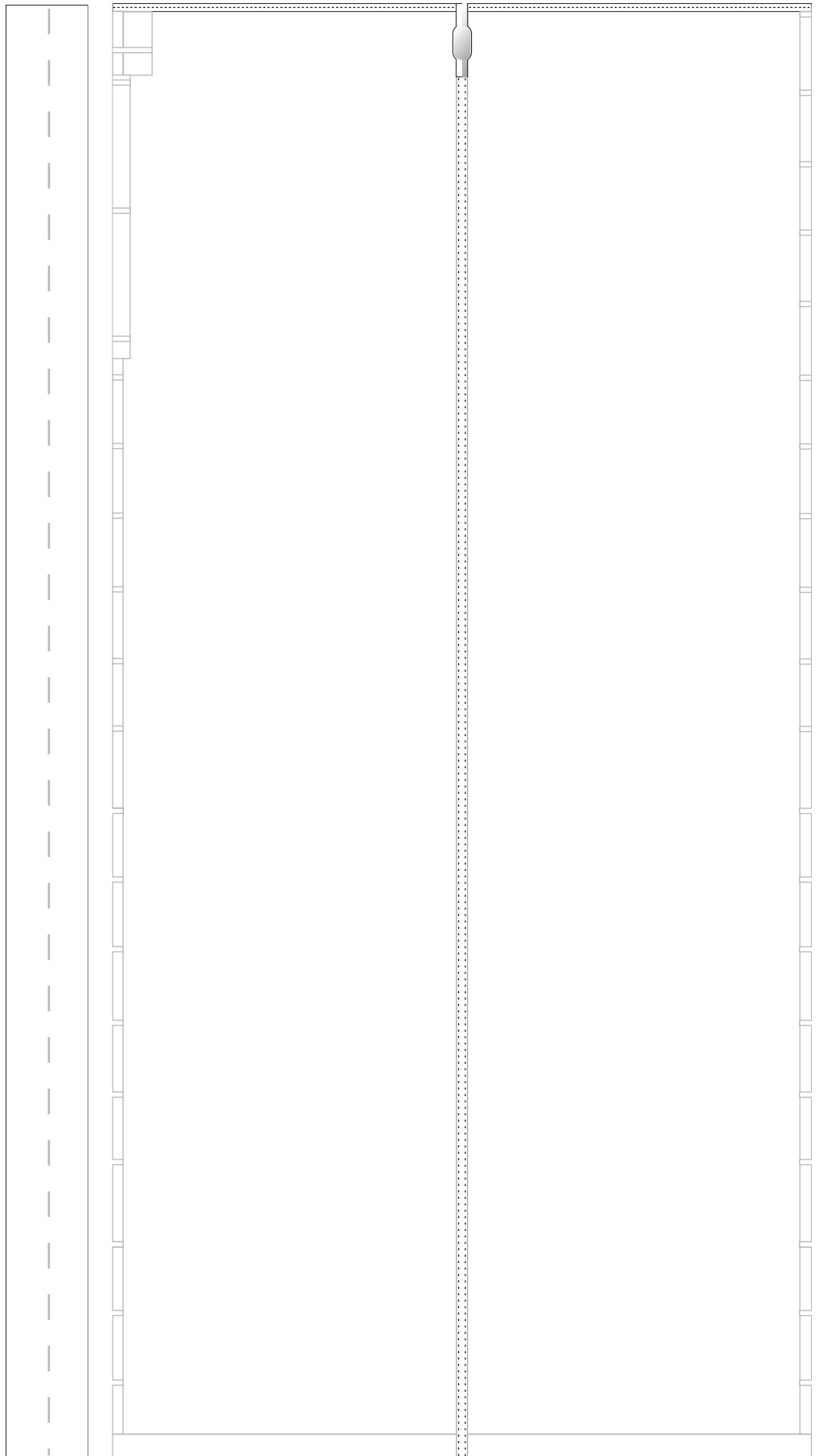
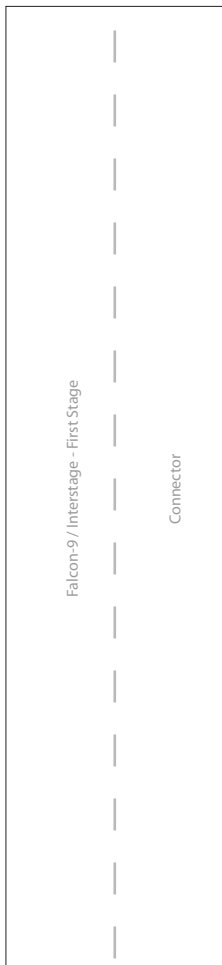



1:100 Scale



FALCON
9

SPACE-X "Falcon-9 v1.1"

Print on Cardstock (110 lbs)

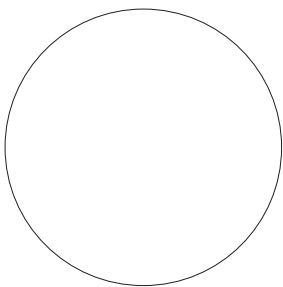
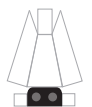
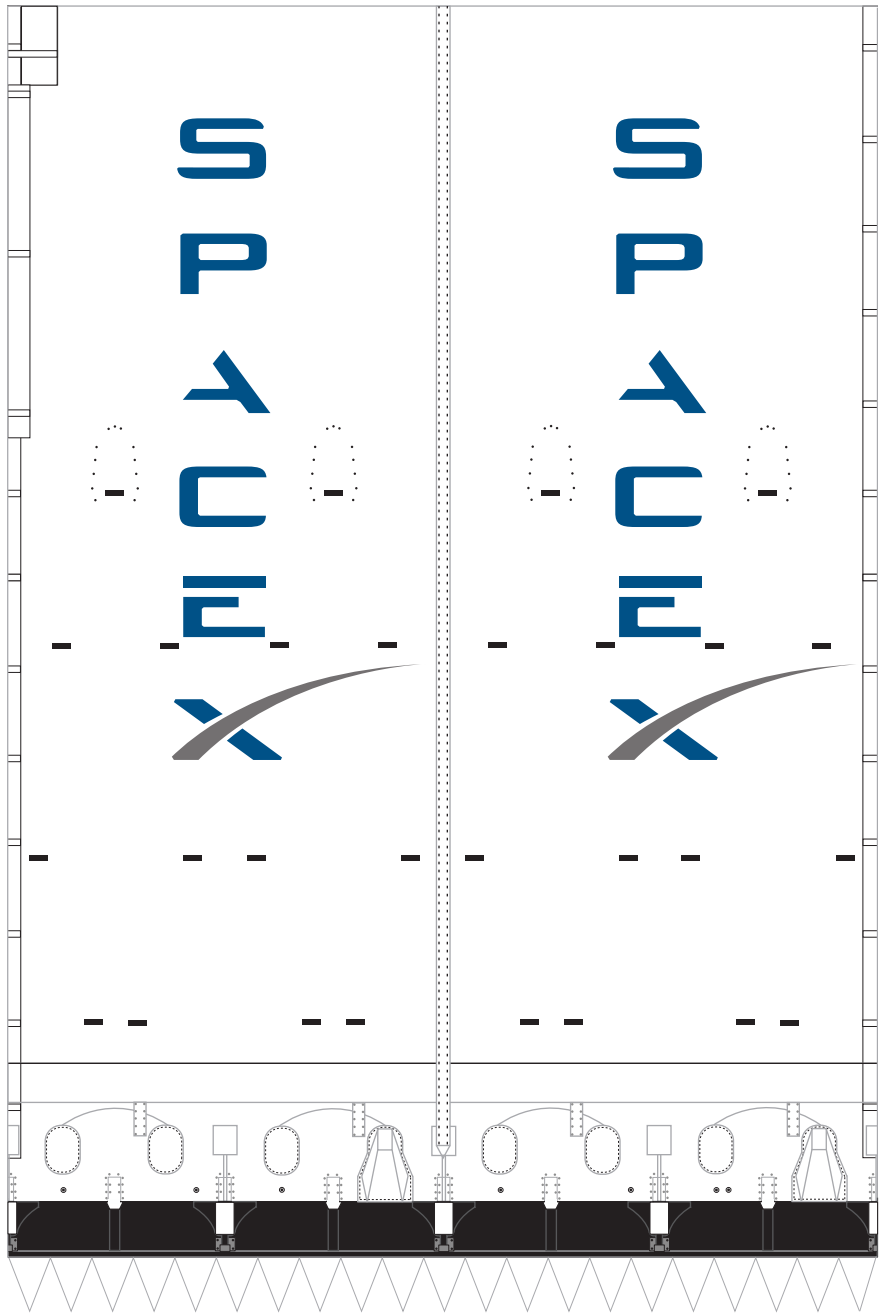
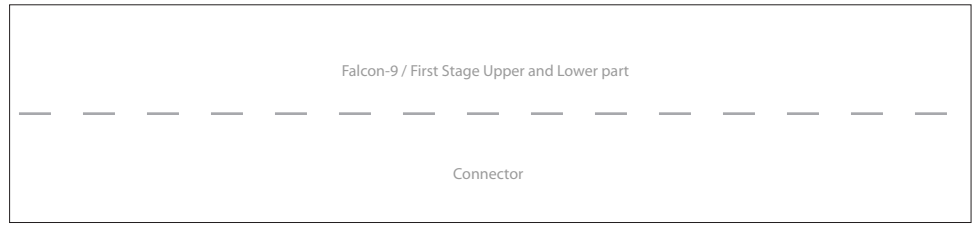
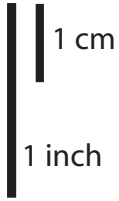



1:100 Scale

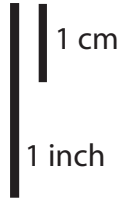

SPACE-X "Falcon-9 v1.1"

MERLIN Engines

Print on Cardstock (110 lbs)

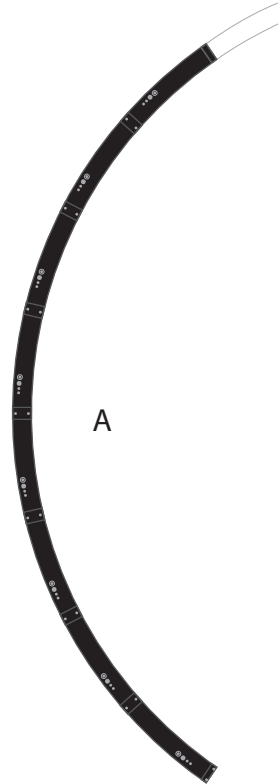
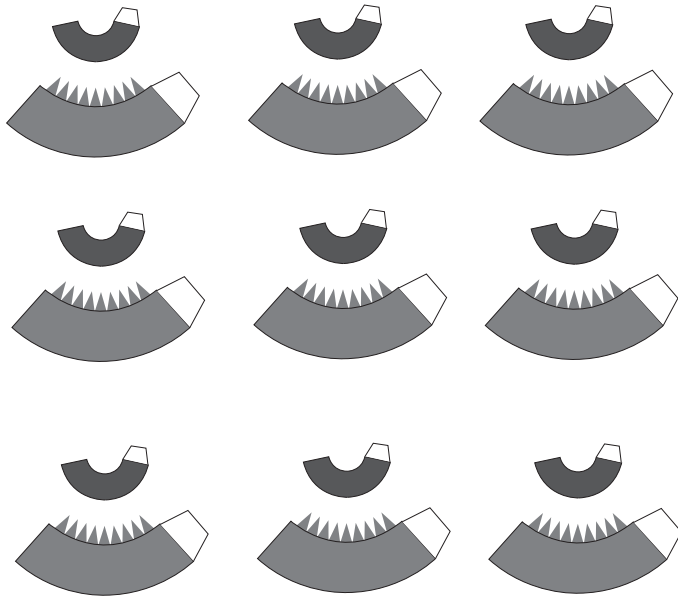

C

B

A

D

C

B

A

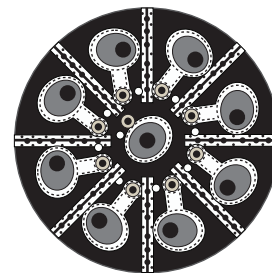
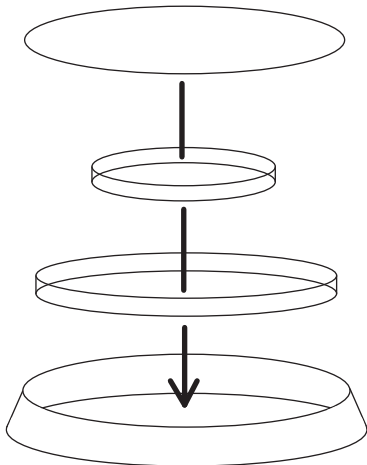

D

Engine Grid
OCTAWEB



1:100 Scale

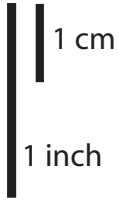

SPACE-X "Falcon-9 v1.1"

Print on Cardstock (110 lbs)

Umbilical Tray

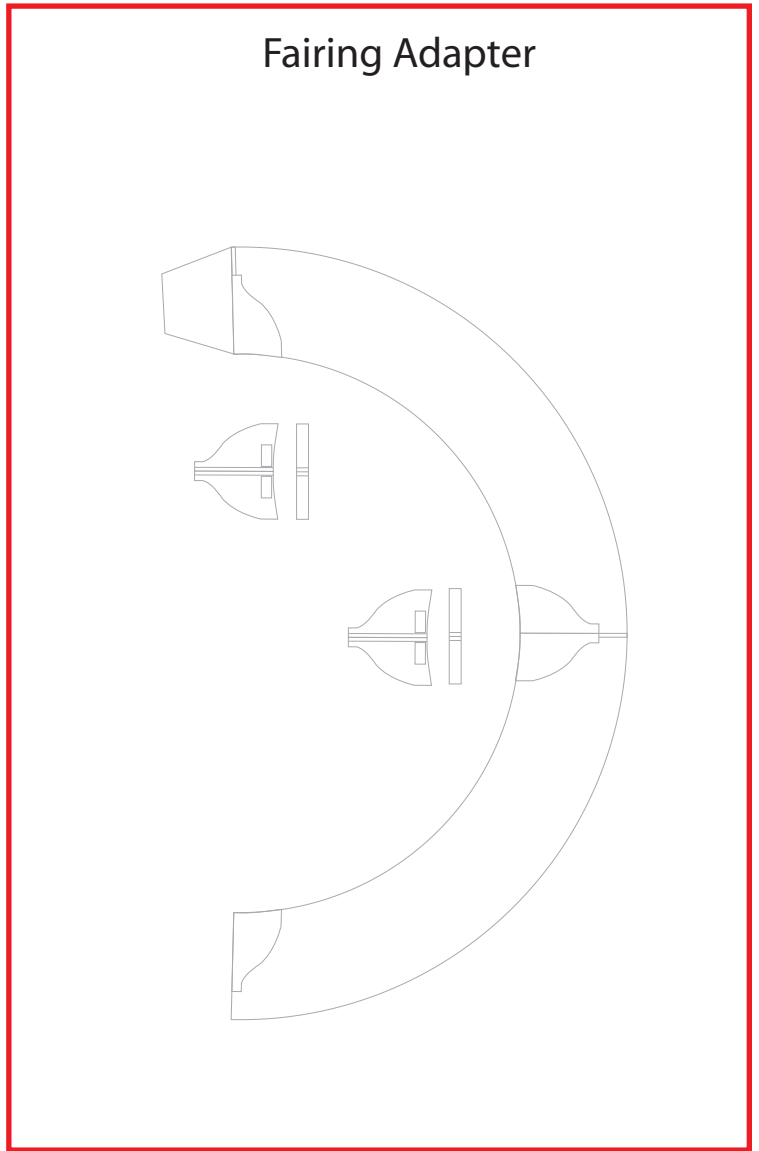
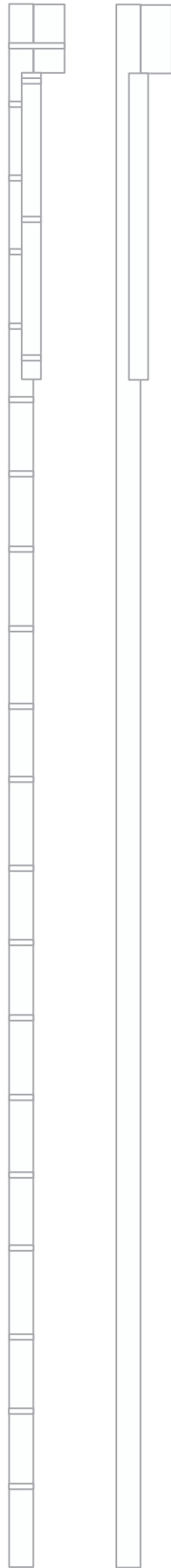
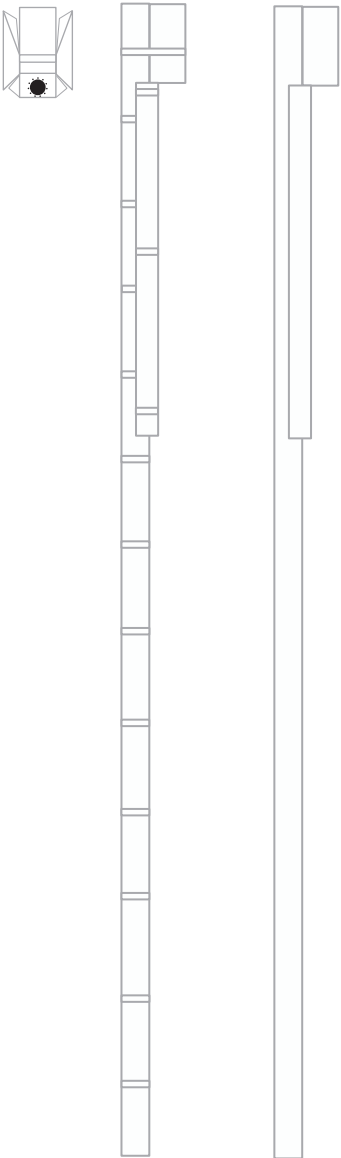
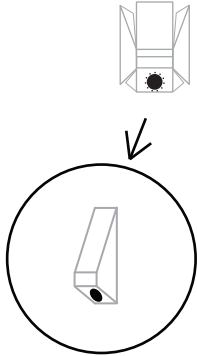



SPACE-X "Falcon-9 v1.1"

Print on Cardstock (110 lbs)

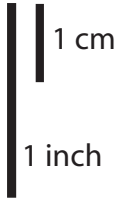

LEGS



1:100 Scale

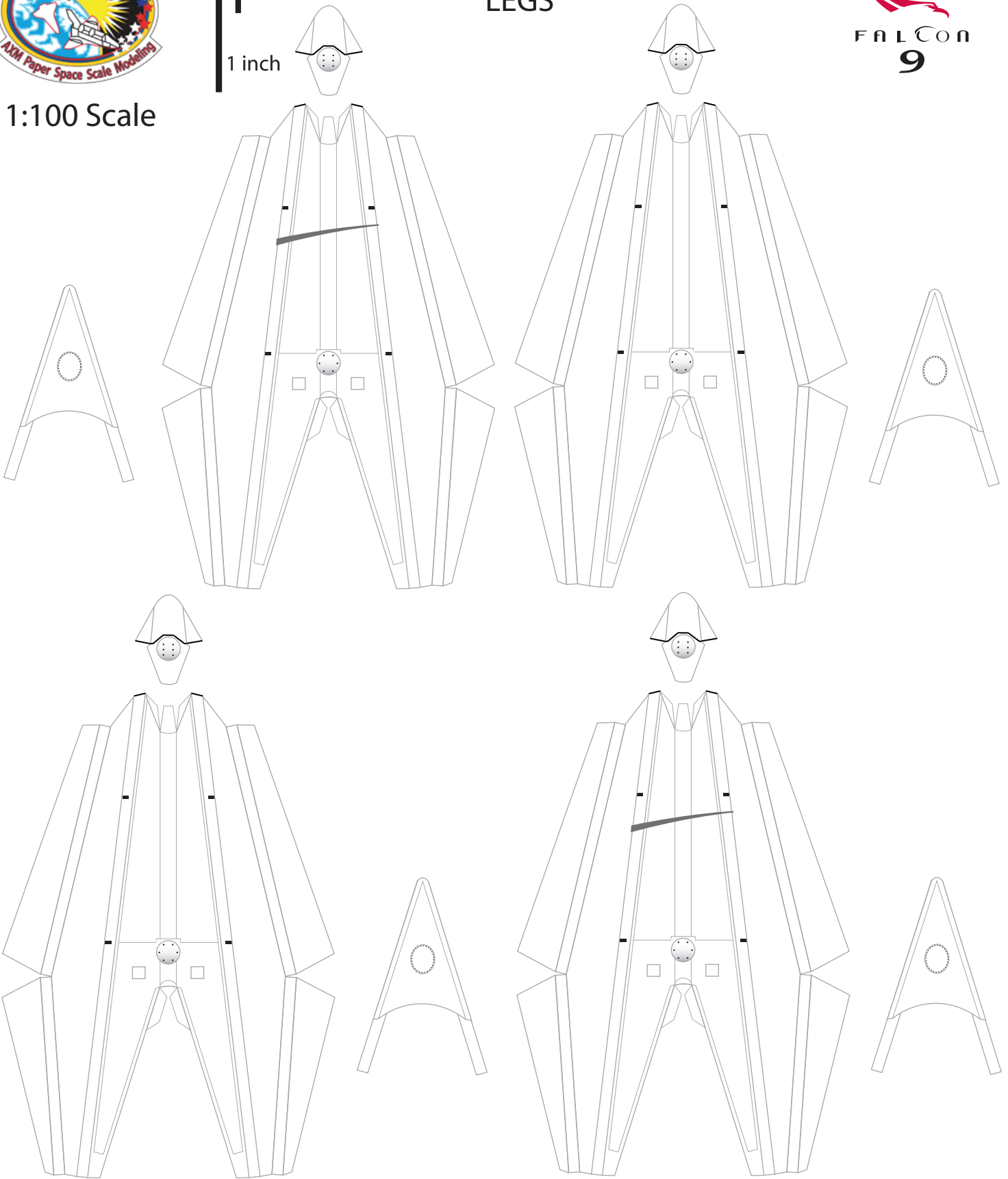



SPACE-X "Falcon-9 v1.1"

Print on Cardstock (110 lbs)

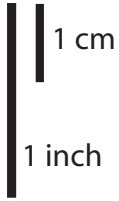

LEGS page 2



1:100 Scale

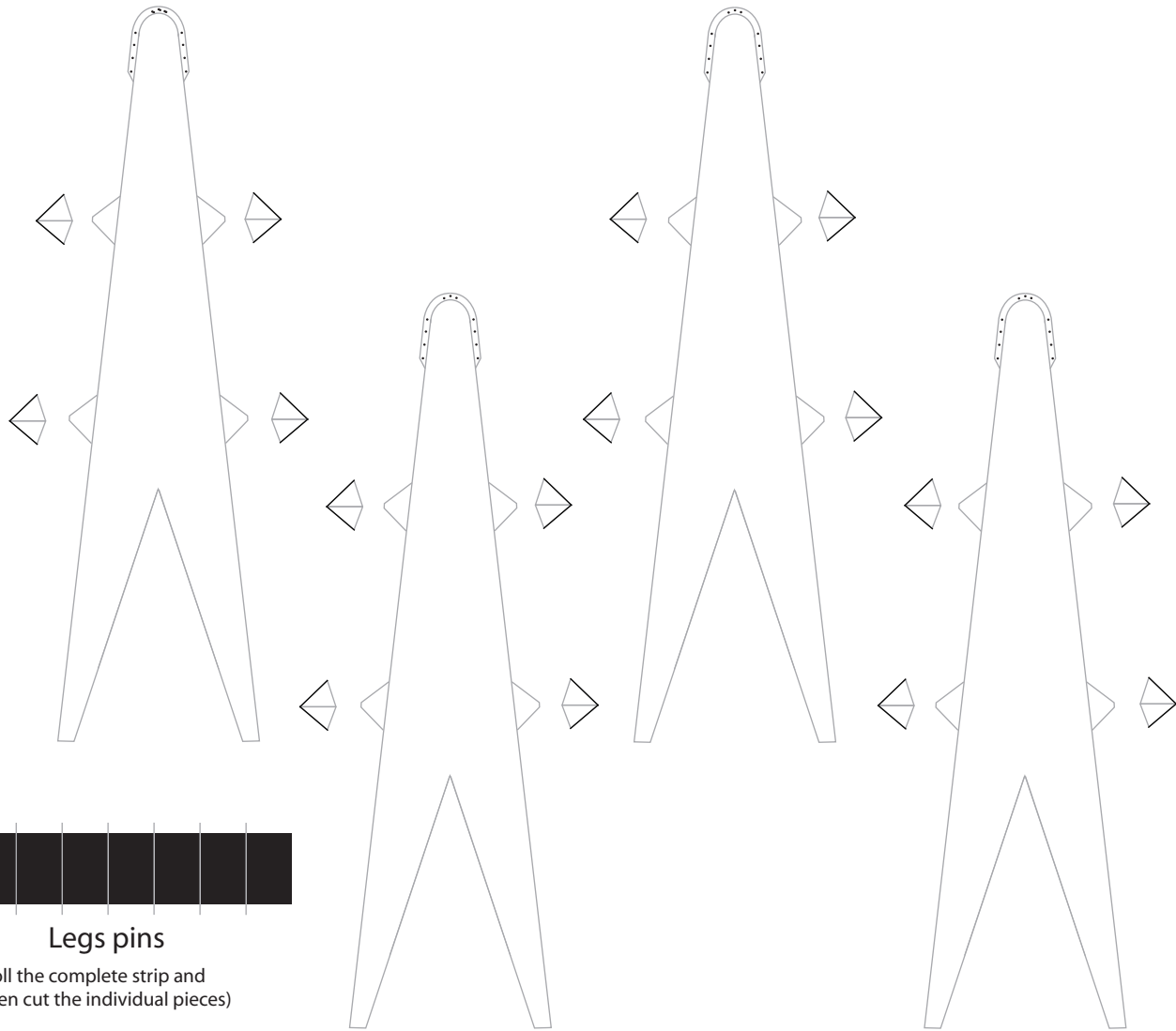

Legs pins

(roll the complete strip and then cut the individual pieces)

